



US00D845673S

(12) **United States Design Patent**  
**Dennehy**

(10) **Patent No.:** **US D845,673 S**  
(45) **Date of Patent:** **\*\* Apr. 16, 2019**

- (54) **BOAT SEAT CUSHION**
- (71) Applicant: **REGAL BOAT SEAT CUSHIONS INC.**, Wrentham, MA (US)
- (72) Inventor: **Martin J. Dennehy**, Wrentham, MA (US)
- (73) Assignee: **REGAL BOAT SEAT CUSHIONS INC.**, Wrentham, MA (US)

3,903,554 A 9/1975 Dodd  
 4,190,918 A 3/1980 Harvell  
 4,291,916 A 9/1981 Chardon  
 (Continued)

**FOREIGN PATENT DOCUMENTS**

GB 2165623 A 9/1985  
 GB 2502508 A 12/2013  
 JP 2010221861 A 10/2010

**OTHER PUBLICATIONS**

“Wise Deluxe Pontoon,” Restore Pontoon, restorepontoon.com, SKU: WD125-CO-xxxx, accessed: Jan. 15, 2016. <http://www.restorepontoon.com/pontoon/pc/viewPrd.asp?idproduct=3042>.

(Continued)

*Primary Examiner* — R. Johnson

(74) *Attorney, Agent, or Firm* — Kriegsman & Kriegsman

(57) **CLAIM**

I claim the ornamental design for a boat seat cushion, as shown and described.

**DESCRIPTION**

FIG. 1 is a rear perspective view of a boat seat cushion showing my new design;  
 FIG. 2 is a top view thereof;  
 FIG. 3 is a bottom view thereof;  
 FIG. 4 is a left side view thereof;  
 FIG. 5 is a right side view thereof;  
 FIG. 6 is a rear view thereof;  
 FIG. 7 is a front view thereof; and,  
 FIG. 8 is a right side view showing the boat seat cushion of FIG. 1 secured to a boat seat.  
 The dashed lines in FIGS. 1-3 and FIGS. 6-7 represent stitching and are part of the claimed design. The broken lines shown in FIG. 8 are directed to the environment in which the present invention is used, such broken lines in FIG. 8 being for illustrative purposes only and forming no part of the design to be patented.

**1 Claim, 8 Drawing Sheets**

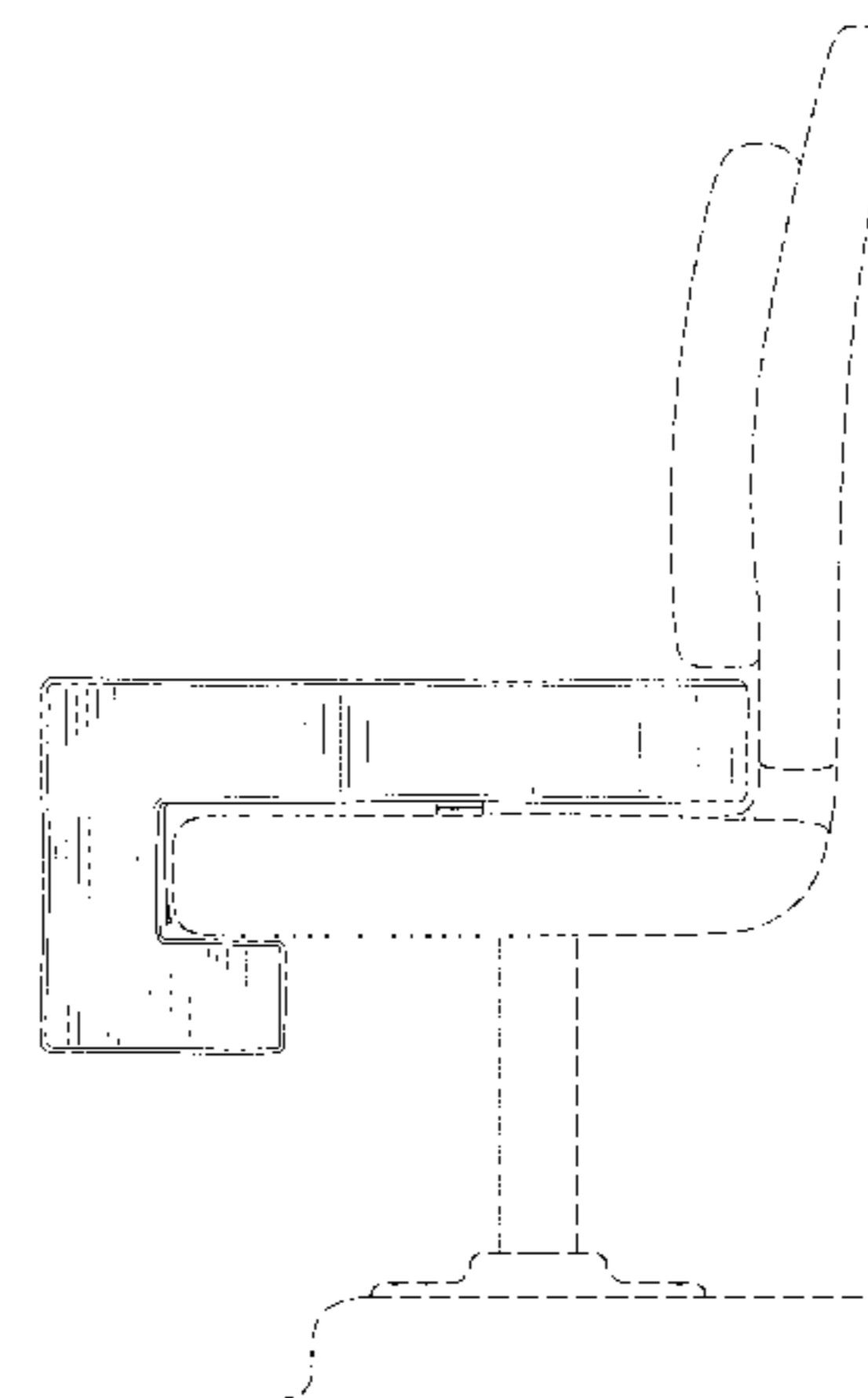
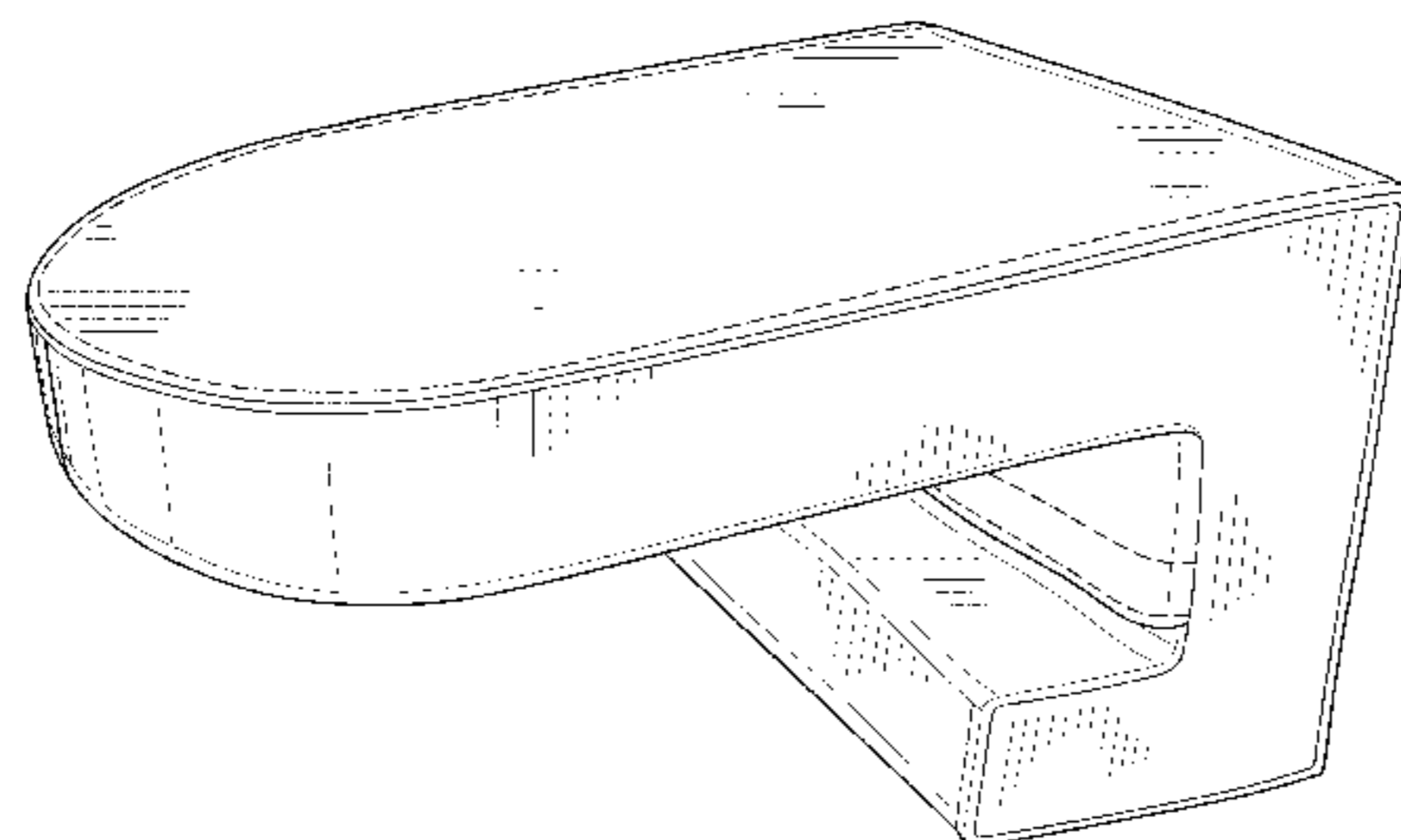
**Related U.S. Application Data**

- (63) Continuation-in-part of application No. 15/646,457, filed on Jul. 11, 2017.
- (51) **LOC (11) Cl.** ..... **06-09**
- (52) **U.S. Cl.**  
USPC ..... **D6/601**
- (58) **Field of Classification Search**  
USPC ..... D6/595, 596, 601, 716.5; 5/632, 633, 5/636, 648, 652, 655.9, 656, 948-953  
CPC ..... A47G 9/00; A47G 9/10; A47G 9/1045; A47G 9/1054; A47G 9/1063; A47G 9/1072; A47G 9/1081; A47G 9/109; A47G 1009/1027; A47G 2009/1018; A47C 27/001; A47C 7/021; A47C 7/022; A47C 7/18  
See application file for complete search history.

(56) **References Cited**

**U.S. PATENT DOCUMENTS**

2,782,840 A 2/1957 Armbrecht  
 3,046,573 A \* 7/1962 Davis, Sr. .... B60N 2/787  
 3,369,262 A 2/1968 Judd  
 5/652



(56)

References Cited

U.S. PATENT DOCUMENTS

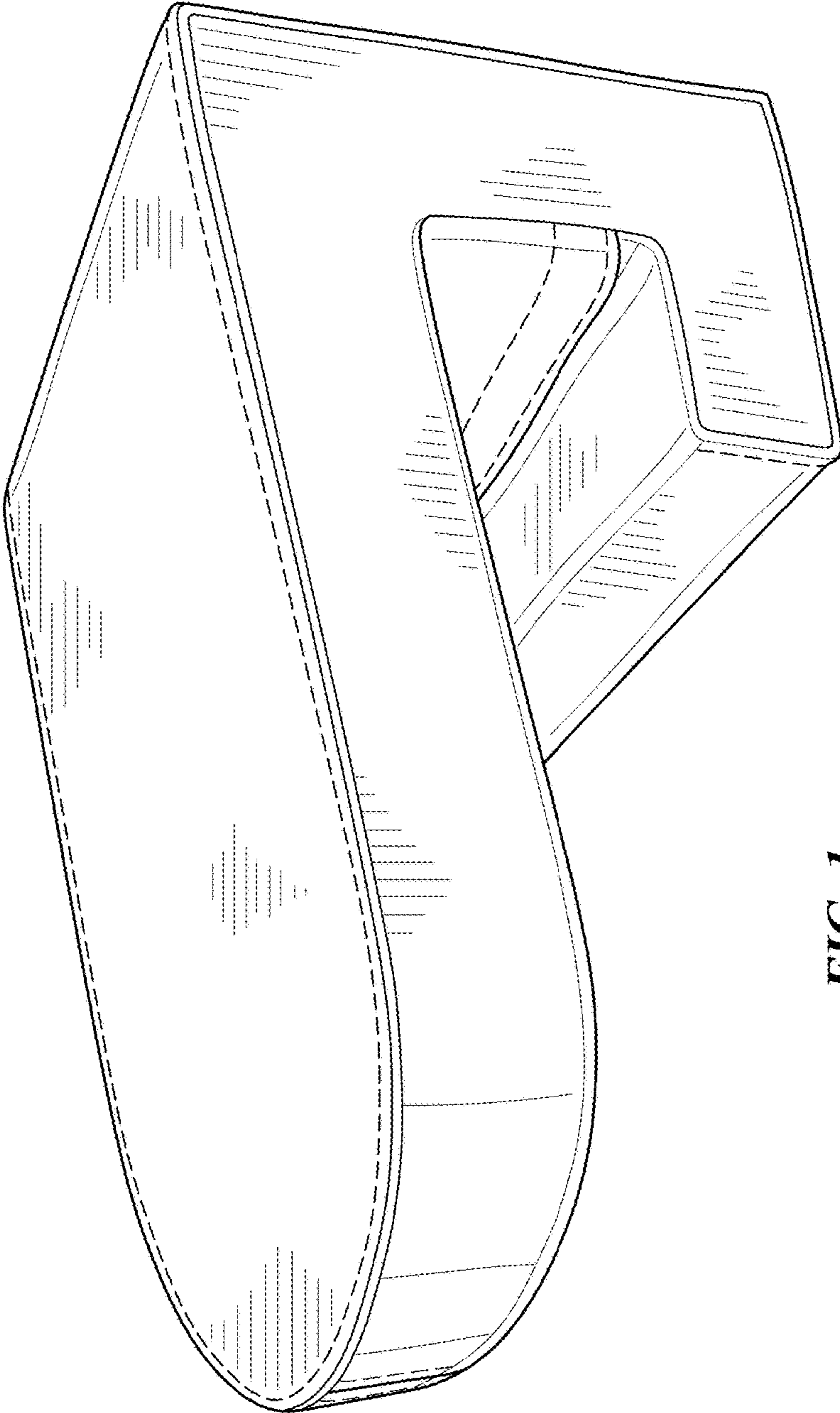
4,789,046 A 12/1988 McDowall  
 4,802,249 A 2/1989 Bills  
 4,926,783 A 5/1990 Lathers  
 D315,076 S 3/1991 Hanna  
 D315,993 S 4/1991 Wenderoth  
 5,029,928 A 7/1991 Huber  
 5,042,093 A 8/1991 Legendre  
 D324,769 S 3/1992 Hart  
 D324,970 S 3/1992 Kane  
 D328,001 S \* 7/1992 Kelly ..... D6/707  
 5,171,063 A 12/1992 Stidd  
 D336,791 S 6/1993 Stidd  
 5,325,456 A 6/1994 Cullen et al.  
 D362,579 S 9/1995 Short  
 D366,383 S 1/1996 Briegleb  
 D366,800 S 2/1996 Moore, Jr.  
 5,491,851 A 2/1996 Alonso  
 D376,701 S 12/1996 Thompson  
 5,619,949 A 4/1997 Dick, Jr.  
 D379,047 S 5/1997 Richard  
 D381,855 S 8/1997 Galick  
 D382,756 S 8/1997 Ryan  
 5,857,423 A 1/1999 Imaeda et al.  
 5,950,263 A 9/1999 Hanson et al.  
 D462,862 S \* 9/2002 Thayer, Jr. .... D6/601  
 D463,701 S 10/2002 Borcharding et al.  
 D474,934 S \* 5/2003 Ildstad ..... D6/601  
 D503,867 S 4/2005 Bennette et al.  
 D572,069 S \* 7/2008 McQueen ..... D6/611  
 D575,536 S \* 8/2008 Bizzell ..... D6/333  
 7,523,988 B1 4/2009 Ratza et al.  
 D602,298 S 10/2009 Zwanzgleitner et al.  
 D634,951 S 3/2011 Dreiling  
 D635,265 S 3/2011 Coffey et al.  
 8,336,965 B2 12/2012 Kismarton et al.  
 D677,506 S 3/2013 Lai  
 D695,548 S 12/2013 Johnson  
 D696,532 S 12/2013 von Saher  
 D702,979 S 4/2014 Jannetides et al.  
 8,695,136 B2 4/2014 Pozzi  
 8,702,120 B2 4/2014 Kalisz et al.  
 8,782,835 B2 7/2014 Pozzi  
 D713,664 S 9/2014 Vetter et al.  
 8,910,330 B1 \* 12/2014 Malik ..... A47G 9/109  
 5/636  
 D725,923 S \* 4/2015 Kaye ..... D6/349  
 D725,924 S 4/2015 Kaye  
 D725,925 S 4/2015 Kaye  
 9,045,197 B2 6/2015 Chen  
 D737,073 S 8/2015 Hawkins  
 D740,043 S 10/2015 Lee  
 D747,117 S 1/2016 Lau  
 D749,873 S 2/2016 Latrofa  
 D769,028 S 10/2016 Little

D775,484 S \* 1/2017 Moore ..... D6/601  
 D790,235 S \* 6/2017 Chuah ..... D6/333  
 D823,025 S \* 7/2018 Dennehy ..... D6/601  
 2005/0138733 A1 6/2005 Riesberg et al.  
 2005/0177944 A1 8/2005 Kang et al.  
 2007/0001503 A1 1/2007 Brady  
 2008/0315644 A1 12/2008 Briscoe  
 2010/0037814 A1 2/2010 Sahr et al.  
 2012/0256466 A1 10/2012 Lievestro et al.  
 2013/0263377 A1 10/2013 Woollen, Jr.  
 2015/0359353 A1 12/2015 Vainberg et al.  
 2016/0192794 A1 7/2016 Boyd  
 2016/0296031 A1 10/2016 Sramek  
 2016/0338514 A1 11/2016 Chan  
 2017/0320551 A1 \* 11/2017 Dennehy ..... B63B 29/04

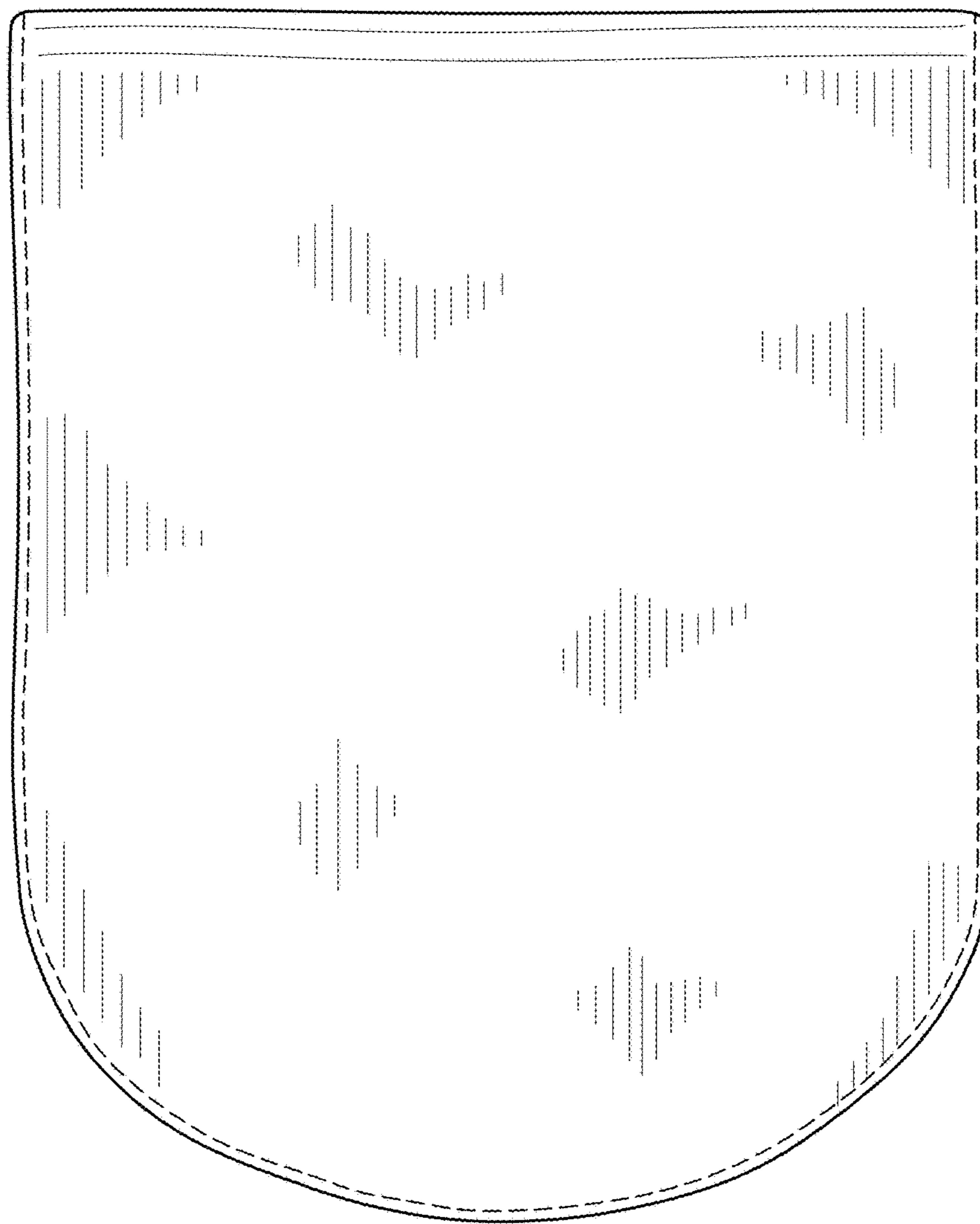
OTHER PUBLICATIONS

“Ladder Back Pilot Chair 1095 with Cushions, 15" Fixed Pedestal and Seat Slide—Wise Boat Seats,” iboats™, iboats.com, Part # WD1095-710, Jan. 15, 2016. [http://www.iboats.com/Ladder-Back-Pilot-Chair-1095-with-Cushions-15-Fixed-Pedestal-and-Seat-Slide-Wise-Boat-Seats/dm/cart\\_id.464238942--session\\_id.419910167--view.jd.375626](http://www.iboats.com/Ladder-Back-Pilot-Chair-1095-with-Cushions-15-Fixed-Pedestal-and-Seat-Slide-Wise-Boat-Seats/dm/cart_id.464238942--session_id.419910167--view.jd.375626).  
 “Deluxe Off White/Charcoal Vinyl Boat Bolster/Bucket/Drivers Seating Seat Chairs (Pair),” Great Lakes Skipper™, greatlakesskipper.com, GLS Stock #: 1045989, Part #: M2540BB00307, Jan. 15, 2016 <http://greatlakesskipper.com/deluxe-off-white-charcoal-vinyl-boat-bolster-bucket-drivers-seating-seat-chairs-pair>.  
 Jim Buoy Flotation Cushion, available at least on Aug. 27, 2013, [online], [site visited Aug. 2, 2017]. Available from Internet, <URL:<http://www.defender.com/category.jsp?path=1%7C135%7C2290066&id=2290114>>.  
 U.S. Appl. No. 29/563,721, inventor Martin J. Dennehy, filed May 6, 2016.  
 U.S. Appl. No. 29/563,731, inventor Martin J. Dennehy, filed May 6, 2016.  
 U.S. Appl. No. 29/627,592, inventor Martin J. Dennehy, filed Nov. 28, 2017.  
 U.S. Appl. No. 29/630,607, inventor Martin J. Dennehy, filed Dec. 21, 2017.  
 Millennium ComfortMax SW-200 Saltwater Casting Boat Seat, accessed Oct. 2, 2017, <http://www.basspro.com/shop/en/millennium-comfortmax-sw-200-saltwater-casting-boat-seat>.  
 Millennium ComfortMax SW-200 Saltwater Casting Boat Seat, accessed Dec. 22, 2017, <http://www.millenniummarine.com/sw-series/sw-200/sw-200-white/>.  
 Tempress Guide Series Casting Seat, accessed Oct. 2, 2017, <http://www.basspro.com/shop/en/tempress-guide-series-casting-seat>.  
 Tempress Guide Series Casting Seat, accessed Dec. 22, 2017, <https://tempress.com/store/TEMPRESS-Guide-Series-Casting-Seat-Blue-Gray-p36736269>.

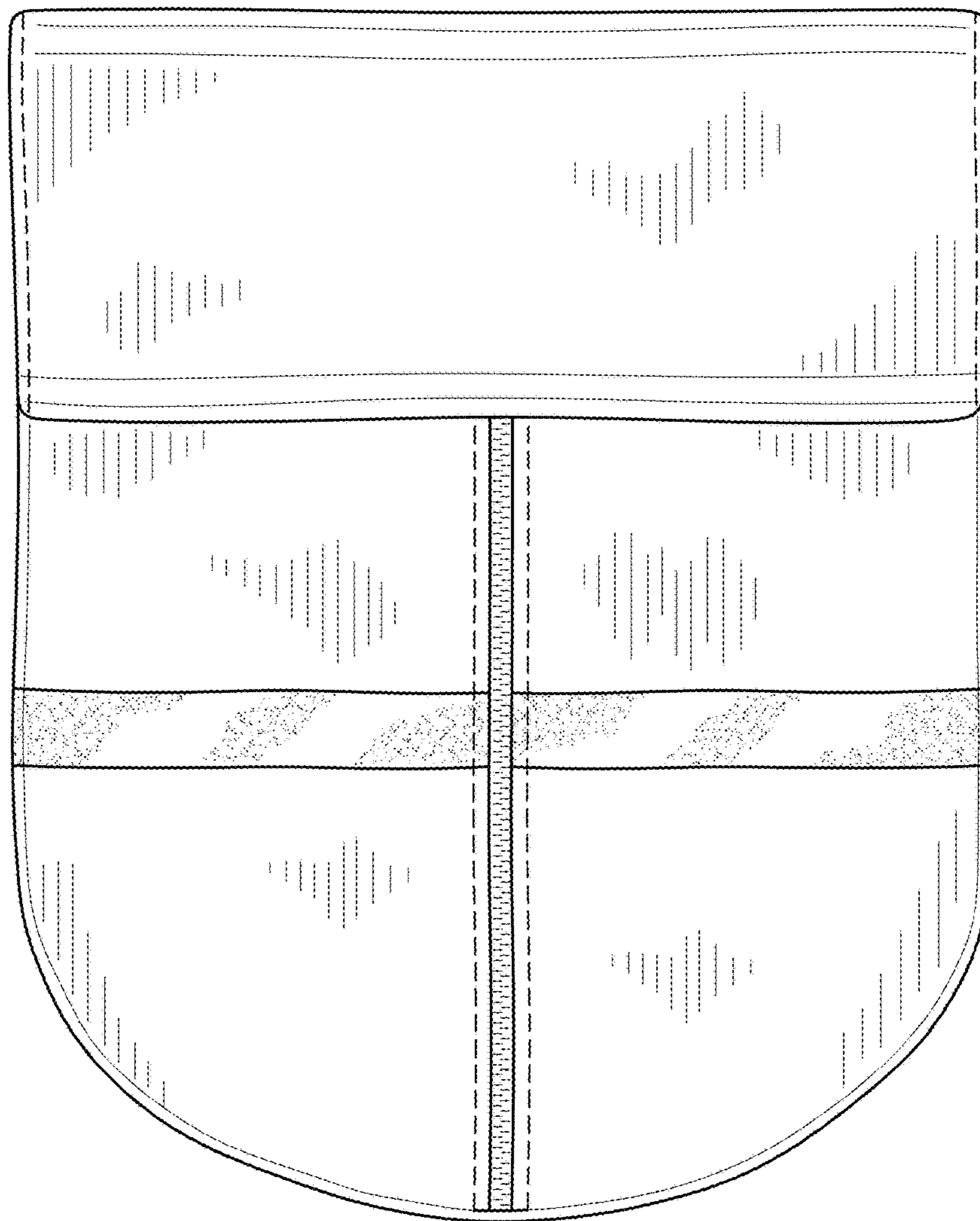
\* cited by examiner



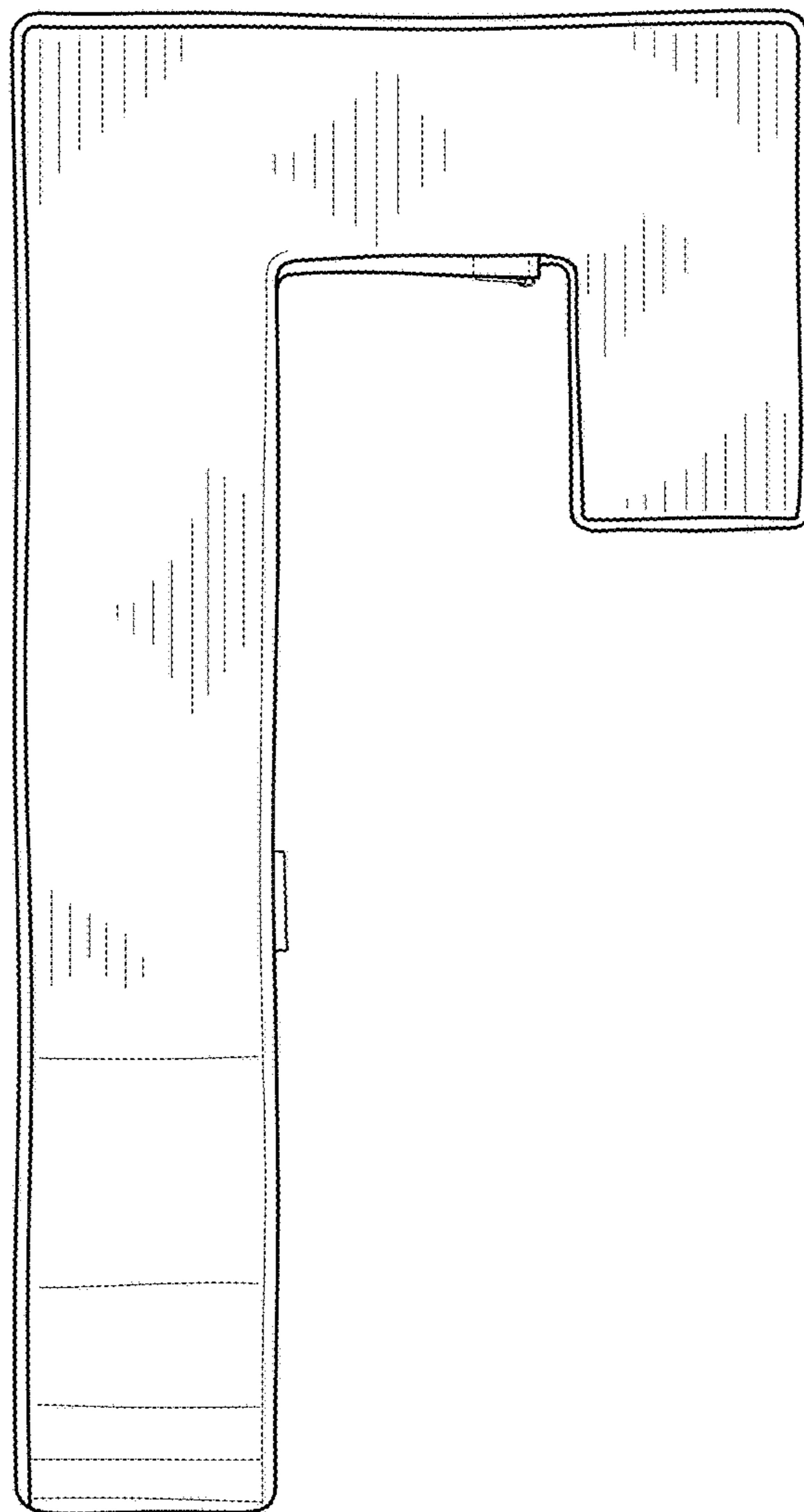
**FIG. 1**



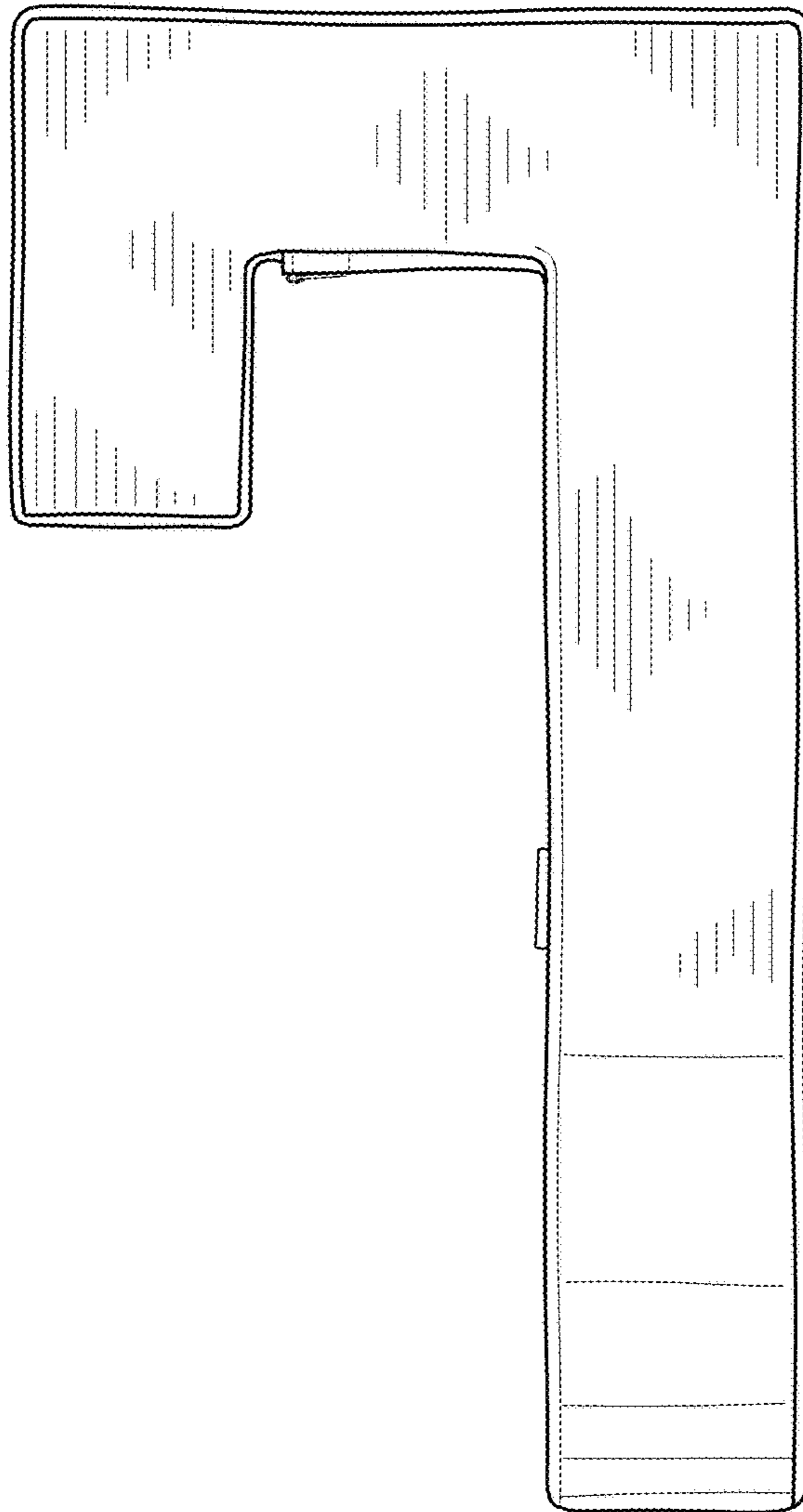
**FIG. 2**



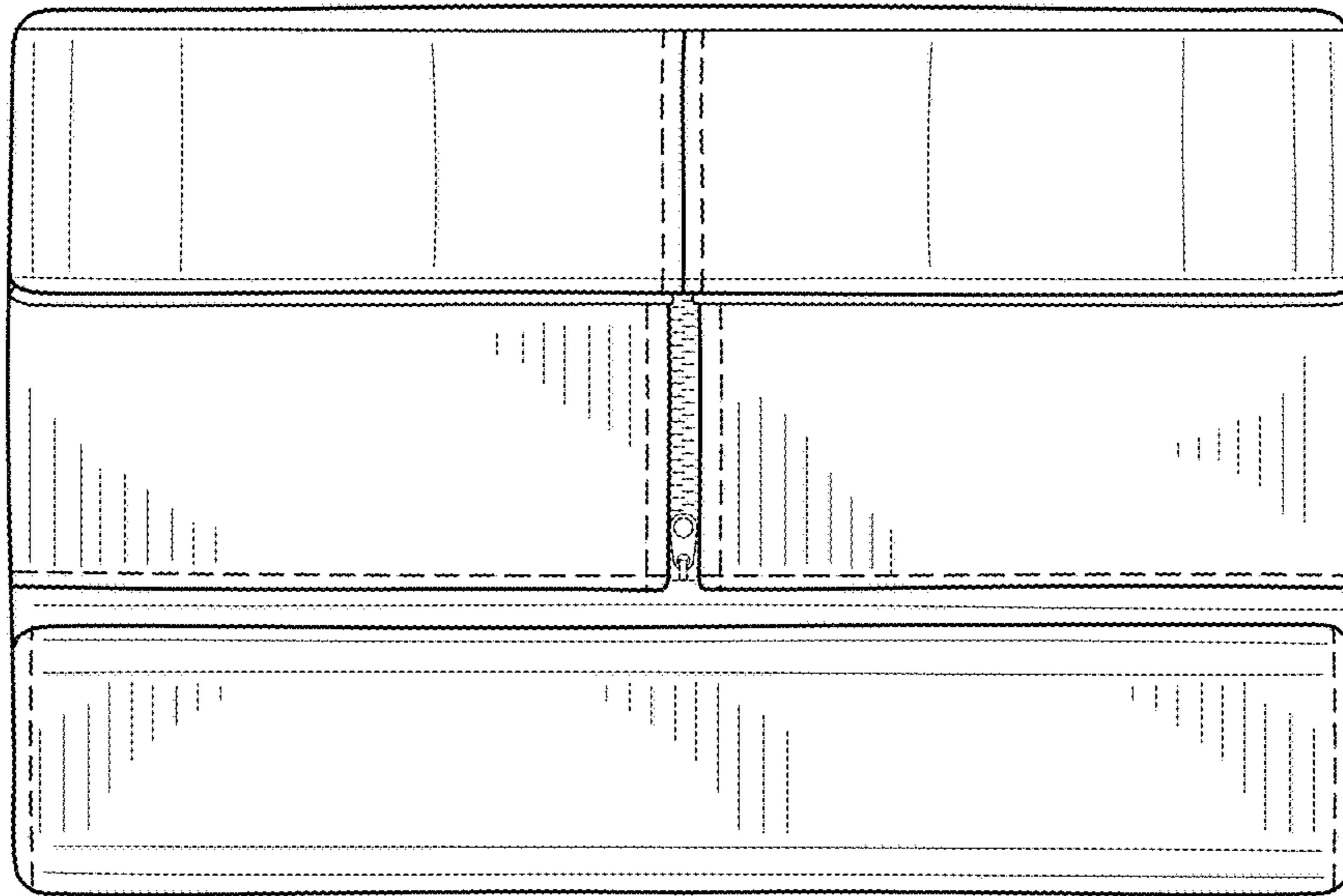
**FIG. 3**



**FIG. 4**

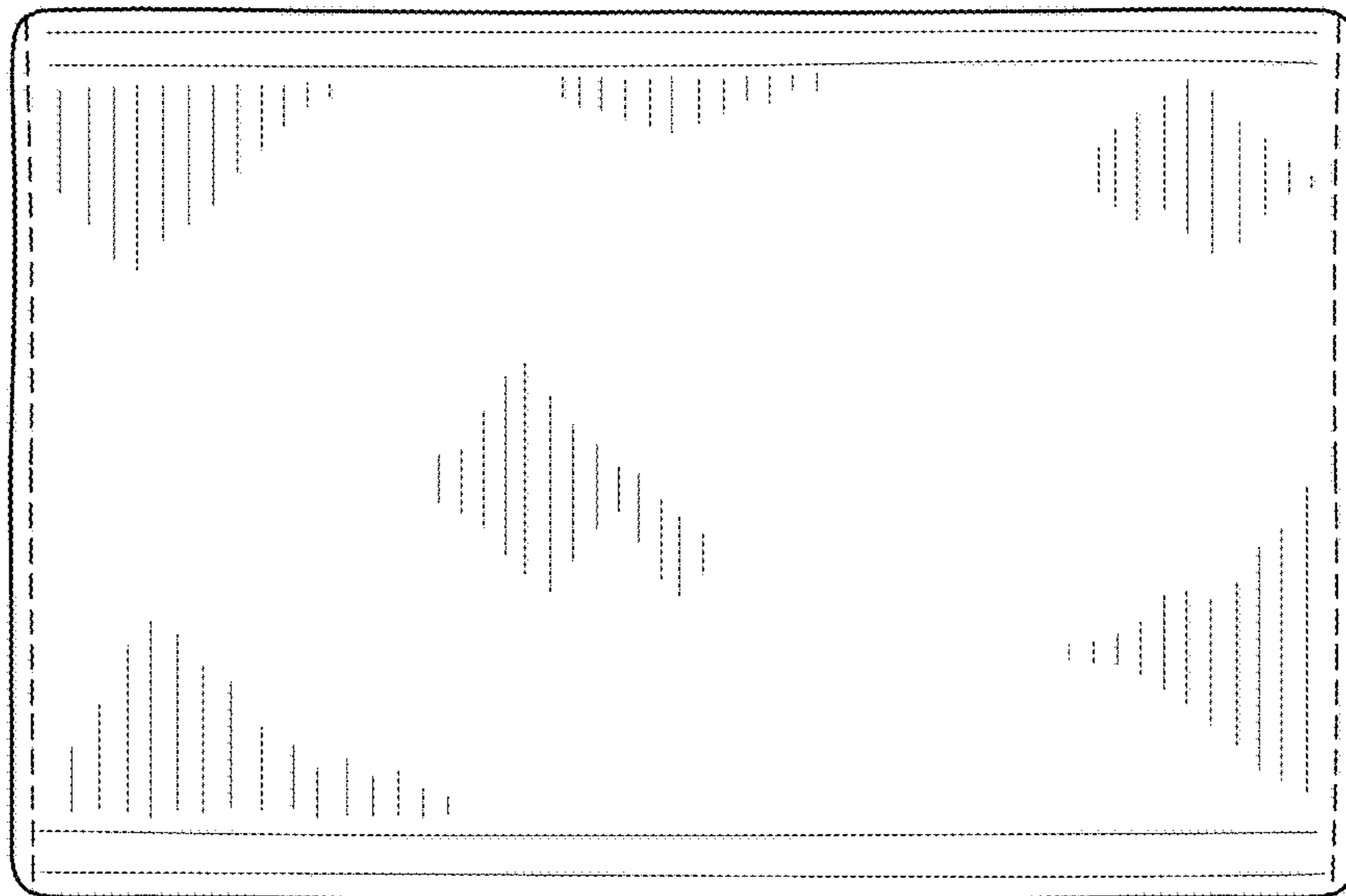


**FIG. 5**



*FIG. 6*





**FIG. 7**

