



US00D845643S

(12) **United States Design Patent**
Gunjian

(10) **Patent No.:** **US D845,643 S**

(45) **Date of Patent:** **** Apr. 16, 2019**

(54) **GRILL BRUSH**

(71) Applicant: **Brushtech, Inc.**, Plattsburgh, NY (US)

(72) Inventor: **Zaven Gunjian**, Plattsburgh, NY (US)

(73) Assignee: **Brushtech, Inc.**, Plattsburgh, NY (US)

(**) Term: **15 Years**

(21) Appl. No.: **29/634,393**

(22) Filed: **Jan. 22, 2018**

(51) **LOC (11) Cl.** **04-01**

(52) **U.S. Cl.**

USPC **D4/131**

(58) **Field of Classification Search**

USPC D4/119, 129, 131, 132, 138; D7/393,
D7/395, 401.2; D8/107; D32/51, 52;
15/27, 106, 143.1, 159.1, 160, 164, 206
CPC A46B 3/00; A46B 3/18; A46B 5/0004;
A46B 5/0012; A46B 5/02; A46B 5/021;
A46B 2200/00; A46B 2200/30; A46B
2200/3006; A46B 2200/3033; A46B
2200/304; A46B 2200/3093

See application file for complete search history.

(56) **References Cited**

U.S. PATENT DOCUMENTS

D601,347 S * 10/2009 Wales D4/122
D664,771 S * 8/2012 Gunjian D4/131
D665,178 S * 8/2012 Zemel D4/131
D700,438 S * 3/2014 Borovicka D4/131
D714,557 S * 10/2014 Gonzalez D4/131
D742,121 S * 11/2015 Borovicka D4/119

D789,095 S * 6/2017 Wales D4/131
D814,803 S * 4/2018 Zemel D4/131
D816,347 S * 5/2018 Zemel D4/131
D819,977 S * 6/2018 Zemel D4/131

* cited by examiner

Primary Examiner — Austin Murphy

(74) *Attorney, Agent, or Firm* — Burr & Brown, PLLC

(57) **CLAIM**

The ornamental design for a grill brush, as shown and described.

DESCRIPTION

FIG. 1 is a bottom perspective view of a grill brush illustrating my new design;
FIG. 2 is a front view thereof;
FIG. 3 is a right side view thereof;
FIG. 4 is a left side view thereof;
FIG. 5 is a bottom view thereof;
FIG. 6 is a top view thereof;
FIG. 7 is a bottom perspective view of a grill brush illustrating my new design;
FIG. 8 is a front view thereof;
FIG. 9 is a right side view thereof;
FIG. 10 is a left side view thereof;
FIG. 11 is a bottom view thereof; and,
FIG. 12 is a top view thereof.

The broken lines in the drawings depict unclaimed subject matter only and form no part of the claimed design.

1 Claim, 8 Drawing Sheets

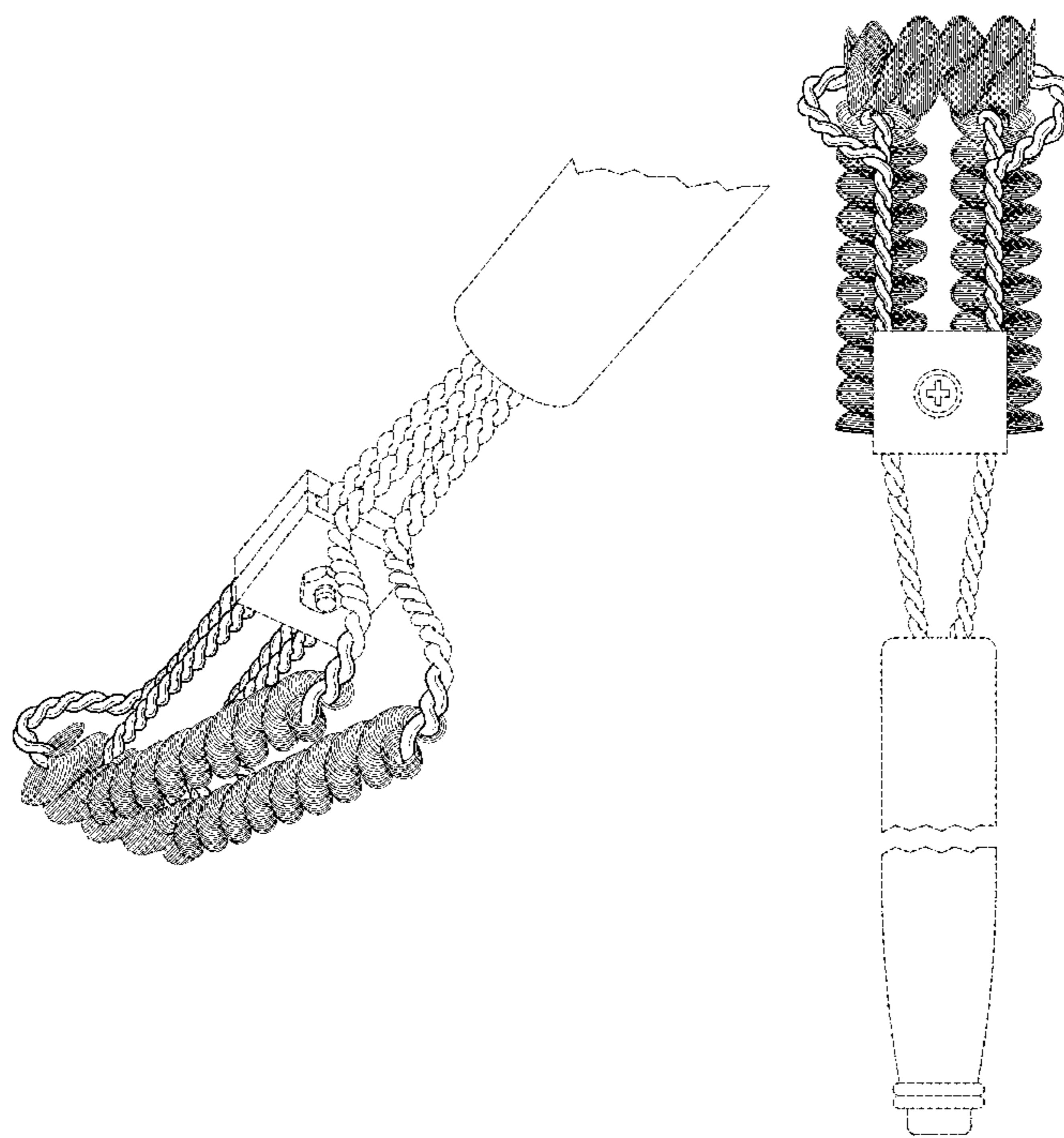

FIG. 1

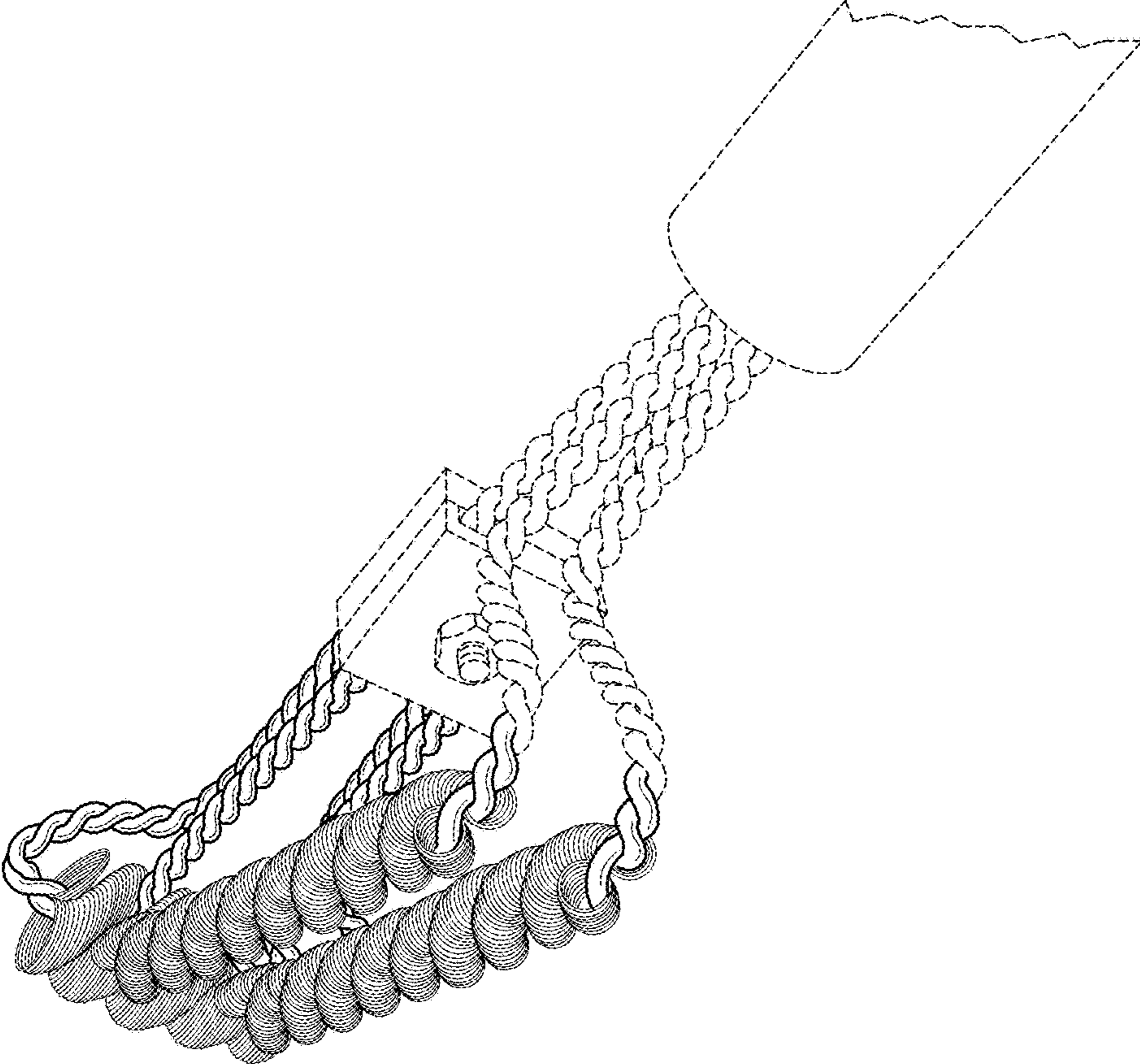

FIG. 2

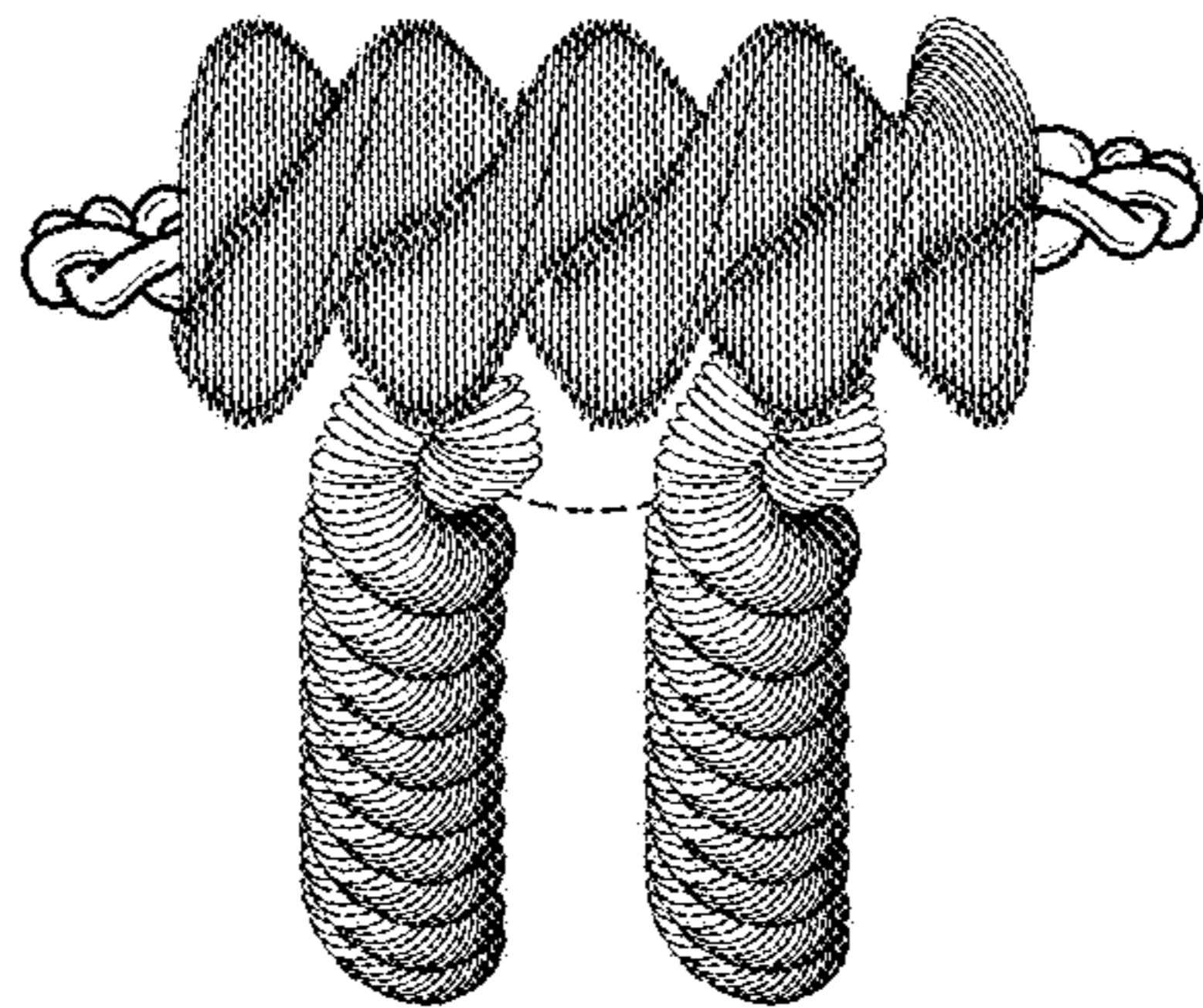

FIG. 3

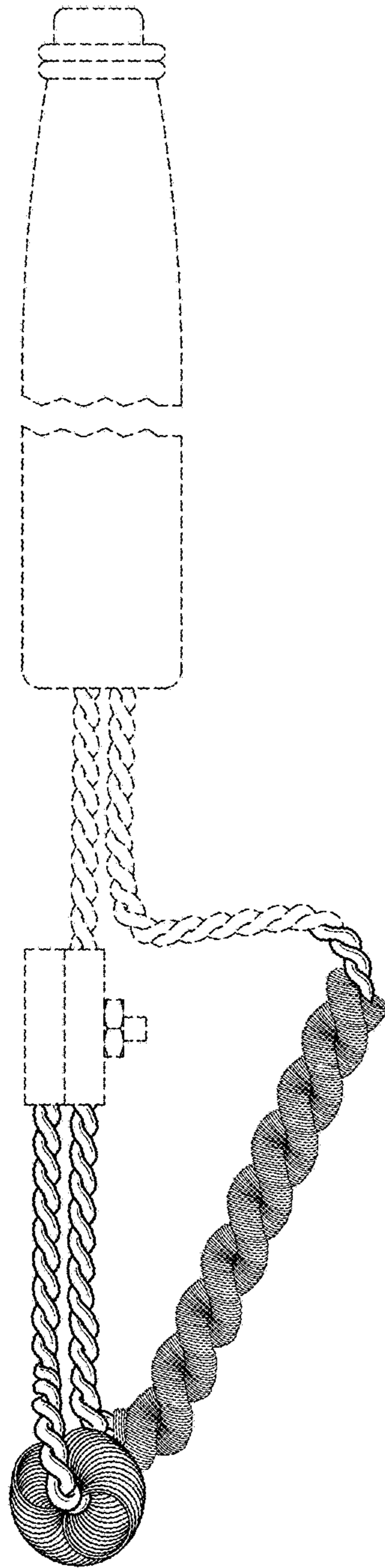

FIG. 4

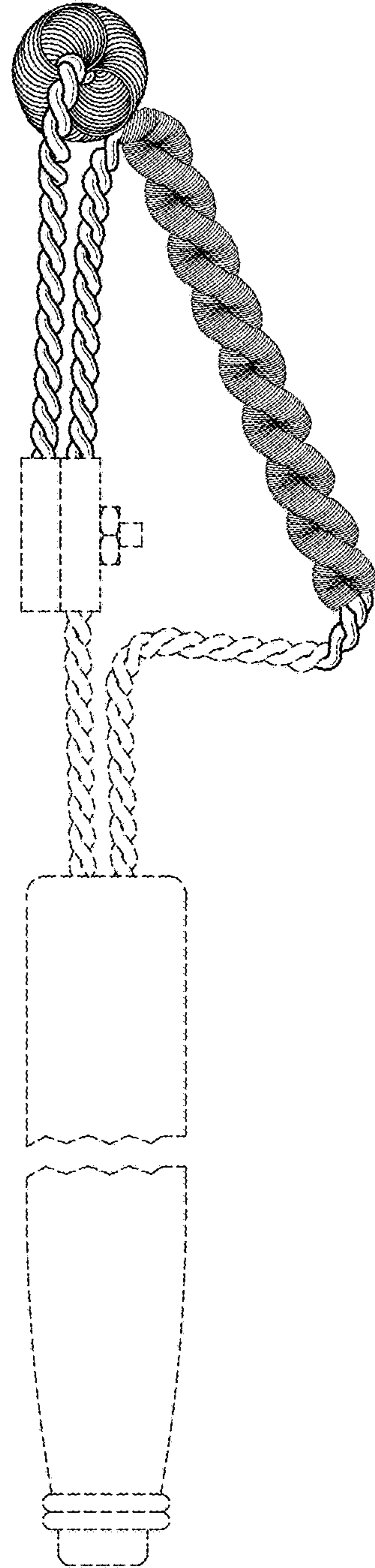

FIG. 5

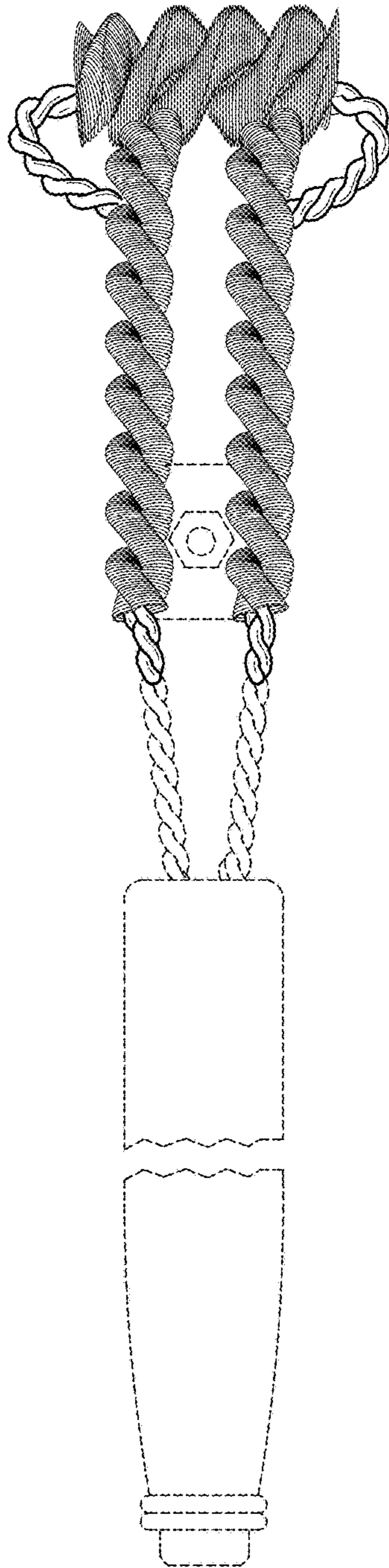

FIG. 6

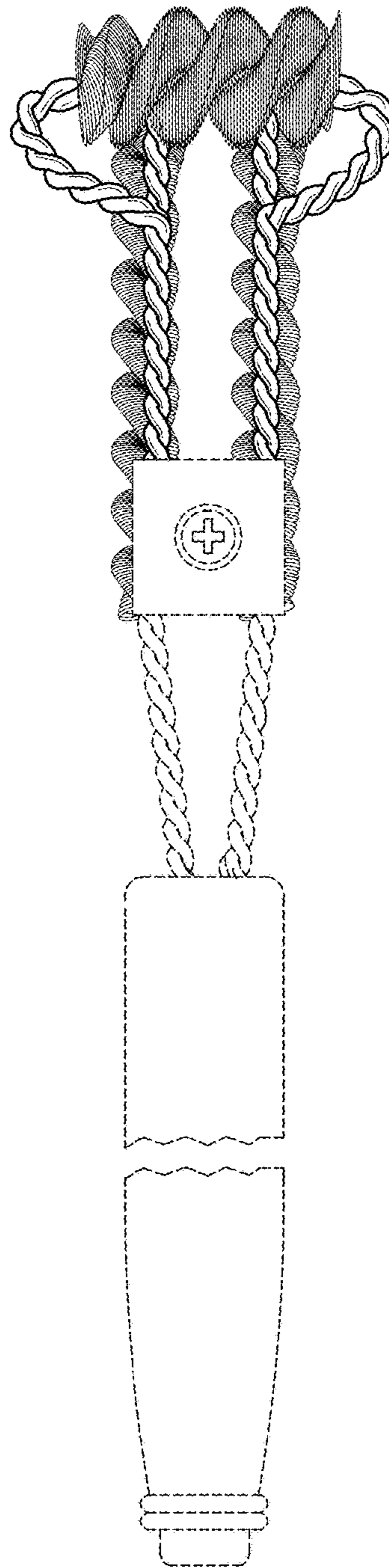

FIG. 7

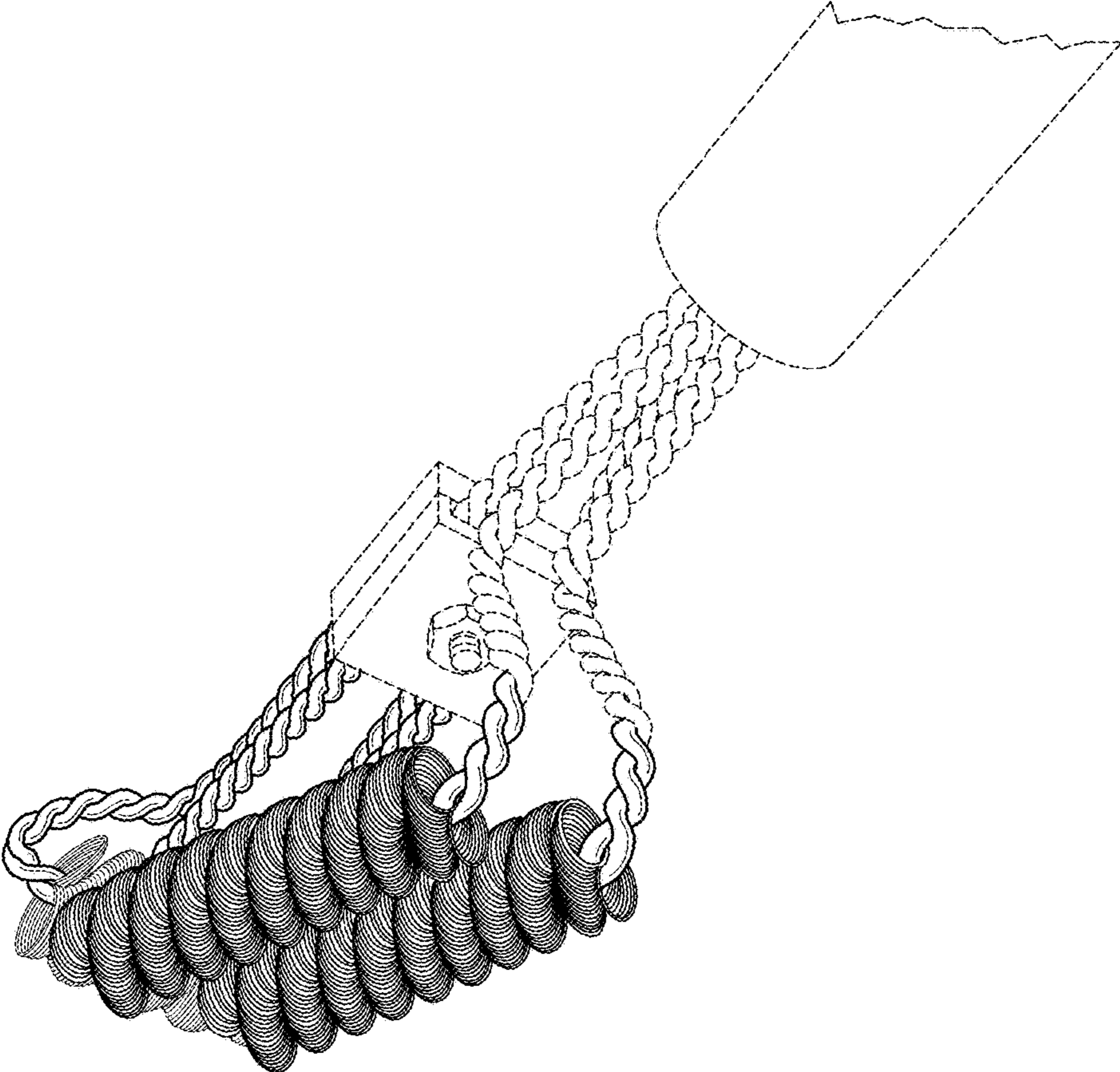

FIG. 8

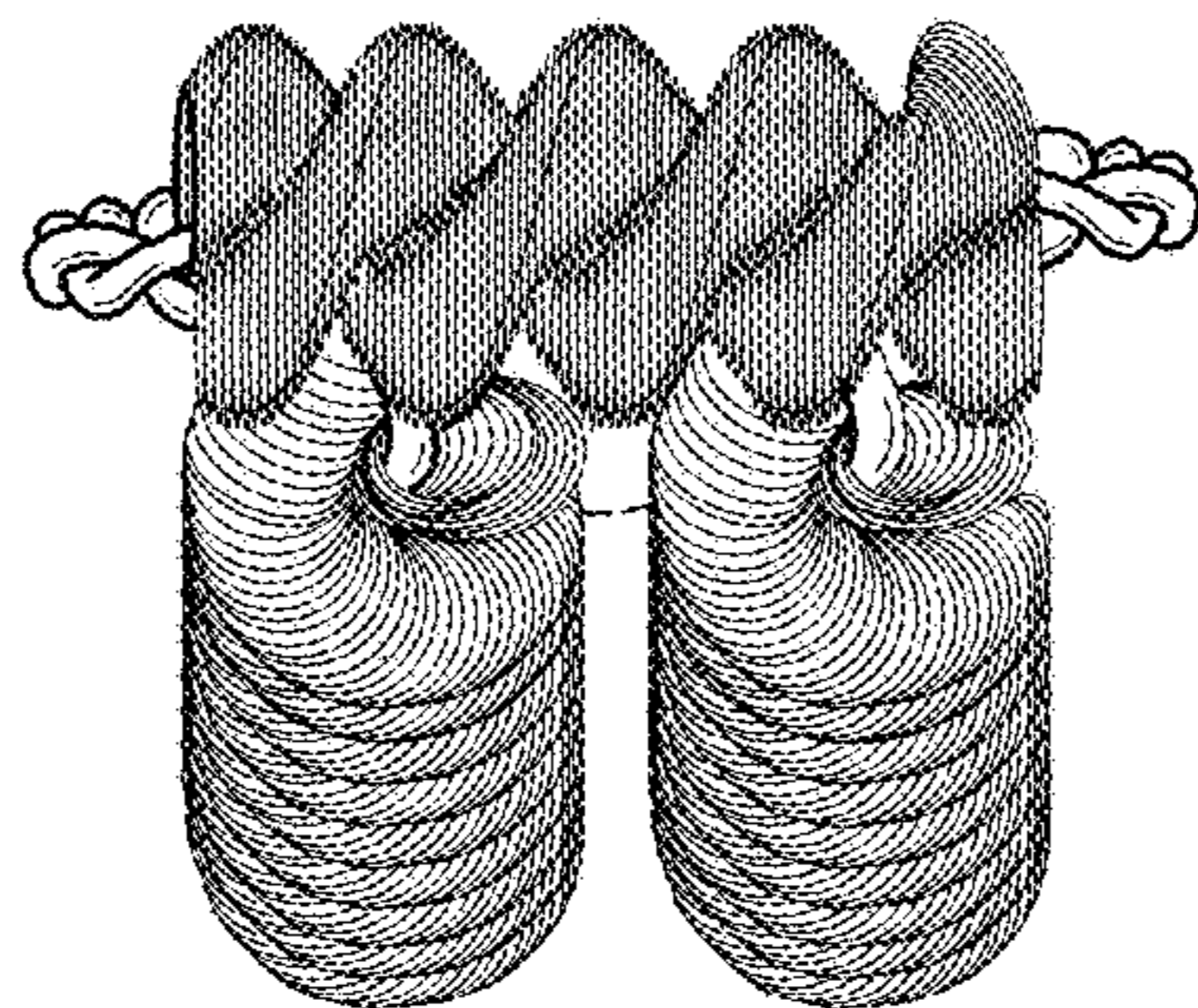

FIG. 9

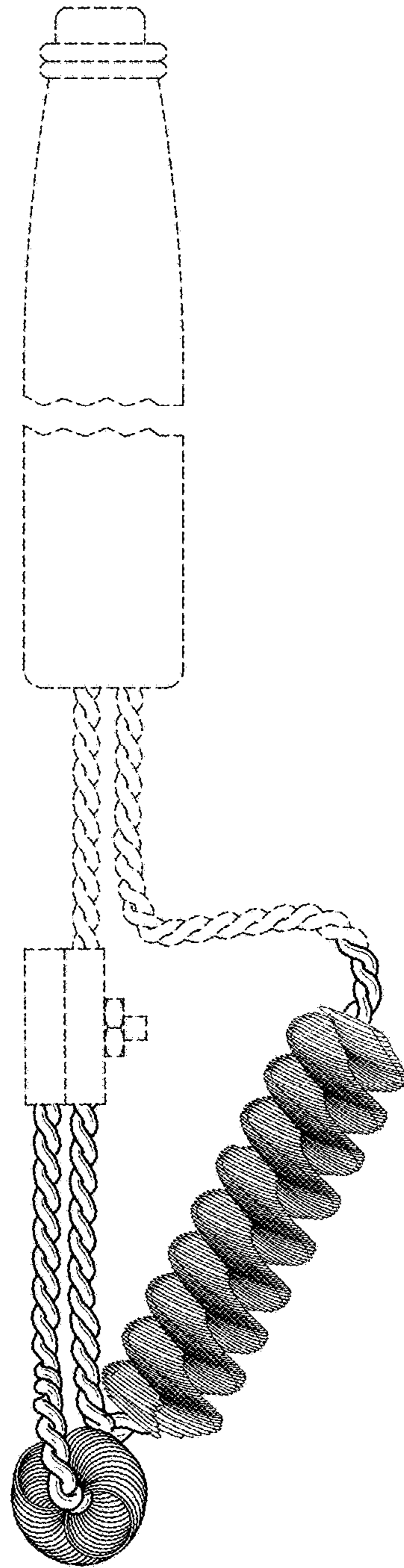

FIG. 10

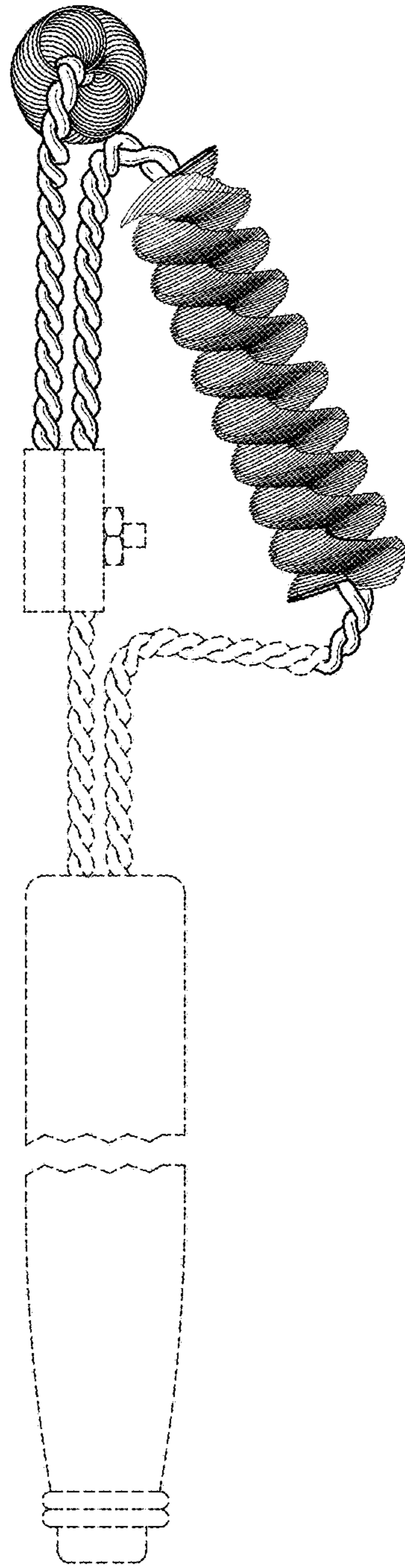

FIG. 11

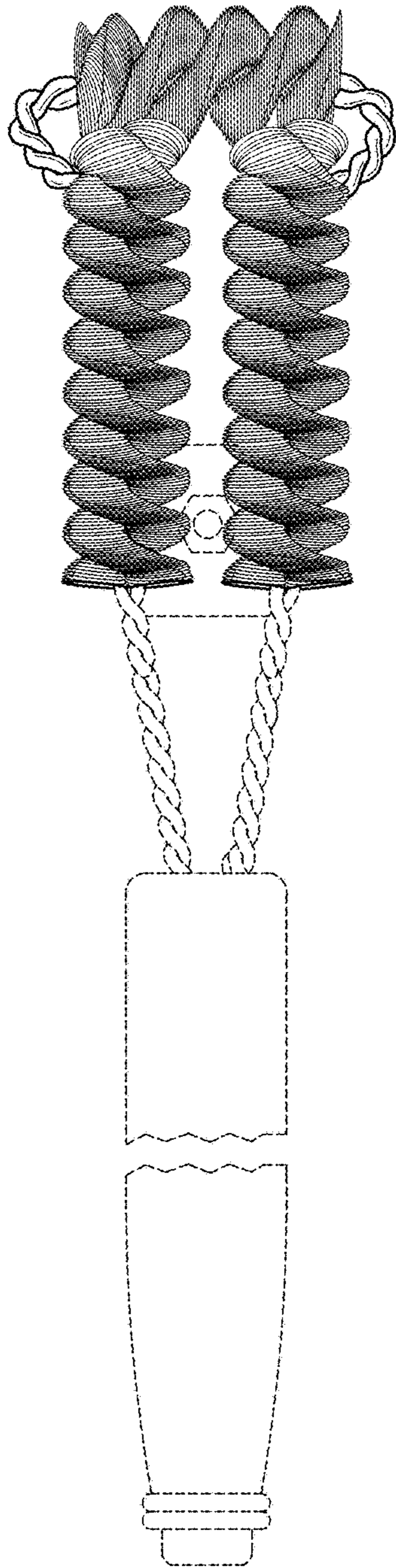

FIG. 12

