



US00D845598S

(12) **United States Design Patent**  
**Loveder et al.**

(10) **Patent No.:** **US D845,598 S**

(45) **Date of Patent:** **\*\* Apr. 16, 2019**

(54) **FOOTWEAR SOLE**

(71) Applicant: **Wolverine Outdoors, Inc.**, Rockford, MI (US)

(72) Inventors: **Chris J. Loveder**, Rockford, MI (US);  
**Amanda Marie Hargraves**, Grand Rapids, MI (US); **Mary L. Schoenborn**, Rockford, MI (US)

(73) Assignee: **Wolverine Outdoors, Inc.**, Rockford, MI (US)

(\*\*) Term: **15 Years**

(21) Appl. No.: **29/623,921**

(22) Filed: **Oct. 27, 2017**

(51) **LOC (11) Cl.** ..... **02-04**

(52) **U.S. Cl.**  
USPC ..... **D2/957; D2/947; D2/951; D2/960**

(58) **Field of Classification Search**  
USPC ..... D2/902, 906, 908, 916, 918, 925, D2/946-962, 977; 36/1, 1.5, 3 B, 22 R, 36/24.5, 25 R, 28, 32 R, 34 R, 59 C, 36/67 A, 101-107, 114-116, 117.3, 117.4, 36/124-136; D12/544  
CPC ..... A43B 13/00; A43B 13/02; A43B 13/023; A43B 13/026; A43B 13/04; A43B 13/08; A43B 13/10; A43B 13/12; A43B 13/14; A43B 13/141; A43B 13/143; A43B 13/16; A43B 13/18; A43B 13/181; A43B 13/187; A43B 13/189; A43B 13/20; A43B 13/22; A43B 13/223; A43B 13/24; A43B 13/28; A43B 13/30; A43B 13/32; A43B 13/34; A43B 13/36

See application file for complete search history.

(56) **References Cited**

**U.S. PATENT DOCUMENTS**

2,364,691 A \* 12/1944 Cagney ..... A43B 13/08  
12/146 B  
2,394,704 A \* 2/1946 Loewer ..... A43B 13/08  
12/146 B

D273,246 S \* 4/1984 Tonkel ..... D2/956  
D294,537 S \* 3/1988 Le ..... D2/960  
5,216,824 A 6/1993 Bissett et al.  
D394,143 S \* 5/1998 Sink ..... D2/960

(Continued)

**OTHER PUBLICATIONS**

Men's Reuben Oxford, Wolverine.com, [online], [site visited Jan. 7, 2019]. <URL: [https://www.wolverine.com/US/en/reuben-oxford/28297M.html?dwvar\\_28297M\\_color=W40345](https://www.wolverine.com/US/en/reuben-oxford/28297M.html?dwvar_28297M_color=W40345)> (Year: 2019).\*

(Continued)

*Primary Examiner* — T Chase Nelson

*Assistant Examiner* — Jonathan J. Han

(74) *Attorney, Agent, or Firm* — Warner Norcross + Judd LLP

(57) **CLAIM**

The ornamental design for footwear sole, as shown and described.

**DESCRIPTION**

FIG. 1 is a perspective view of the footwear sole embodying the new design;

FIG. 2 is a bottom plan view thereof;

FIG. 3 is a right side elevational view thereof;

FIG. 4 is a left side elevational view thereof;

FIG. 5 is a front view thereof; and,

FIG. 6 is a rear view thereof.

FIGS. 1-6 show portions of the footwear in broken lines, which portions are not included in the claim, or which depict environment that is not included in the claim. The broken lines around the perimeter, and immediately adjacent the solid-line portion of the design, form the boundary of the claimed design, with the broken lines forming no part of the claimed design.

**1 Claim, 5 Drawing Sheets**

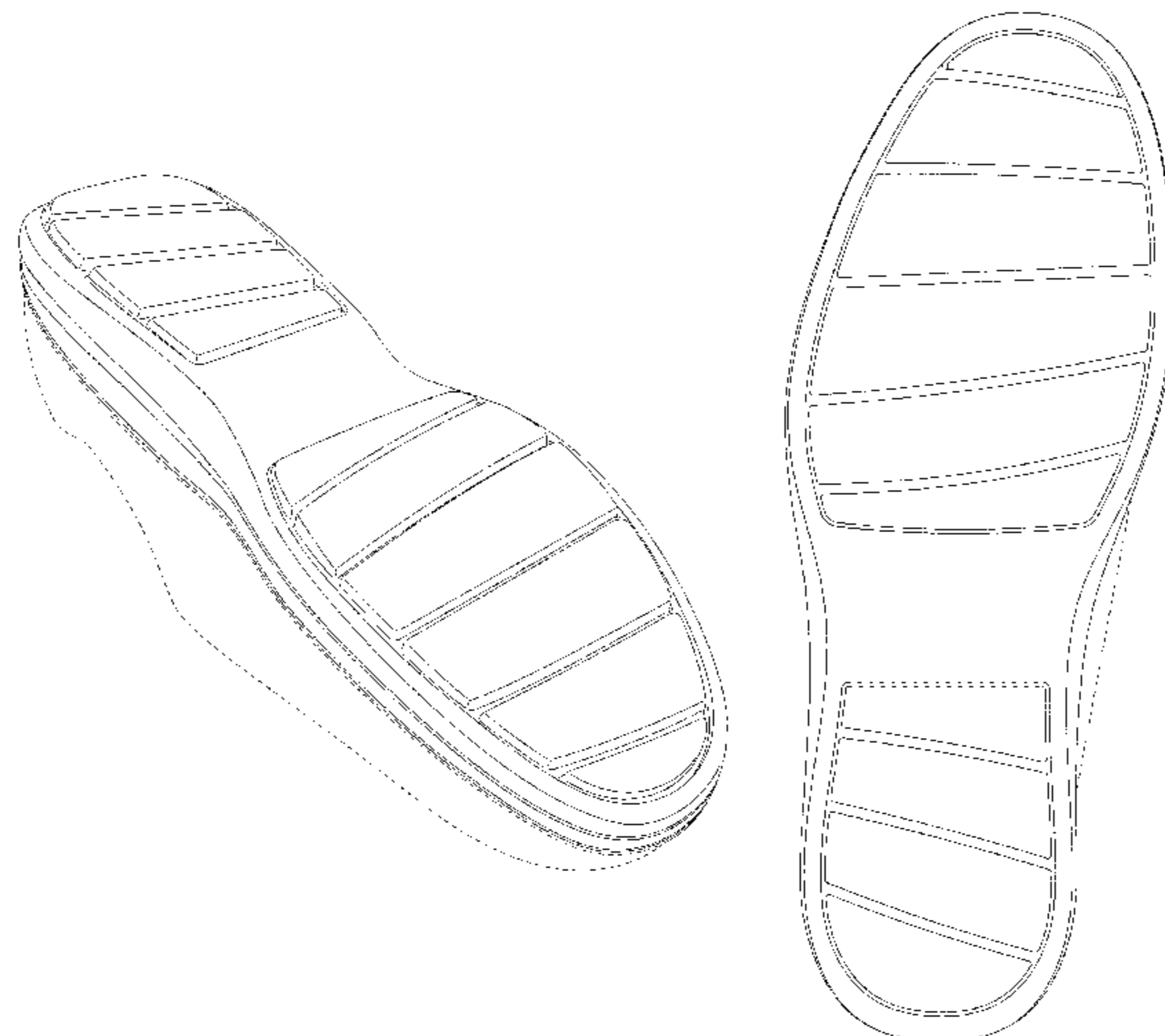

(56)

## References Cited

## U.S. PATENT DOCUMENTS

5,918,385	A	7/1999	Sessa	
7,313,875	B2	1/2008	Morgan	
D568,594	S *	5/2008	Ringholz .....	D2/957
D573,780	S *	7/2008	Davis .....	D2/951
D584,887	S *	1/2009	Earle .....	D2/951
D634,108	S *	3/2011	Tzenos .....	D2/947
D643,197	S *	8/2011	Teteriatnikov .....	D2/951
D643,606	S *	8/2011	Raysse .....	D2/951
D649,754	S *	12/2011	Callahan .....	D2/951
8,127,468	B2	3/2012	Morgan	
D730,035	S *	5/2015	Henderson .....	D2/947
D741,588	S *	10/2015	Weeks .....	D2/951
D756,096	S *	5/2016	Bizzo .....	D2/951
9,433,256	B2 *	9/2016	Callahan .....	A43B 3/0057
D778,565	S *	2/2017	Sars .....	D2/960
9,717,304	B2 *	8/2017	Bernhard .....	A43B 13/125
D800,433	S *	10/2017	Kuerbis .....	D2/957
D801,658	S *	11/2017	Huard .....	D2/960
D806,995	S *	1/2018	Tæstensen .....	D2/923
D813,503	S *	3/2018	Brunner .....	D2/908
9,999,274	B2 *	6/2018	Henderson .....	A43B 3/0057
D822,957	S *	7/2018	Brunner .....	D2/908
D822,962	S *	7/2018	Ringdal .....	D2/923
D822,966	S *	7/2018	Thompson .....	D2/953
D827,257	S *	9/2018	Ringholz .....	D2/916
D831,319	S *	10/2018	Vasyli .....	D2/960
D831,938	S *	10/2018	Ghesquiere .....	D2/902
2016/0227878	A1 *	8/2016	Lan .....	A43B 13/223

## OTHER PUBLICATIONS

Wolverine Reuben SKU:8817228, YouTube.com, Shop Zappos, Published on Mar. 28, 2017, [online], [site visited Jan. 7, 2019]. <URL: <https://www.youtube.com/watch?v=crQH2NaL9b4>> (Year: 2017).\*

Different types of soles on Men's Shoes, BigFootShoes.co.uk, by bigfootadmin, [online], [site visited Jan. 7, 2019]. <URL: <http://bigfootshoes.co.uk/blog/different-types-of-soles-on-mens-shoes/>> (Year: 2019).\*

Cole Haan Men's Lunargrand Oxford, Amazon.com, Date first listed on Amazon: Oct. 12, 2012, [online], [site visited Jan. 7, 2019]. <URL: <https://www.amazon.com/Cole-Haan-Lunargrand-Wingtip-Oxford/dp/B00HK8HJJ0>> (Year: 2012).\*

Mens PVC Shoe Sole, TradeIndia.com, [online], [site visited Jan. 7, 2019]. <URL: <https://srpolyplast.tradeindia.com/mens-pvc-shoe-sole-4116845.html>> (Year: 2019).\*

Hush Puppies Bilal Patterson, [http://www.hushpuppies.com/US/en/bilal-patterson/883799677208.html?CID=MAR-Hush-Puppies-G-Shopping-Bilal-Patterson&CAWELAID=120144290000316810&CAGSPN=pla&CAAGID=36835366242&CATCI=aud-263048239173tpla-60512637292&gclid=EAlalQobChMI1PHbpe3\\_lgIVBAaGCh2-IQX4EAQYAiABEgLQj\\_D\\_BwE](http://www.hushpuppies.com/US/en/bilal-patterson/883799677208.html?CID=MAR-Hush-Puppies-G-Shopping-Bilal-Patterson&CAWELAID=120144290000316810&CAGSPN=pla&CAAGID=36835366242&CATCI=aud-263048239173tpla-60512637292&gclid=EAlalQobChMI1PHbpe3_lgIVBAaGCh2-IQX4EAQYAiABEgLQj_D_BwE) (downloaded Oct. 23, 2017).

Hush Puppies Power Walker, <https://www.6pm.com/p/hush-puppies-power-walker-ii/product/7441183> (downloaded Oct. 23, 2017).

Hush Puppies Roland Jester, <https://www.6pm.com/p/hush-puppies-roland-jester/product/8647219> (downloaded Oct. 23, 2017).

\* cited by examiner

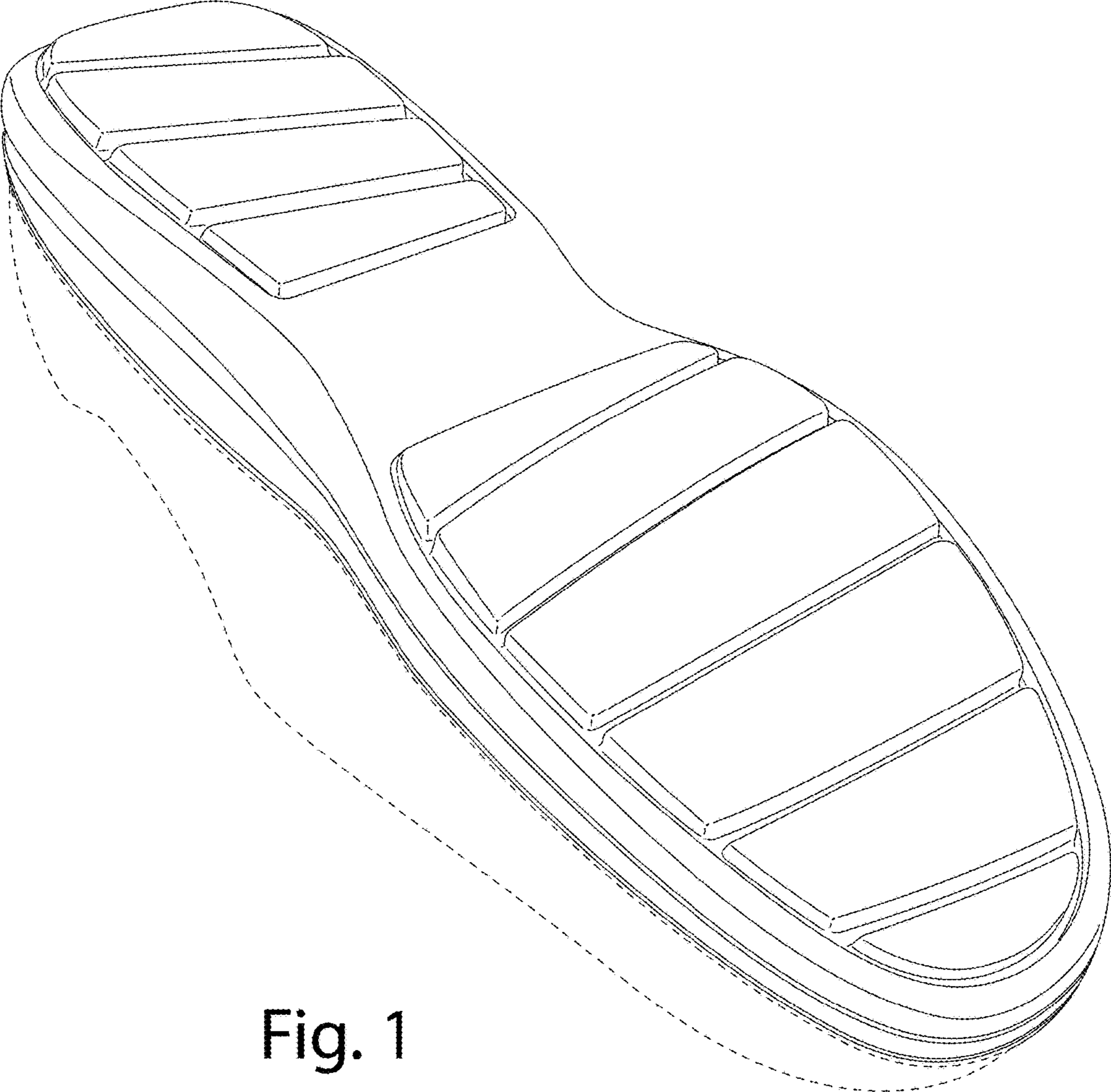

Fig. 1



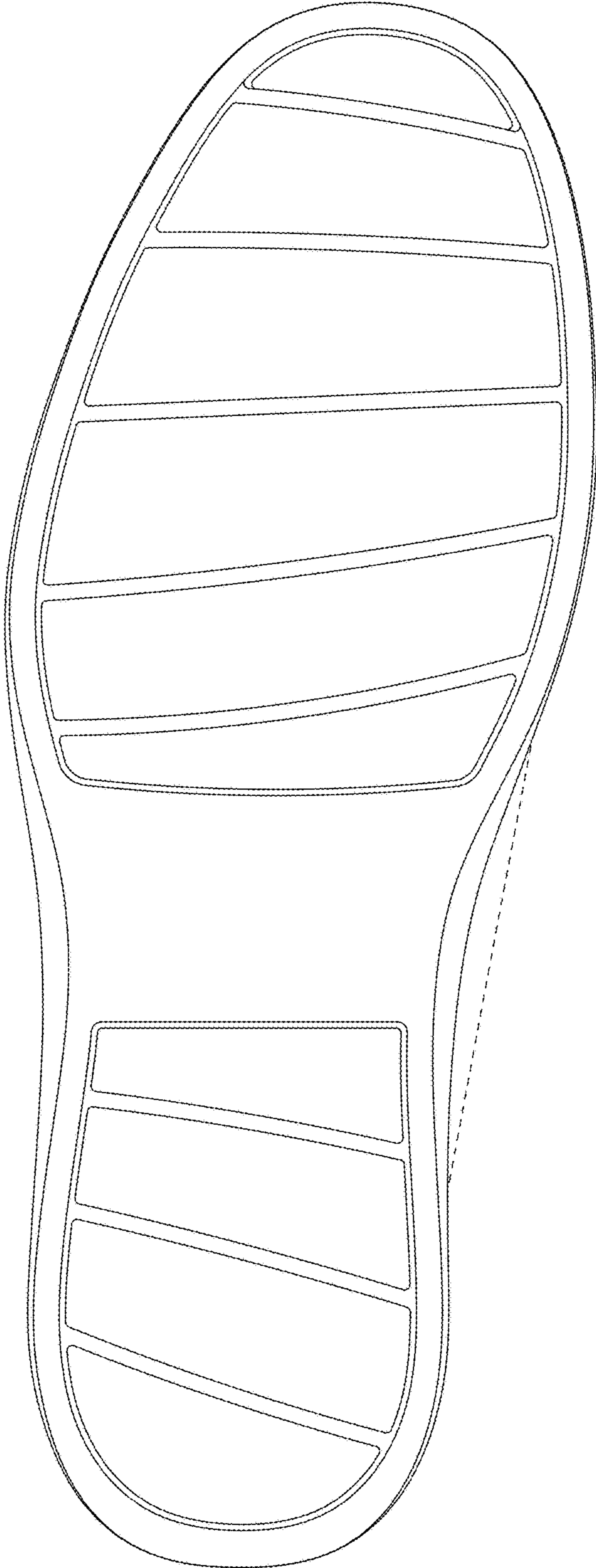

Fig. 2

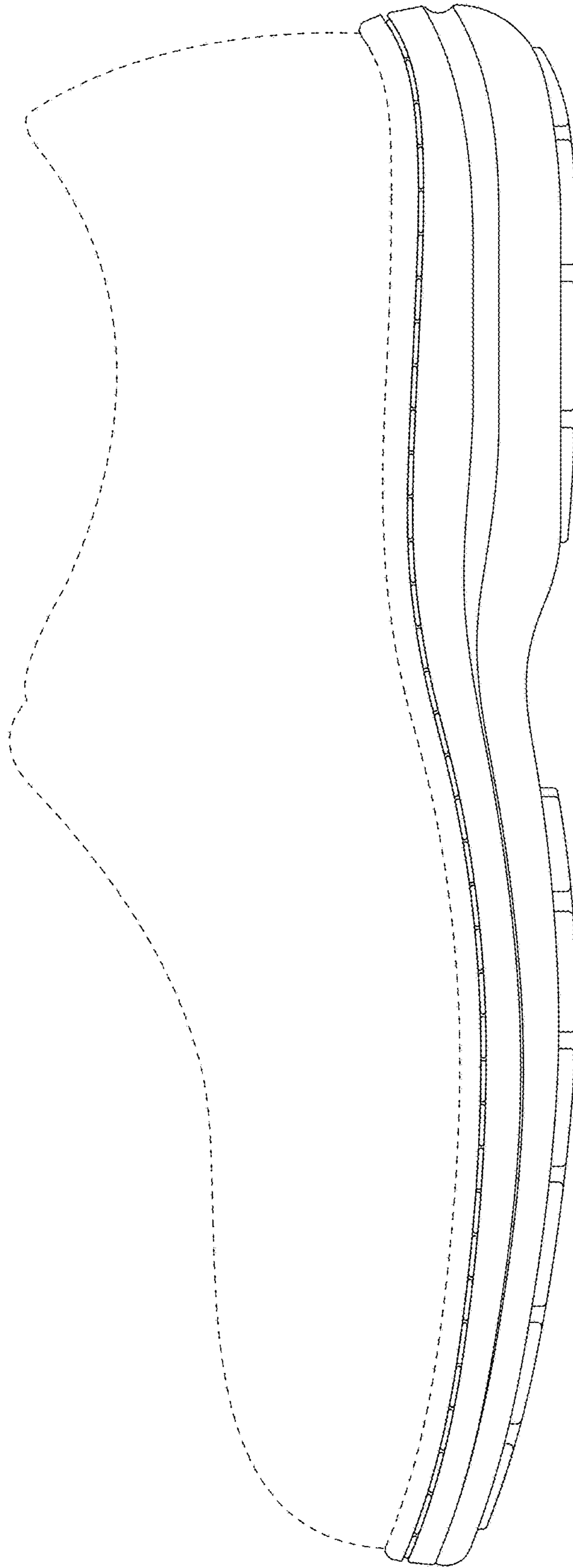

Fig. 3

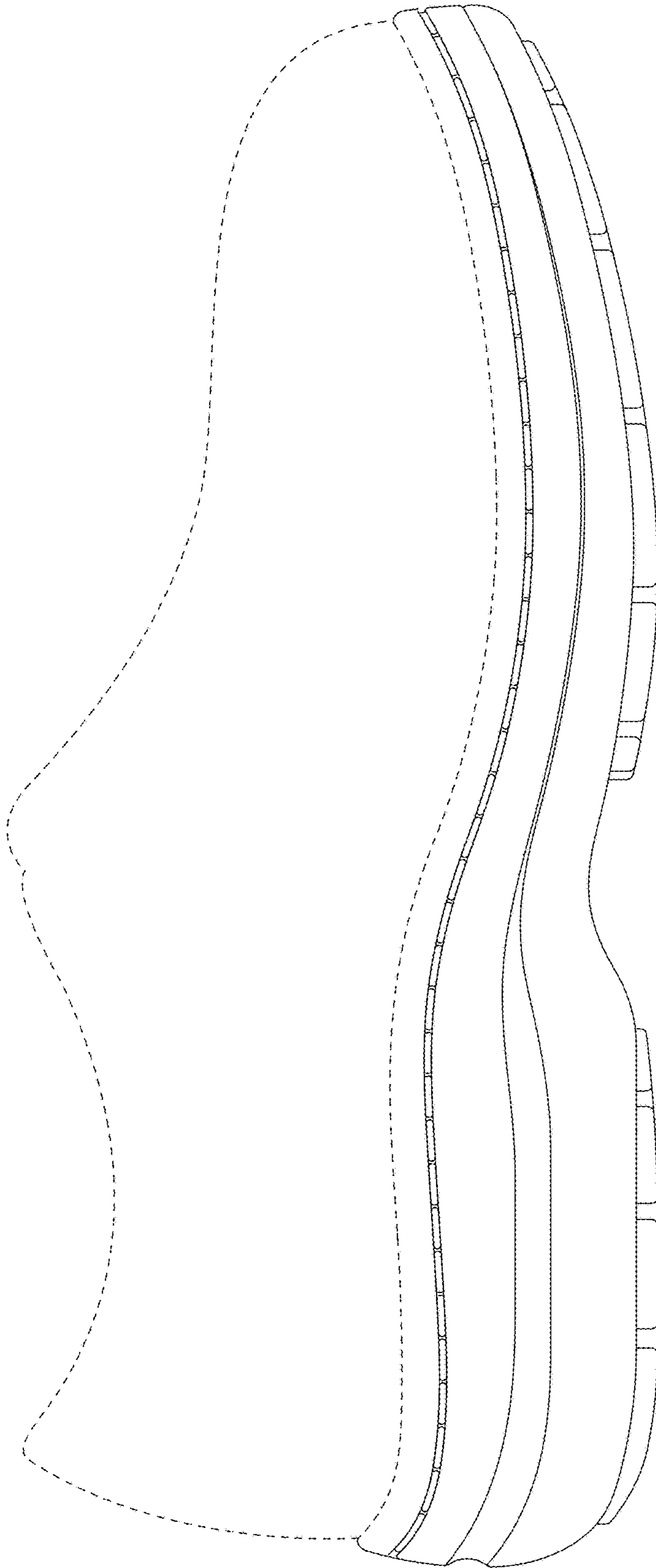

Fig. 4

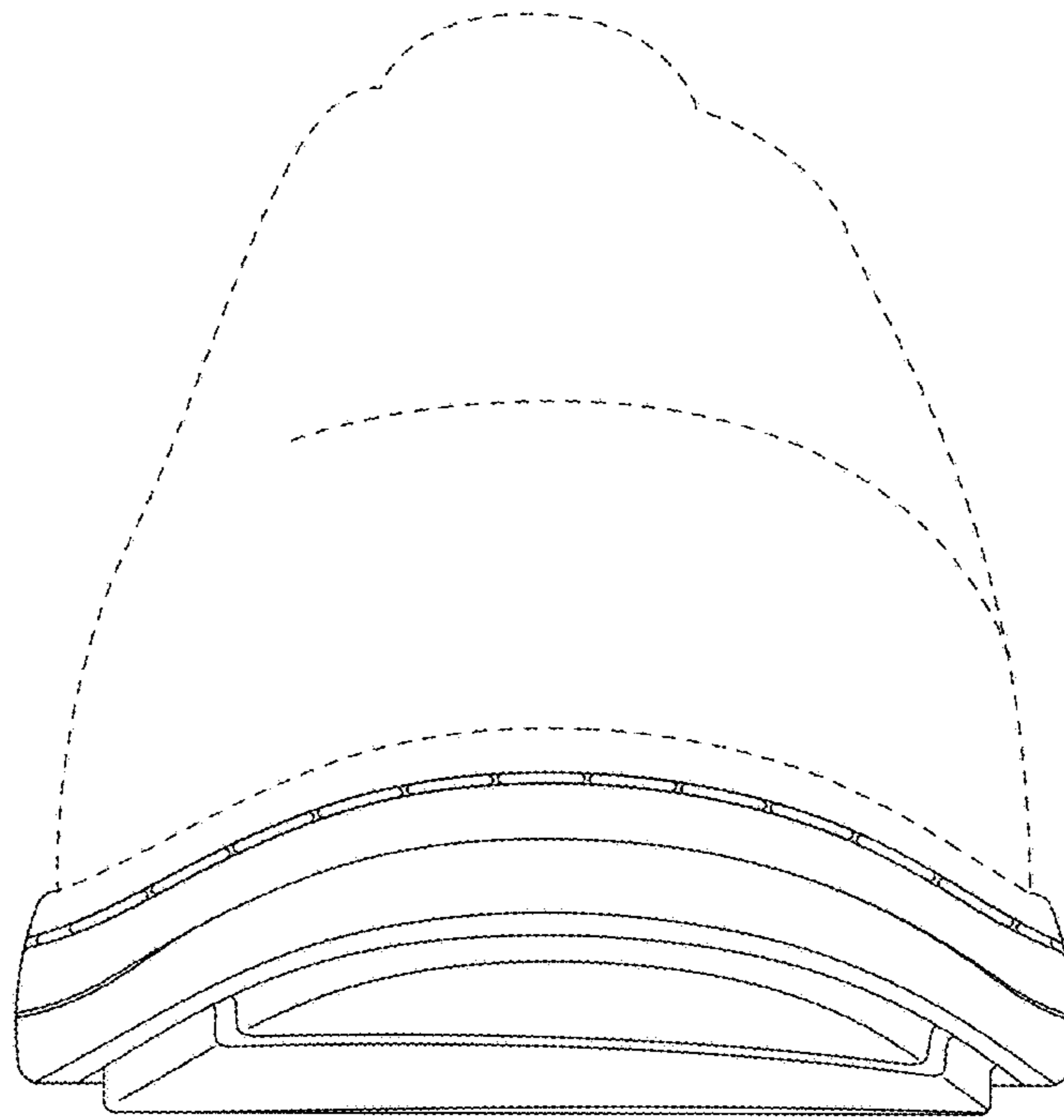

Fig. 5

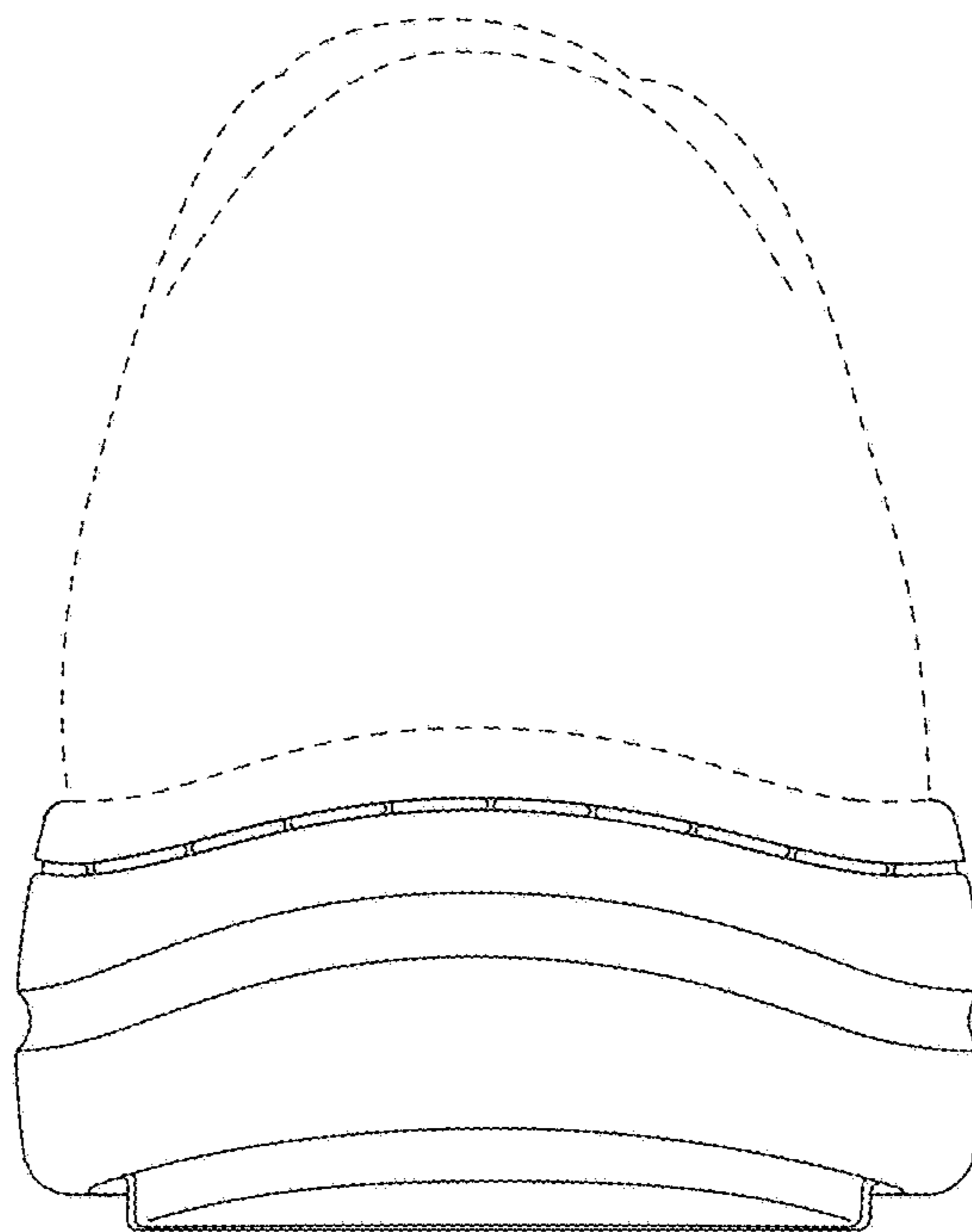

Fig. 6