



US00D845572S

(12) **United States Design Patent**
Pollard

(10) **Patent No.:** **US D845,572 S**

(45) **Date of Patent:** **** Apr. 9, 2019**

- (54) **PAINTBRUSH HOLDER**
- (71) Applicant: **Timothy Pollard**, Penrose, CO (US)
- (72) Inventor: **Timothy Pollard**, Penrose, CO (US)
- (**) Term: **15 Years**
- (21) Appl. No.: **29/669,959**
- (22) Filed: **Nov. 13, 2018**
- (51) **LOC (11) Cl.** **07-07**
- (52) **U.S. Cl.**
USPC **D32/54**
- (58) **Field of Classification Search**
USPC D32/53, 53.1, 54
CPC B44D 3/12; B44D 3/123; B44D 3/125;
B44D 3/126; B44D 3/128; A47B 17/00;
A47B 17/02; A47L 13/50; A47J 47/18;
A47G 29/08
See application file for complete search history.

- 6,237,802 B1 * 5/2001 Douglas B44D 3/123
220/736
- 6,446,829 B1 9/2002 Malvasio
- D473,689 S 4/2003 Verhaar
- 6,929,225 B1 8/2005 Kent
- D586,969 S 2/2009 Graham
- D743,137 S * 11/2015 Vasilakes D32/53
- D772,513 S * 11/2016 Milford D32/54

* cited by examiner

Primary Examiner — Robin V Webster

(57) **CLAIM**

I claim the ornamental design for a paintbrush holder, as shown and described.

DESCRIPTION

FIG. 1 is a front view of the paintbrush holder.
 FIG. 2 is a rear view of the claimed design.
 FIG. 3 is a left side view of the claimed design.
 FIG. 4 is a right side view of the claimed design.
 FIG. 5 is a top view of the claimed design.
 FIG. 6 is a bottom view of the claimed design; and,
 FIG. 7 is a perspective view of the claimed design as appears on a paint can.
 The broken lines appearing on FIG. 7 of a paint can and paintbrush are environmental matter forming no part of the claimed design.

- (56) **References Cited**
U.S. PATENT DOCUMENTS
- 1,851,521 A * 3/1932 Olsen B44D 3/125
206/361
- 1,938,376 A * 12/1933 Dietrichs B44D 3/125
206/361
- D300,970 S * 5/1989 Walker B44D 3/125
D32/53
- 5,076,519 A 12/1991 Panovic
- 5,322,183 A 6/1994 Strachan

1 Claim, 3 Drawing Sheets

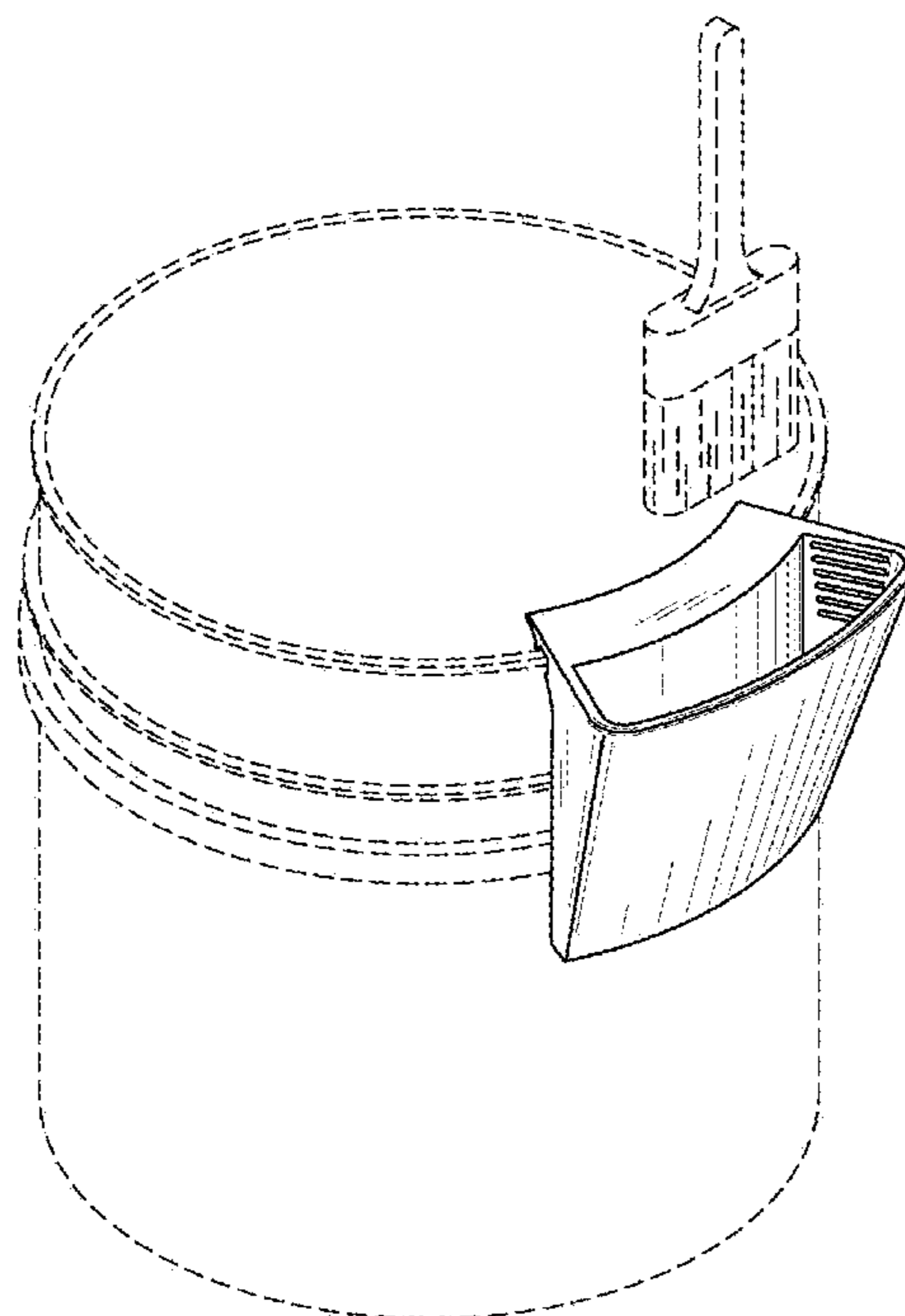

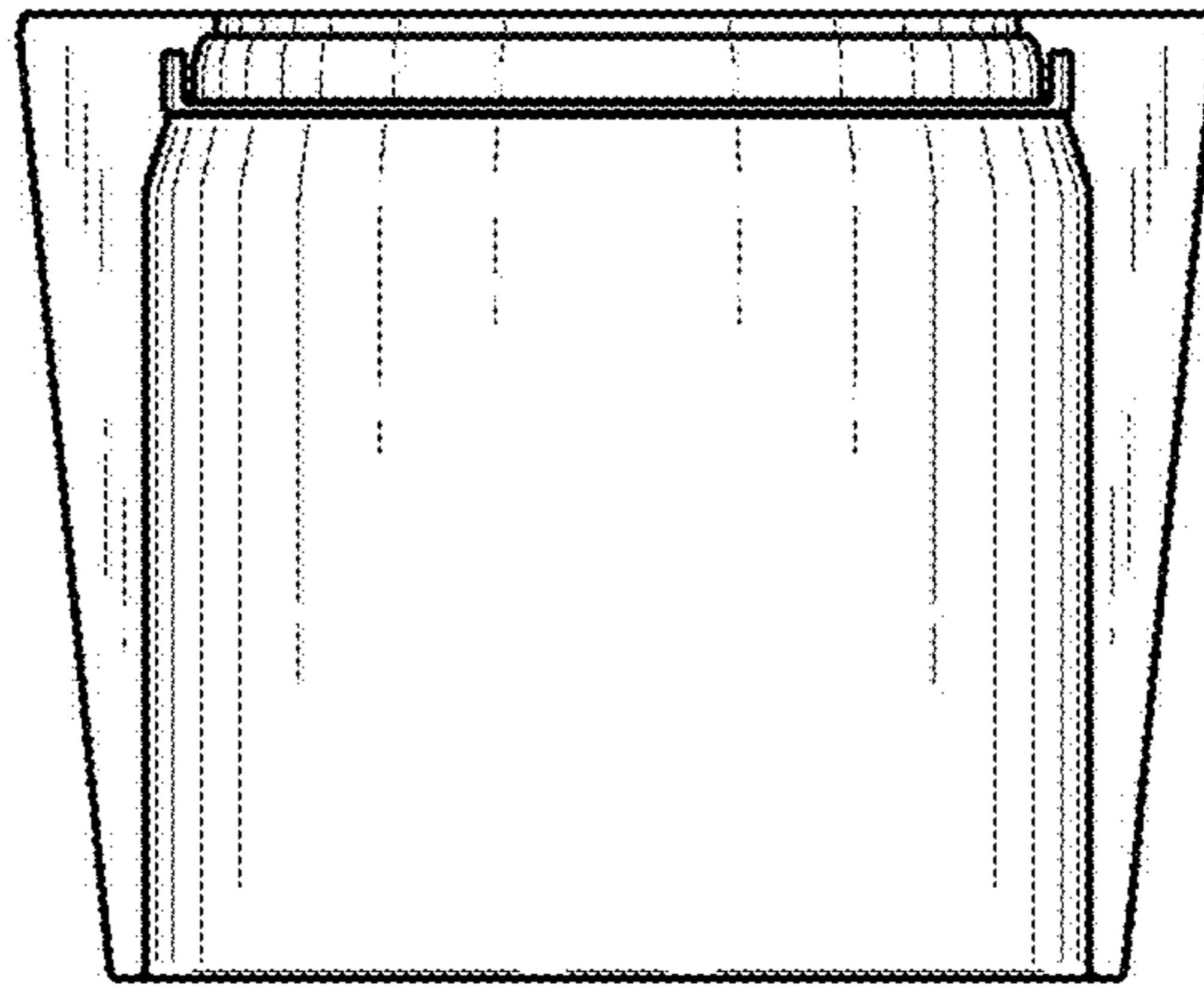

FIG. 1

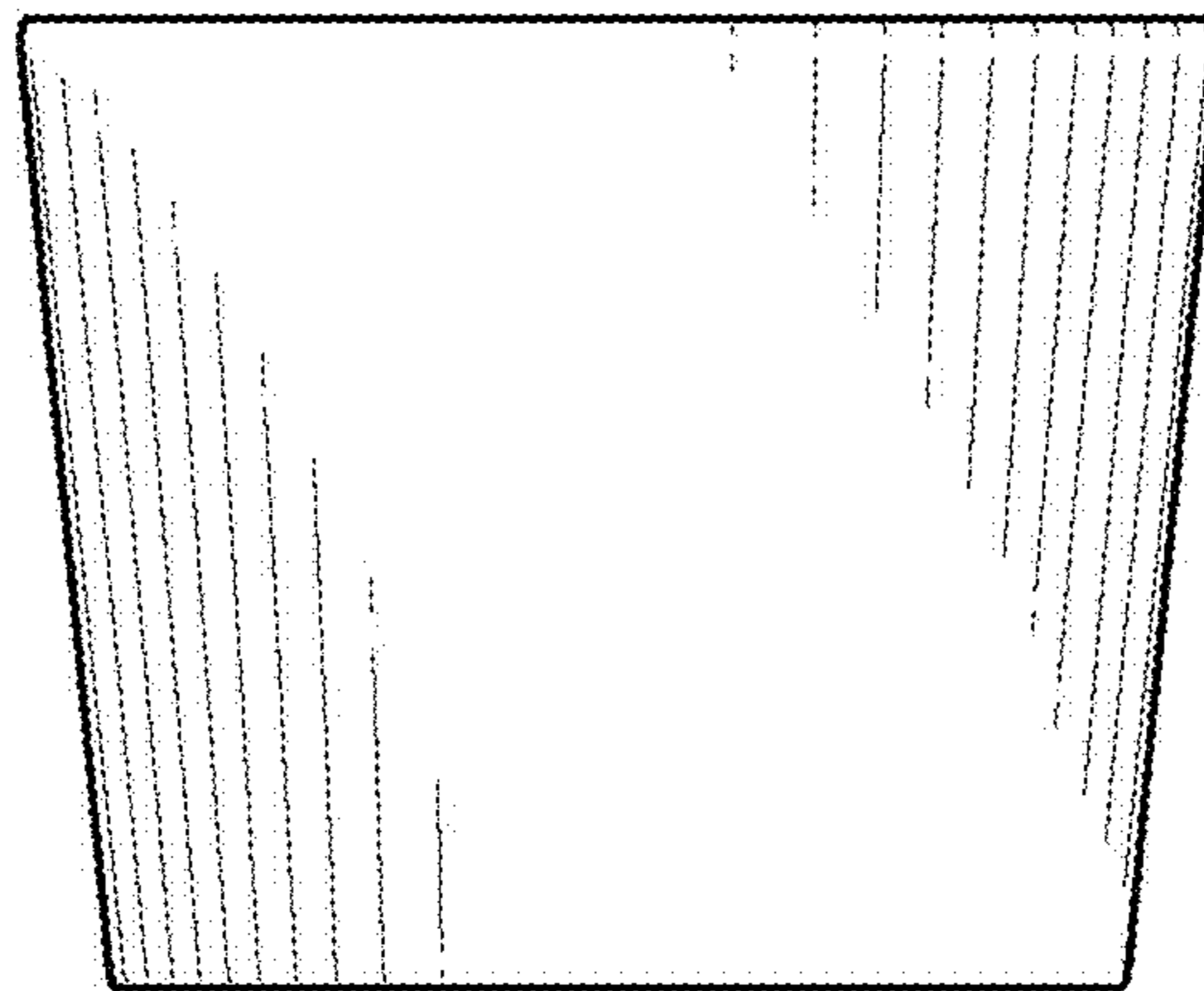

FIG. 2

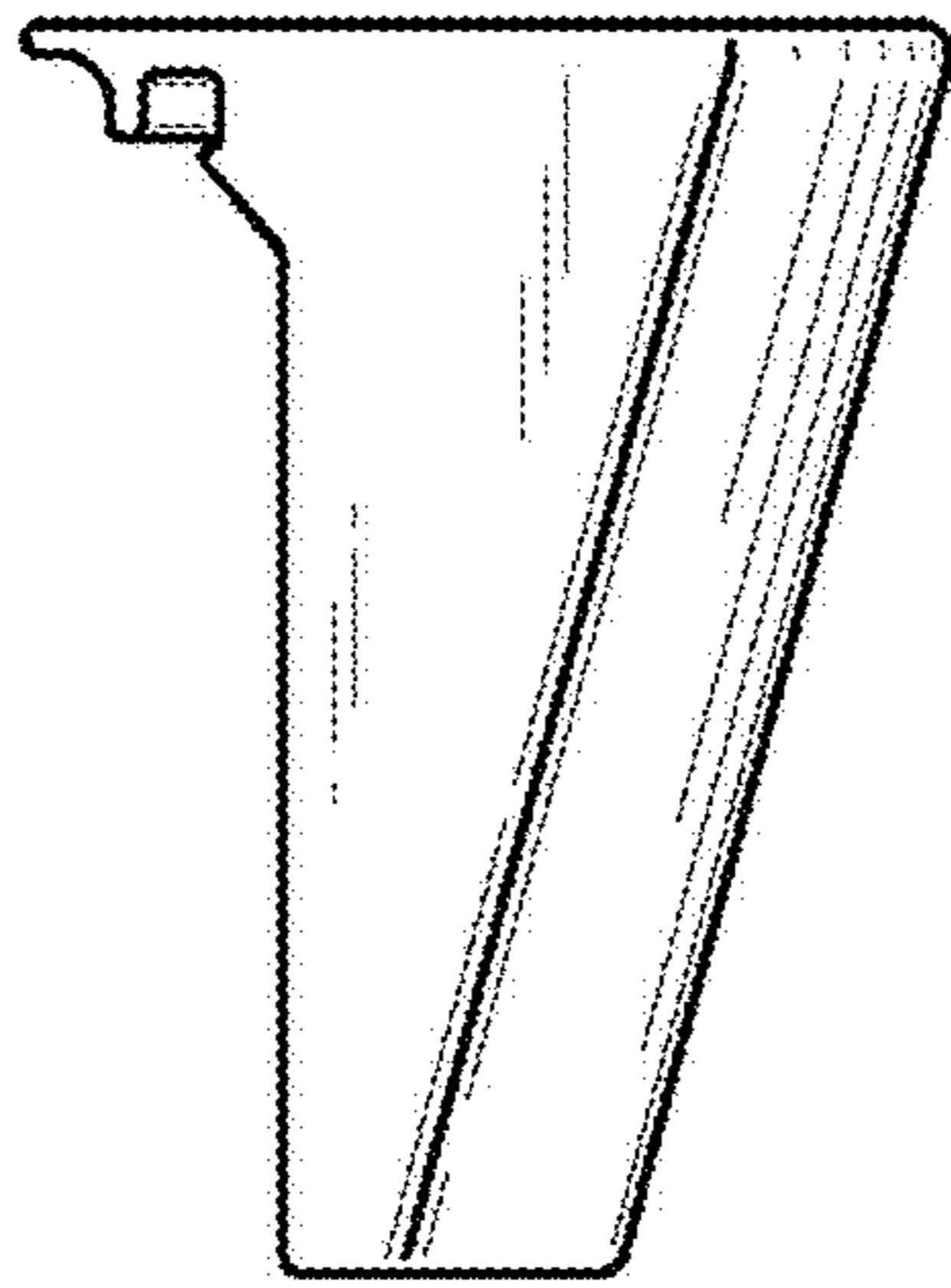

FIG. 3

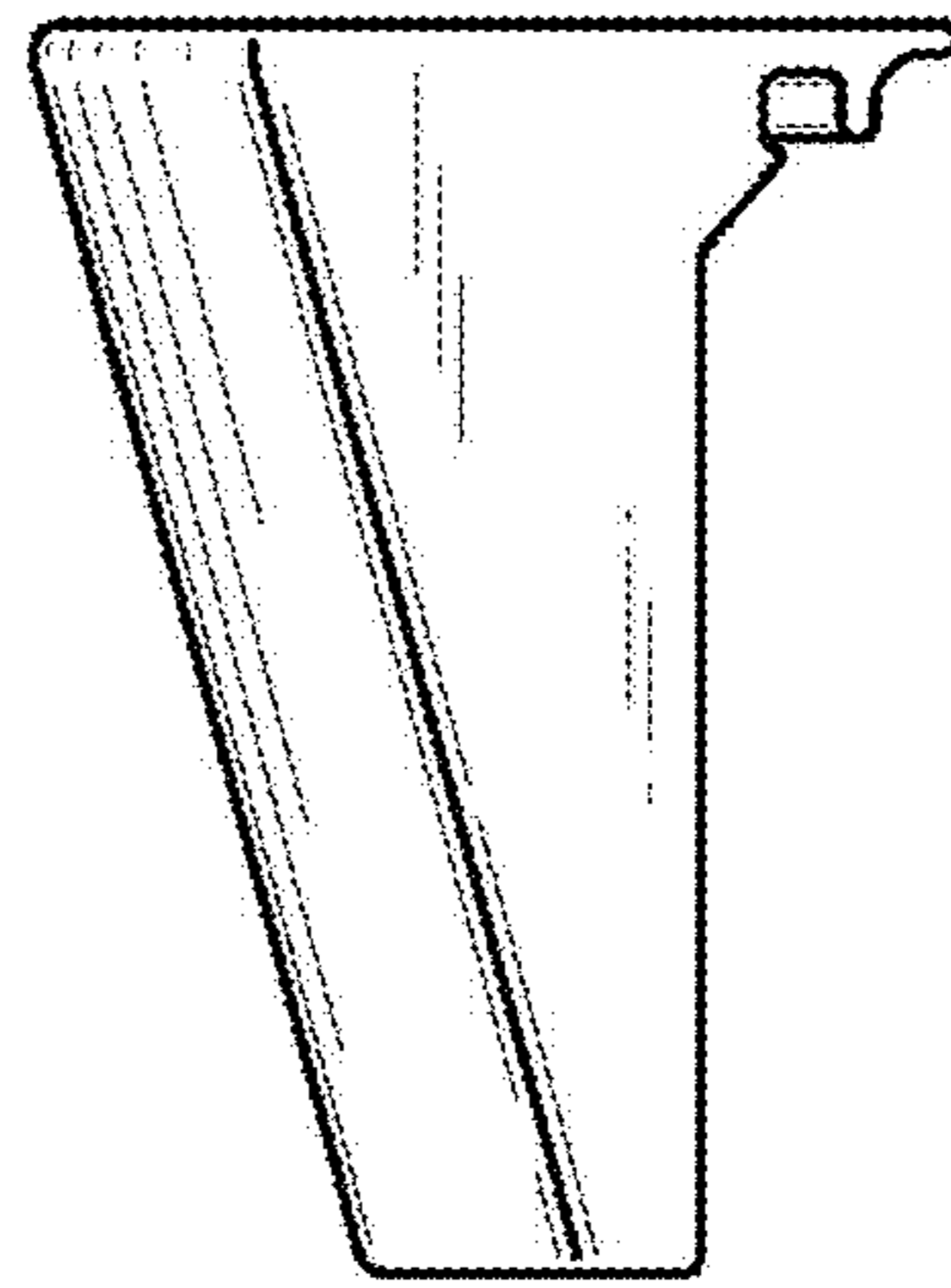

FIG. 4

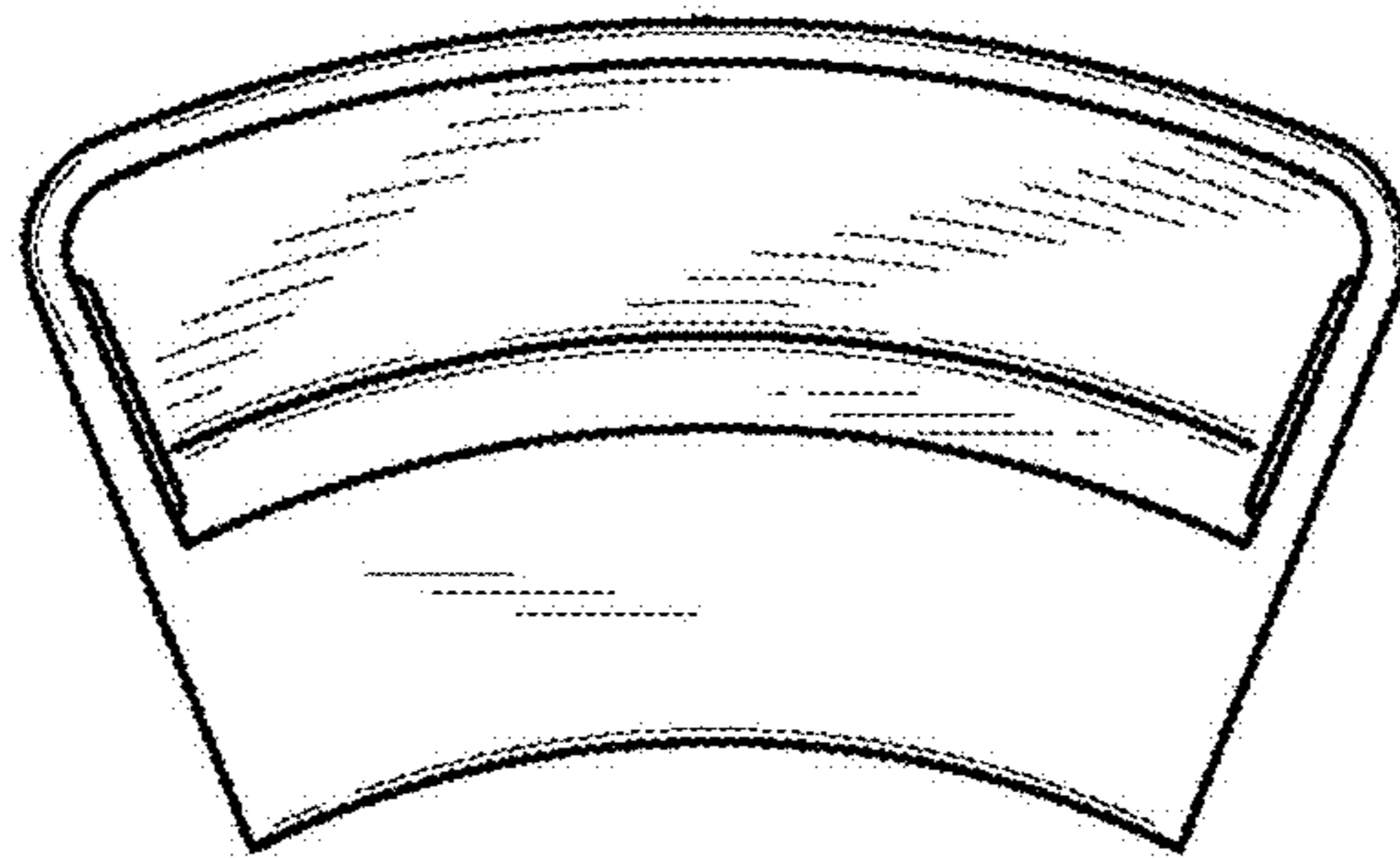

FIG. 5

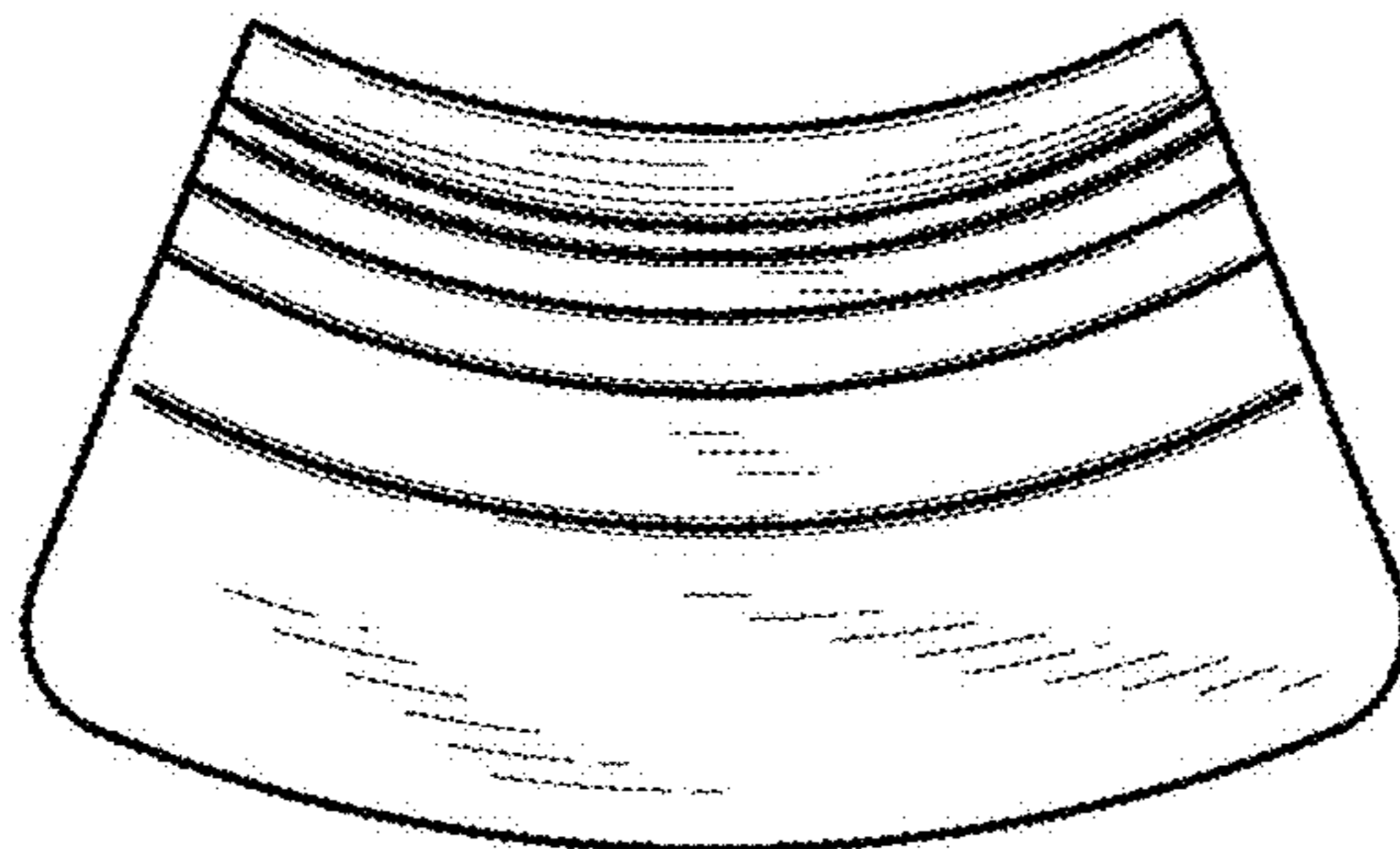

FIG. 6

FIG. 7

