



US00D845482S

(12) **United States Design Patent** (10) **Patent No.:** **US D845,482 S**  
**Lautemann et al.** (45) **Date of Patent:** **\*\* \*Apr. 9, 2019**

(54) **ARTHROSCOPIC MEDICAL INSTRUMENT**

- (71) Applicant: **KARL STORZ GmbH & Co. KG**, Tuttlingen (DE)
- (72) Inventors: **Kerstin Lautemann**, Braeunlingen (DE); **Michael Strobel**, Straubing (DE); **Tobias Unger**, Geisingen (DE)
- (73) Assignee: **KARL STORZ SE & Co. KG**, Tuttlingen (DE)
- (\*) Notice: This patent is subject to a terminal disclaimer.
- (\*\*) Term: **15 Years**

(21) Appl. No.: **29/535,768**

(22) Filed: **Aug. 10, 2015**

(30) **Foreign Application Priority Data**

Feb. 9, 2015 (EM) ..... 002629394-0004

(51) **LOC (11) Cl.** ..... **24-02**

(52) **U.S. Cl.**  
USPC ..... **D24/146**

(58) **Field of Classification Search**  
USPC ..... D24/133, 135, 138, 143, 144, 146-148;  
D8/19, 16; 600/564, 570  
CPC .. G09F 3/00; A61B 8/00; A61B 19/00; A61B 18/18; A61B 17/3207; A61B 17/3205; A61B 17/32; A61B 17/28; A61B 17/24; A61B 17/22; A61B 17/16; A61B 17/14;  
(Continued)

(56) **References Cited**

**U.S. PATENT DOCUMENTS**

- 5,397,320 A \* 3/1995 Essig ..... A61B 17/221  
606/110
- 5,667,480 A \* 9/1997 Knight ..... A61B 1/018  
128/898
- D391,370 S \* 2/1998 Cho ..... D24/147  
(Continued)

**OTHER PUBLICATIONS**

U.S. Appl. 29/514,374, filed Jan. 12, 2015, Huegle et al.

(Continued)

*Primary Examiner* — Eliza Z Bennett-Hattan

(74) *Attorney, Agent, or Firm* — Muncy, Geissler, Olds & Lowe, P.C.

(57) **CLAIM**

The ornamental design for an arthroscopic medical instrument, as shown and described.

**DESCRIPTION**

FIG. 1 is a front perspective enlarged partial view of an arthroscopic medical instrument according to the present invention.

FIG. 2 is a front enlarged partial view of the arthroscopic medical instrument of FIG. 1.

FIG. 3 is a rear enlarged partial view of the arthroscopic medical instrument of FIG. 1.

FIG. 4 is a left side enlarged partial view of the arthroscopic medical instrument of FIG. 1.

FIG. 5 is a right side enlarged partial view of the arthroscopic medical instrument of FIG. 1.

FIG. 6 is a top enlarged partial view of the arthroscopic medical instrument of FIG. 1.

FIG. 7 is a bottom enlarged partial view of the arthroscopic medical instrument of FIG. 1; and,

FIG. 8 is a front perspective view of the arthroscopic medical instrument.

The Arthroscopic medical Instrument is shown with a symbolic break in its length. The appearance of any portion of the article between the break lines forms no part of the claimed design.

The evenly spaced broken lines illustrate environment that does not form part of the claim; the dash-dot-dash lines represent claim boundaries and form no part of the claim.

**1 Claim, 7 Drawing Sheets**

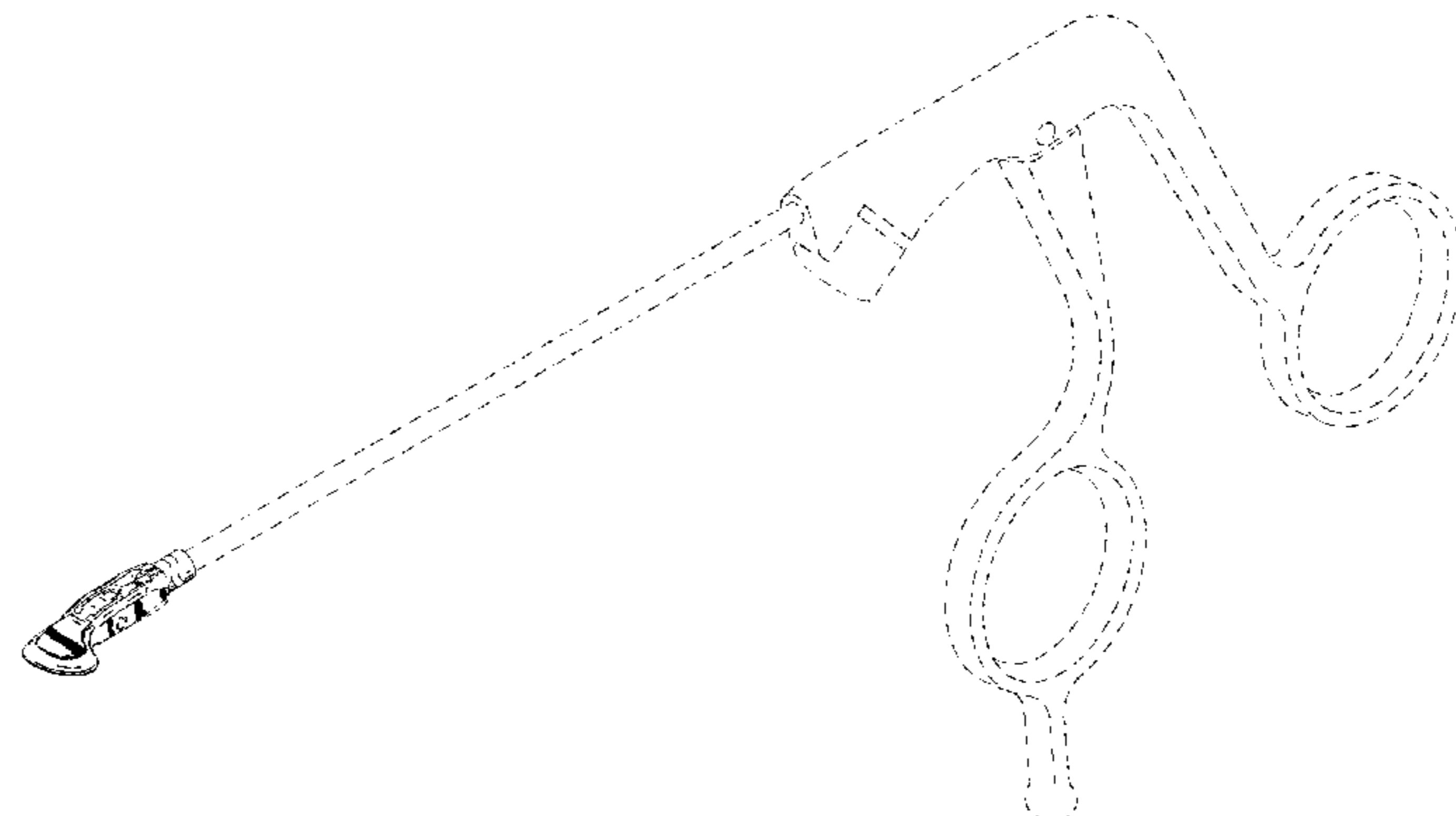
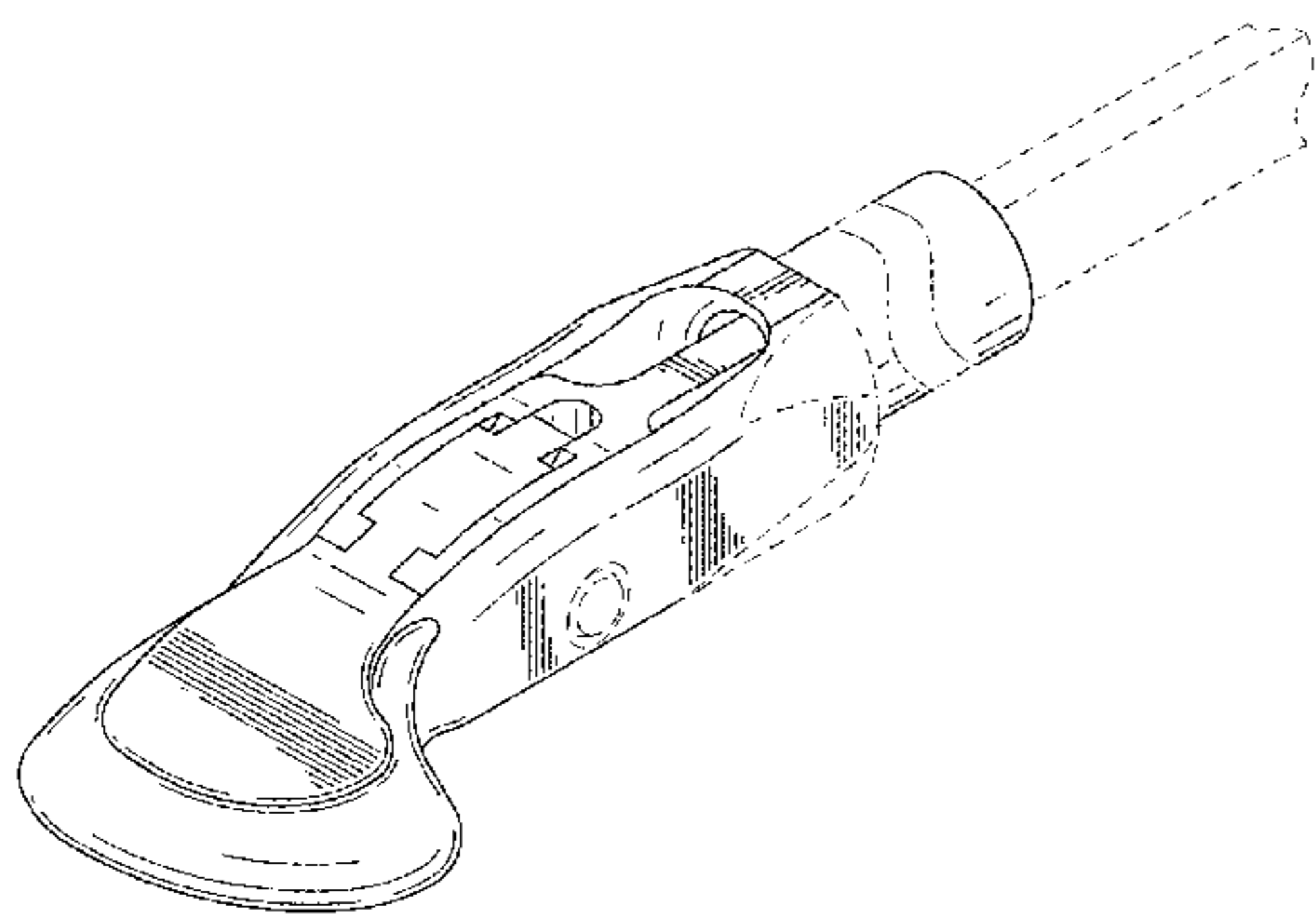

(58) **Field of Classification Search**  
 CPC ..... A61B 17/00; A61B 10/06; A61B 10/04;  
 A61B 10/02; A61B 1/12; A61B 1/00  
 See application file for complete search history.

(56) **References Cited**

U.S. PATENT DOCUMENTS

5,851,212 A \* 12/1998 Zirps ..... A61B 17/32002  
 606/167  
 5,902,315 A \* 5/1999 DuBois ..... A61B 1/018  
 600/210  
 6,010,523 A \* 1/2000 Sabin ..... A61B 10/06  
 600/562  
 D438,305 S \* 2/2001 Ripich ..... D24/147  
 D496,102 S \* 9/2004 Watermeier ..... D24/133  
 6,960,164 B2 \* 11/2005 O’Heeron ..... A61B 17/3417  
 600/114  
 D548,836 S \* 8/2007 Lang ..... D24/146  
 D610,680 S \* 2/2010 Blocher ..... D24/133  
 D612,049 S \* 3/2010 Baynham ..... D24/133  
 D626,223 S \* 10/2010 Bender ..... D24/135  
 D629,902 S \* 12/2010 Palmer ..... D24/144  
 D636,874 S \* 4/2011 Palmer ..... D24/146

7,985,239 B2 \* 7/2011 Suzuki ..... A61B 10/0096  
 606/205  
 D691,266 S 10/2013 Fink et al.  
 D691,721 S 10/2013 Scheibel et al.  
 D733,300 S \* 6/2015 Bennett ..... D24/147  
 D737,442 S \* 8/2015 Hasebe ..... D24/146  
 D738,502 S \* 9/2015 Jian ..... D24/146  
 D756,513 S \* 5/2016 Cheney ..... D24/133  
 D760,894 S \* 7/2016 Cheney ..... D24/133  
 2003/0212343 A1 \* 11/2003 Plishka ..... A61B 10/0275  
 600/564  
 2009/0299217 A1 \* 12/2009 Bleibach ..... A61B 10/04  
 600/564

OTHER PUBLICATIONS

Karl Storz, Silcut—The Art of Cutting,; Endoworld Art. 25 10.0, pp. 1-12 with English translation (Jun. 2015).  
 Karl Storz, “Silcut 1: Experience Meets Innovation,” Endoworld Art 47-3, pp. 1-12 (Jul. 2014).  
 Karl Storz, “Arthroforce One: Experience Meets Innovation,” Endoworld Art. 47-2, pp. 1-8 with English translation (Mar. 2013).

\* cited by examiner

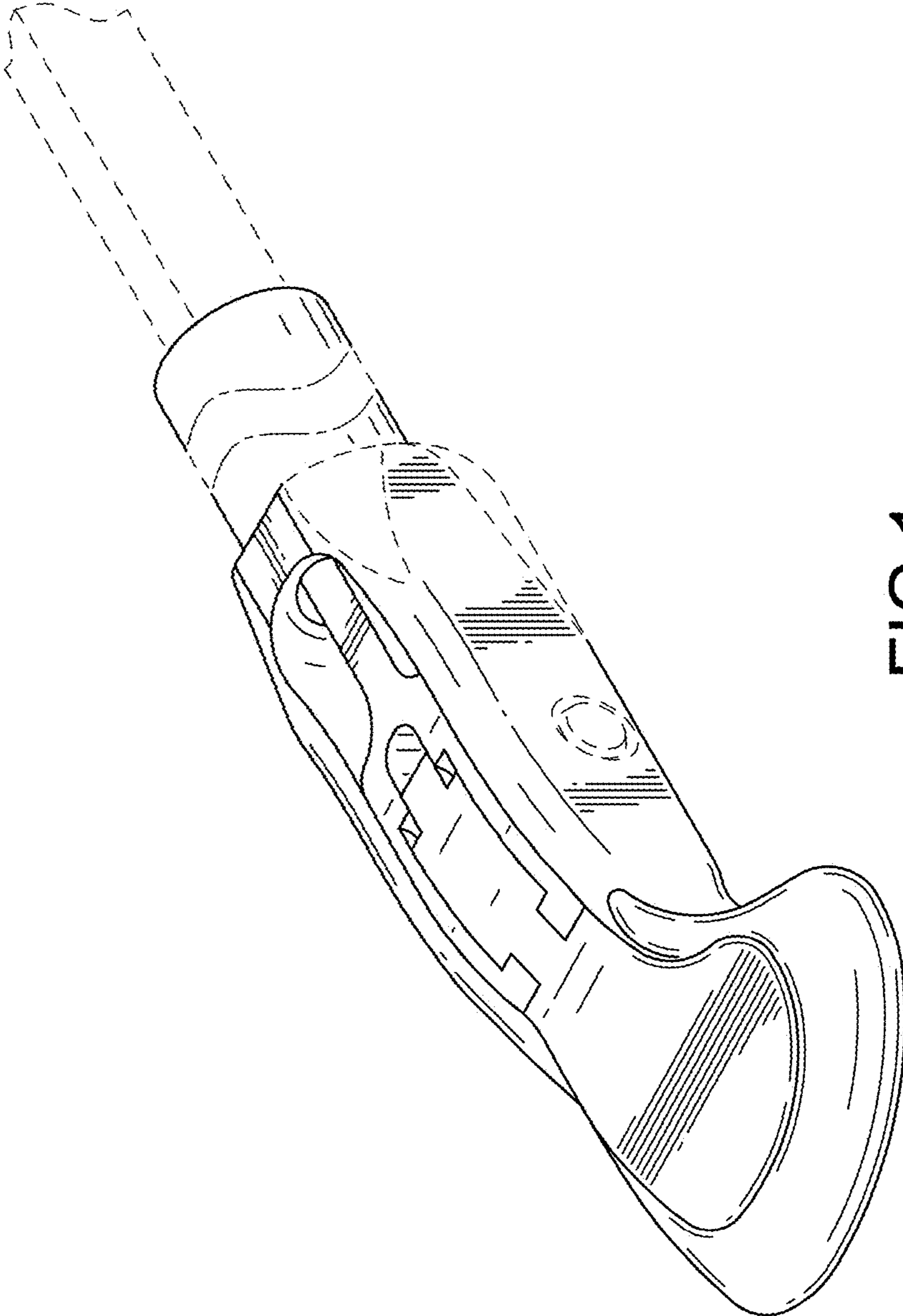

FIG.1

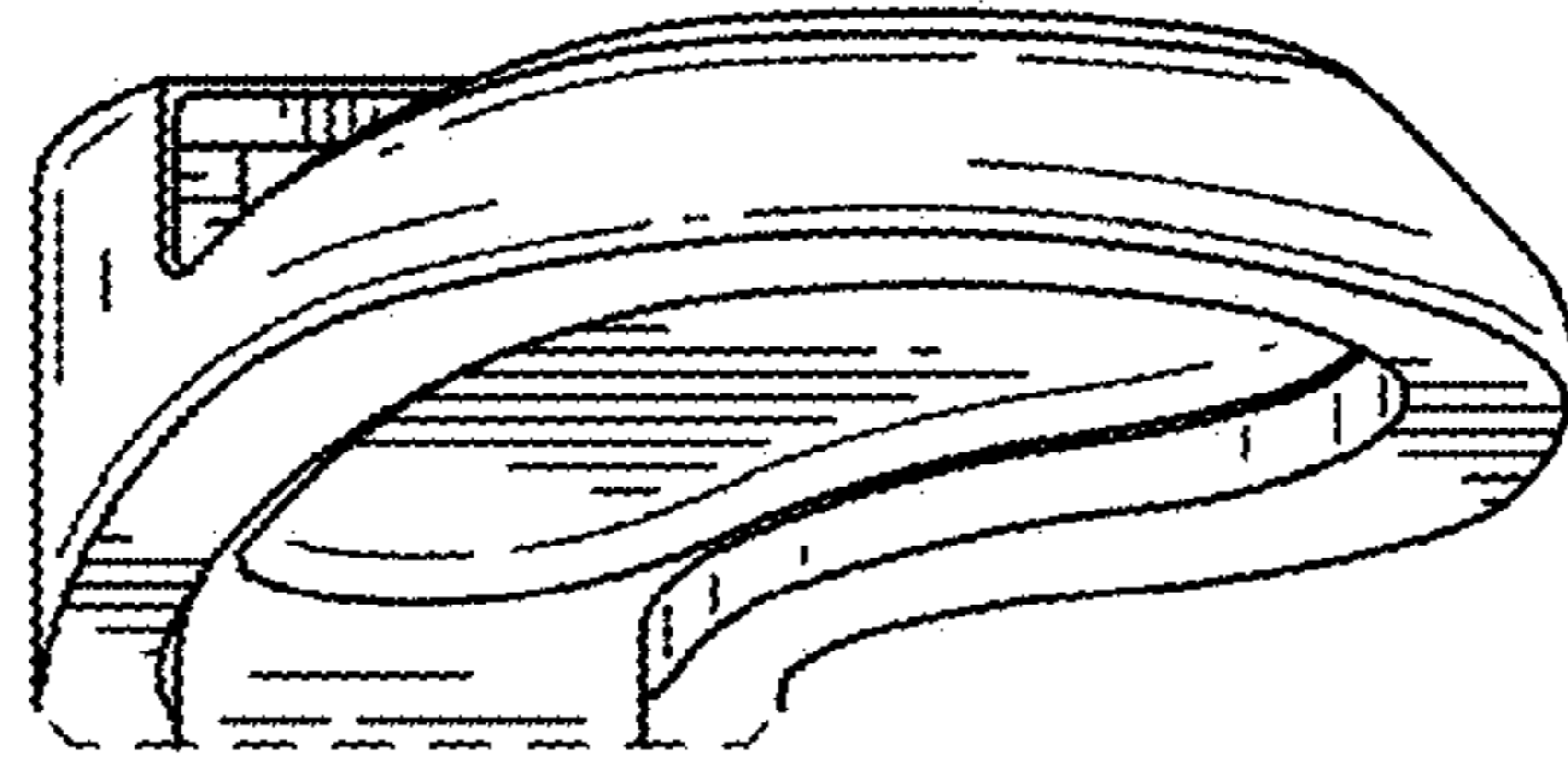

FIG. 2

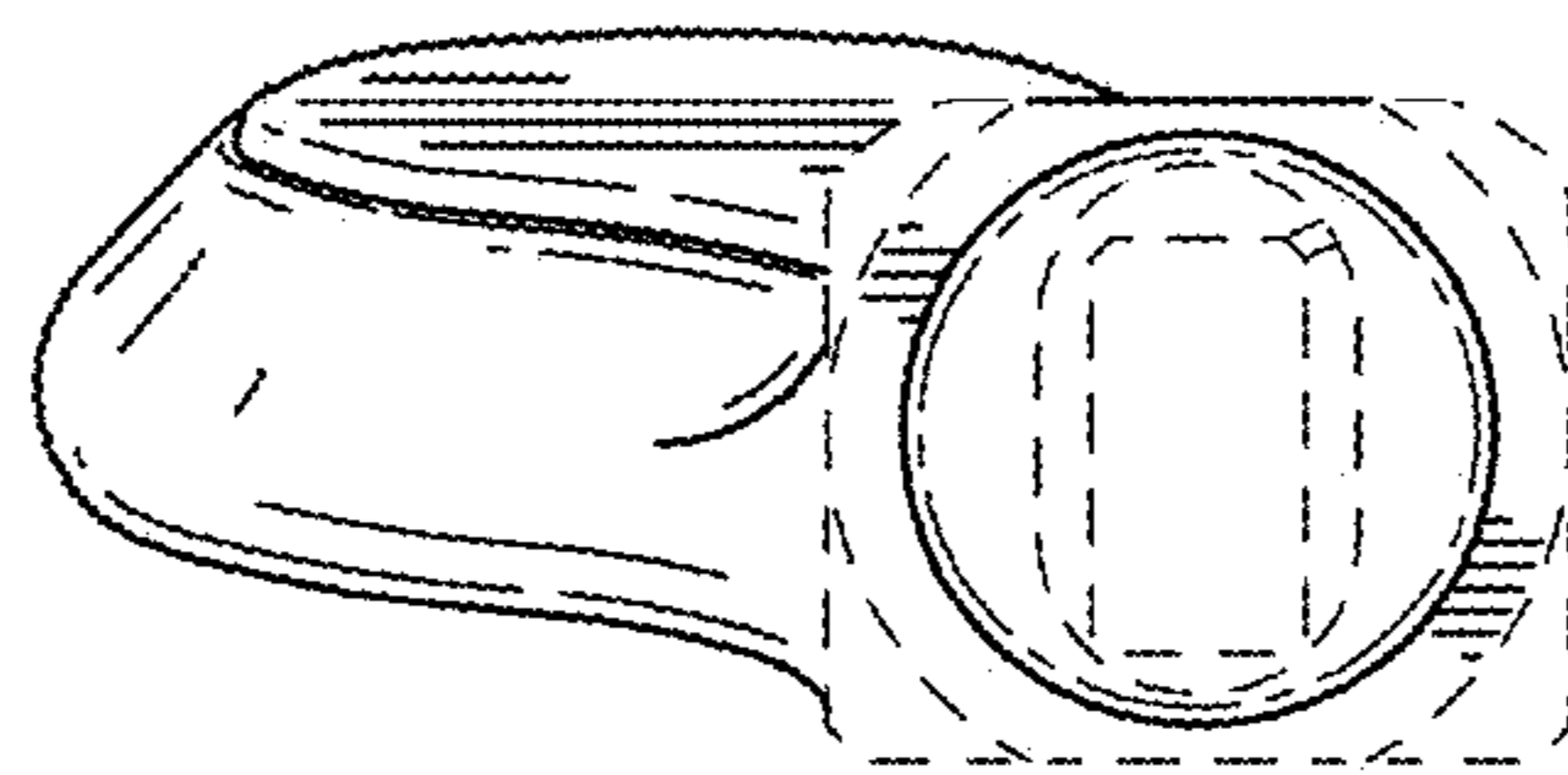

FIG. 3

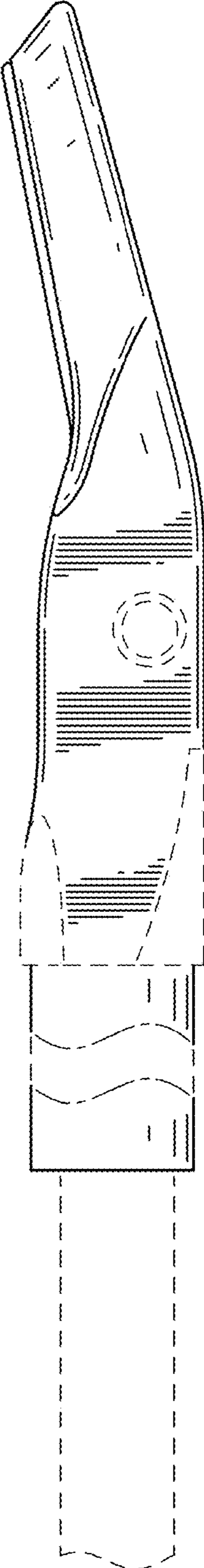

FIG. 4

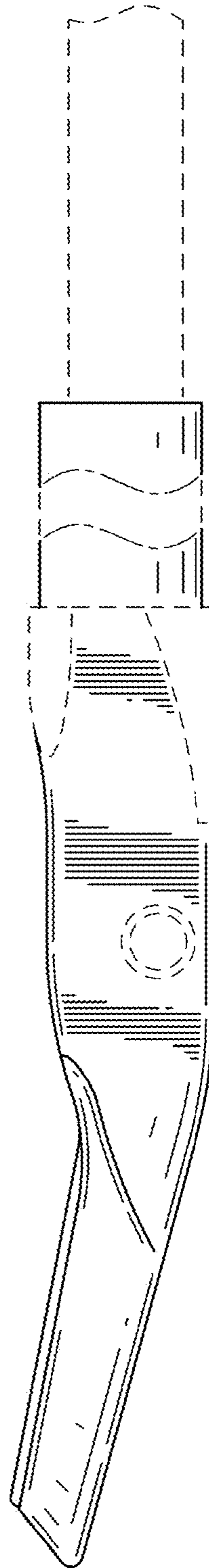

FIG.5

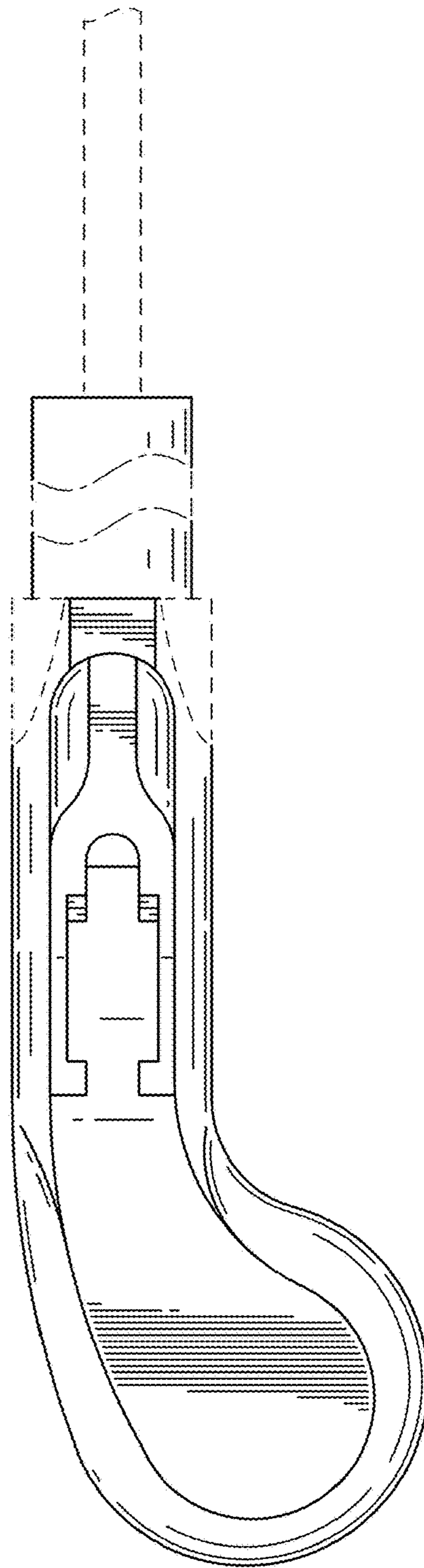

FIG. 6

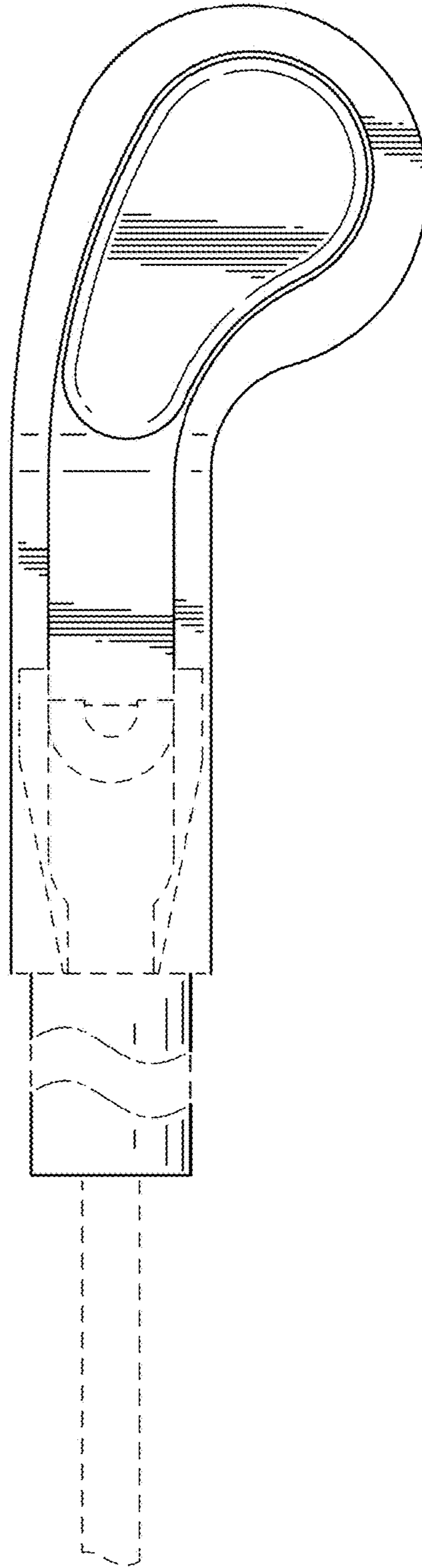

FIG.7



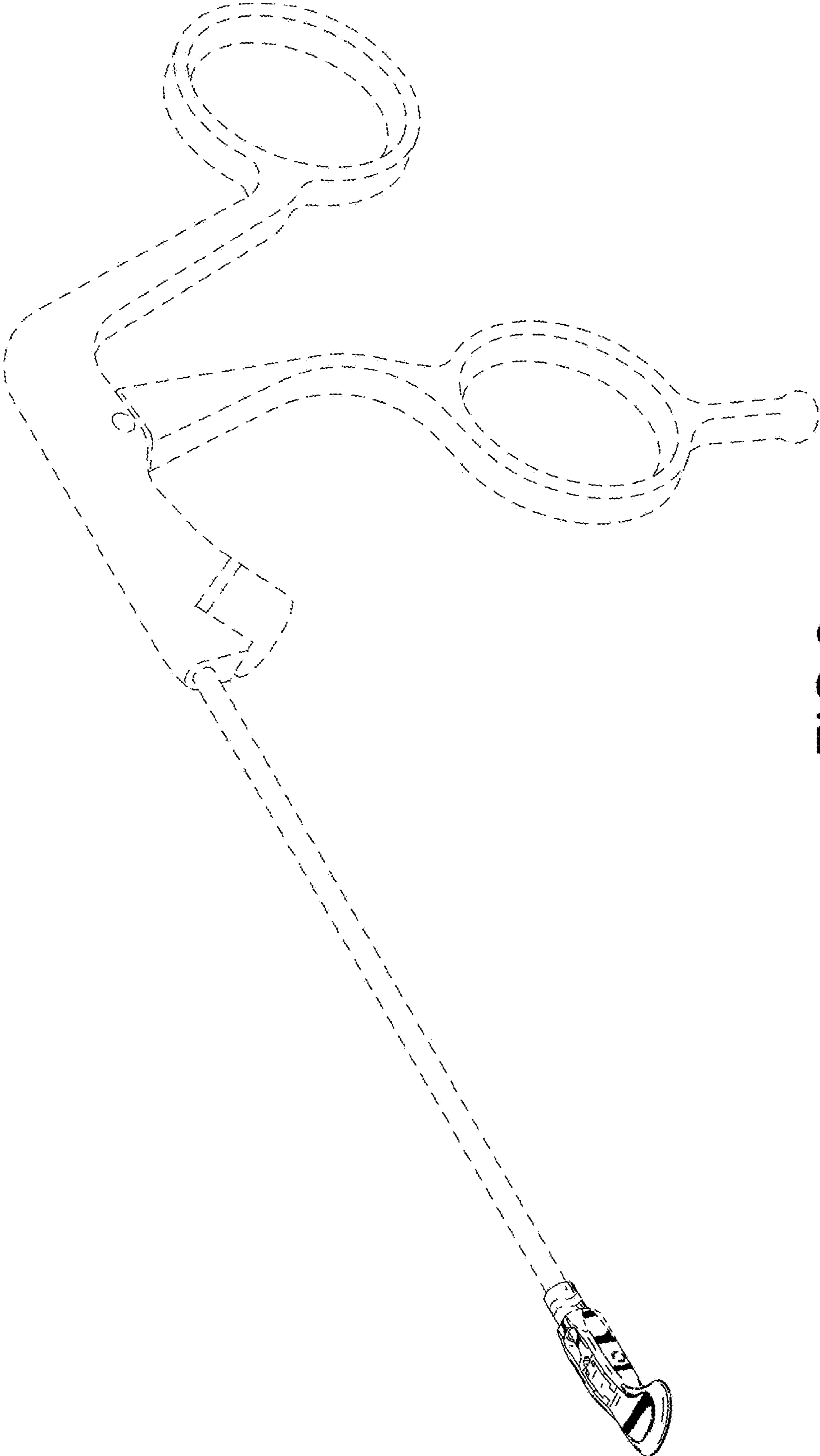

FIG.8