



US00D845445S

(12) **United States Design Patent**
Fritz

(10) **Patent No.:** **US D845,445 S**

(45) **Date of Patent:** **** Apr. 9, 2019**

(54) **FAUCET SPOUT**

(71) Applicant: **DELTA FAUCET COMPANY,**
Indianapolis, IN (US)

(72) Inventor: **Seth Fritz,** Carmel, IN (US)

(73) Assignee: **DELTA FAUCET COMPANY,**
Indianapolis, IN (US)

(**) Term: **15 Years**

(21) Appl. No.: **29/640,906**

(22) Filed: **Mar. 19, 2018**

(51) **LOC (11) Cl.** **23-01**

(52) **U.S. Cl.**
USPC **D23/255**

(58) **Field of Classification Search**
USPC D23/238–243, 249, 255, 257
CPC Y10T 137/9464
See application file for complete search history.

(56) **References Cited**

U.S. PATENT DOCUMENTS

D304,225 S * 10/1989 Lathrop D23/257
D368,958 S * 4/1996 Hill D23/255

D492,392 S * 6/2004 Pohl D23/241
D530,396 S * 10/2006 Smith D23/238
D540,916 S * 4/2007 Toyohara D23/241
D582,516 S * 12/2008 Lobermeier D23/238
D607,974 S * 1/2010 Flowers D23/238
D619,221 S * 7/2010 Kulig D23/242
D757,912 S * 5/2016 Eads D23/255

* cited by examiner

Primary Examiner — Robert A Delehanty

(74) *Attorney, Agent, or Firm* — Edgar A. Zarins; Nirav D. Parikh

(57) **CLAIM**

The ornamental design for a faucet spout, as shown and described.

DESCRIPTION

FIG. 1 is a front perspective view of a faucet spout showing my new design;
FIG. 2 is a rear perspective view thereof;
FIG. 3 is a front elevational view thereof;
FIG. 4 is a left side view thereof;
FIG. 5 is a rear view thereof;
FIG. 6 is a right side view thereof;
FIG. 7 is a top plan view thereof; and,
FIG. 8 is a bottom view thereof.

1 Claim, 4 Drawing Sheets

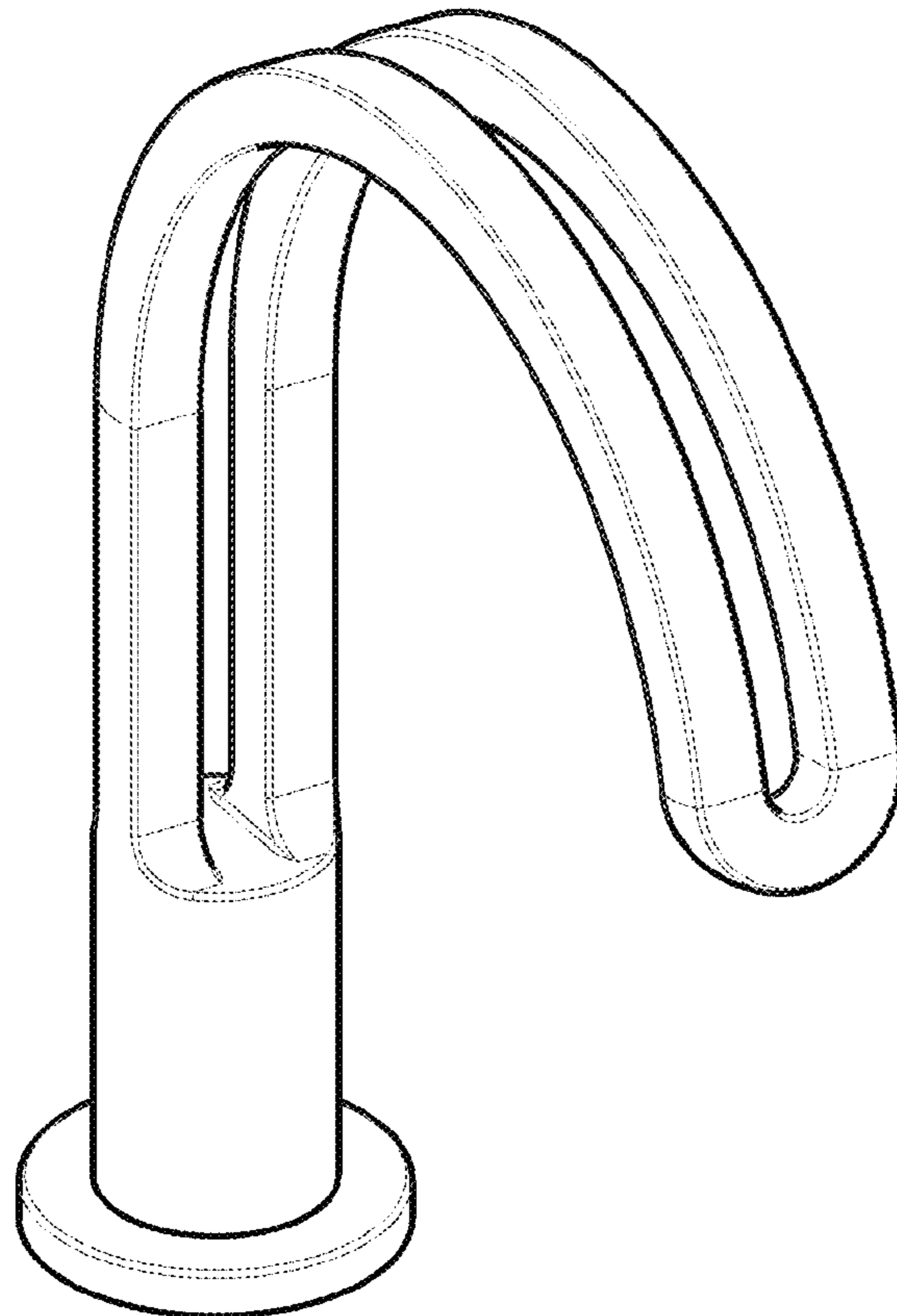

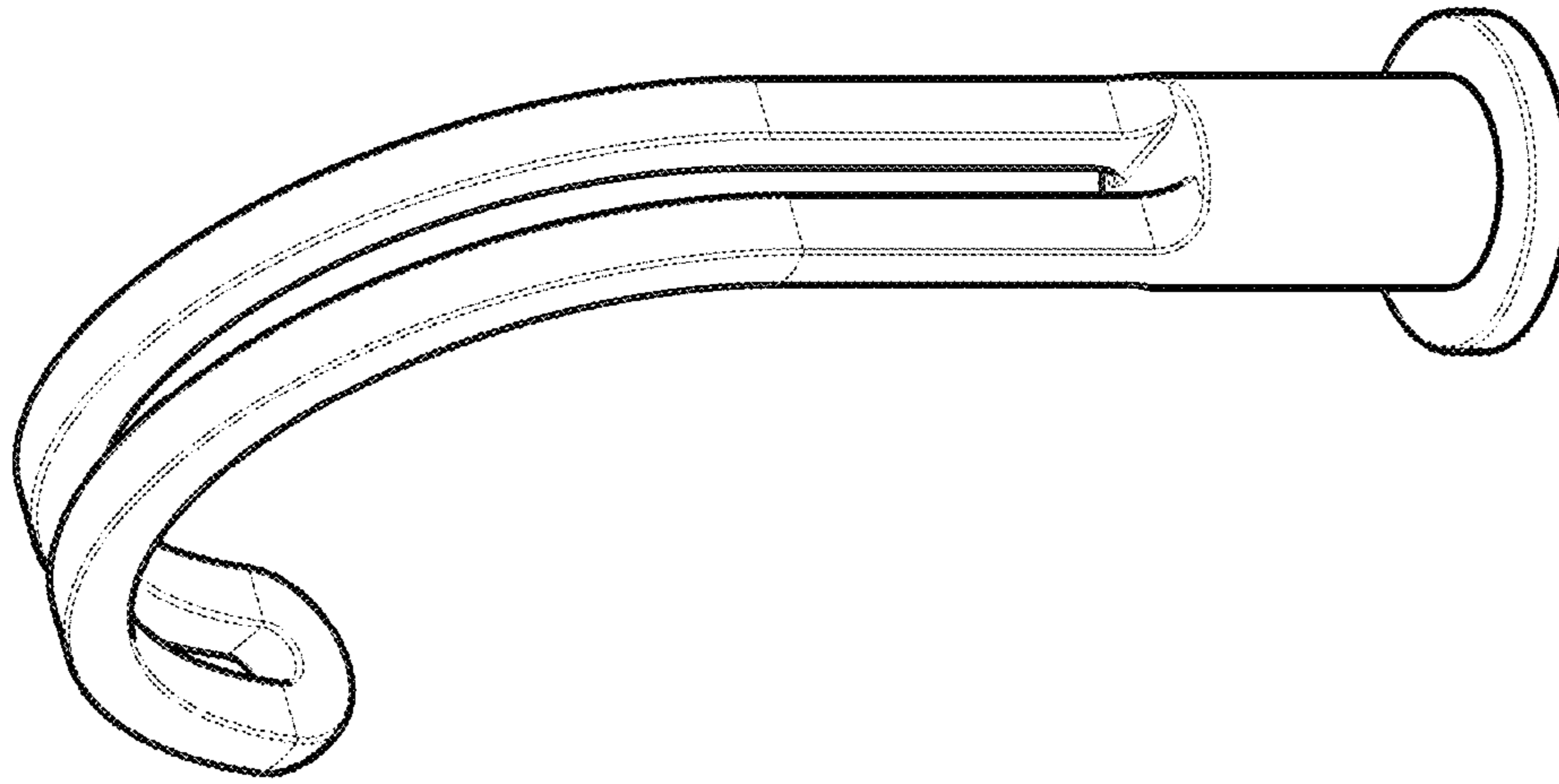

Fig. 2

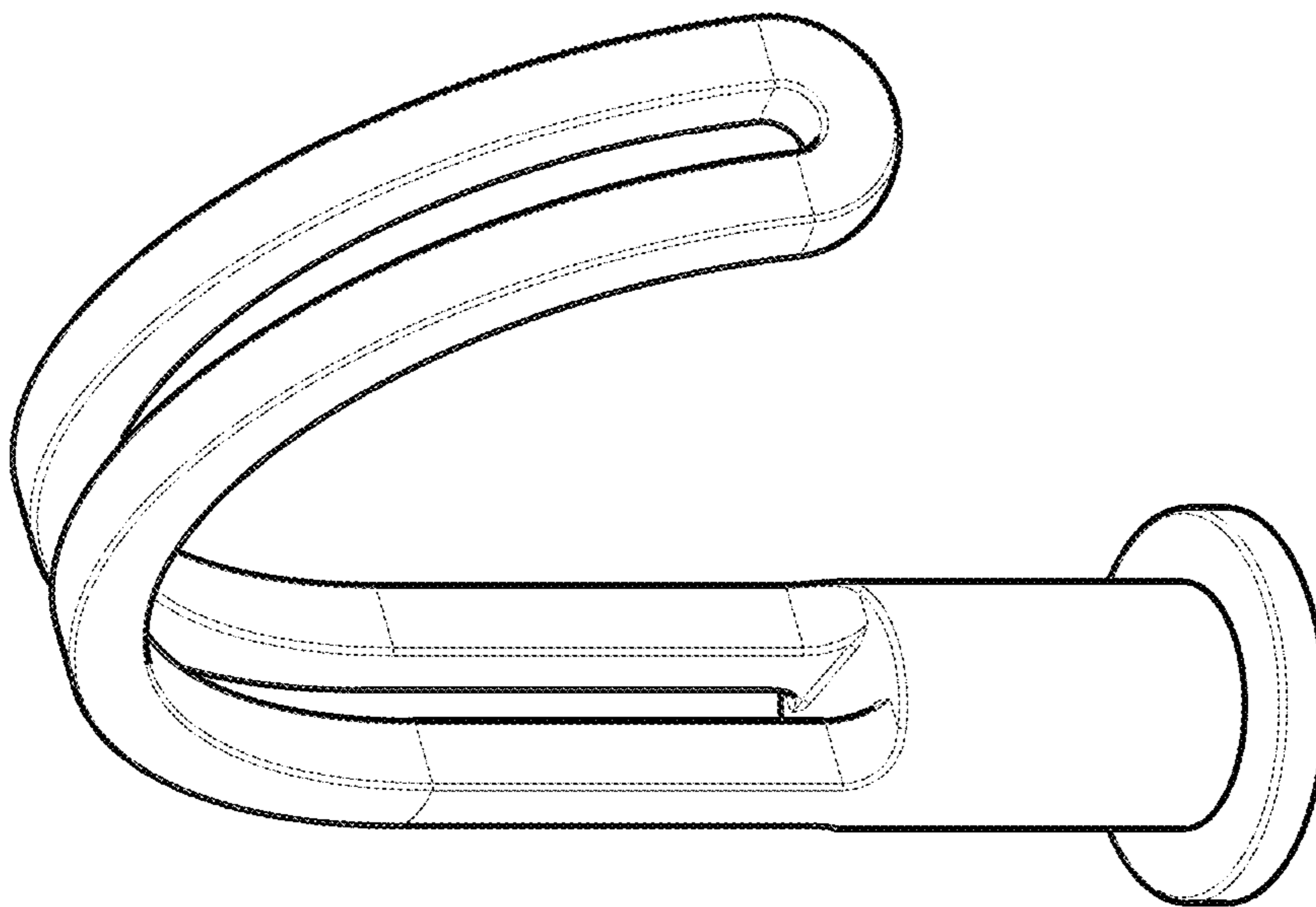

Fig. 1

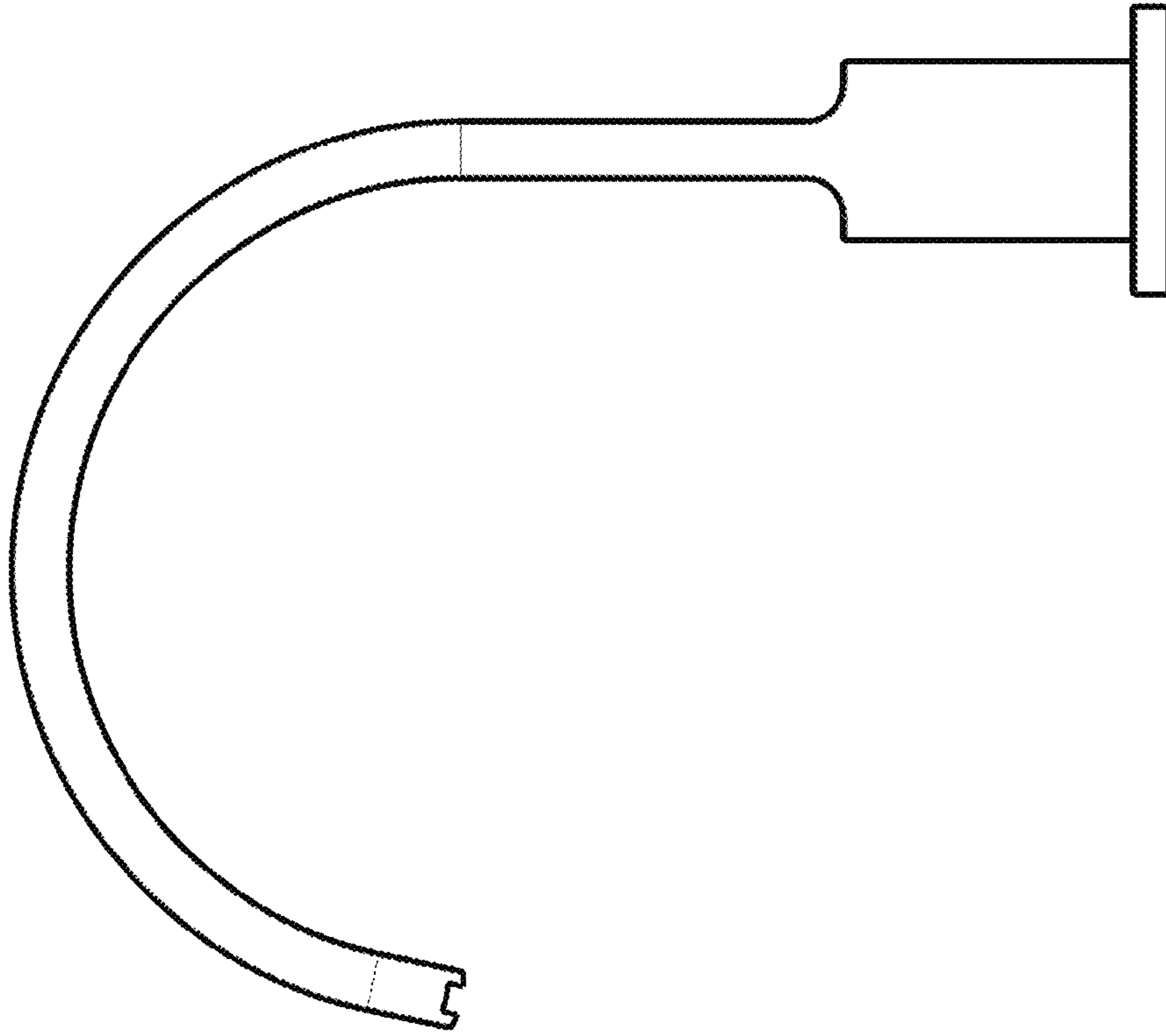

Fig. 3

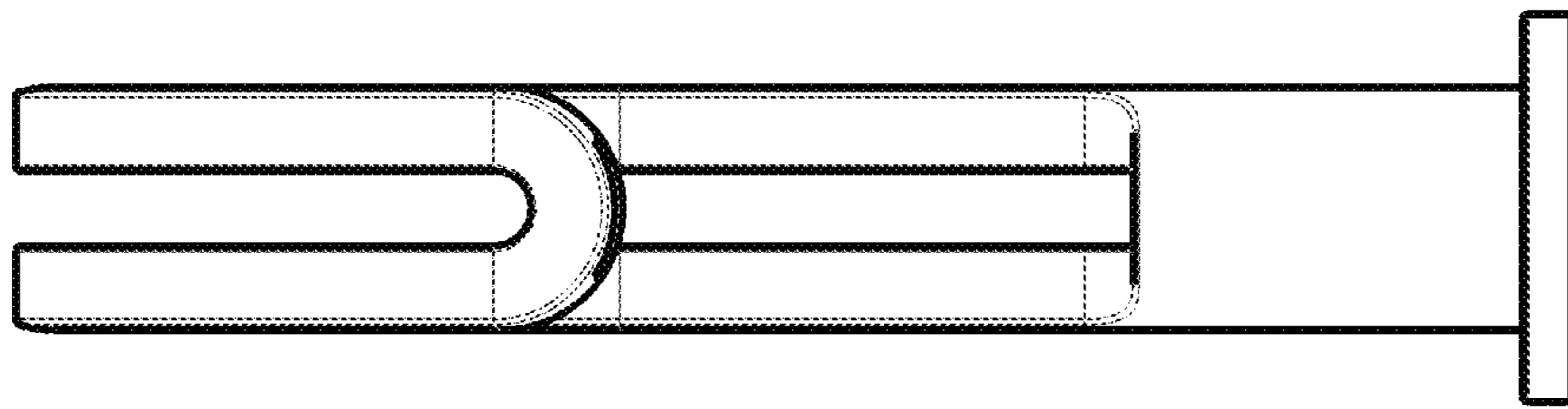

Fig. 4

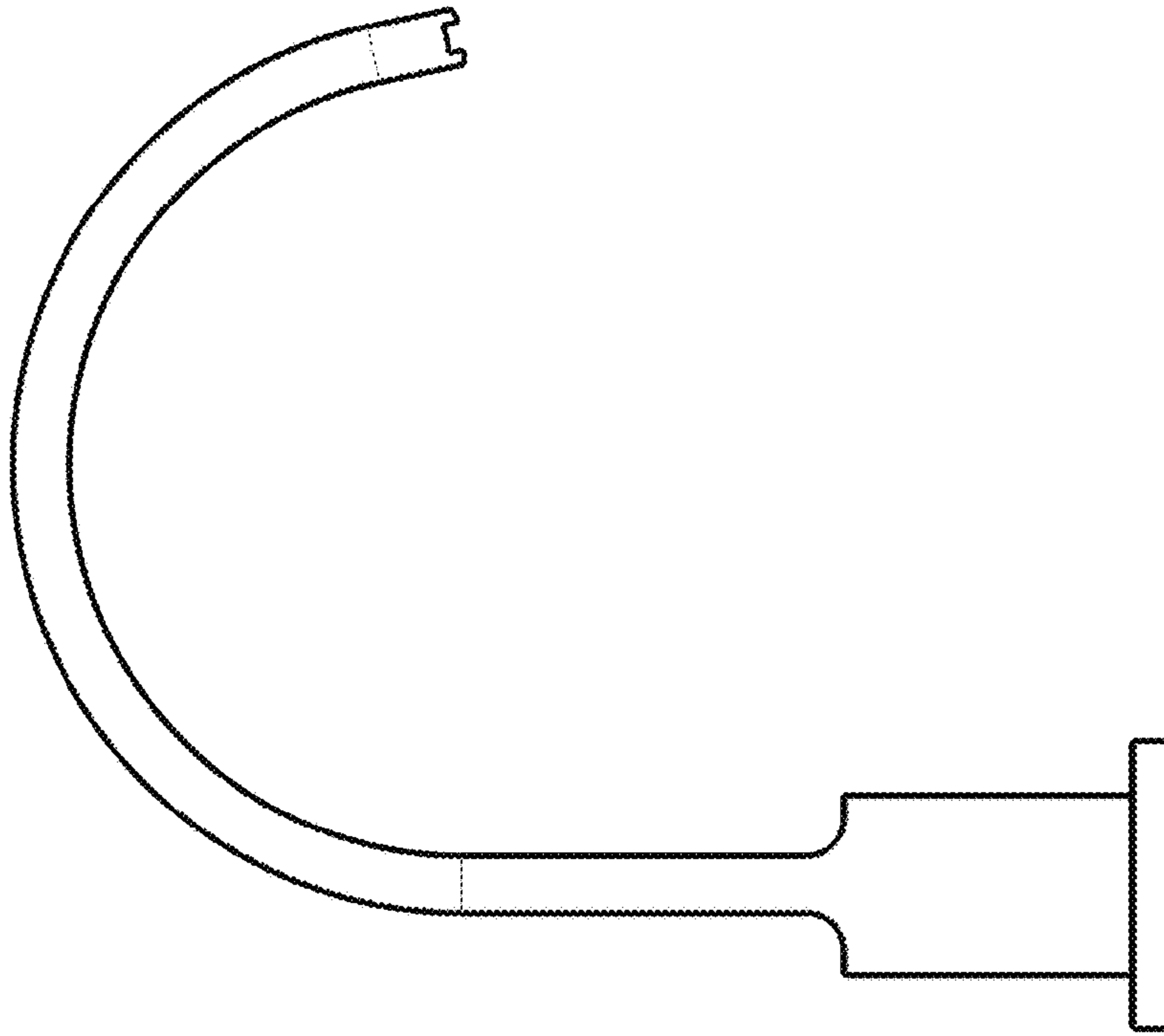

Fig. 5

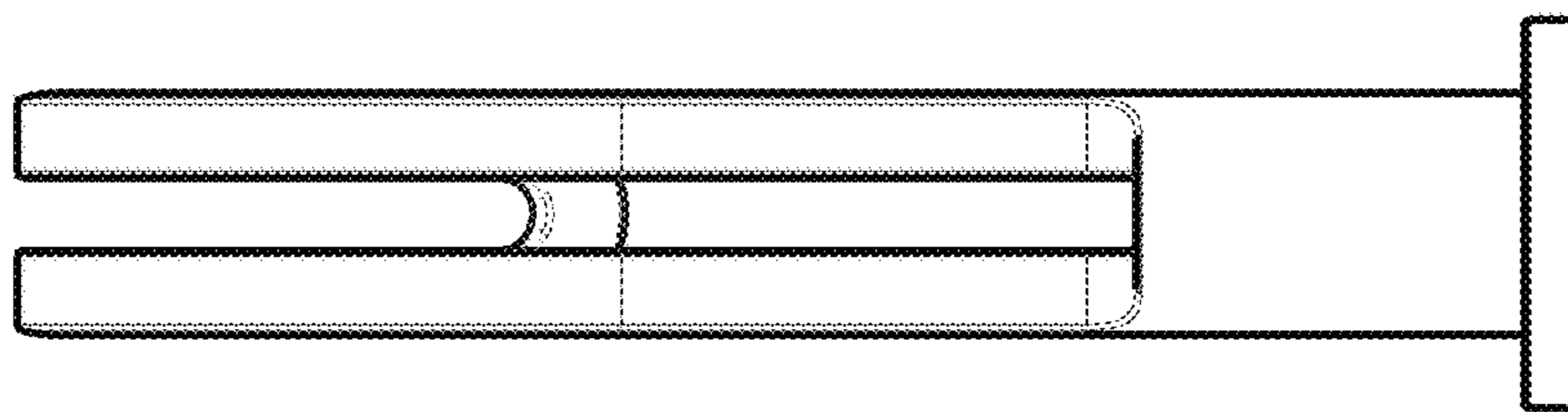

Fig. 6

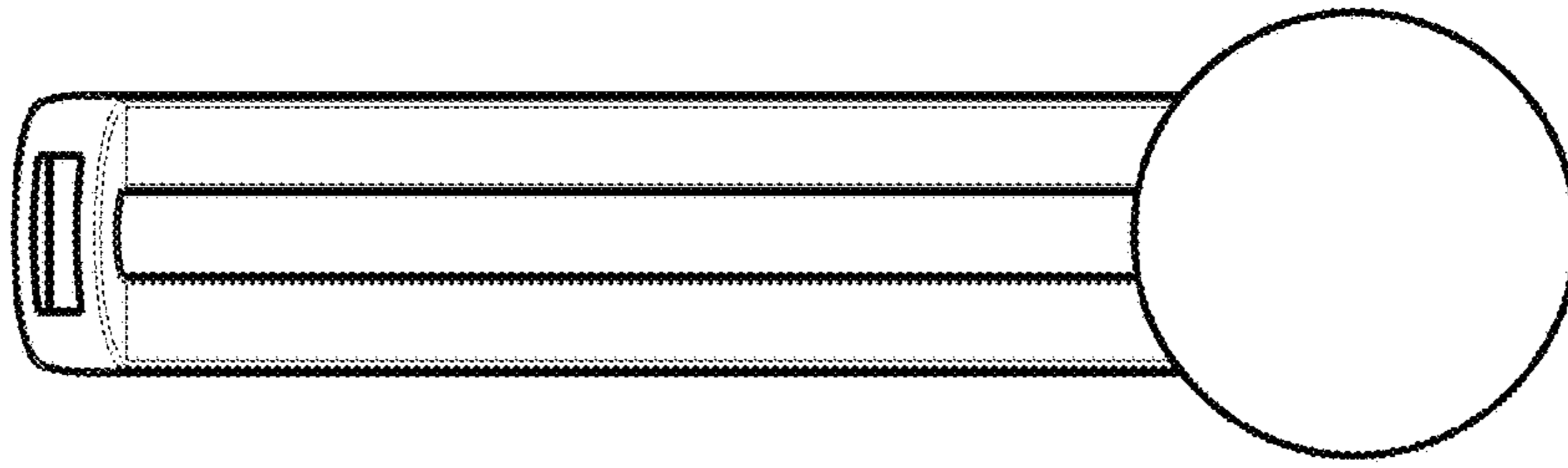

Fig. 8

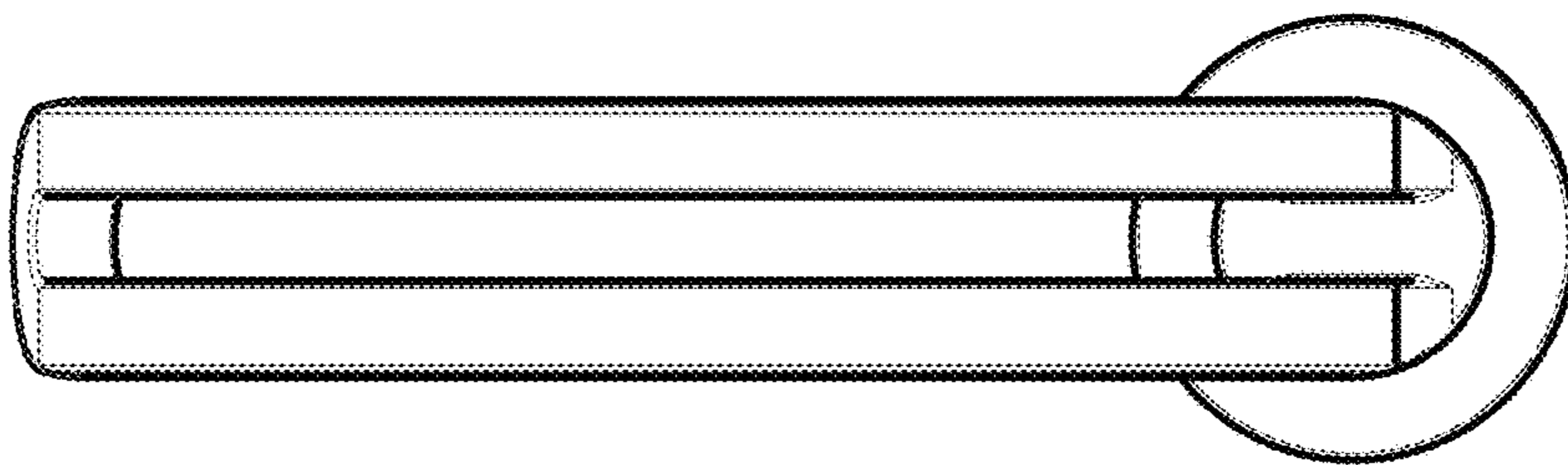

Fig. 7