



US00D845371S

(12) **United States Design Patent** (10) **Patent No.:** **US D845,371 S**
Turner (45) **Date of Patent:** **** Apr. 9, 2019**

(54) **SNORKEL GEAR**
(71) Applicant: **Daniel Turner**, Humble, TX (US)
(72) Inventor: **Daniel Turner**, Humble, TX (US)
(**) Term: **15 Years**
(21) Appl. No.: **29/591,836**

D807,419 S * 1/2018 Herrmann D15/148
D834,074 S * 11/2018 Palushaj D15/126
2004/0069086 A1 * 4/2004 Thoma F16H 55/18
74/443
2005/0063794 A1 * 3/2005 Fleytman F16H 1/125
409/48
2010/0075795 A1 * 3/2010 Krude F16H 1/12
475/220
2016/0108490 A1 * 4/2016 Eto C21D 9/32
148/223

(22) Filed: **Jan. 24, 2017**
(51) **LOC (11) Cl.** **15-09**
(52) **U.S. Cl.**
USPC **D15/148**
(58) **Field of Classification Search**
USPC D15/148-149, 126, 138; 74/411, 572.1,
74/572.2, 573.1-573.13, 574.1-574.4,
74/571.21; 464/34, 73, 74, 76, 81-84,
464/894
CPC A01K 89/01; B29C 45/0025; B29L
2015/003; F16H 1/46; F16H 37/08; F16H
55/06; F16H 2055/065; F16H 2055/173;
F16H 48/12; F16H 48/29; F16H
2048/102; Y10S 475/904
See application file for complete search history.

OTHER PUBLICATIONS

Office Action in related Canadian Intellectual Property Office appli-
cation 176000 dated Jan. 18, 2018, 1 page.

* cited by examiner

Primary Examiner — David G Muller
Assistant Examiner — Nathan M Johnston
(74) *Attorney, Agent, or Firm* — Law Office of Jeff
Williams; J. Oliver Williams

(57) **CLAIM**

The ornamental design for a snorkel gear, as shown and
described.

DESCRIPTION

FIG. 1 is a top perspective view of the snorkel gear showing
my new design.
FIG. 2 is a front elevation view thereof.
FIG. 3 is a rear elevation view thereof.
FIG. 4 is a right elevation view thereof.
FIG. 5 is a left elevation view thereof.
FIG. 6 is a top plan view thereof.
FIG. 7 is a bottom plan view thereof; and,
FIG. 8 is a bottom perspective view thereof.

(56) **References Cited**
U.S. PATENT DOCUMENTS
6,408,719 B1 * 6/2002 Seki F16H 48/147
475/230
D582,445 S * 12/2008 Yanase D15/126
D656,170 S * 3/2012 Costa Pujadas D15/148
D660,888 S * 5/2012 Piliguian D15/126
D724,635 S * 3/2015 Eisenblatter D15/126
D740,866 S * 10/2015 Herrmann D15/148
D782,549 S * 3/2017 Takai D15/126

1 Claim, 6 Drawing Sheets

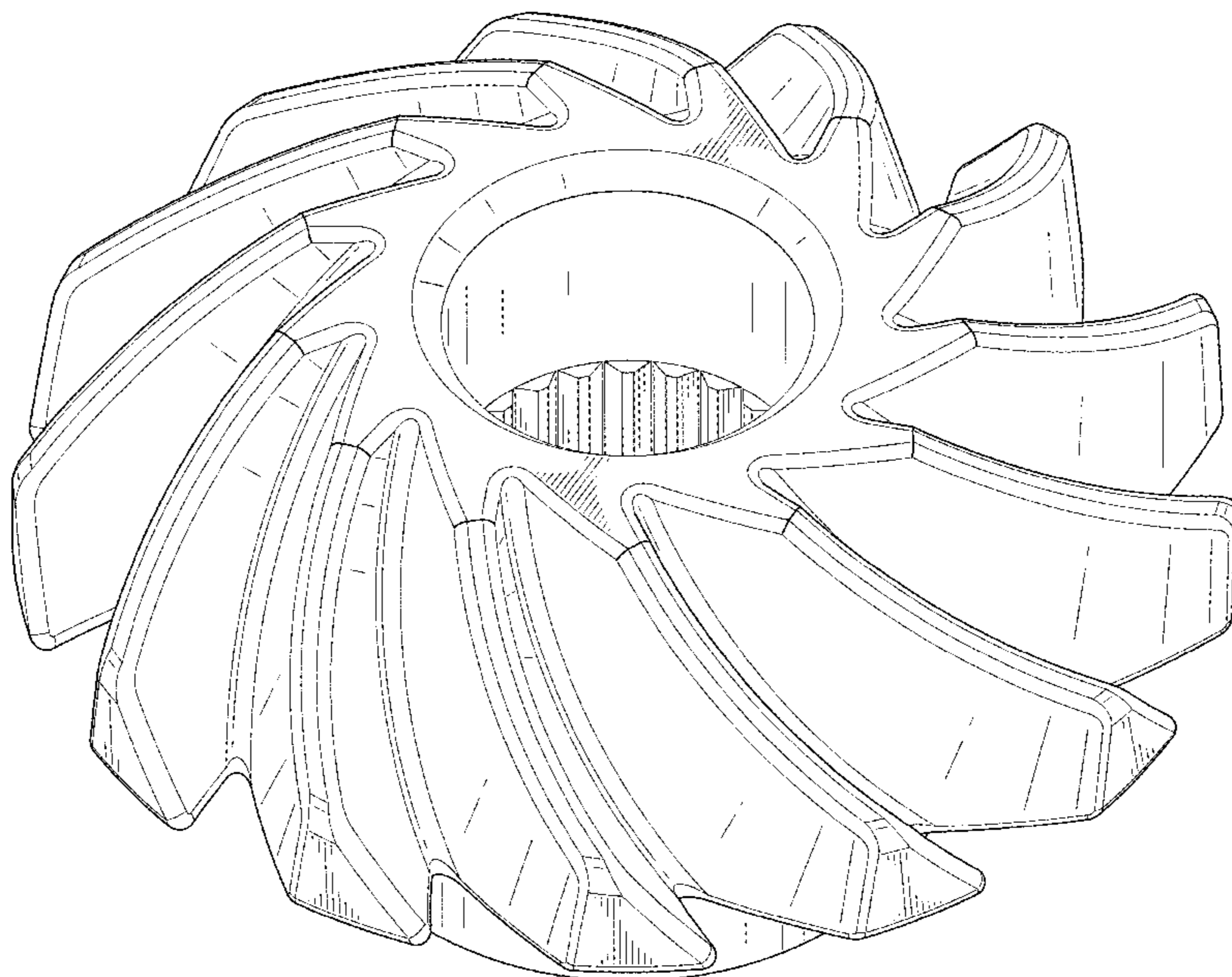

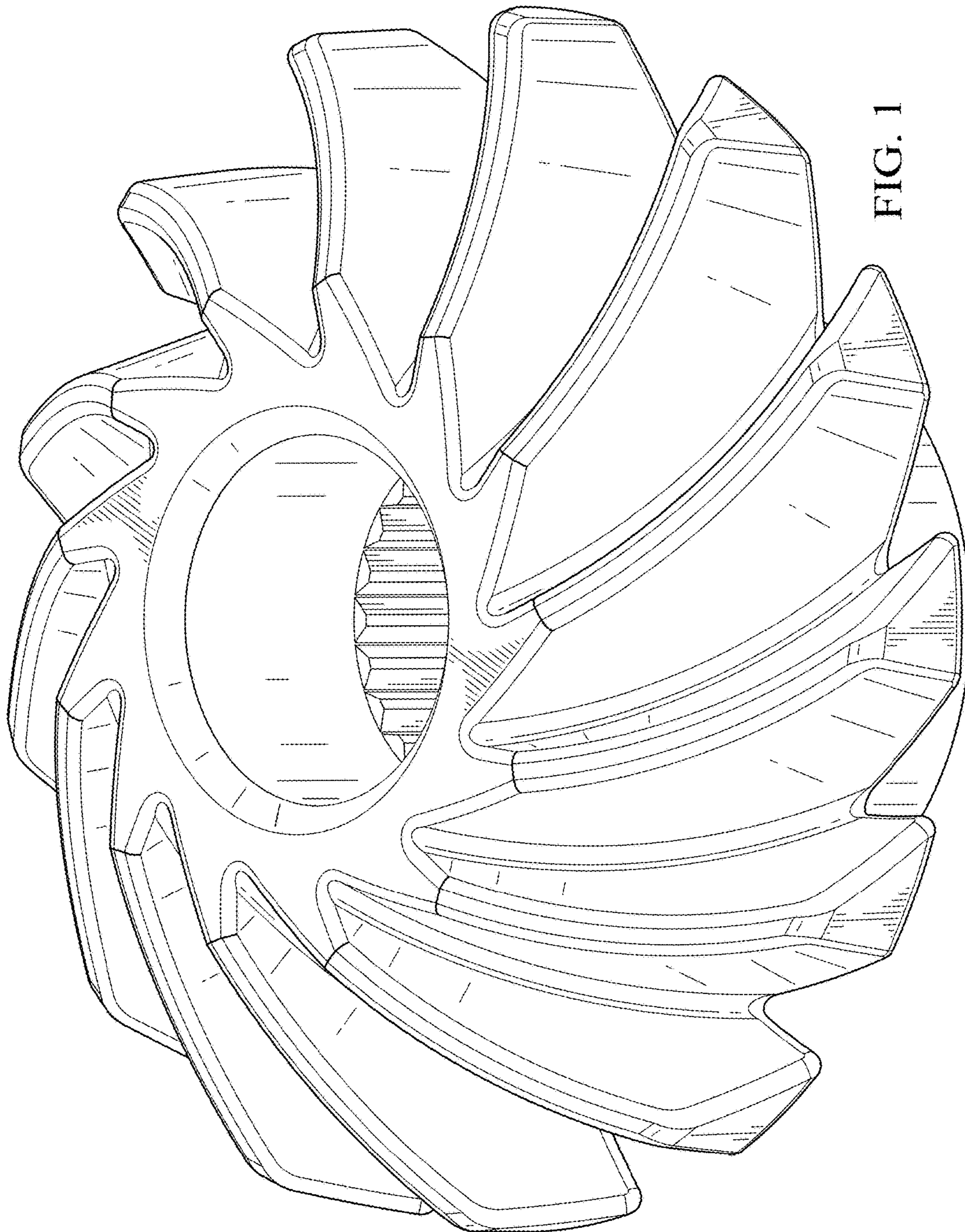

FIG. 1

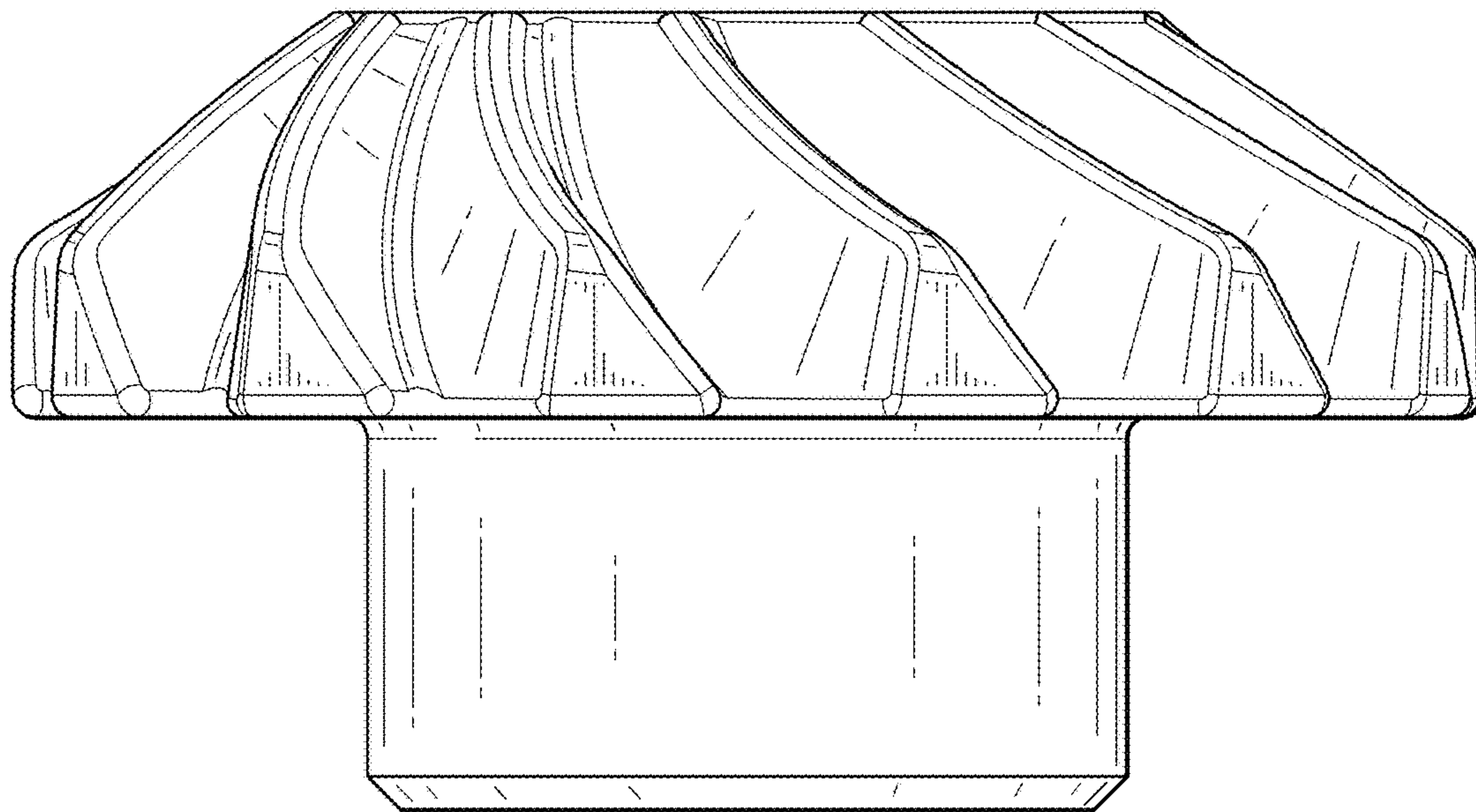

FIG. 2

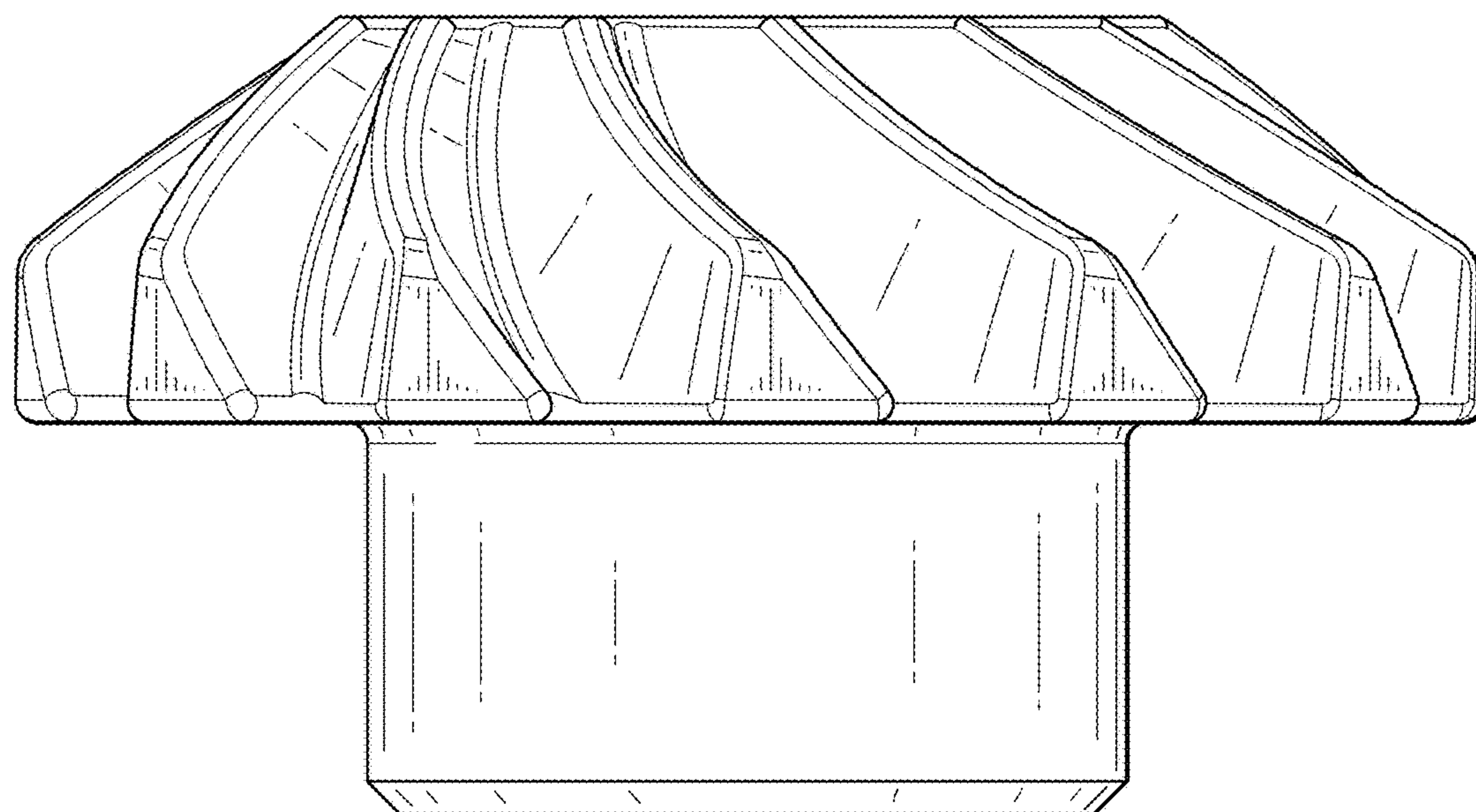

FIG. 3

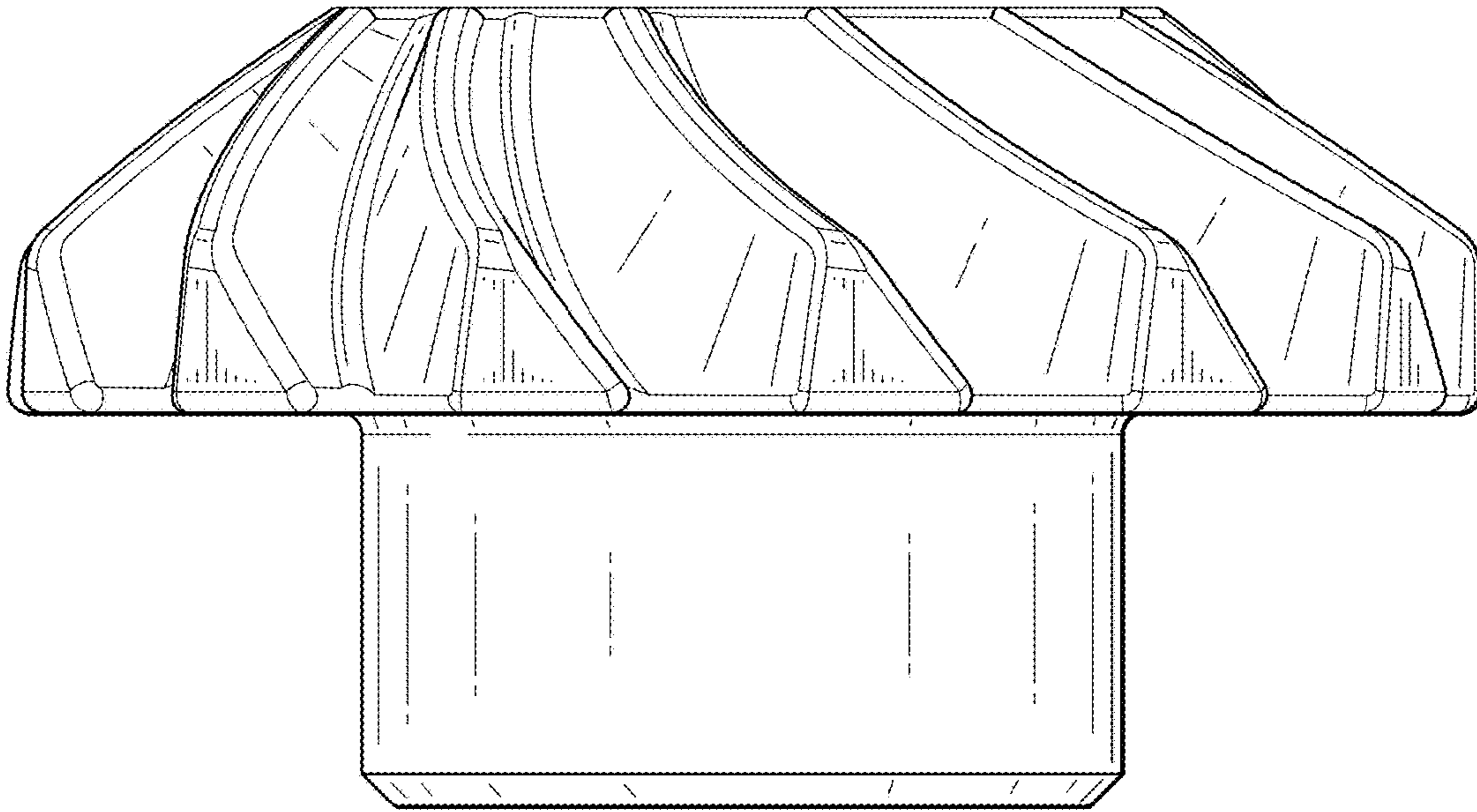

FIG. 4

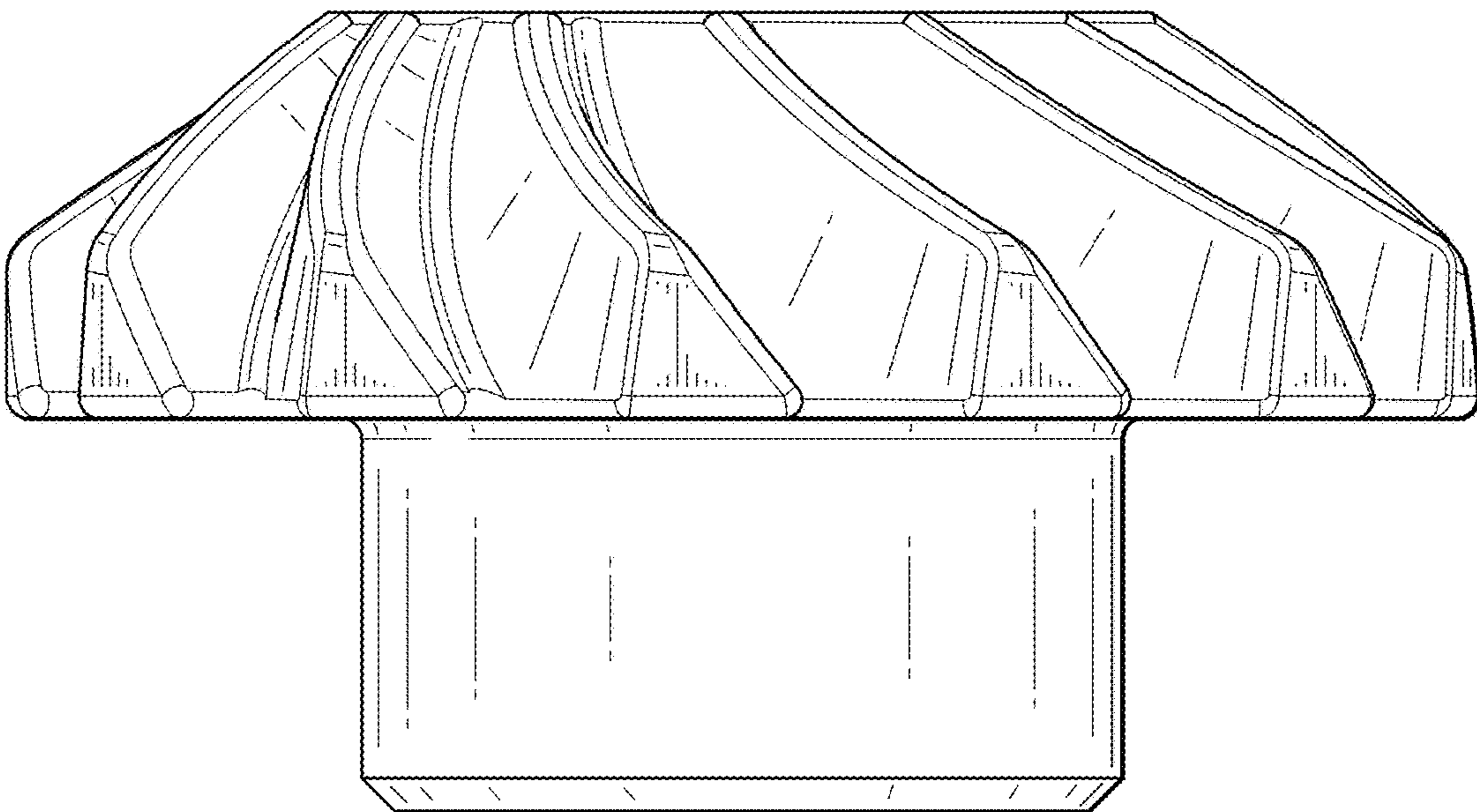

FIG. 5

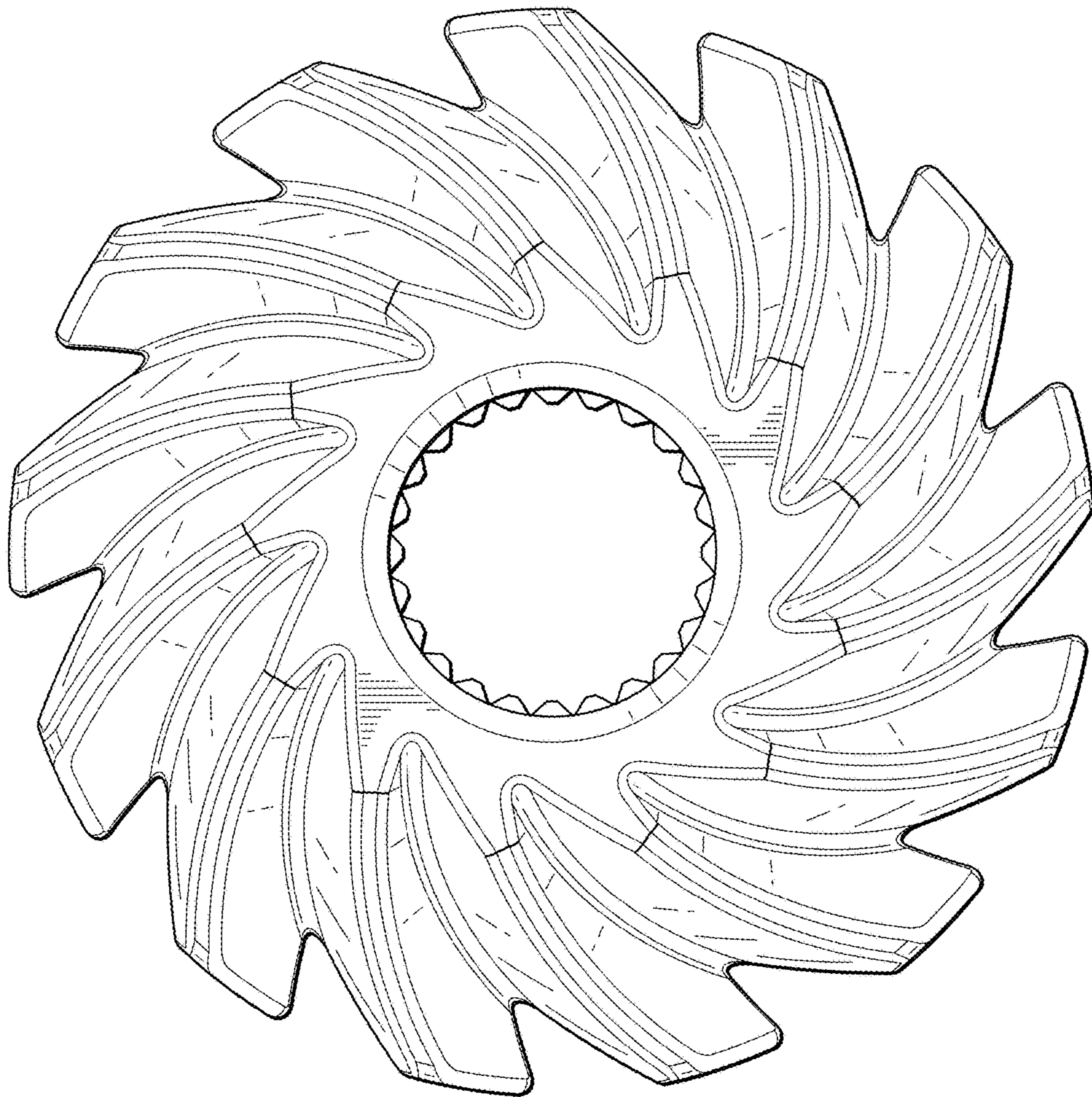

FIG. 6

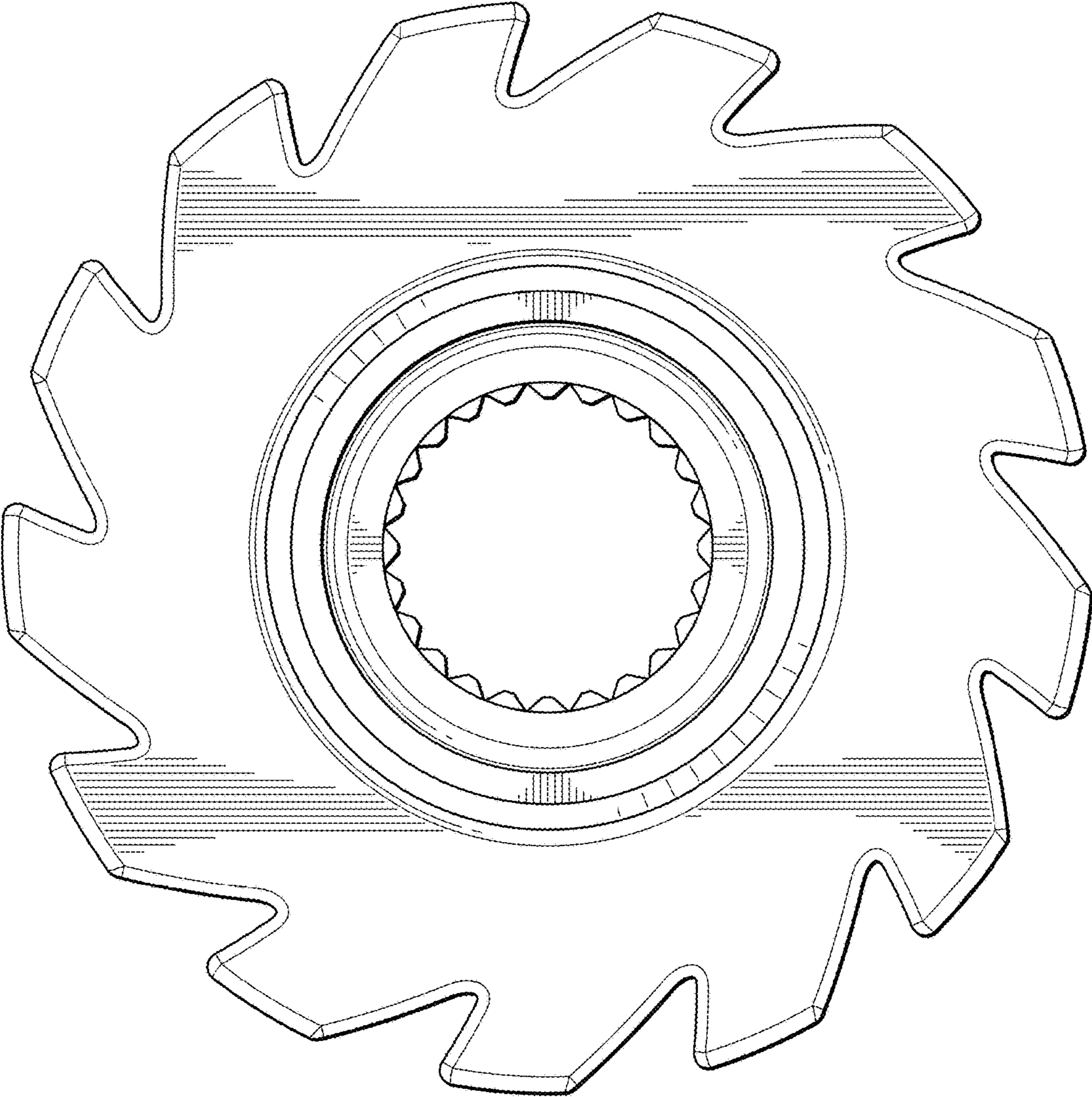

FIG. 7

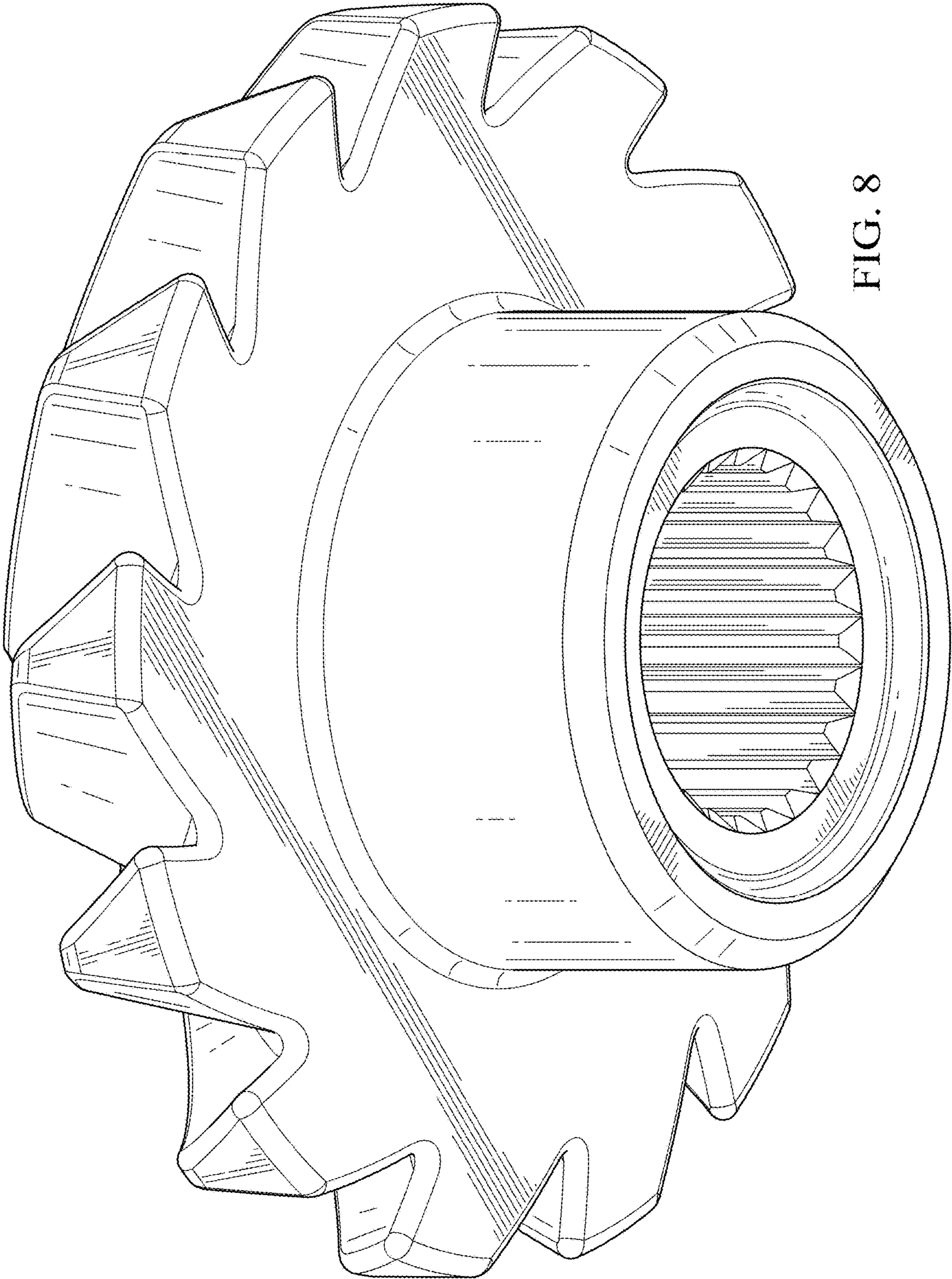

FIG. 8