



US00D845259S

(12) **United States Design Patent**
Won et al.

(10) **Patent No.:** **US D845,259 S**
(45) **Date of Patent:** **** Apr. 9, 2019**

(54) **TELEVISION**

(71) Applicant: **LG ELECTRONICS INC.**, Seoul (KR)

(72) Inventors: **Hyojin Won**, Seoul (KR); **Hyeyoung Hong**, Seoul (KR); **Yongho Lee**, Seoul (KR); **Youngkyoung Kim**, Seoul (KR)

(73) Assignee: **LG ELECTRONICS INC.**, Seoul (KR)

(**) Term: **15 Years**

(21) Appl. No.: **35/504,056**

(22) Filed: **May 25, 2017**

(80) **Hague Agreement Data**

Int. Filing Date: **May 25, 2017**
Int. Reg. No.: **DM/096324**
Int. Reg. Date: **May 25, 2017**
Int. Reg. Pub. Date: **Dec. 1, 2017**

(30) **Foreign Application Priority Data**

Nov. 25, 2016 (KR) 30-2016-0056922

(51) **LOC (11) Cl.** **14-03**

(52) **U.S. Cl.**
USPC **D14/126**

(58) **Field of Classification Search**
USPC D14/125-134, 136, 159, 239, 336, 342, D14/371, 374-377, 440, 448, 450; D21/329, 515, 577, 622
CPC ... G06F 1/1601; G06F 1/1643; H05K 5/0004; H05K 5/0017; H05K 5/02; H05K 5/0217
See application file for complete search history.

(56) **References Cited**

U.S. PATENT DOCUMENTS

D717,756 S * 11/2014 Park D14/126
D722,300 S * 2/2015 Won D14/126

D772,831 S * 11/2016 Han D14/126
D772,832 S * 11/2016 Han D14/126
D772,833 S * 11/2016 Han D14/126
D773,419 S * 12/2016 Han D14/126
D790,493 S * 6/2017 Han D14/126
D791,094 S * 7/2017 Han D14/126
D807,313 S * 1/2018 Kim D14/126
D807,846 S * 1/2018 Kim D14/126
D812,028 S * 3/2018 Kim D14/126
D813,831 S * 3/2018 Han D14/126
D813,832 S * 3/2018 Kim D14/126
D817,905 S * 5/2018 Kim D14/126
D821,342 S * 6/2018 Kim D14/126
D823,822 S * 7/2018 Kim D14/126
D823,823 S * 7/2018 Kim D14/126
D824,352 S * 7/2018 Kim D14/126

* cited by examiner

Primary Examiner — Karen E Kearney
Assistant Examiner — Bao-Yen T Nguyen
(74) *Attorney, Agent, or Firm* — Birch, Stewart, Kolasch & Birch, LLP

(57) **CLAIM**

The ornamental design for a television, as shown and described.

DESCRIPTION

- 1. Television
- 1.1 : Perspective
- 1.2 : Front
- 1.3 : Back
- 1.4 : Left
- 1.5 : Right
- 1.6 : Top
- 1.7 : Bottom
- 1.8 : Enlarged

The broken lines illustrate portions of the television and form no part of the claimed design. The dash-dot broken lines in 1.8 are included to show a partially enlarged view of 1.1 and form no part of the claimed design.

1 Claim, 8 Drawing Sheets

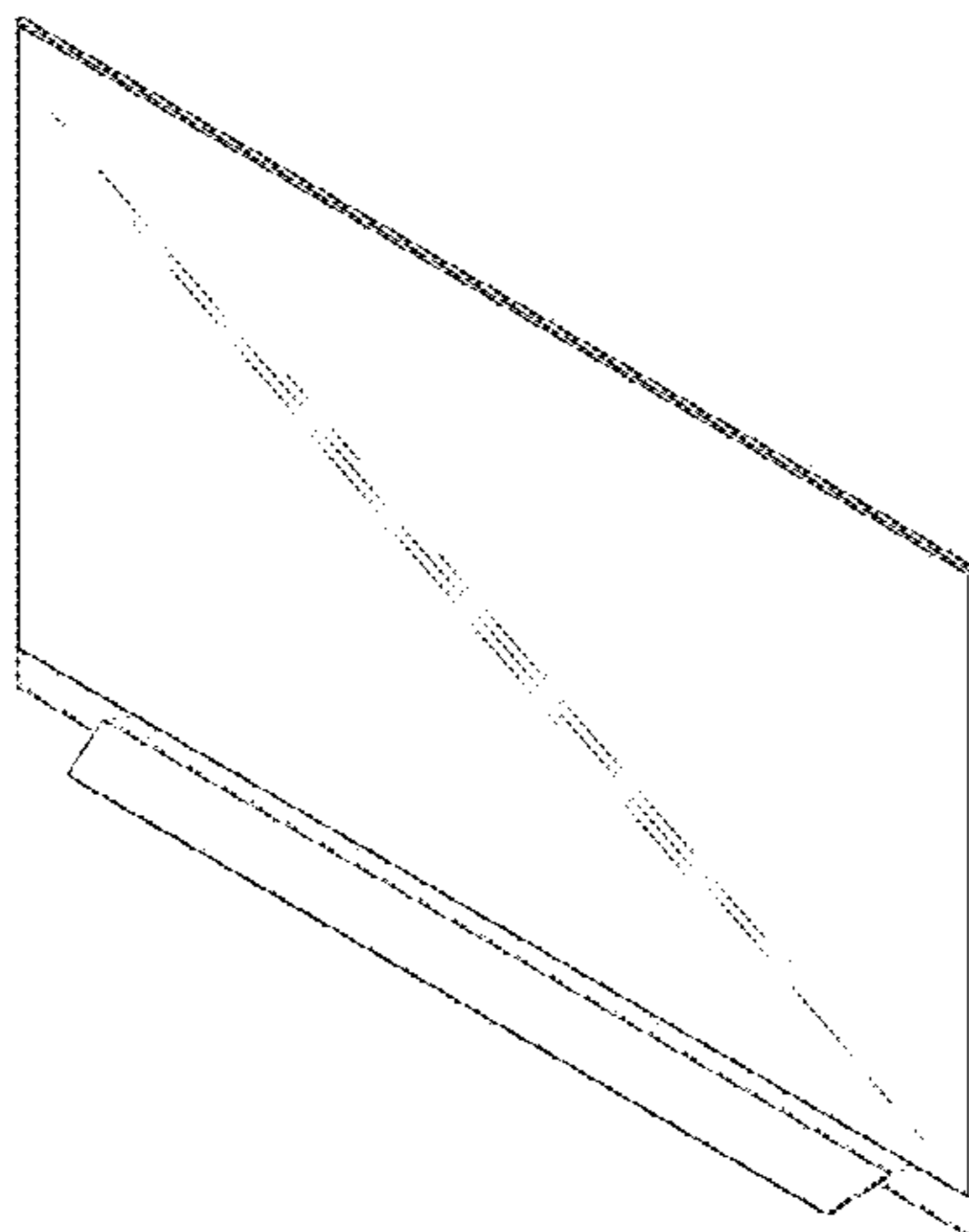

1.1

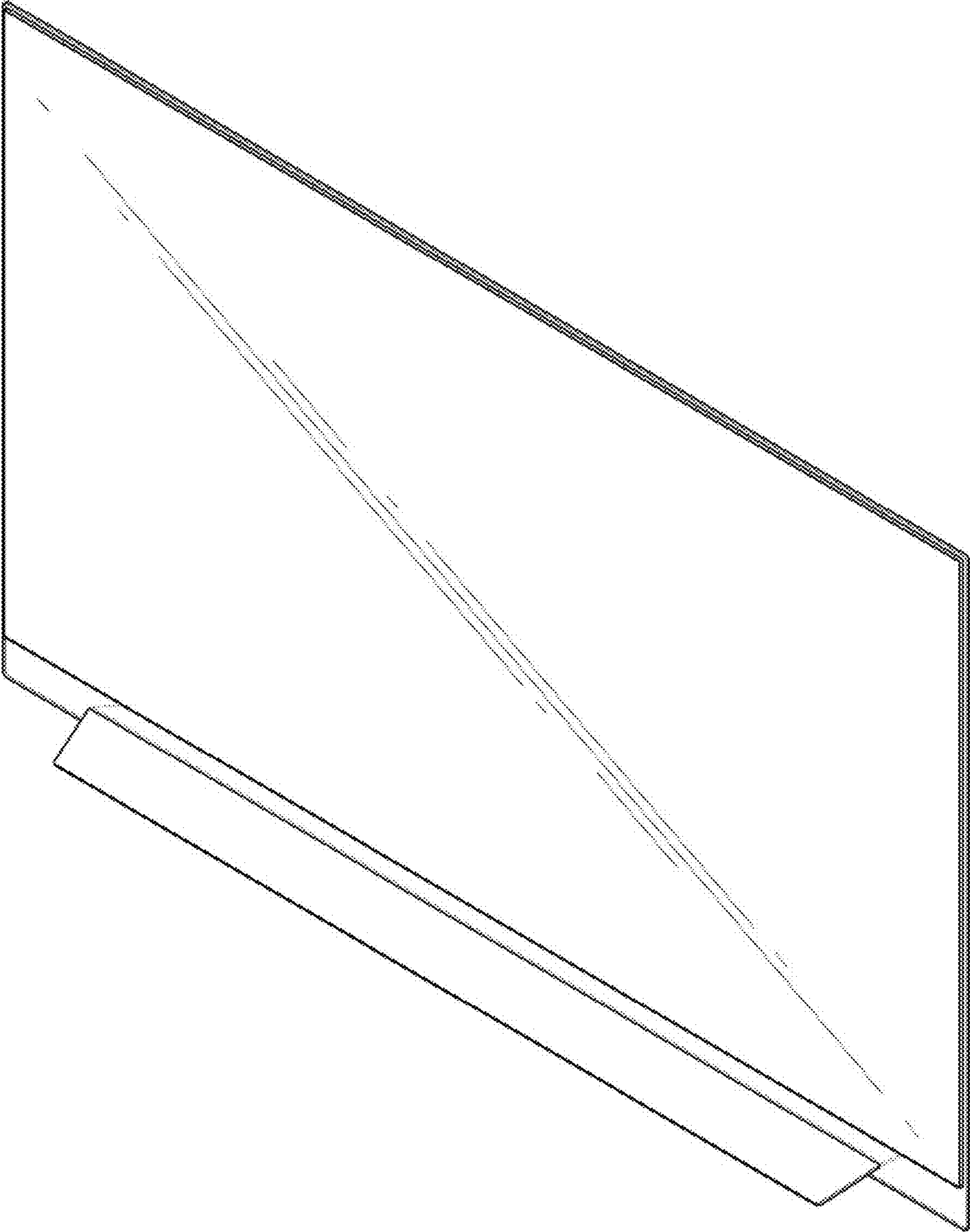

1.2

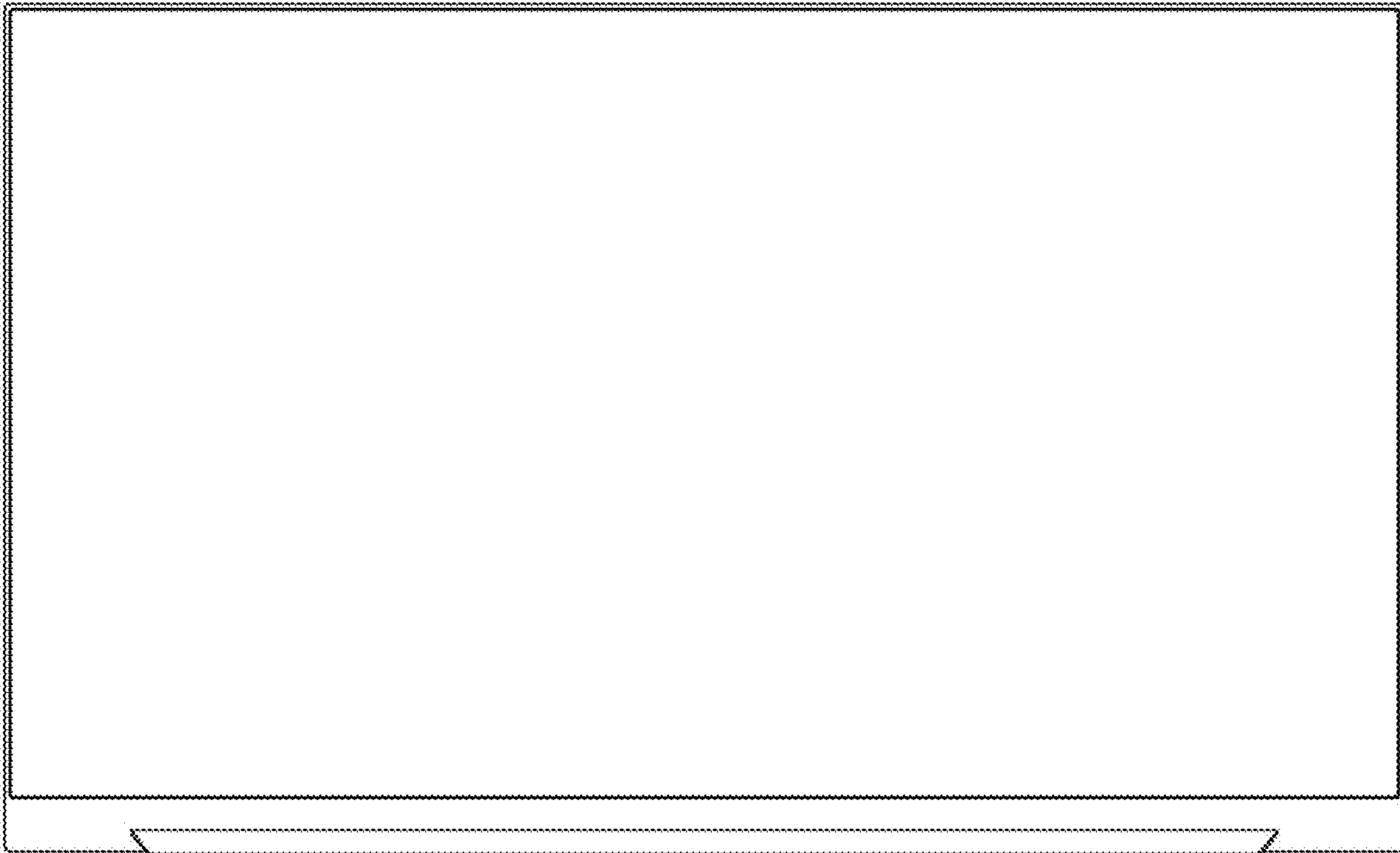

1.3

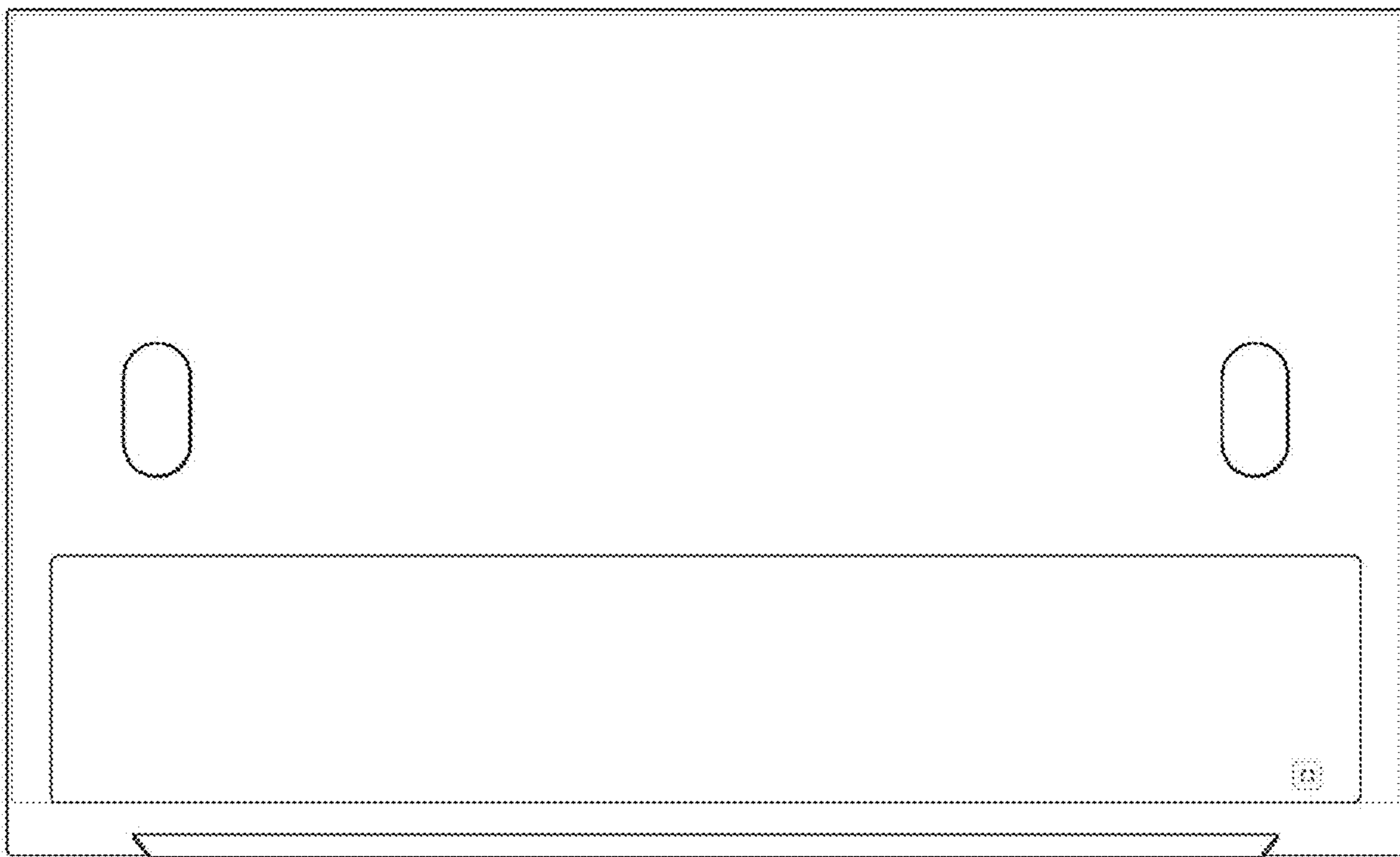

1.4

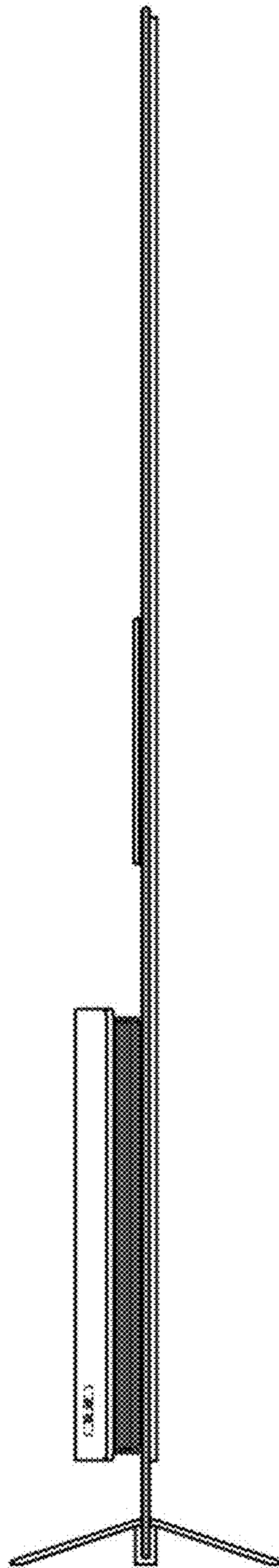

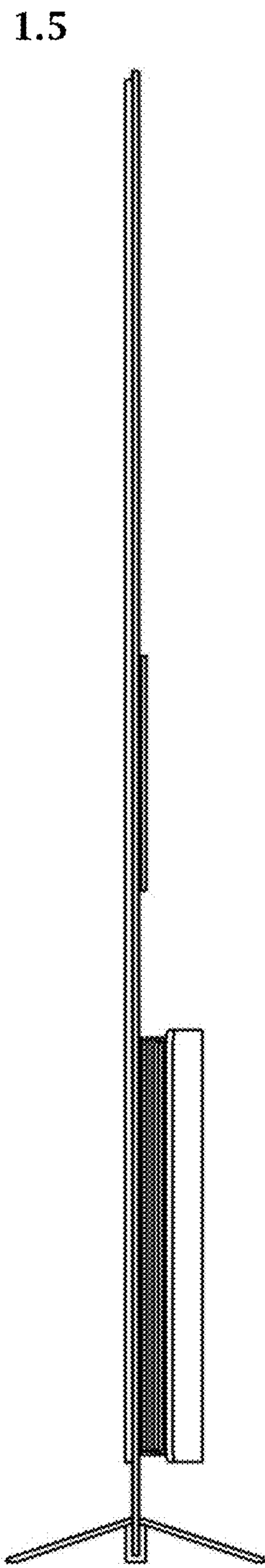

1.6

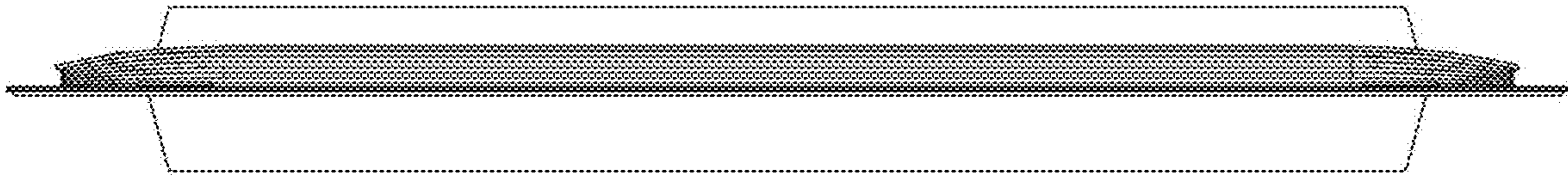

1.7

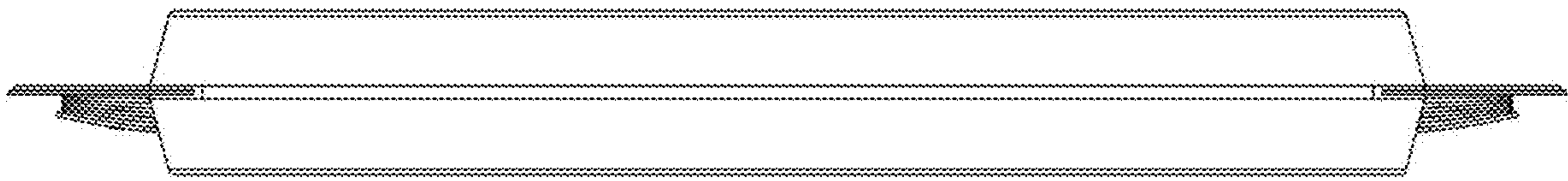

1.8

