



US00D845248S

(12) **United States Design Patent**
Kitagawa

(10) **Patent No.:** **US D845,248 S**
(45) **Date of Patent:** **** Apr. 9, 2019**

(54) **ELECTRIC CONNECTOR**

(71) Applicant: **KYOCERA Corporation**, Kyoto-shi,
Kyoto (JP)

(72) Inventor: **Naoki Kitagawa**, Yokohama (JP)

(73) Assignee: **KYOCERA Corporation**, Kyoto-shi,
Kyoto (JP)

(**) Term: **15 Years**

(21) Appl. No.: **29/612,272**

(22) Filed: **Jul. 31, 2017**

(30) **Foreign Application Priority Data**

Feb. 2, 2017 (JP) 2017-001880

(51) **LOC (11) Cl.** **13-03**

(52) **U.S. Cl.**
USPC **D13/147**

(58) **Field of Classification Search**
USPC D13/118, 123, 133, 146, 147, 154, 173,
D13/184, 199

(Continued)

(56) **References Cited**

U.S. PATENT DOCUMENTS

6,352,442 B1 * 3/2002 Kudo H01R 12/88
439/260

D472,219 S * 3/2003 Miura D13/147

(Continued)

FOREIGN PATENT DOCUMENTS

JP 4526040 B2 8/2010

Primary Examiner — Angela J Lee

Assistant Examiner — Shawn T Gingrich

(74) *Attorney, Agent, or Firm* — Kenja IP Law PC

(57) **CLAIM**

The ornamental design for an electric connector, as shown and described.

DESCRIPTION

FIG. 1 is a front, right, and top perspective view of an electric connector showing my new design;
FIG. 2 is a rear, left, and top perspective view thereof,
FIG. 3 is a rear, left, and bottom perspective view thereof,
FIG. 4 is a front view thereof;
FIG. 5 is a top view thereof;
FIG. 6 is a right side view thereof;
FIG. 7 is a rear view thereof;
FIG. 8 is a bottom view thereof;
FIG. 9 is a section view thereof taken along the line 9-9 in FIG. 4;
FIG. 10 is a section view thereof taken along the line 10-10 of FIG. 4;
FIG. 11 is a front perspective view thereof, looking in the direction of arrow 11 of FIG. 6;
FIG. 12 is a rear perspective view thereof; looking in the direction of arrow 12 of FIG. 6;
FIG. 13 is an enlarged view of a portion thereof taken in FIG. 11;
FIG. 14 is an enlarged view of a portion thereof taken in FIG. 12;
FIG. 15 is an enlarged view of a portion thereof taken in FIG. 1;
FIG. 16 is an enlarged view of a portion thereof taken in FIG. 1;
FIG. 17 is an enlarged view of a portion thereof taken in FIG. 2; and,
FIG. 18 is an enlarged view of a portion thereof taken in FIG. 3.

The dash-dash broken lines shown in the drawings are portions of the article that form no part of the claimed design. The dash-dot-dash broken lines are used to show the boundary between unclaimed and claimed subject matter, and thus form no part of the claimed design.

1 Claim, 18 Drawing Sheets

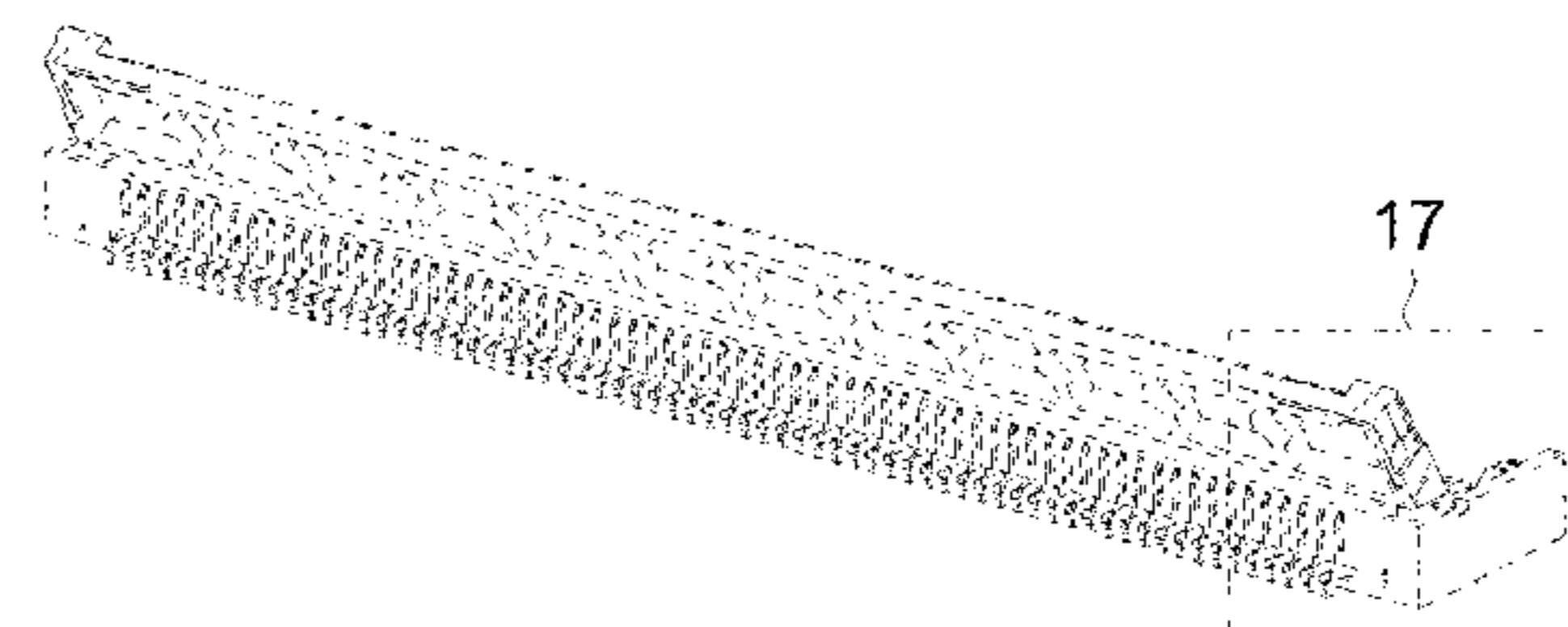
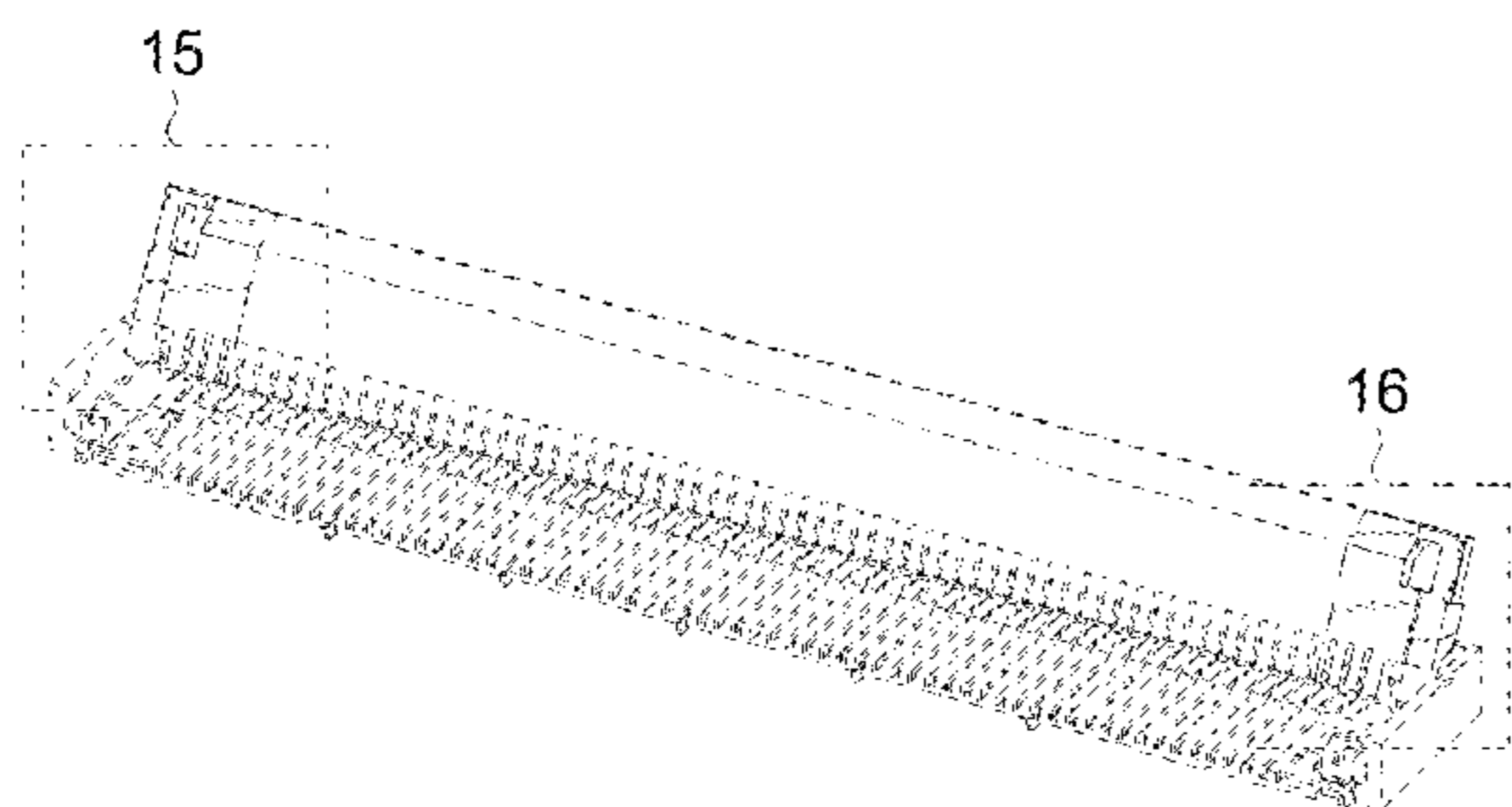

(58) **Field of Classification Search**

CPC H01R 12/00; H01R 12/52; H01R 12/70;
 H01R 12/71; H01R 13/22; H01R 13/28;
 H01R 13/405; H01R 13/631; H01R
 24/62; H01R 4/24; H01R 12/68; H01R
 12/79; H01R 12/88; H01R 13/15; H01R
 13/115; H01R 13/44; H01R 13/62; H05K
 1/00

See application file for complete search history.

(56) **References Cited**

U.S. PATENT DOCUMENTS

6,997,729 B2 * 2/2006 Sunaga H01R 12/79
 439/260
 7,134,891 B2 * 11/2006 Kayama H01R 12/88
 439/260
 D533,507 S * 12/2006 Suzuki D13/147
 D534,127 S * 12/2006 Suzuki D13/147
 D534,128 S * 12/2006 Suzuki D13/147

D539,748 S * 4/2007 Suzuki D13/147
 D582,853 S * 12/2008 Peng D13/147
 D669,860 S * 10/2012 Sasaki D13/147
 D673,505 S * 1/2013 Matoba D13/147
 D704,143 S * 5/2014 Yoshisuji D13/147
 D753,603 S * 4/2016 Yokoo D13/147
 D755,725 S * 5/2016 Honda D13/147
 9,455,513 B2 * 9/2016 Yokoo H01R 12/88
 9,553,384 B2 * 1/2017 Asanuma H01R 12/778
 D800,070 S * 10/2017 Manba D13/147
 2006/0084311 A1 * 4/2006 Suzuki H01R 12/771
 439/260
 2008/0020616 A1 * 1/2008 Murakami H01R 12/592
 439/164
 2009/0221178 A1 * 9/2009 Hirata H01R 12/88
 439/497
 2010/0261375 A1 * 10/2010 Wang H01R 12/88
 439/492
 2017/0331211 A1 * 11/2017 Nakajima H01R 12/88
 2018/0166816 A1 * 6/2018 Takemoto H01R 12/79

* cited by examiner

FIG. 1

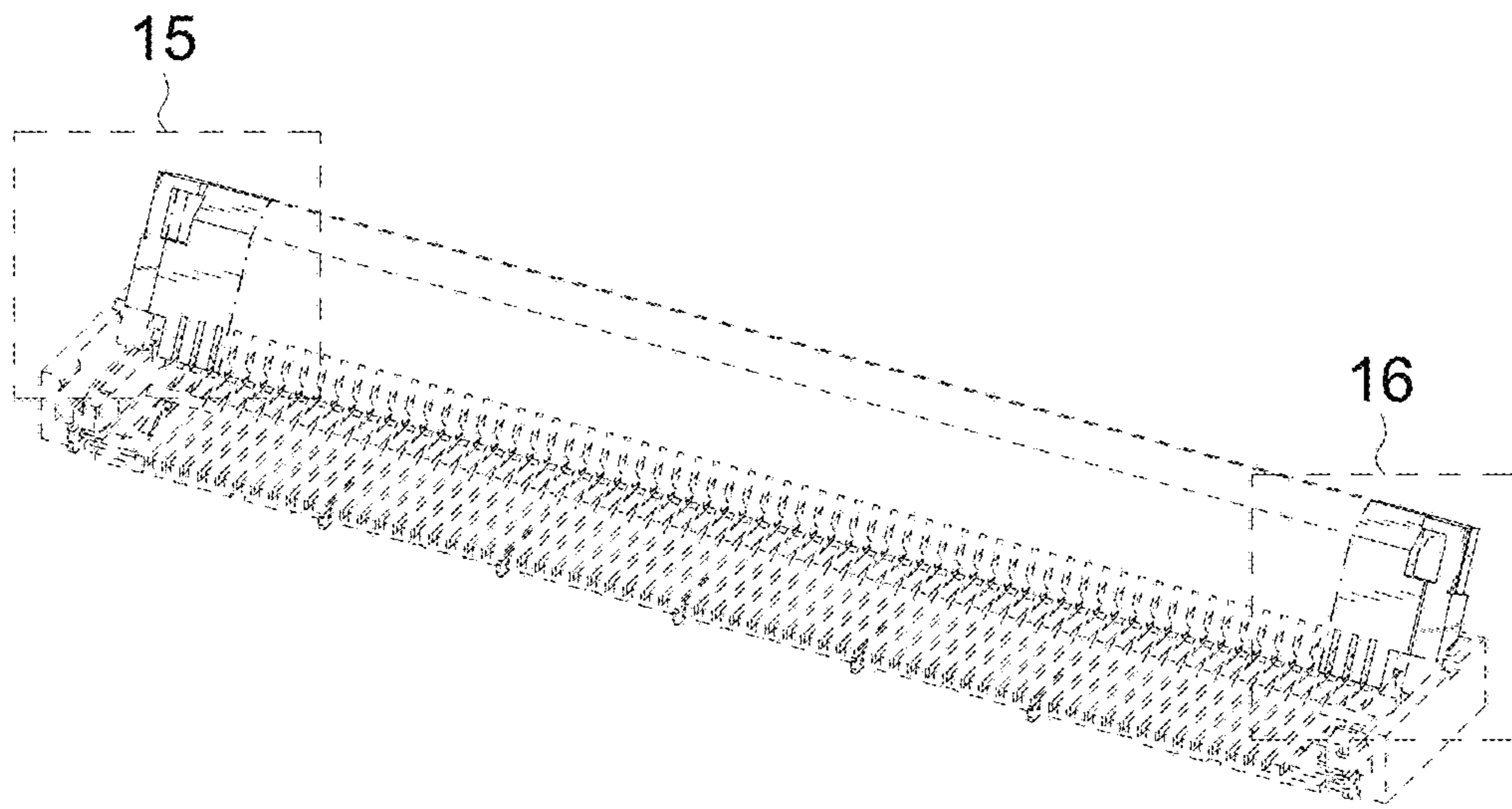

FIG. 2

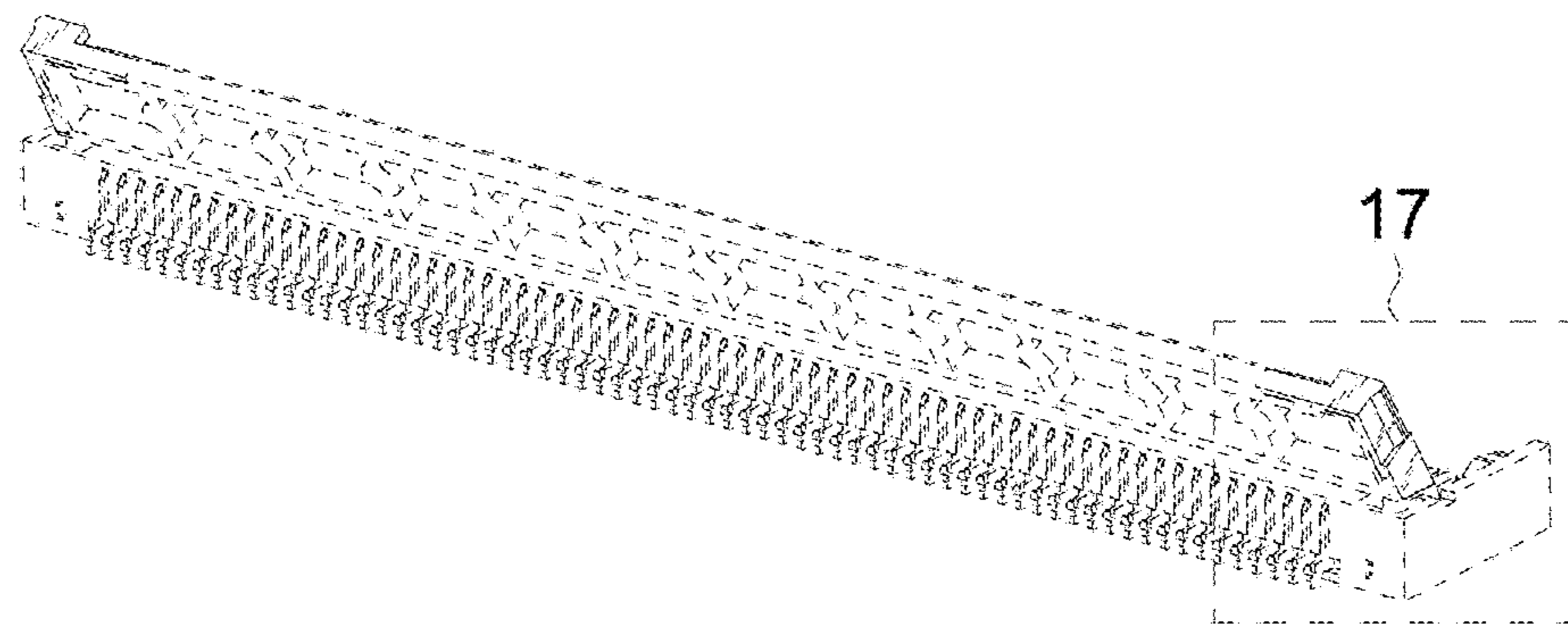

FIG. 3

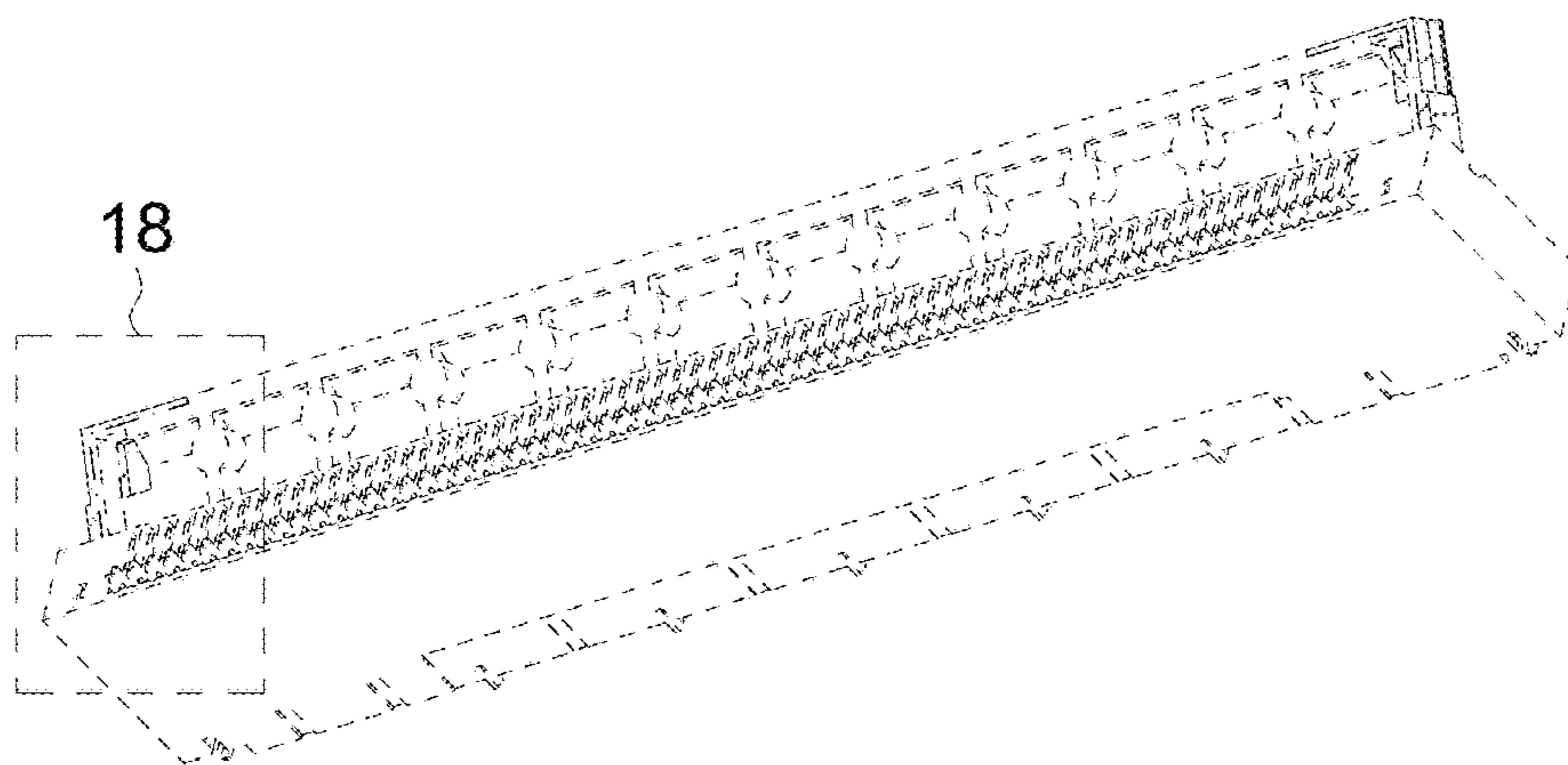

FIG. 4

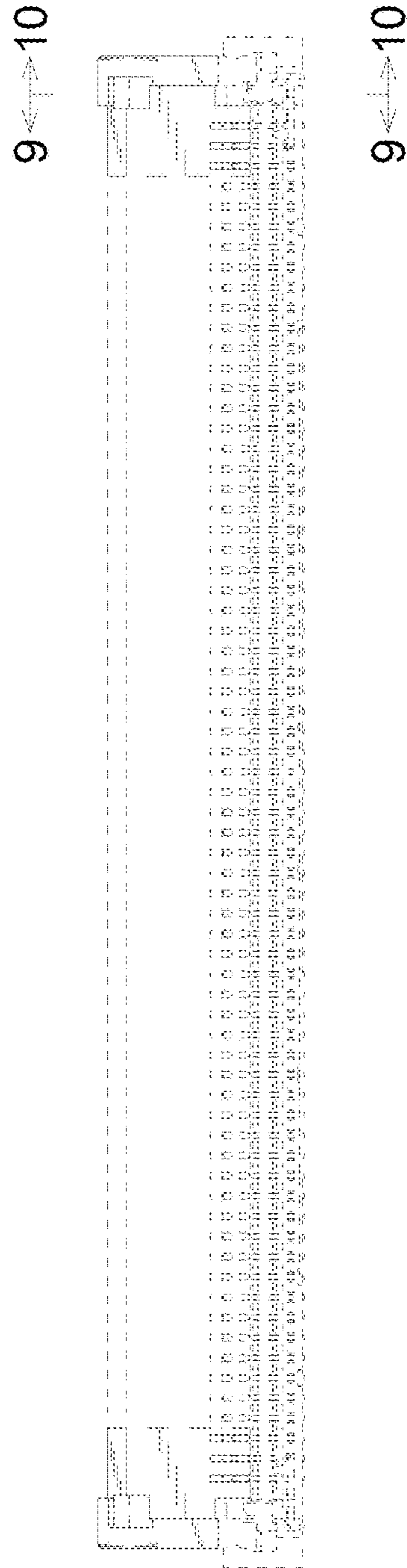

FIG. 5

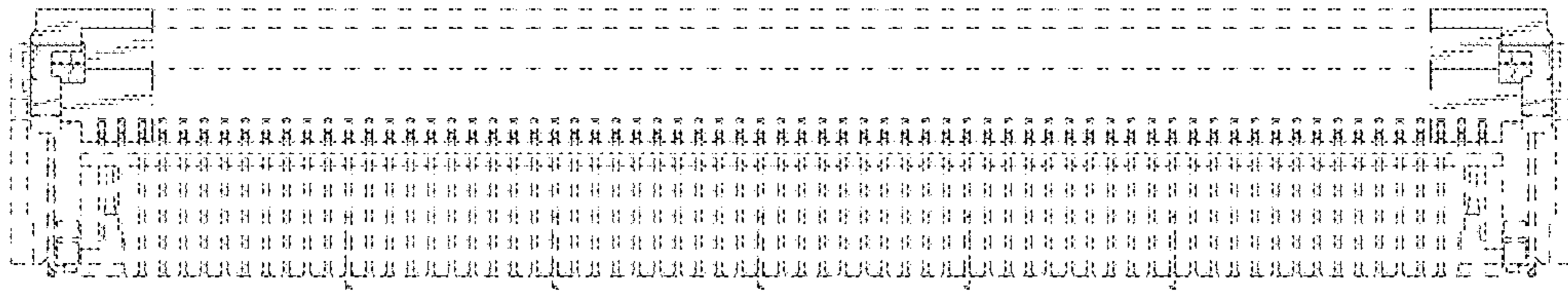

FIG. 6

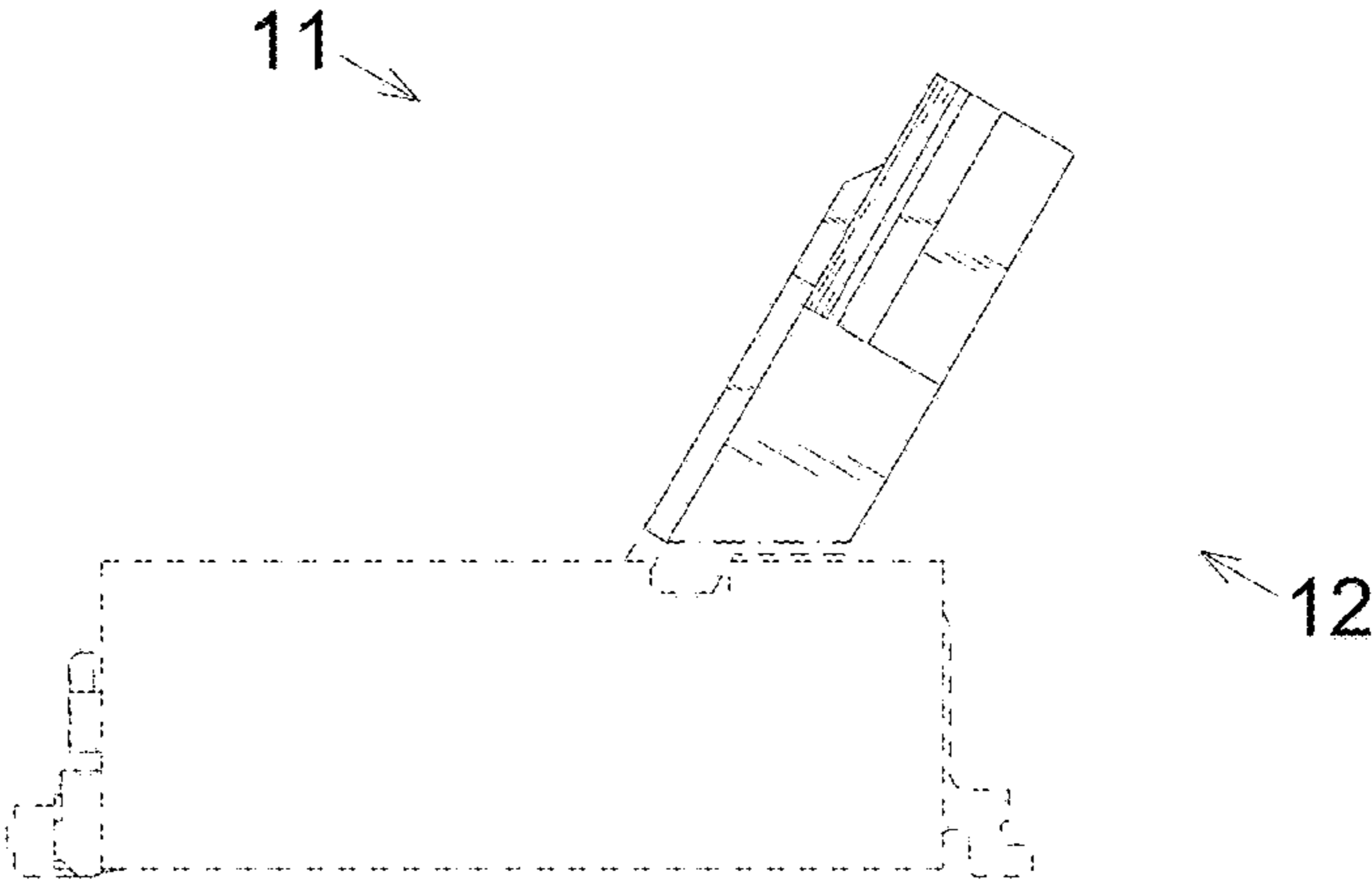

FIG. 7

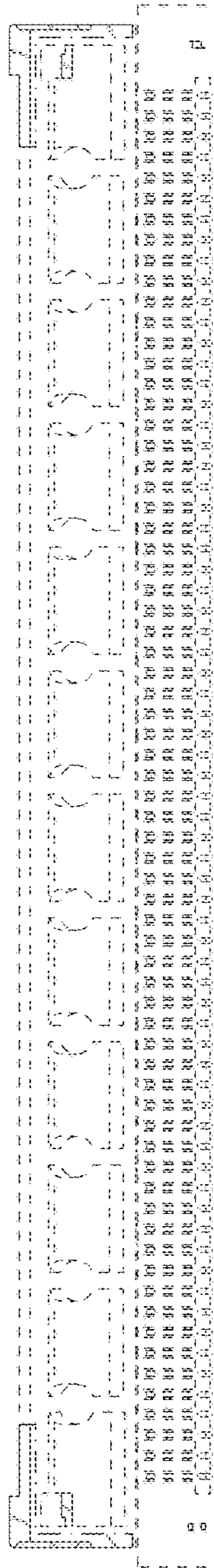

FIG. 8

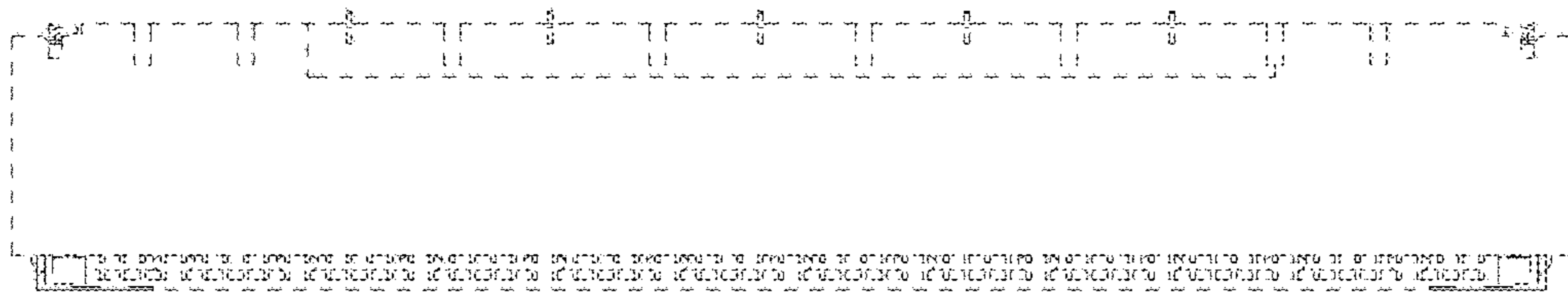

FIG. 9

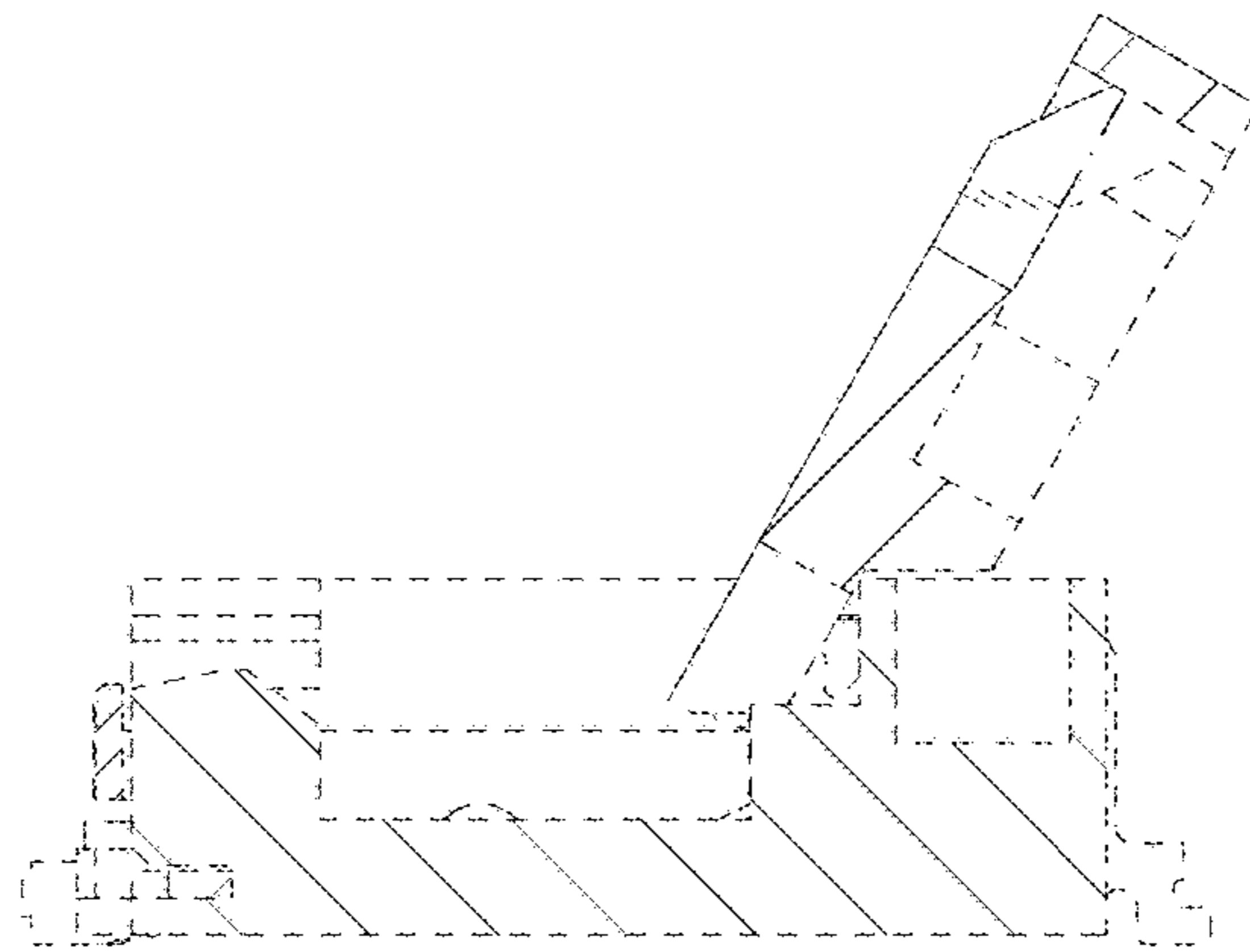

FIG. 10

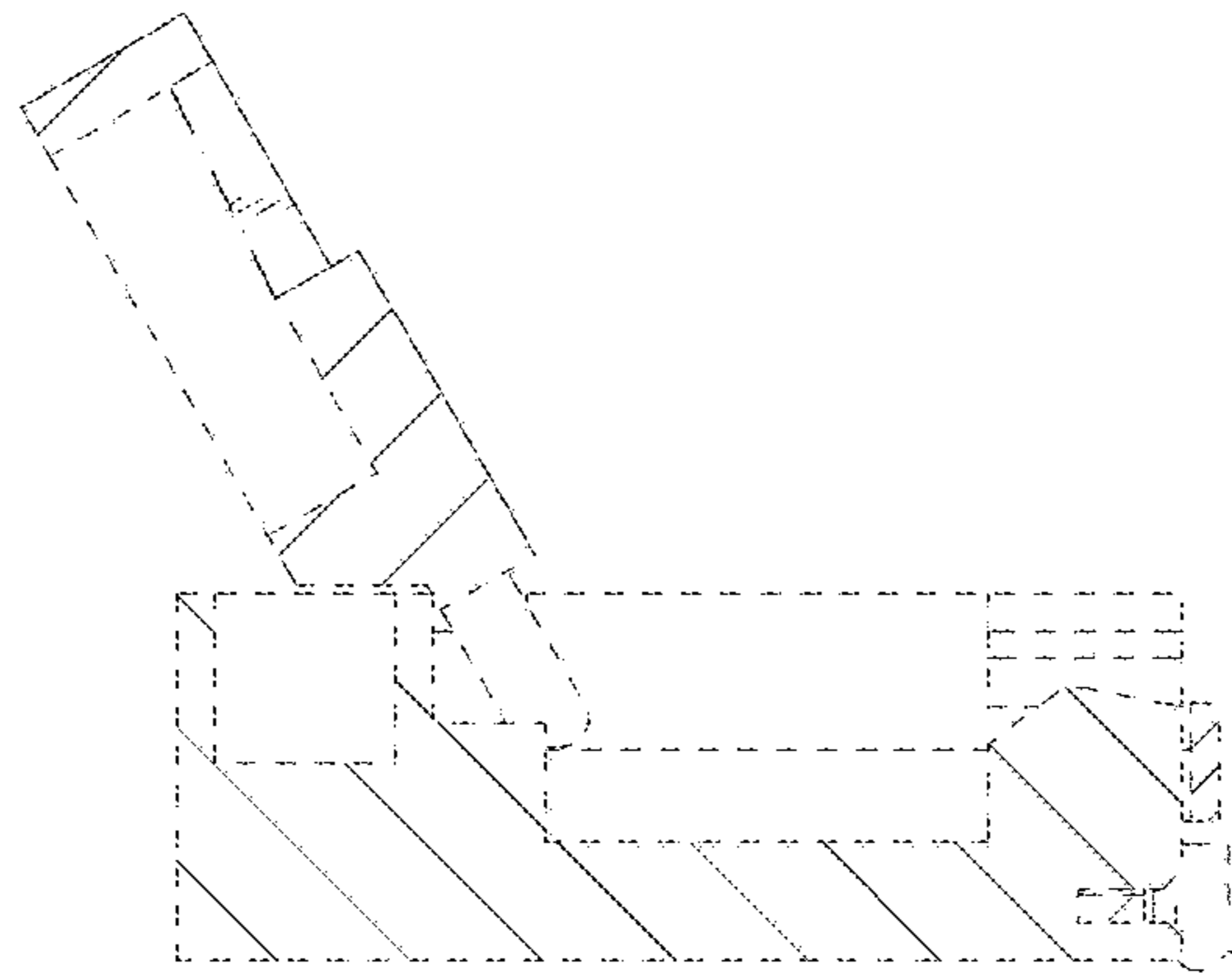

FIG. 11

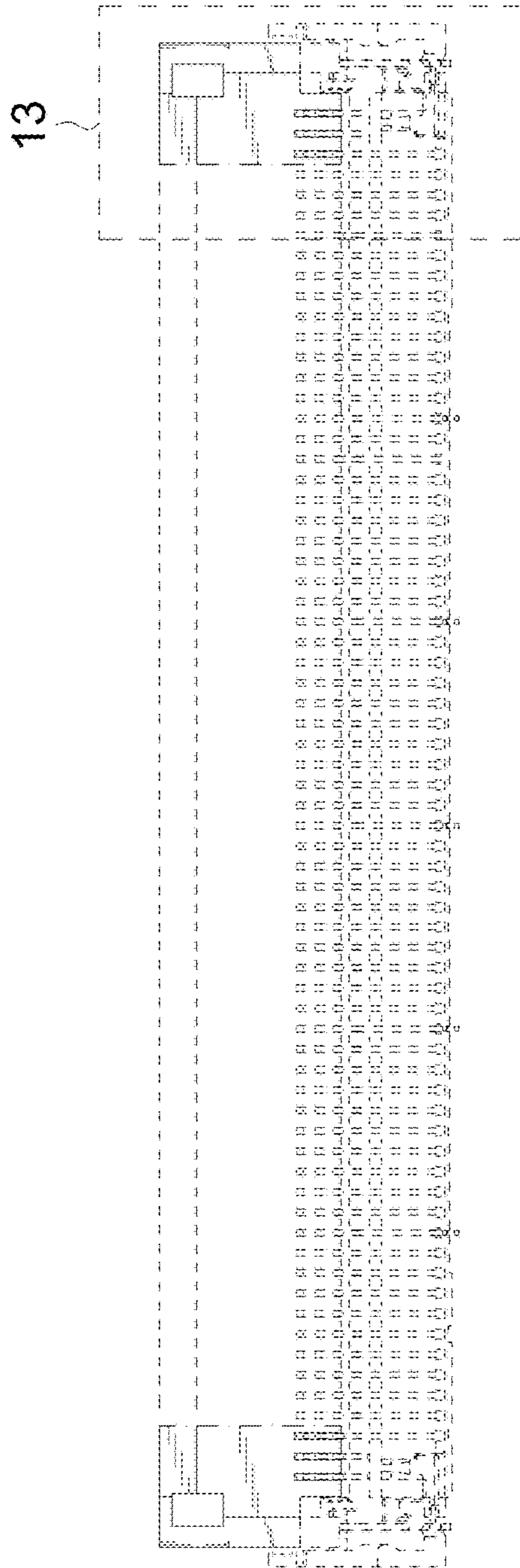

FIG. 12

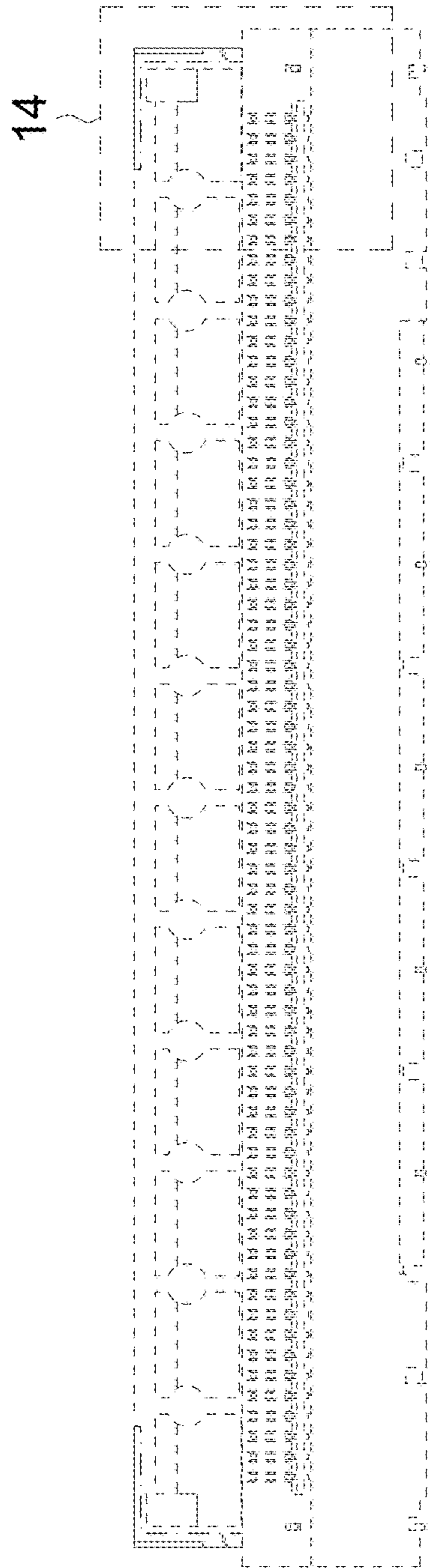

FIG. 13

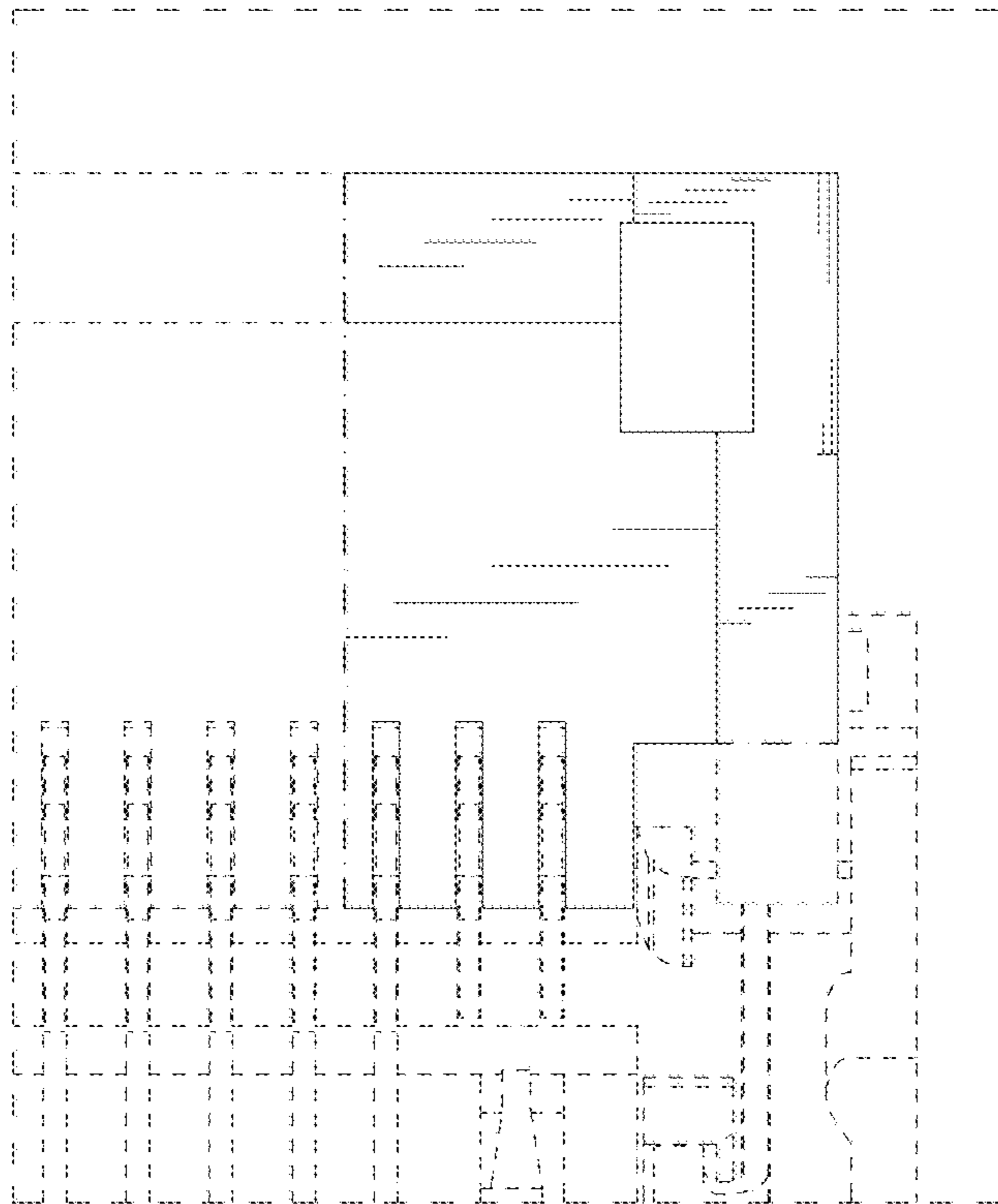

FIG. 14

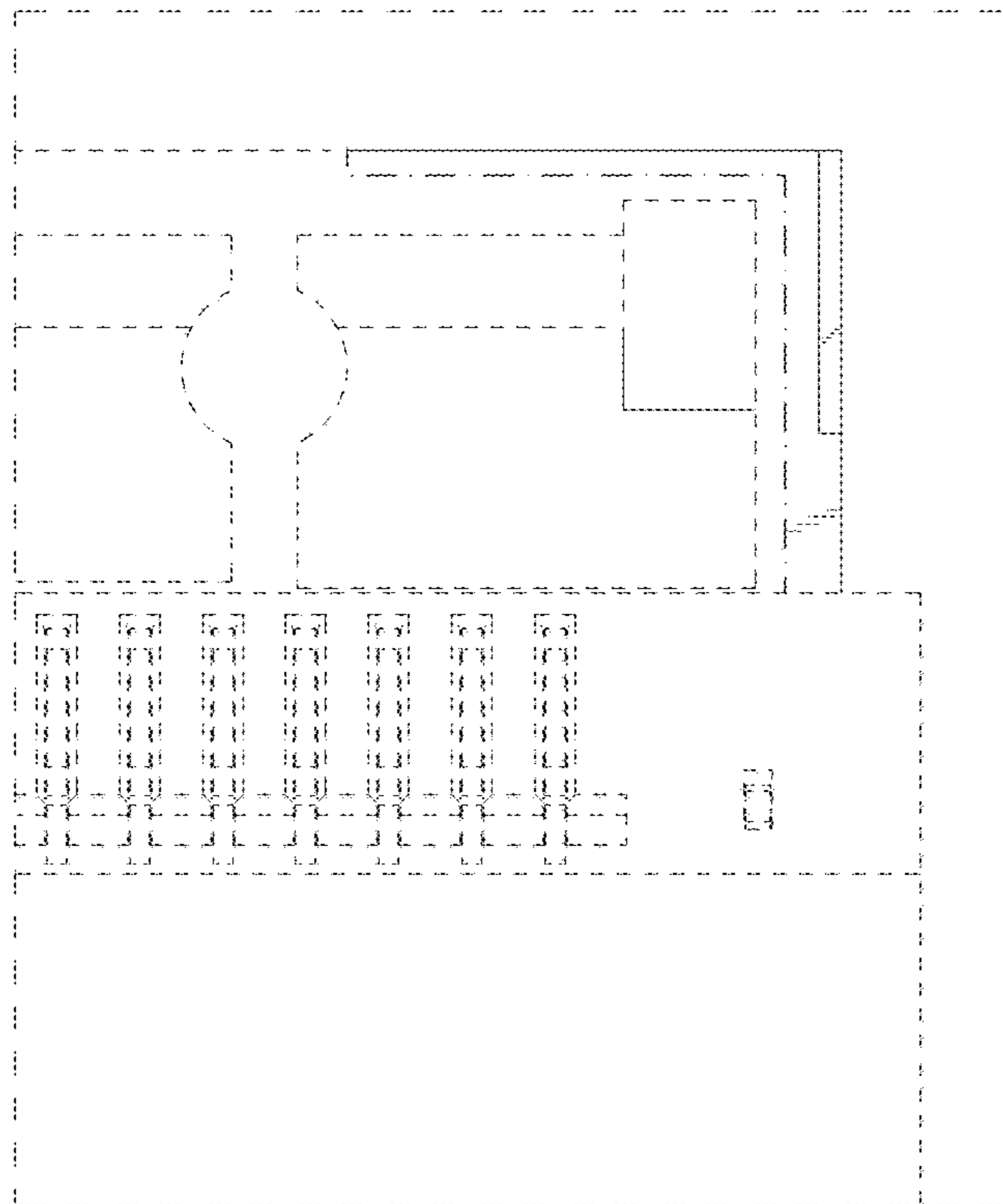

FIG. 15

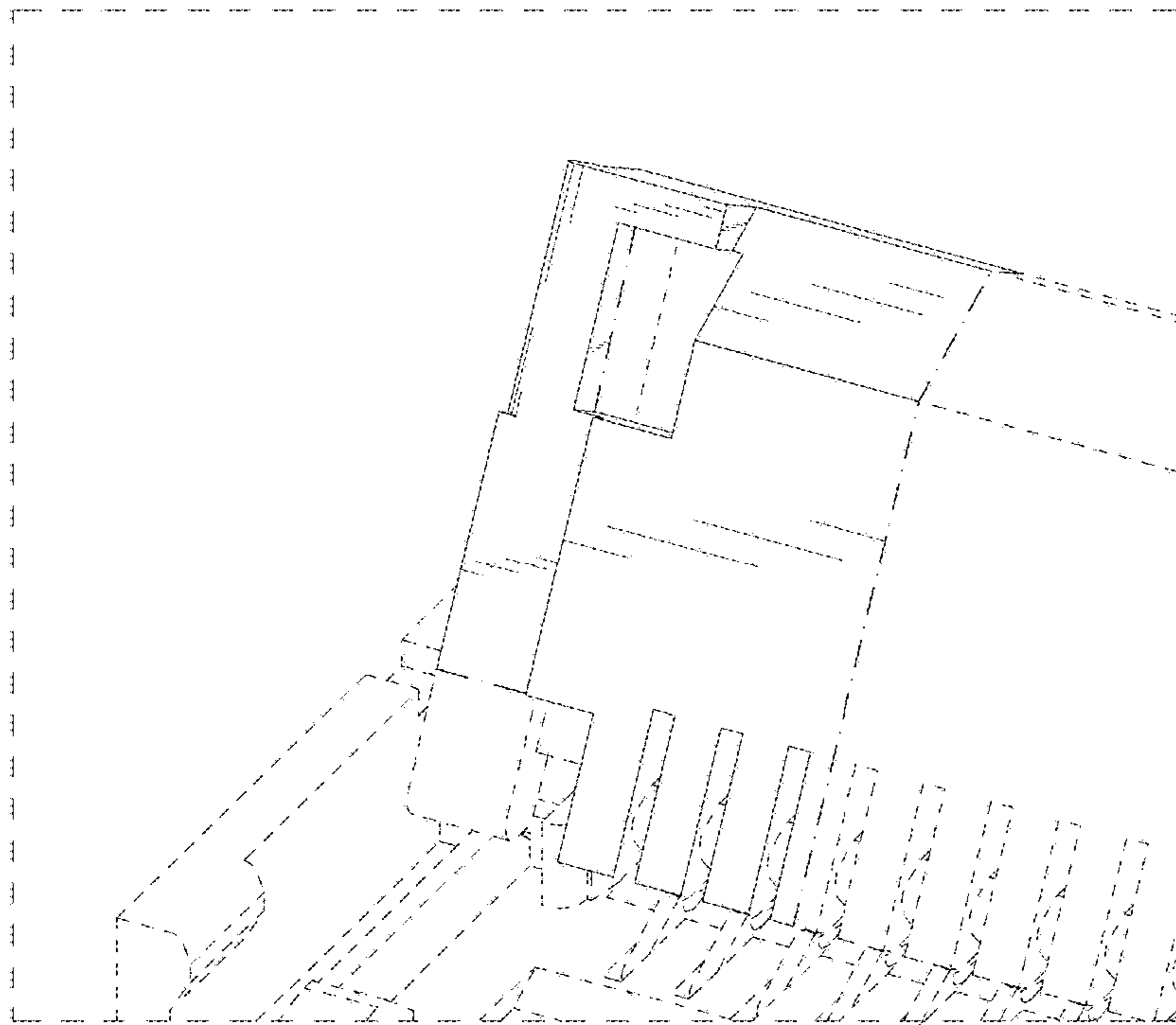

FIG. 16

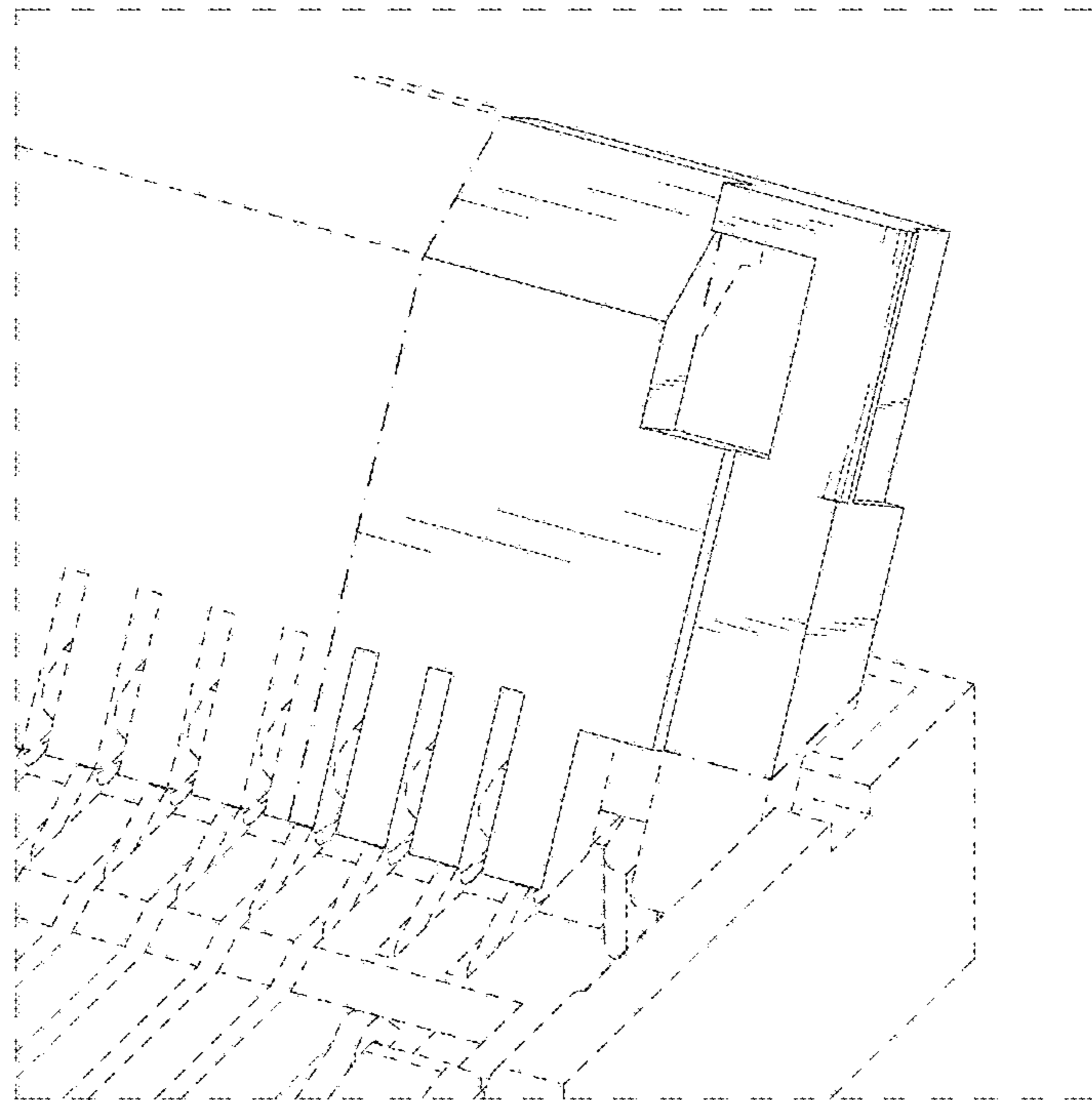

FIG. 17

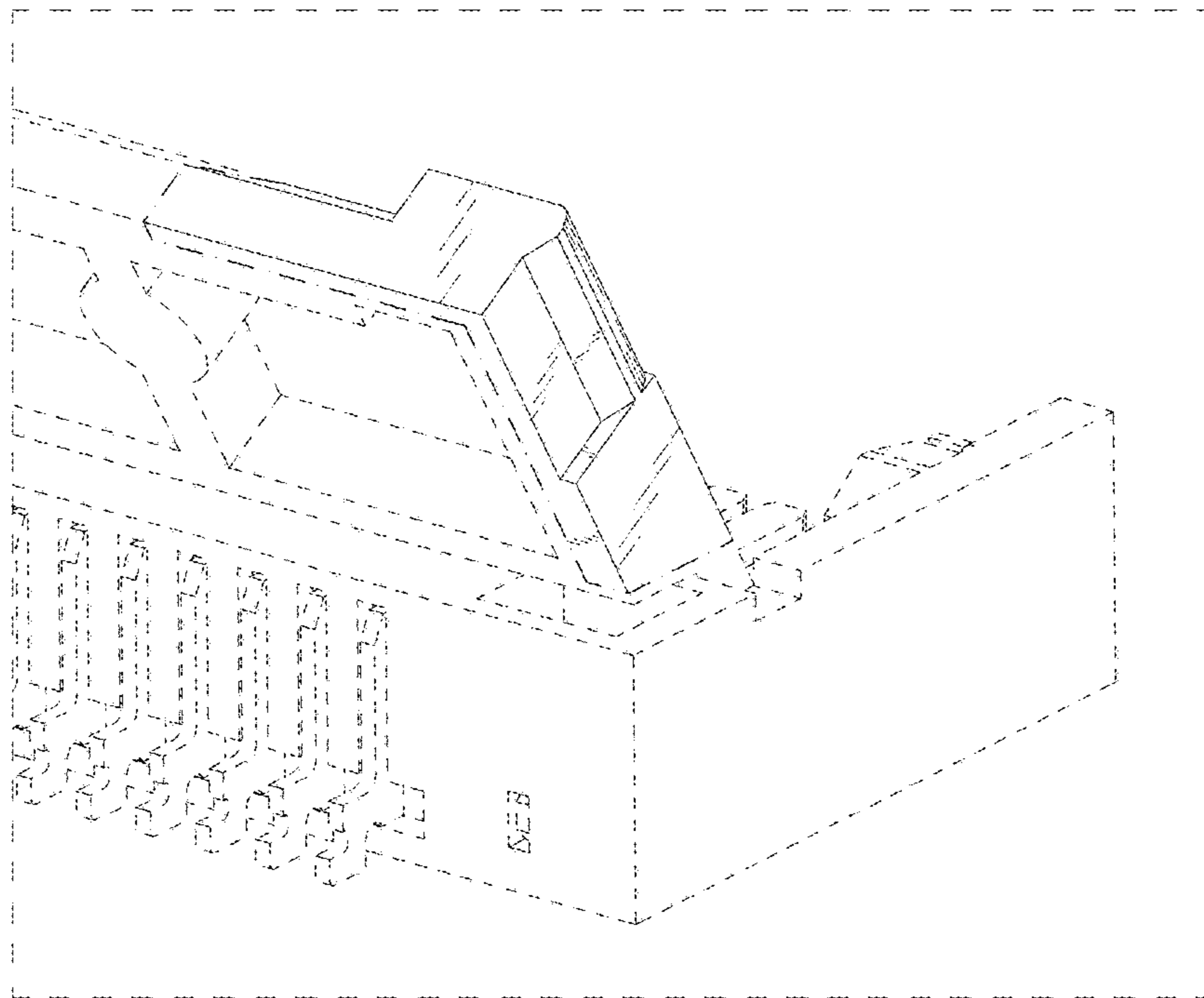

FIG. 18

