



US00D845136S

(12) **United States Design Patent**
Mateus et al.

(10) **Patent No.:** **US D845,136 S**
(45) **Date of Patent:** **** Apr. 9, 2019**

- (54) **ENSEMBLE OF CONTAINER AND LID**
- (71) Applicant: **Natura Cosméticos S.A.**, São Paulo (BR)
- (72) Inventors: **Alessandra de Lourdes Mateus**, Cajamar (BR); **Damaris Maggiotto**, Cajamar (BR); **Vinicius Crepaldi**, Cajamar (BR); **Gustavo Senna Chelles**, São Paulo (BR); **Marcio Fernando Fernandes Mota**, São Paulo (BR); **Luca Bacchiocchi**, São Paulo (BR); **Cristiane Inoue Cardoso da Silva**, São Paulo (BR)

D578,891 S *	10/2008	Canamasas Puigbo	D9/500
D588,011 S *	3/2009	Shimizu	D9/454
D595,578 S *	7/2009	Del Tedesco Zamberlan	D28/76
D621,708 S *	8/2010	Thomas	D9/500
D631,608 S *	1/2011	Pires	D28/82
D685,263 S *	7/2013	Danenberg	D9/500
D711,239 S *	8/2014	Julier	D9/549
9,101,192 B2 *	8/2015	Martins	A45D 33/006
D746,627 S *	1/2016	Puigbo	D9/503
9,375,071 B1 *	6/2016	Wang	A45D 40/221
D769,719 S *	10/2016	Lebon	D9/500
2009/0272399 A1 *	11/2009	Kim	A45D 33/008 132/293
2010/0307521 A1 *	12/2010	Pires	A45D 33/006 132/200

(Continued)

- (73) Assignee: **NATURA COSMÉTICOS S.A.**, São Paulo—SP (BR)

Primary Examiner — Ian Simmons
Assistant Examiner — Keith Frank

- (**) Term: **15 Years**

(74) *Attorney, Agent, or Firm* — B. Aaron Schulman, Esq.; Stites & Harbison, PLLC

- (21) Appl. No.: **29/539,115**

(57) **CLAIM**

- (22) Filed: **Sep. 10, 2015**

The ornamental design for a container with lid, as shown and described.

- (51) **LOC (11) Cl.** **09-01**

DESCRIPTION

- (52) **U.S. Cl.**

USPC **D9/529**; D9/575; D28/91

- (58) **Field of Classification Search**

USPC D9/414, 416, 420, 428, 435, 454, 516, D9/529, 549, 575, 715, 716; D28/4, 8, D28/73, 76, 78, 82, 88, 91

CPC A45D 33/006; A45D 33/003; A45D 40/0068; A45D 40/00; B65D 43/00; B65D 43/02; B65D 43/162; B65D 1/10; B65D 2543/00435; B65D 2101/0023

See application file for complete search history.

FIG. 1 is a perspective view of a lid portion of the container with lid of FIG. 5 showing our new design.
 FIG. 2 is a left side elevation view thereof.
 FIG. 3 is a front elevation view thereof.
 FIG. 4 is a top plan view thereof.
 FIG. 5 is a top perspective view of a container with the lid of FIG. 1.
 FIG. 6 is a left side perspective view thereof.
 FIG. 7 is a rear elevation view thereof.
 FIG. 8 is a front elevation view thereof; and,
 FIG. 9 is a top plan view thereof.
 The broken lines in FIGS. 6-8 are included for the purpose of illustrating a portion of the container with lid that forms no part of the claimed design.

- (56) **References Cited**

U.S. PATENT DOCUMENTS

D424,749 S *	5/2000	Zalzal	D28/76
D467,805 S *	12/2002	Restrepo	D9/500
D577,290 S *	9/2008	Moretti	D9/500

1 Claim, 6 Drawing Sheets

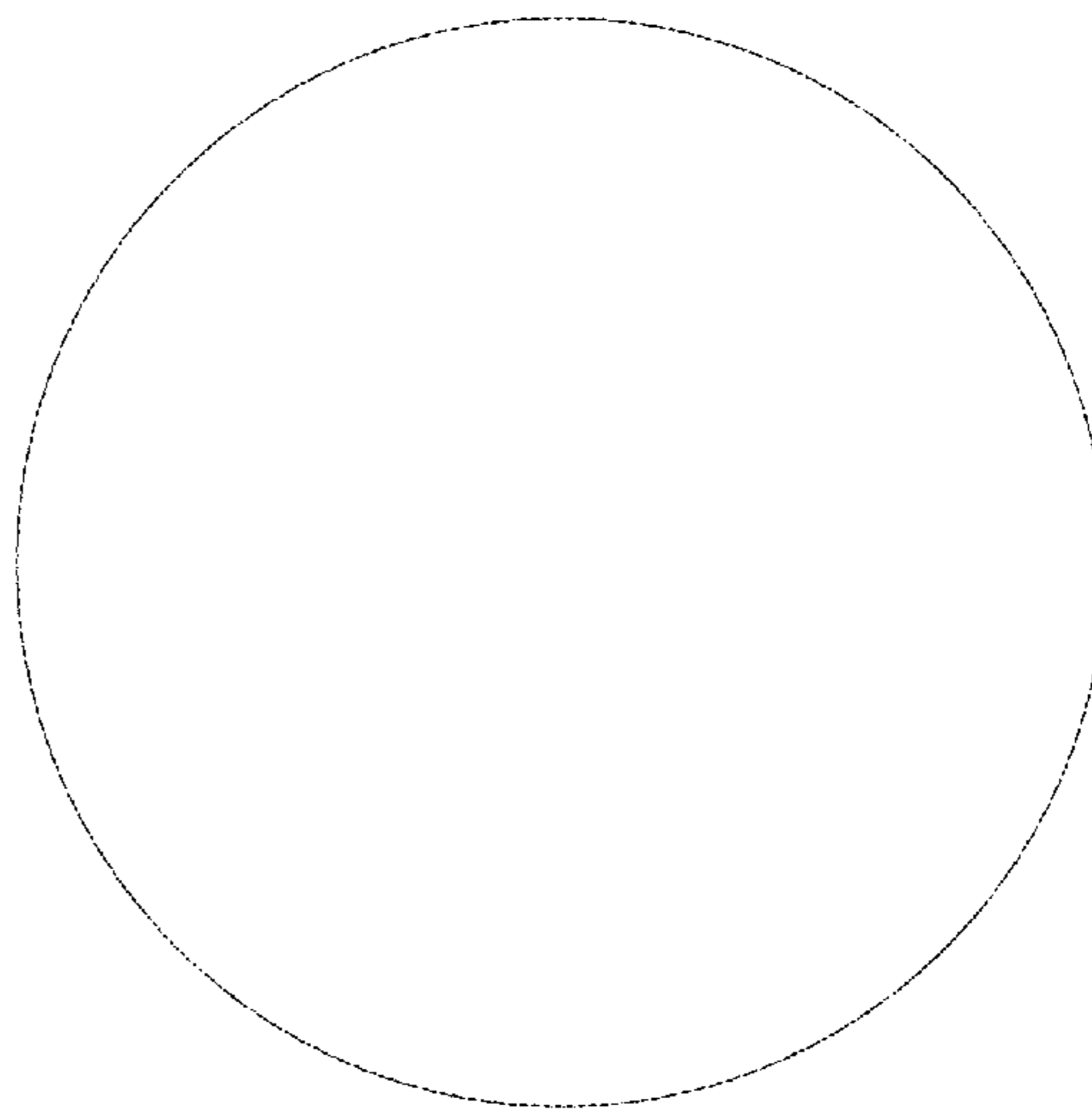
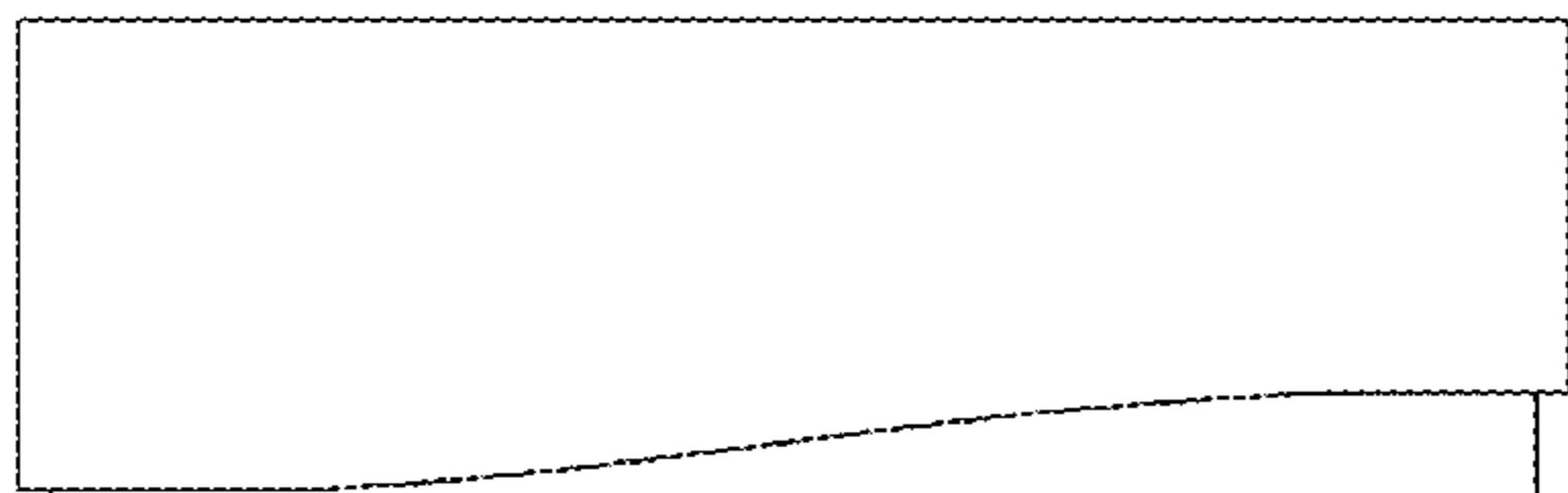

(56)

References Cited

U.S. PATENT DOCUMENTS

2015/0122697 A1* 5/2015 Shen A45D 33/00
206/581
2015/0230583 A1* 8/2015 Maelstaf A45D 40/0068
220/23.87
2016/0207674 A1* 7/2016 Brion B65D 51/20
2016/0235184 A1* 8/2016 Lee A45D 33/006
2016/0262523 A1* 9/2016 Kim A45D 40/00
2016/0280426 A1* 9/2016 Kim A45D 40/0068
2016/0376077 A1* 12/2016 Schandl B65D 45/22
220/203.05
2017/0086560 A1* 3/2017 Pires A45D 33/32
2017/0107027 A1* 4/2017 Sangiovanni B65D 51/20

* cited by examiner

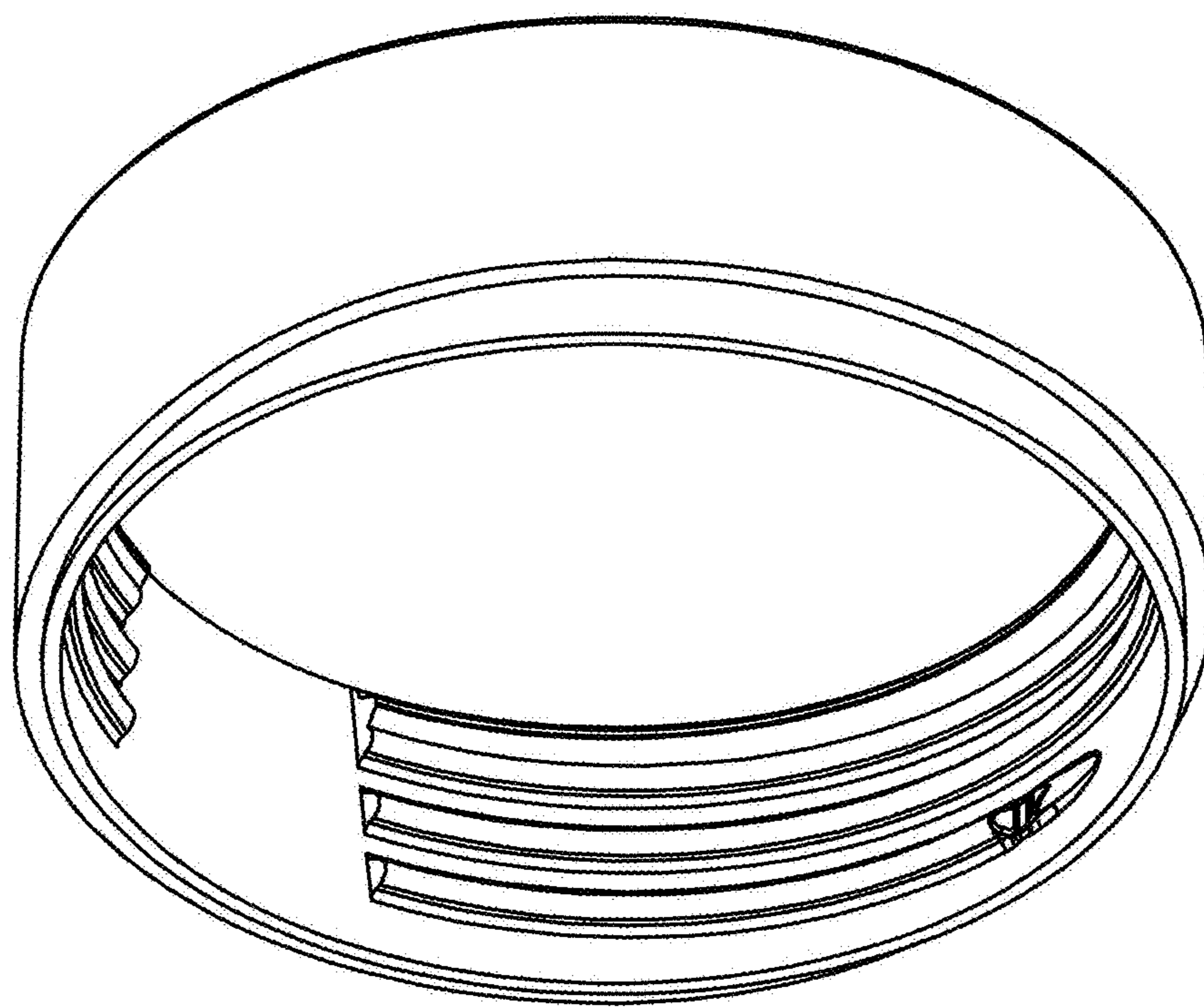

FIG. 1

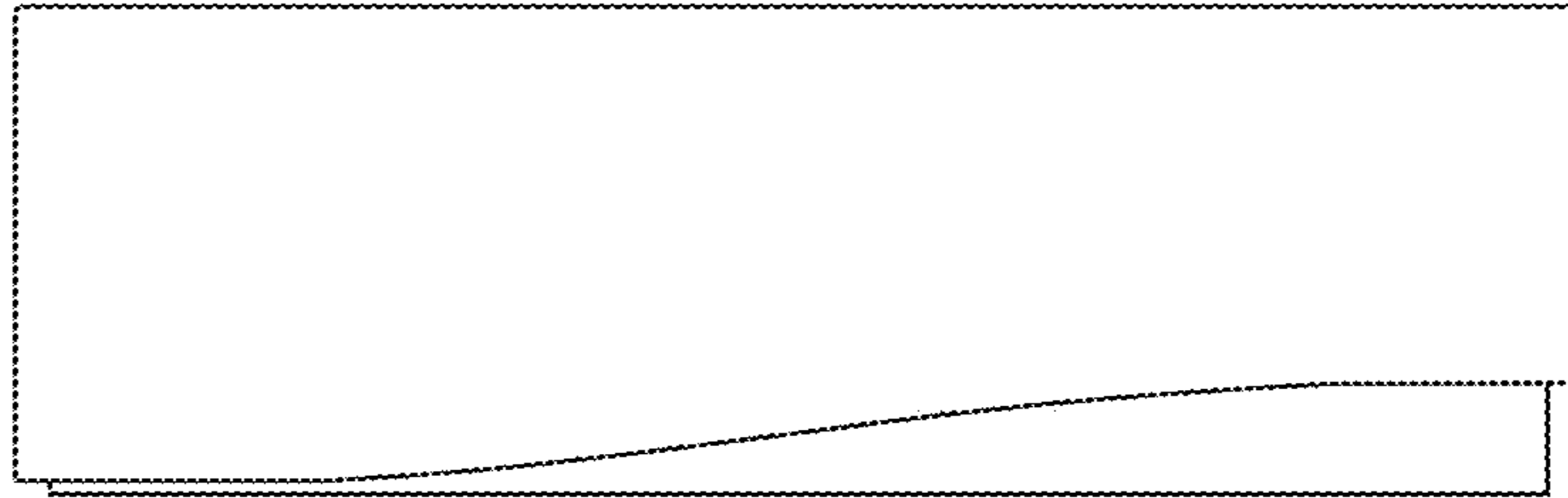

FIG. 2



FIG. 3

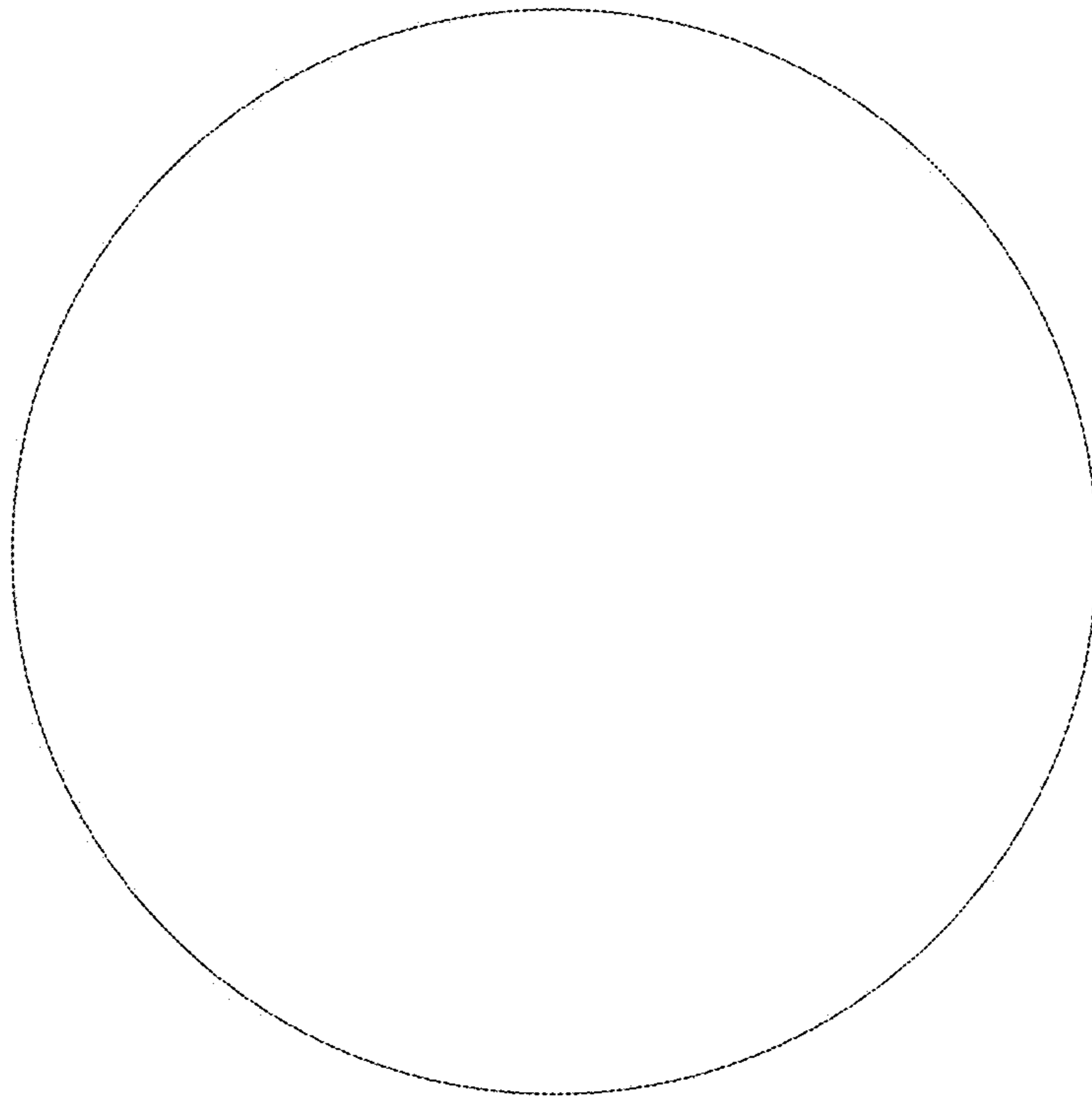

FIG. 4

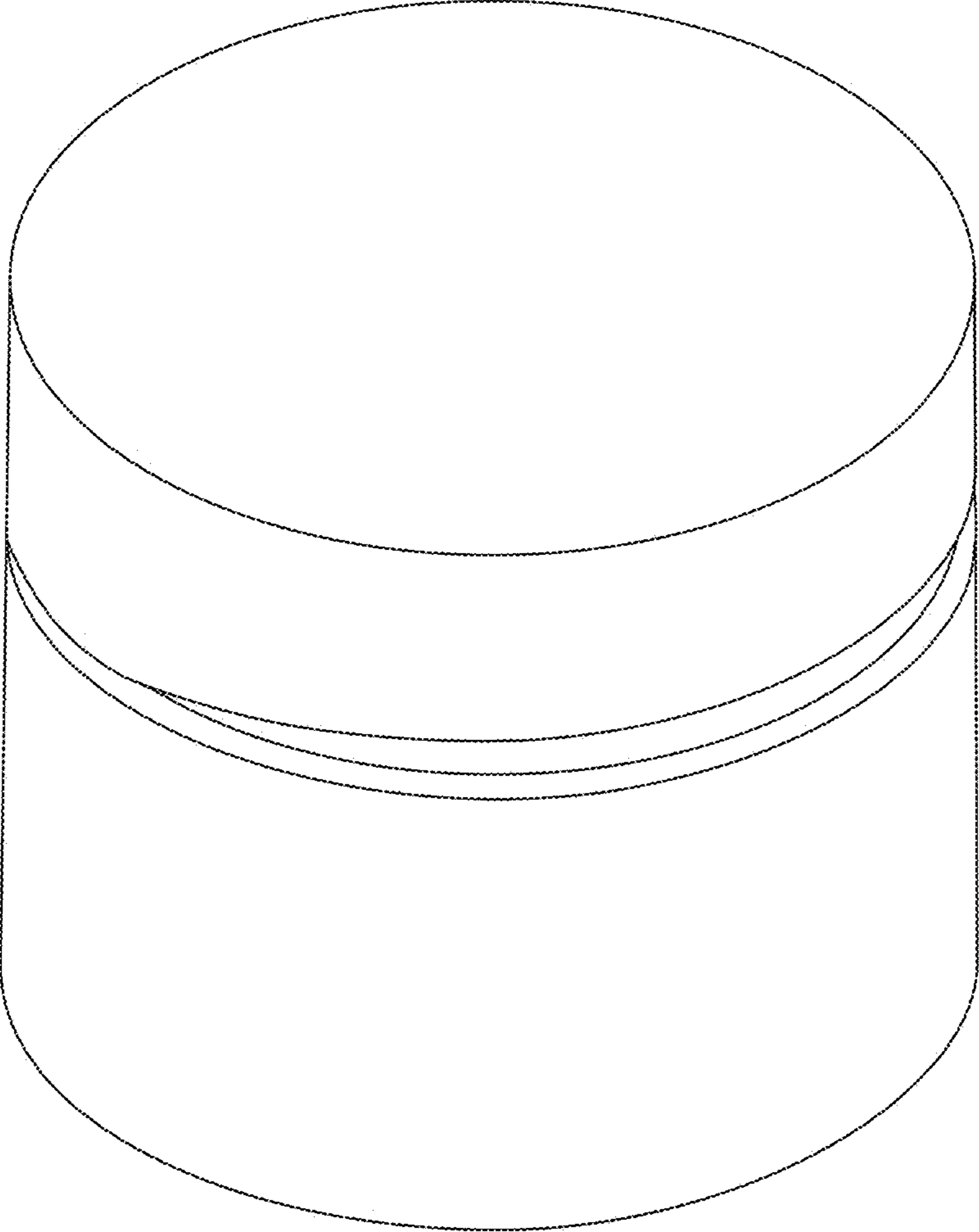

FIG. 5

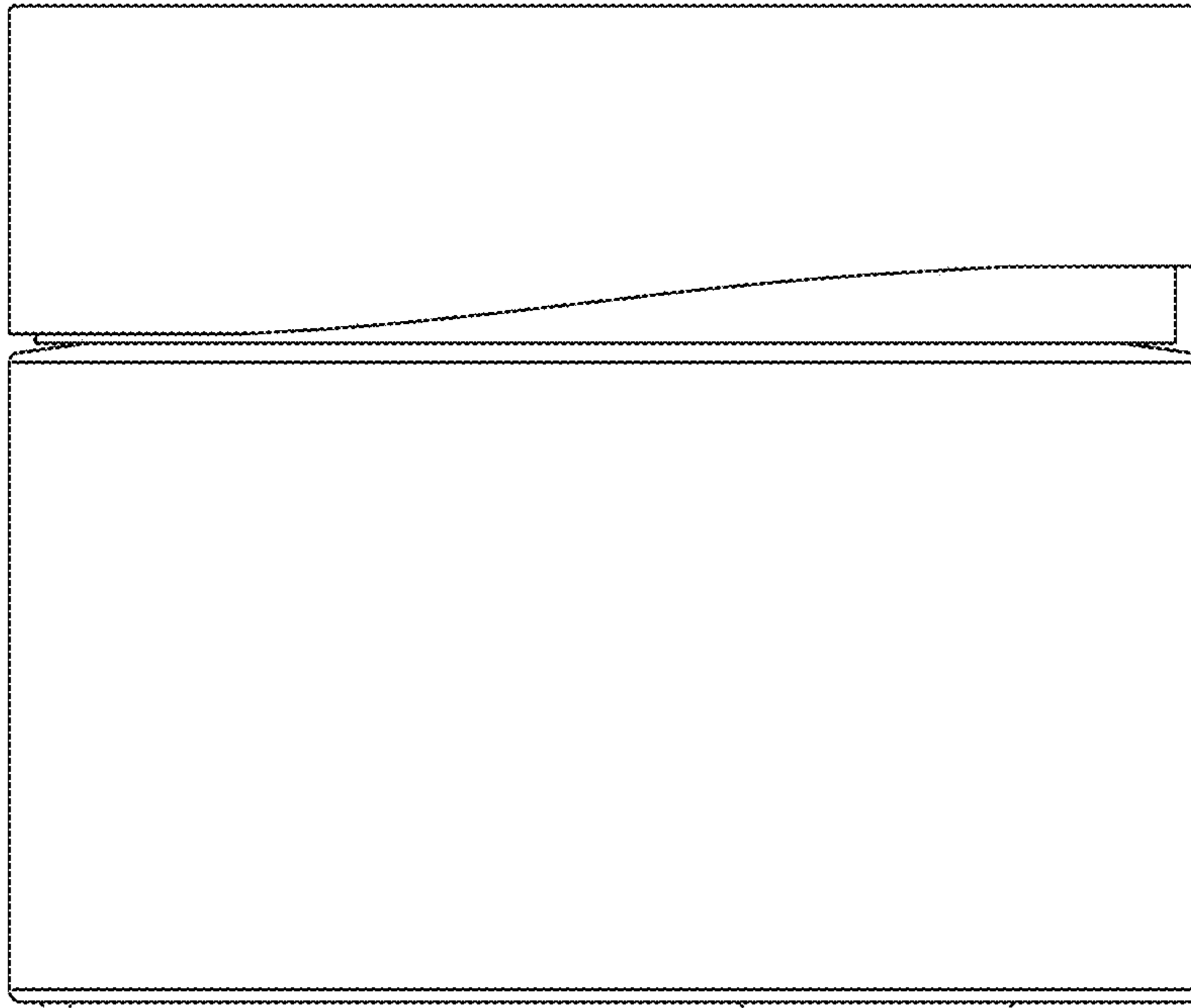

FIG. 6

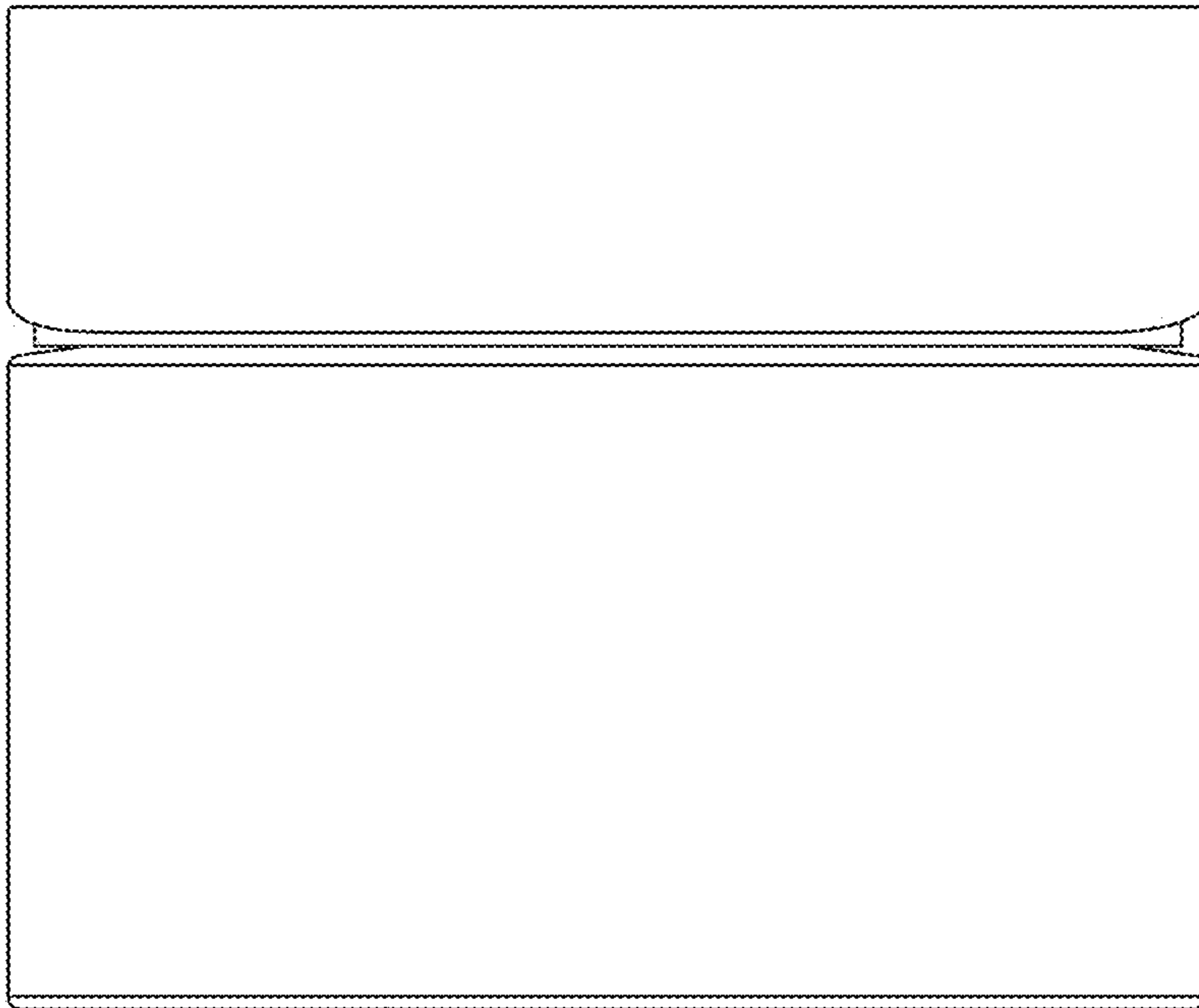

FIG. 7

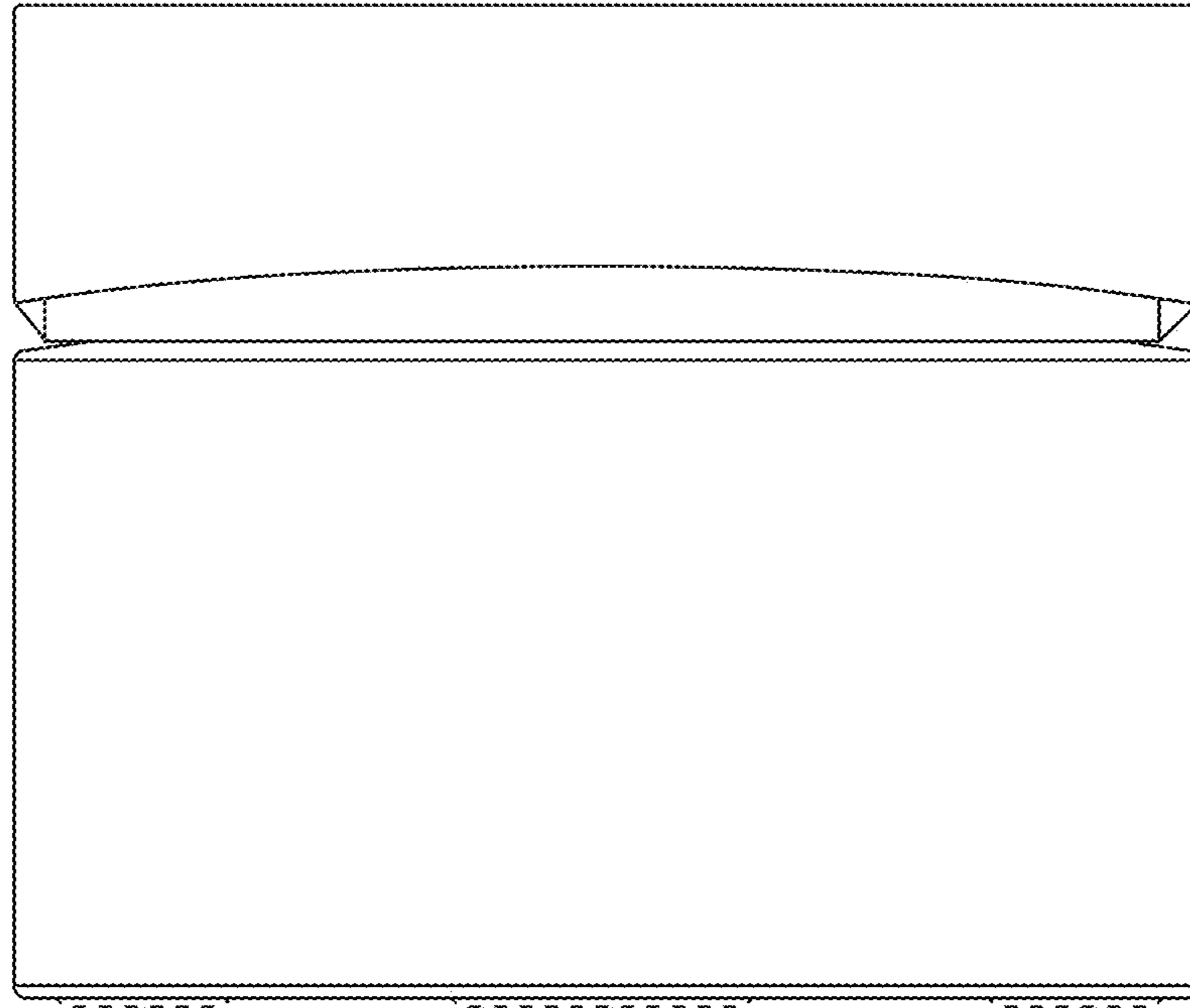

FIG. 8

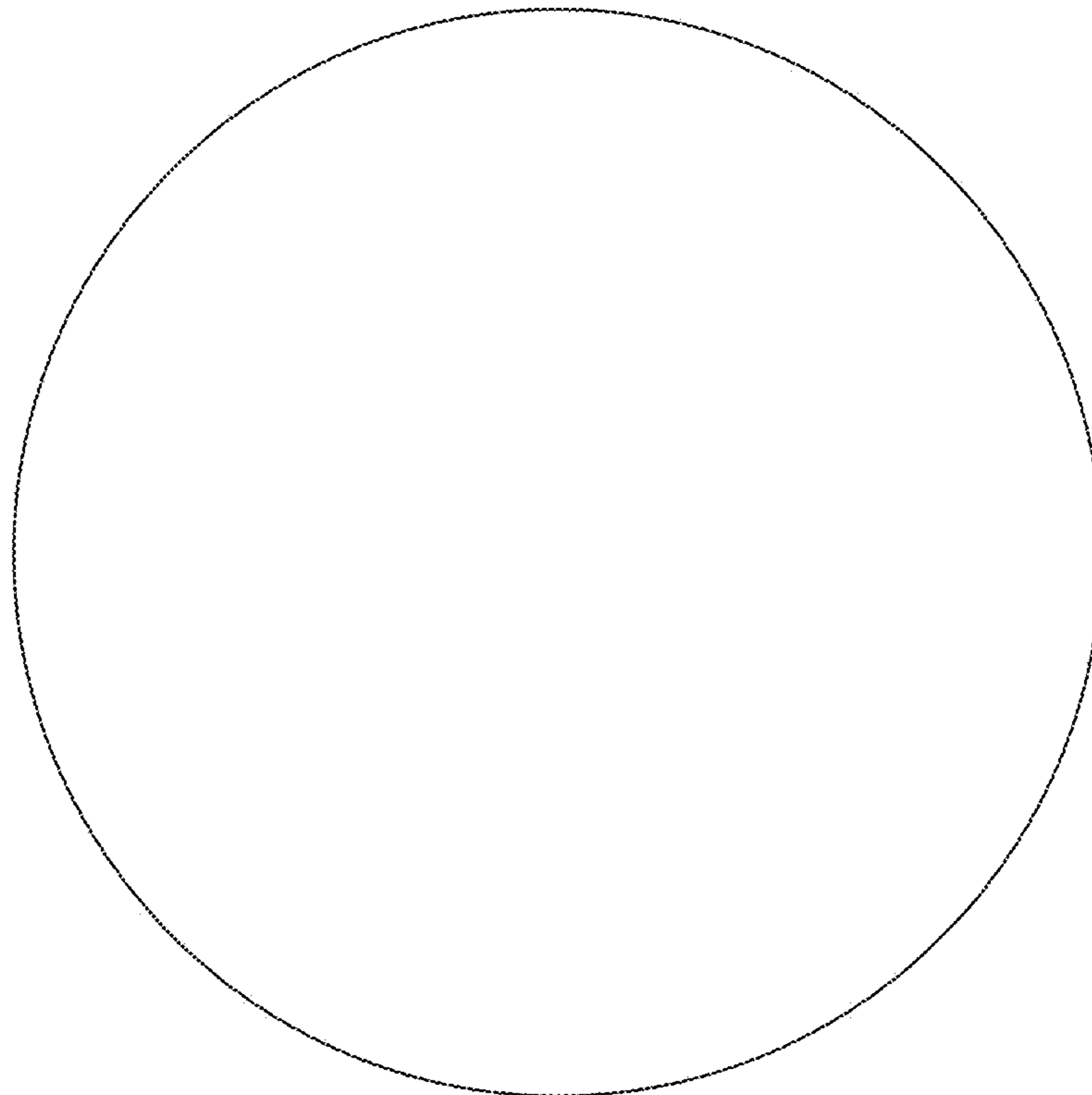

FIG. 9