



US00D844843S

(12) **United States Design Patent**
Ruggiero

(10) **Patent No.:** **US D844,843 S**

(45) **Date of Patent:** **** Apr. 2, 2019**

(54) **CAT DOOR**

(71) Applicant: **Lisa Ruggiero**, Coram, NY (US)

(72) Inventor: **Lisa Ruggiero**, Coram, NY (US)

(**) Term: **15 Years**

(21) Appl. No.: **29/578,987**

(22) Filed: **Sep. 27, 2016**

(51) **LOC (11) Cl.** **25-02**

(52) **U.S. Cl.**
USPC **D25/48.3**

(58) **Field of Classification Search**
USPC D25/48.1, 48.2, 48.3
CPC E06B 7/32; Y10S 160/08; Y10T 292/11;
Y10T 292/0962
See application file for complete search history.

(56) **References Cited**

U.S. PATENT DOCUMENTS

3,184,803	A *	5/1965	Peel	E06B 7/32
					292/157
3,690,299	A *	9/1972	Johnson	E06B 7/32
					119/174
4,173,099	A *	11/1979	Robb	E06B 7/32
					49/168
D267,436	S *	12/1982	Thorne	D25/48.3
D326,914	S *	6/1992	Kirk	D25/48.3
D334,431	S *	3/1993	Davlantes	D25/48.3
D334,809	S *	4/1993	Davlantes	D25/48.3
D334,810	S *	4/1993	Davlantes	D25/48.3
D353,207	S *	12/1994	Davlantes	D25/48.3
D382,649	S *	8/1997	Davlantes	D25/48.3
D387,179	S *	12/1997	Davlantes	D25/48.3
D389,247	S *	1/1998	Norried	D25/48.3
D400,265	S *	10/1998	Davlantes	D25/48.3
D406,904	S *	3/1999	Sronce	D25/48.3
D407,500	S *	3/1999	Gribble	D25/48.3
D445,915	S *	7/2001	Kirk	D25/48.3

(Continued)

FOREIGN PATENT DOCUMENTS

CN 304307023 * 10/2017

OTHER PUBLICATIONS

<http://www.hauspanther.com/2016/05/27/kitty-pass-interior-cat-door/> Posted May 27, 2016 (Year: 2016).*

(Continued)

Primary Examiner — Leanne Was-Englehart

(74) *Attorney, Agent, or Firm* — Dunlap Bennett & Ludwig PLLC

(57) **CLAIM**

The ornamental design for a cat door, as shown and described.

DESCRIPTION

FIG. 1 is a perspective view of a first embodiment of a cat door;

FIG. 2 is a front elevation view of FIG. 1;

FIG. 3 is a bottom plan view of FIG. 1;

FIG. 4 is a rear elevation view of FIG. 1;

FIG. 5 is a right elevation view of FIG. 1;

FIG. 6 is a top plan view of FIG. 1;

FIG. 7 is a left elevation view of FIG. 1;

FIG. 8 is a perspective view of a second embodiment of the cat door;

FIG. 9 is a right elevation view of FIG. 8;

FIG. 10 is a front plan view of FIG. 8;

FIG. 11 is a left elevation view of FIG. 8;

FIG. 12 is a bottom plan view of FIG. 8;

FIG. 13 is a rear elevation view of FIG. 8; and,

FIG. 14 is a top plan view of FIG. 8.

The broken lines showing the cat depicts environmental subject matter that forms no part of the claimed design, while the remaining broken lines shown in the drawings depict portions of the cat door that form no part of the claimed design.

1 Claim, 6 Drawing Sheets

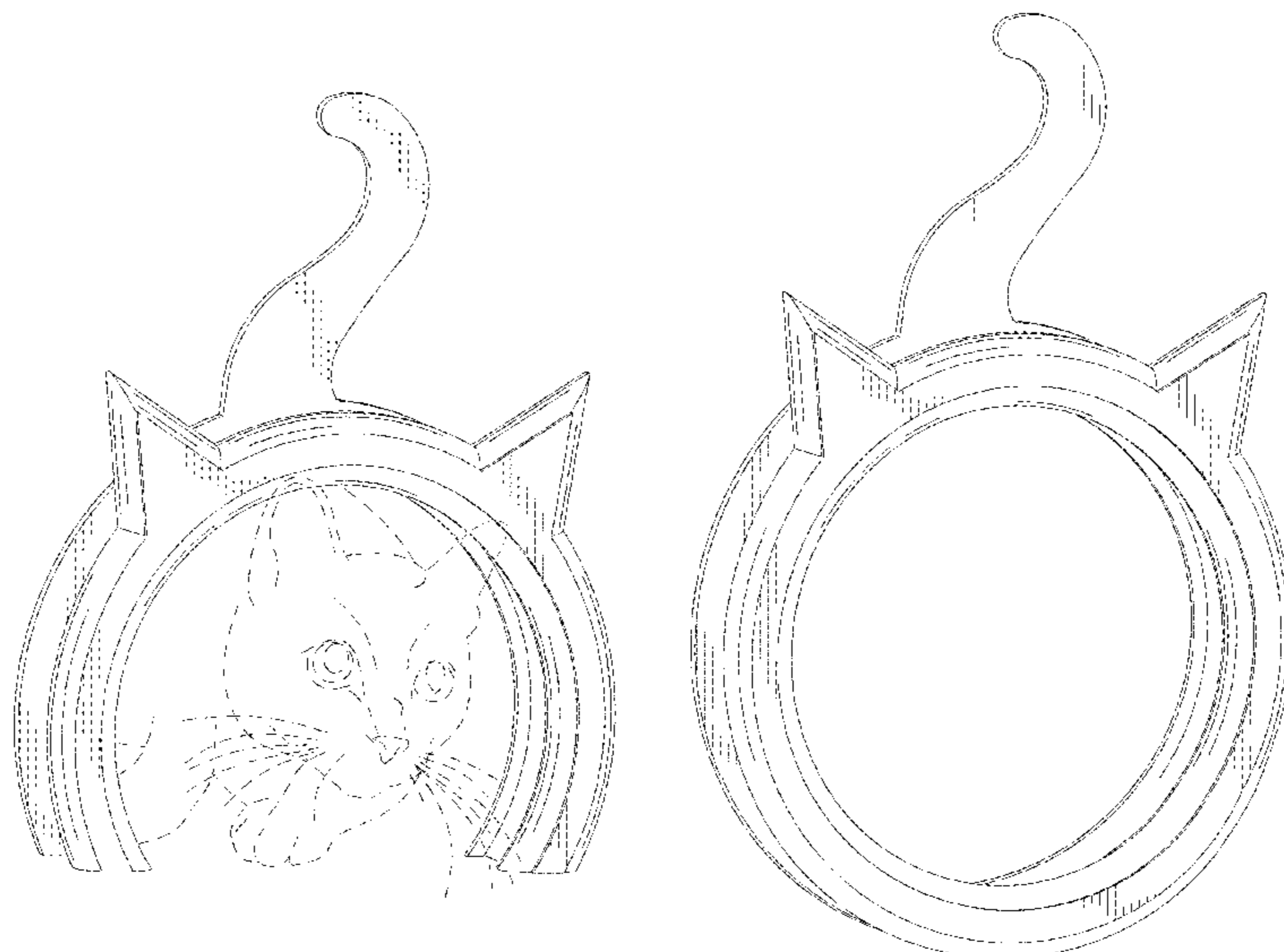

(56)

References Cited

U.S. PATENT DOCUMENTS

D556,955 S * 12/2007 Hanks D30/119
2008/0163550 A1 * 7/2008 Lomax E06B 7/32
49/169

OTHER PUBLICATIONS

<http://www.hauspanther.com/2017/02/07/new-kitty-pass-wall-entry-cat-door/> Posted Feb. 7, 2017 (Year: 2017).*

* cited by examiner

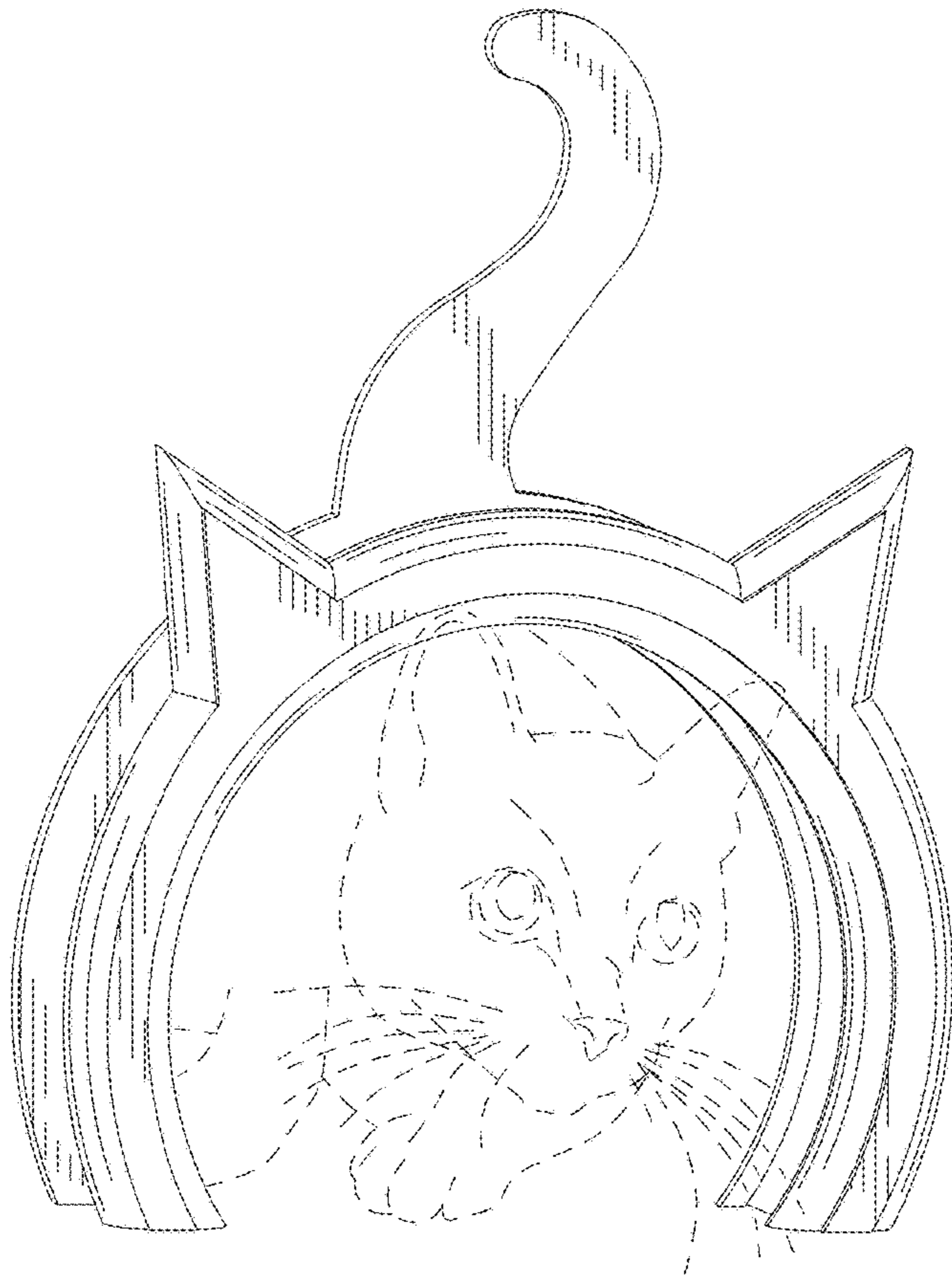

FIG.1

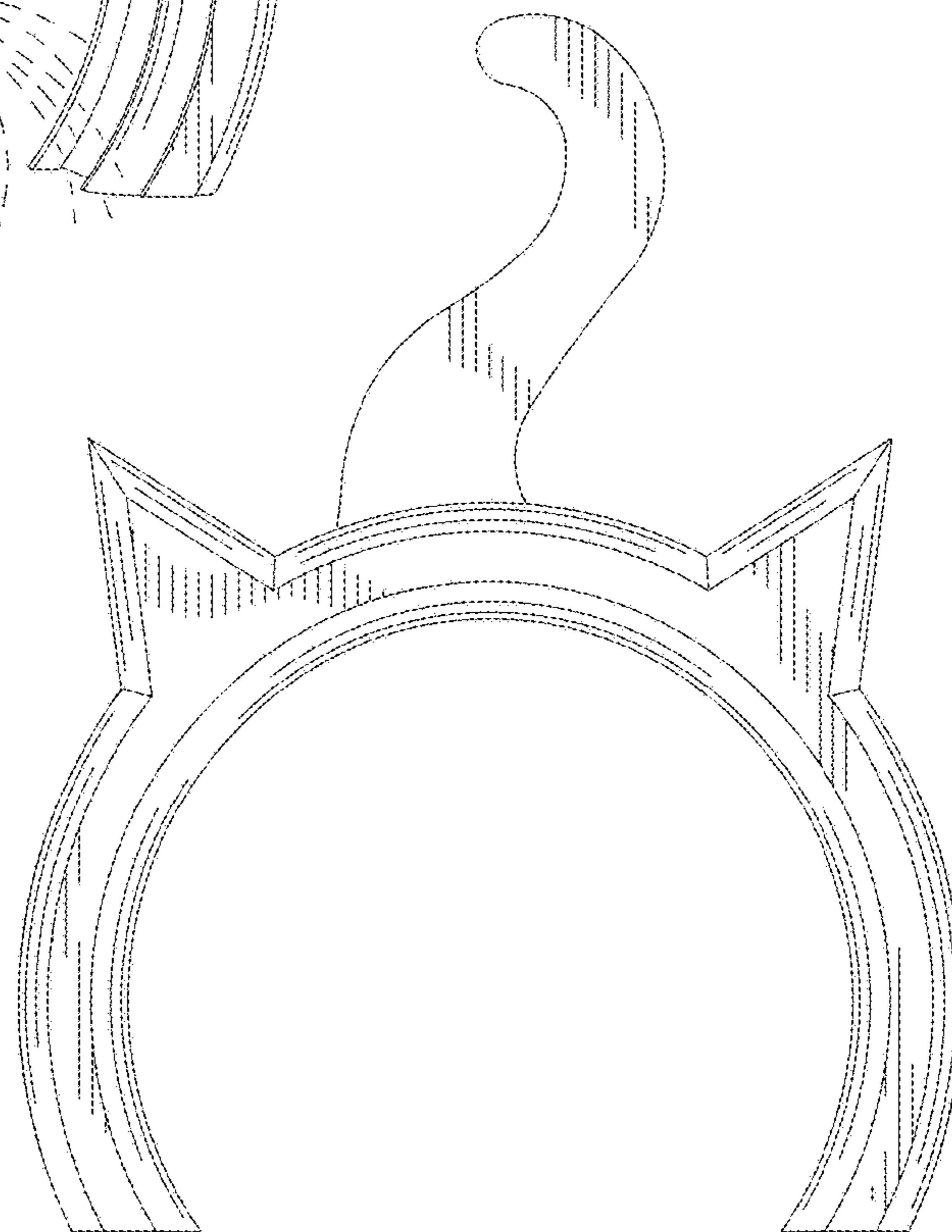

FIG.2

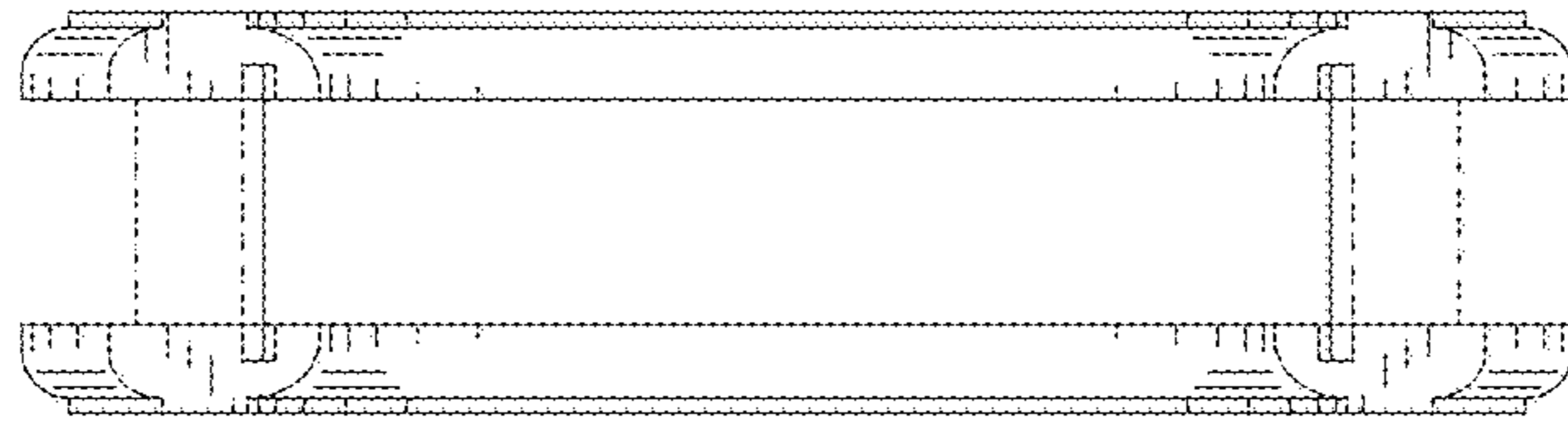

FIG. 3

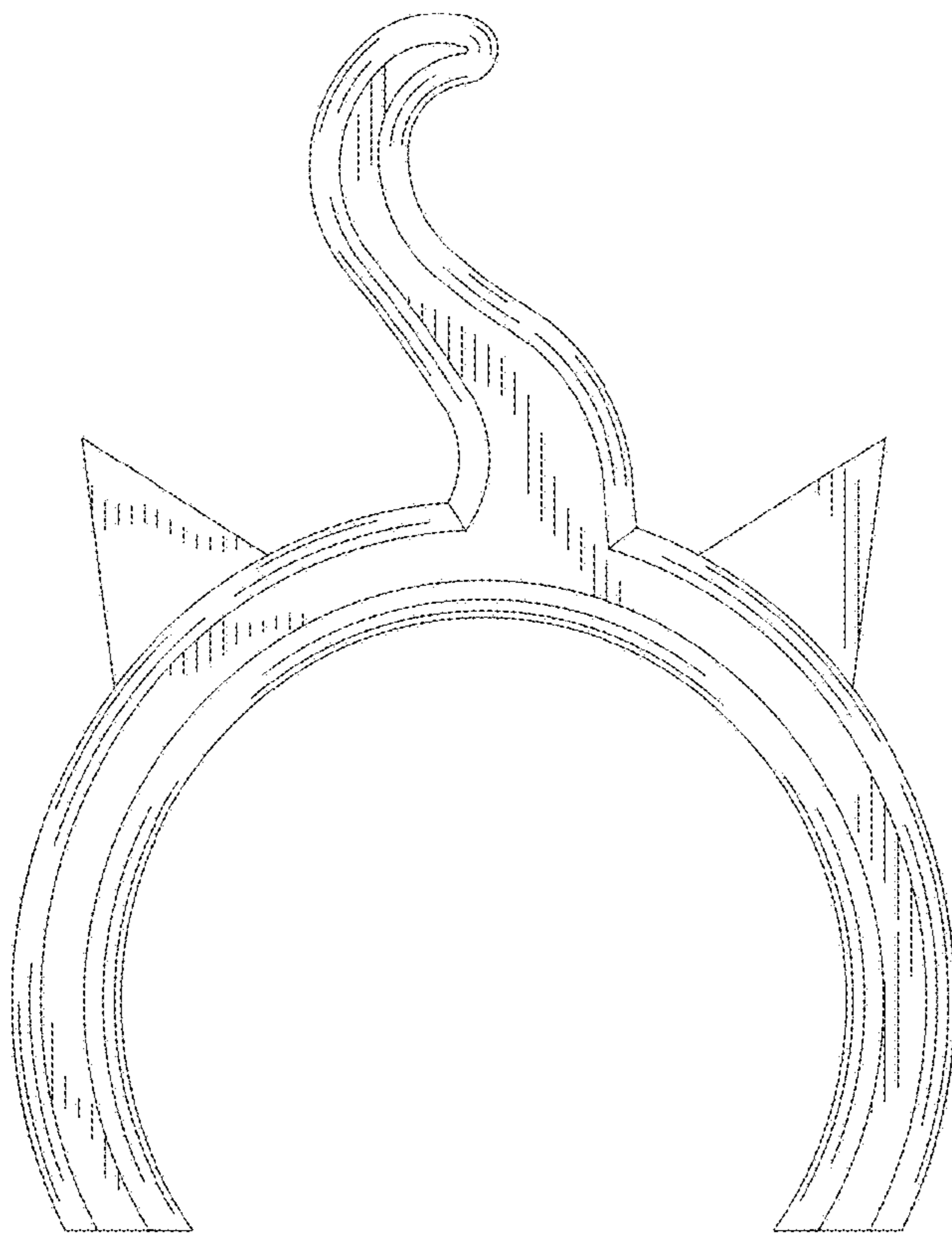

FIG. 4

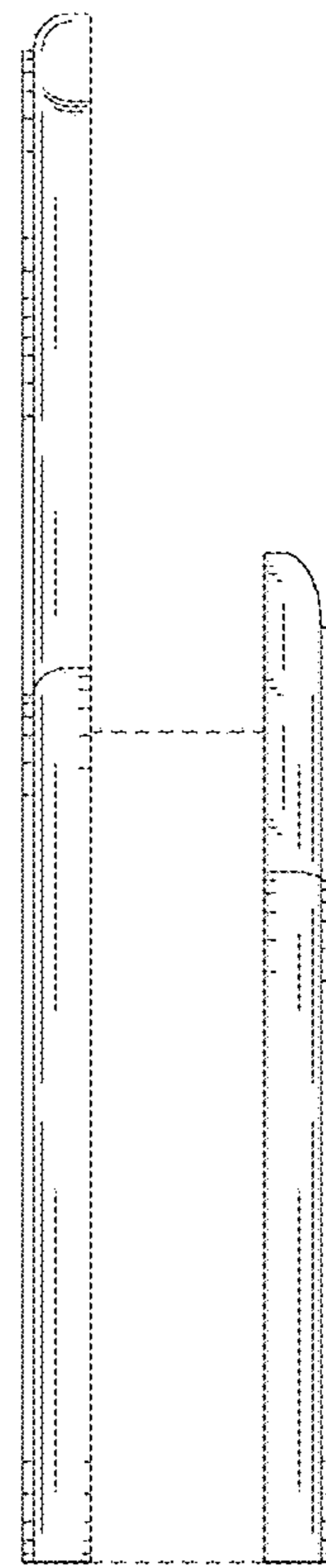

FIG. 5

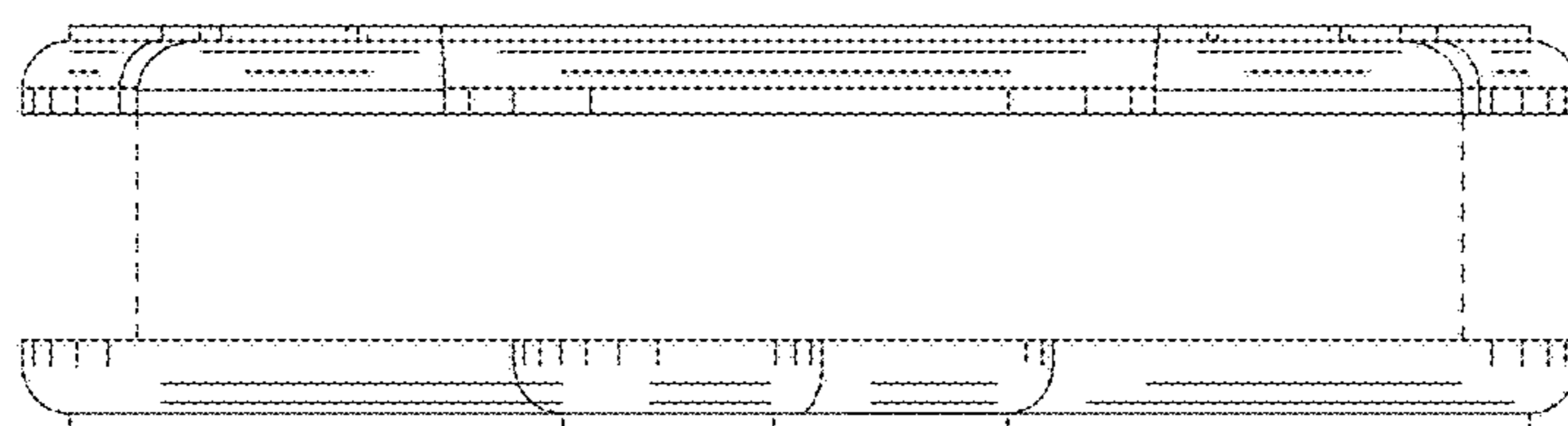

FIG. 6

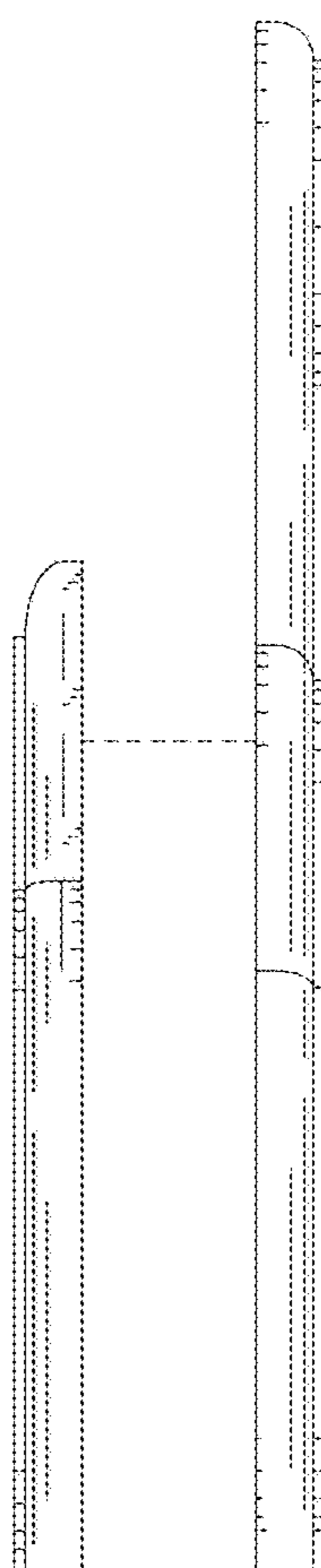

FIG. 7

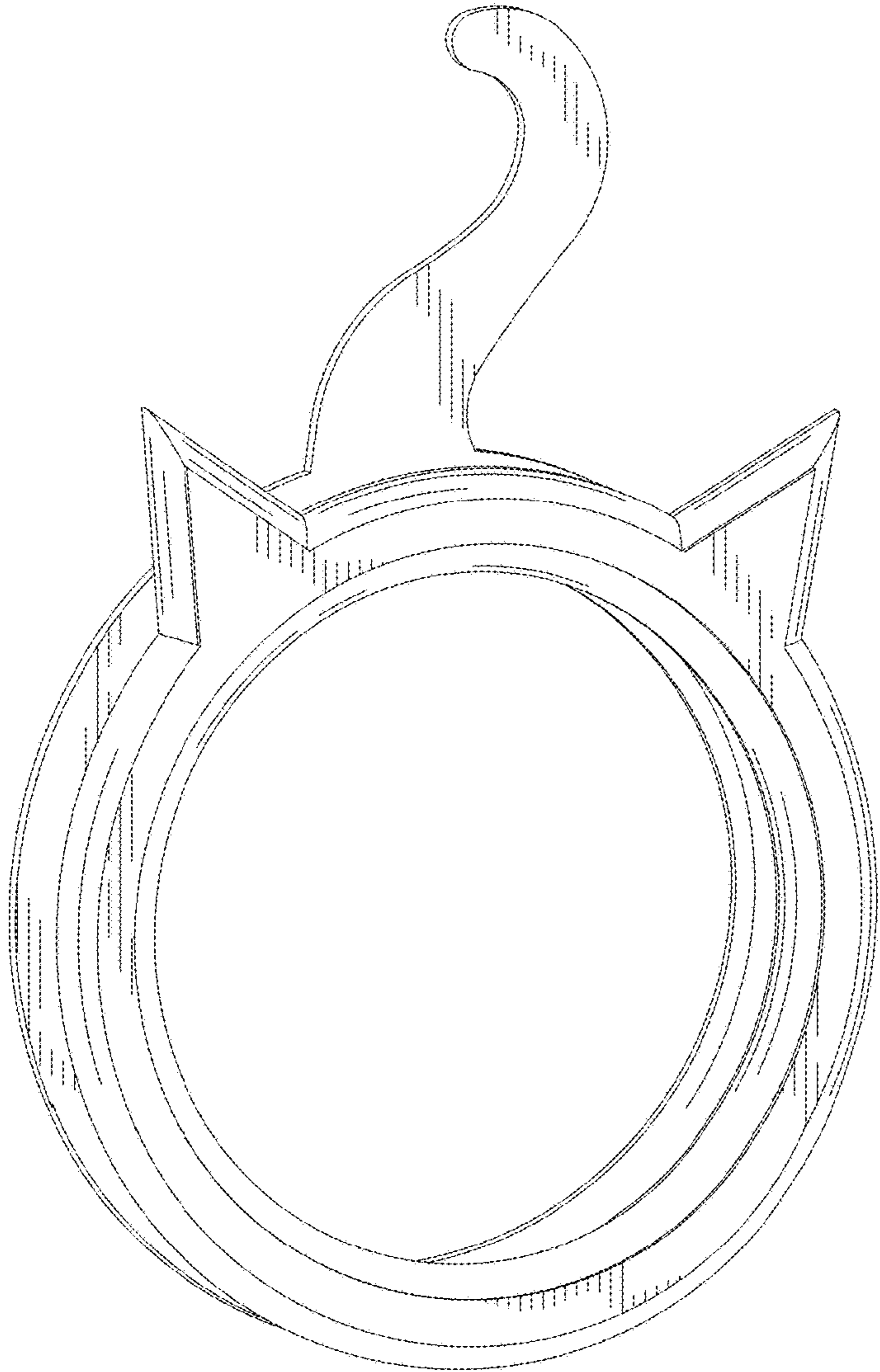

FIG. 8

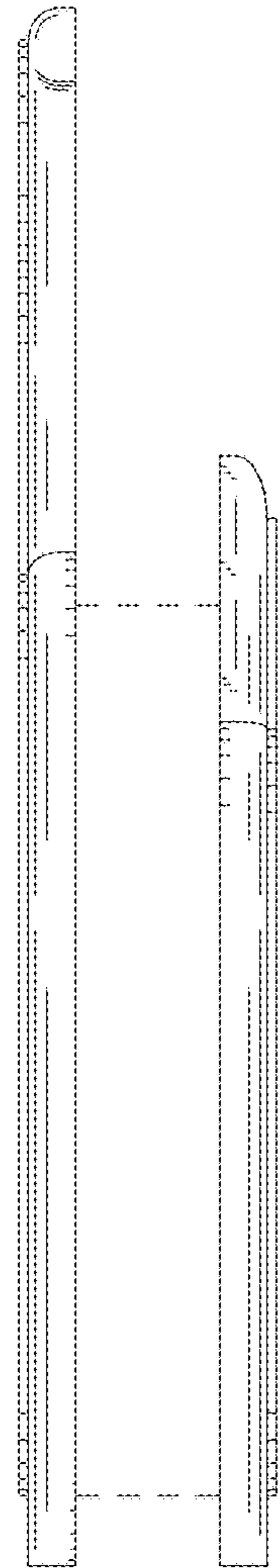

FIG. 9

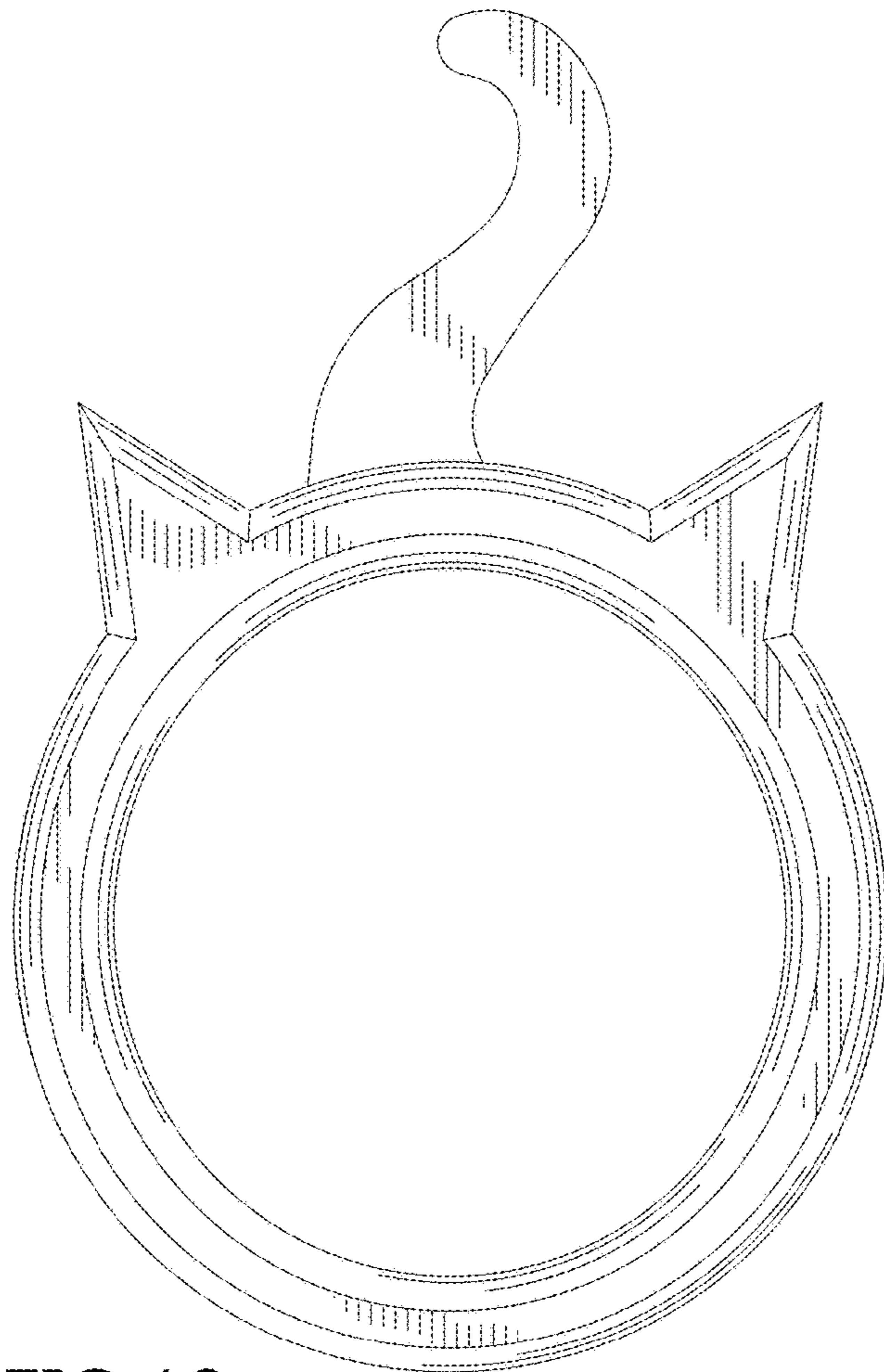

FIG. 10

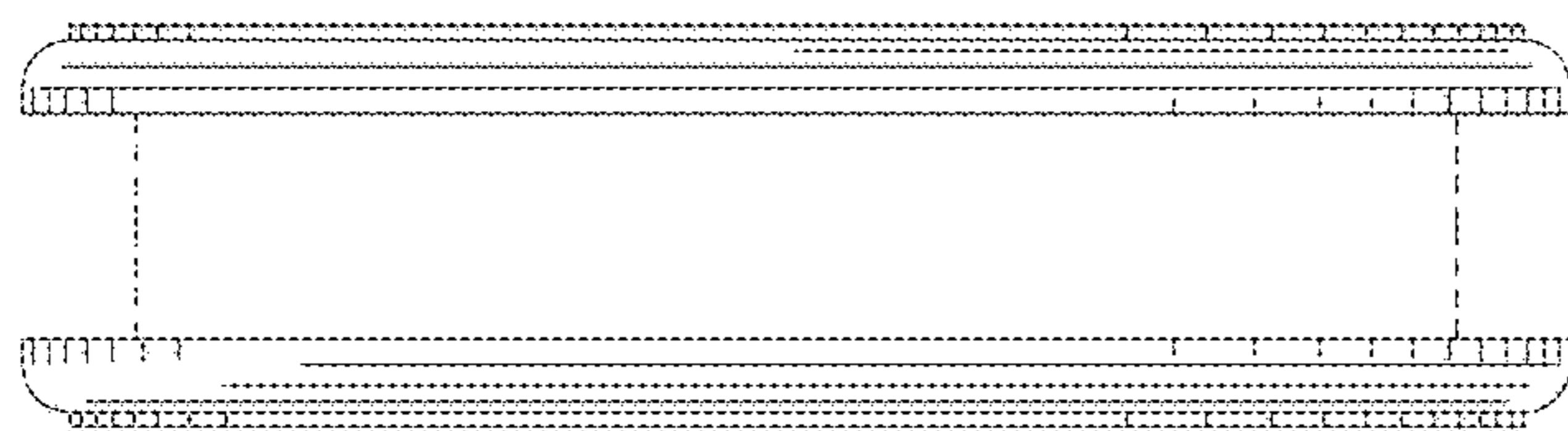

FIG. 11

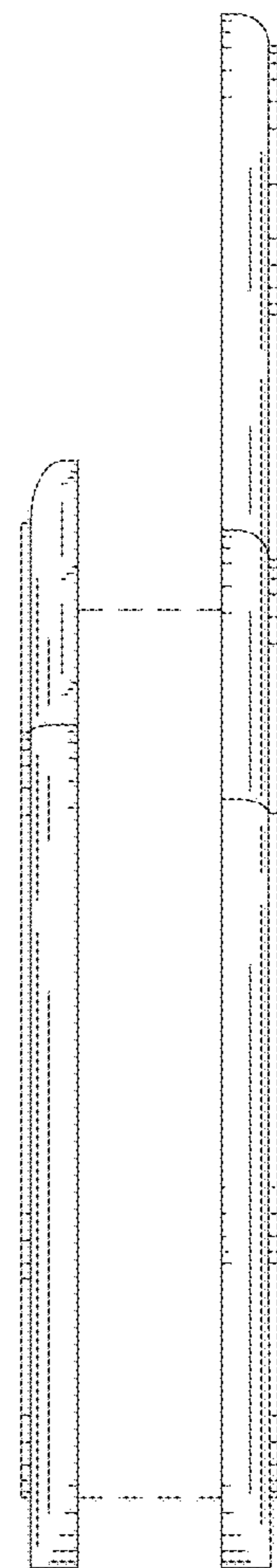

FIG. 12

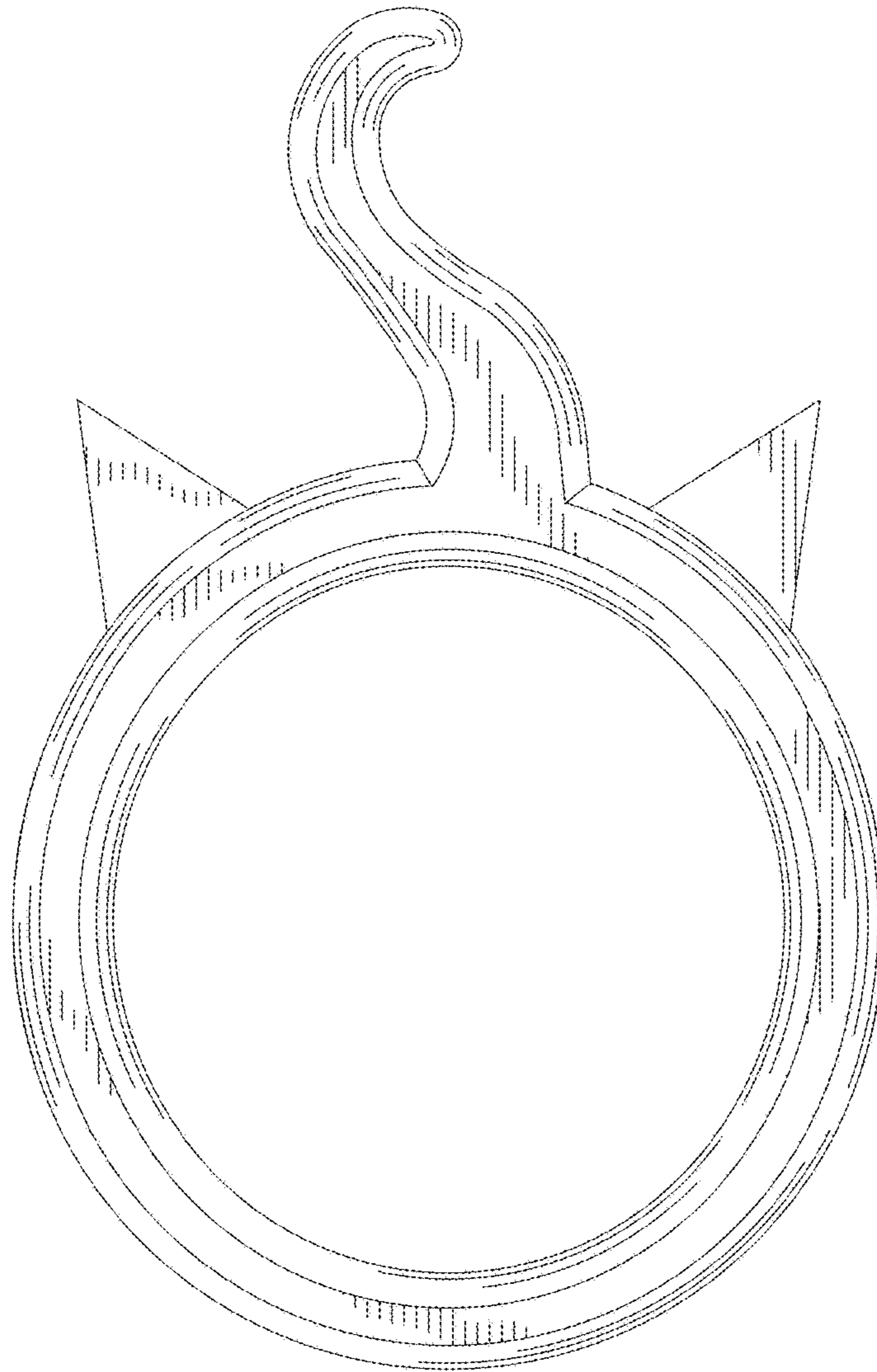

FIG. 13

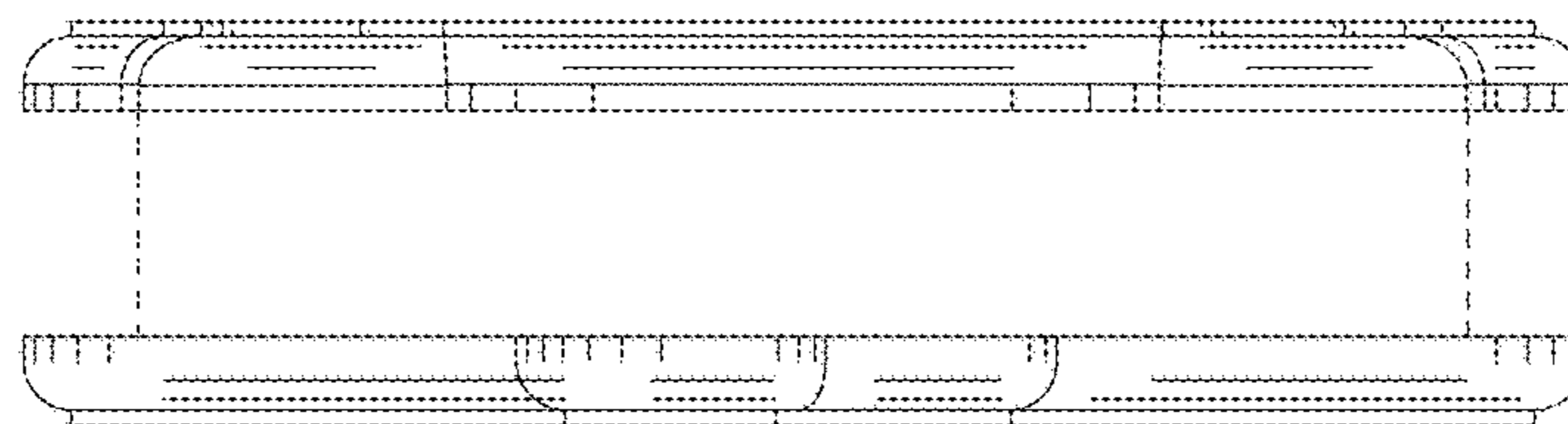

FIG. 14