



US00D844837S

(12) **United States Design Patent** (10) **Patent No.:** **US D844,837 S**
Gill et al. (45) **Date of Patent:** **** *Apr. 2, 2019**

(54) **MODULAR BUILDING**
(71) Applicant: **KwikSpace Guam**, Hagatna, GU (US)
(72) Inventors: **Peter E. Gill**, Tamuning, GU (US);
Peter E. Gill, III, Tamuning, GU (US)
(73) Assignee: **KWIKSPACE GUAM**, Hagatna, GU (US)
(*) Notice: This patent is subject to a terminal disclaimer.
(**) Term: **15 Years**
(21) Appl. No.: **29/610,399**
(22) Filed: **Jul. 12, 2017**
(51) **LOC (11) Cl.** **25-03**
(52) **U.S. Cl.**
USPC **D25/33**
(58) **Field of Classification Search**
USPC D25/1, 3, 4, 12, 15-34, 56, 61; D21/837;
135/122, 906, 115
CPC E04H 6/44; E04H 6/025; E04H 1/1205;
E04H 15/36; E04H 15/322; E04H 15/44;
E04H 2001/1283; E04H 1/04; E04H 1/02;
E04H 9/14; E04B 1/342; E04B 1/3205;
E04B 1/34305; E04B 7/166; E04B
1/38415
See application file for complete search history.

(56) **References Cited**
U.S. PATENT DOCUMENTS
5,706,614 A 1/1998 Wiley, Jr. et al.
D390,970 S * 2/1998 Abrams D25/1
7,712,265 B2 * 5/2010 Overmyer, Jr. E04H 1/02
52/143
8,001,730 B2 8/2011 Wallance
D683,047 S * 5/2013 Gill D25/22
8,640,396 B1 * 2/2014 Gill E04H 1/12
52/79.7
D727,531 S * 4/2015 Gill D25/22

D781,439 S * 3/2017 Gill D25/1
D781,440 S * 3/2017 Gill D25/1
D781,441 S * 3/2017 Gill D25/1
D781,442 S * 3/2017 Gill D25/32
D781,443 S * 3/2017 Gill D25/32
D781,444 S * 3/2017 Gill D25/32
D783,179 S * 4/2017 Gill D25/32
D783,857 S * 4/2017 Gill D25/1
D814,658 S * 4/2018 Gill D25/33
2003/0009954 A1 * 1/2003 Bradley E04H 1/1205
52/79.1
2005/0066589 A1 * 3/2005 Bedell E04B 1/34815
52/79.1
2005/0262778 A1 * 12/2005 Allen E04B 1/34815
52/79.1
2010/0043308 A1 * 2/2010 Keeble E04B 1/34321
52/79.1
2017/0260737 A1 * 9/2017 Ota E04H 1/02

* cited by examiner
Primary Examiner — Brett Miller
(74) *Attorney, Agent, or Firm* — Donald J. Ersler

(57) **CLAIM**
The ornamental design for a modular building, as shown and described.

DESCRIPTION
FIG. 1 is a top perspective view of a modular building incorporating our new design;
FIG. 2 is a bottom perspective view thereof;
FIG. 3 is a left side view thereof;
FIG. 4 is a left side view thereof;
FIG. 5 is a front view thereof;
FIG. 6 is a rear view thereof;
FIG. 7 is a top plan view thereof; and,
FIG. 8 is a bottom plan view thereof.
The broken lines shown in the drawings illustrate portions of the modular building that form no part of the claimed invention.

1 Claim, 6 Drawing Sheets

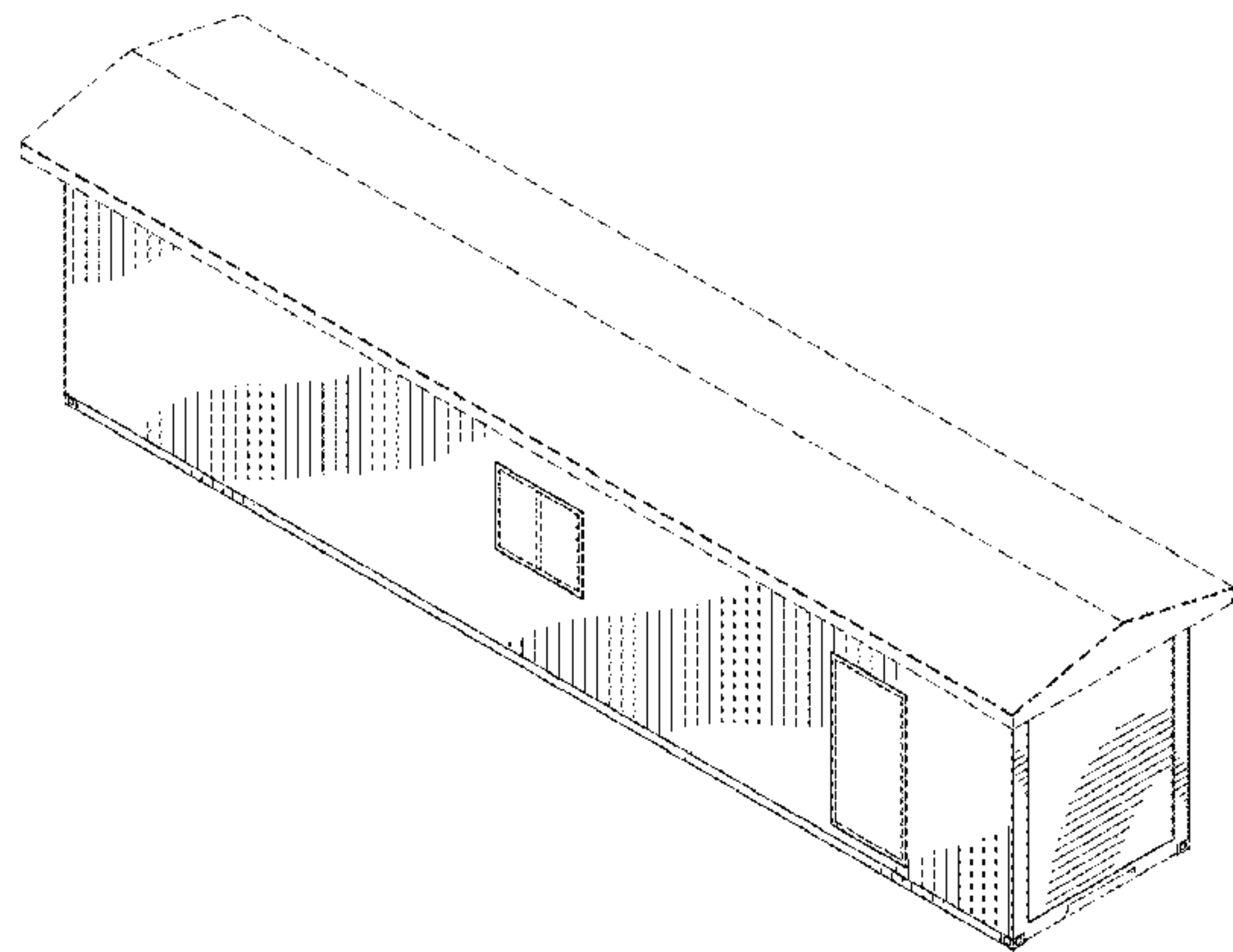

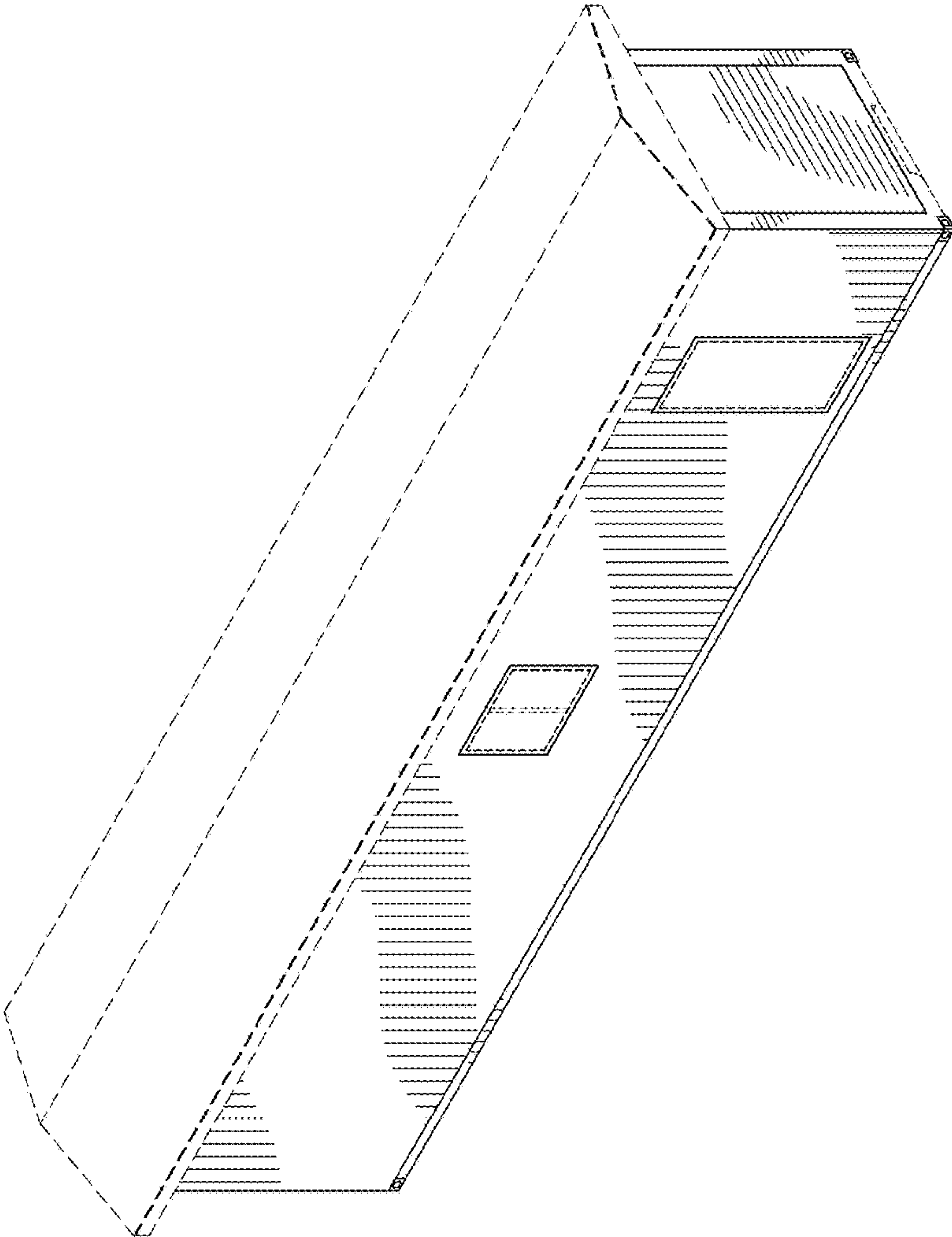

FIG. 1

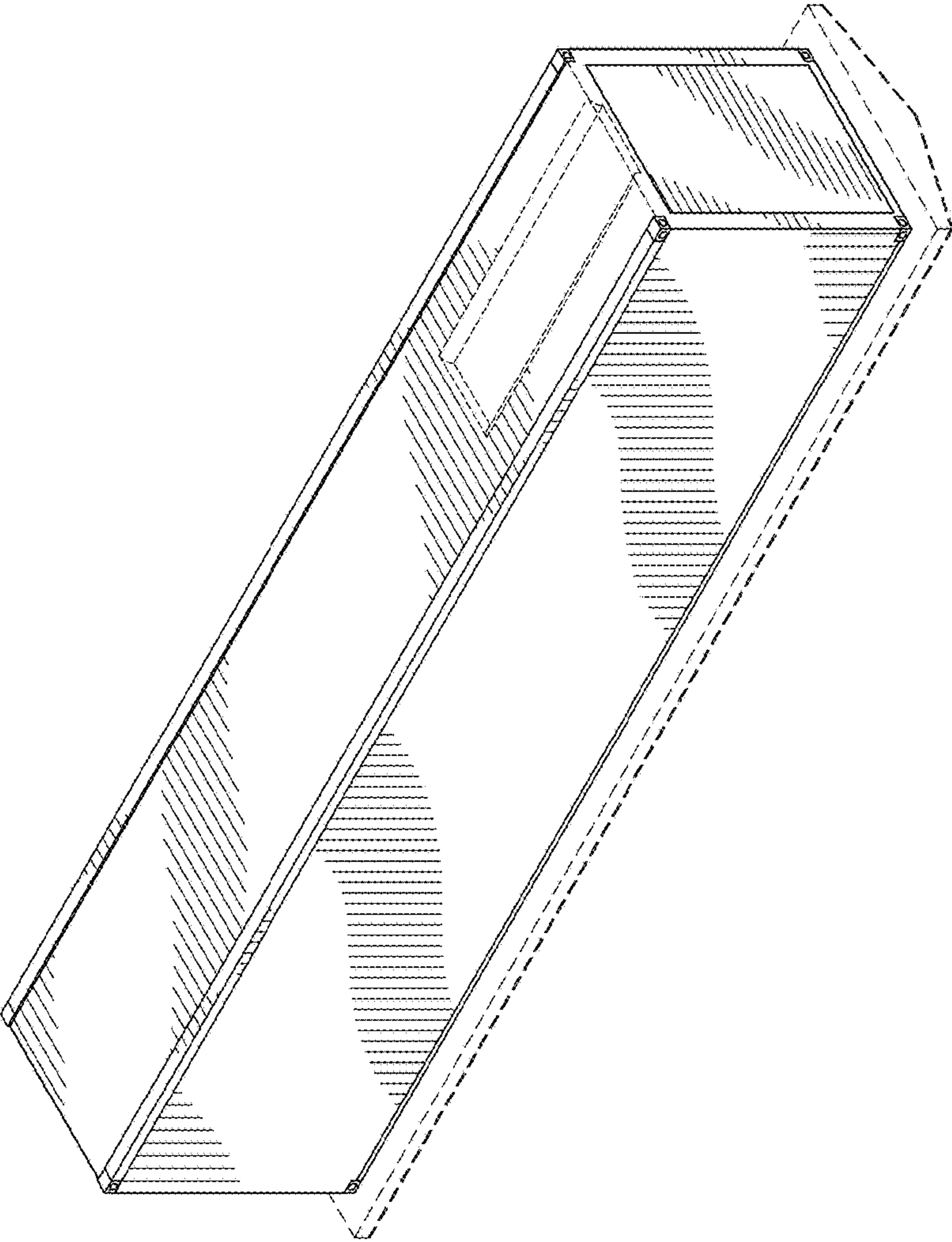

FIG. 2

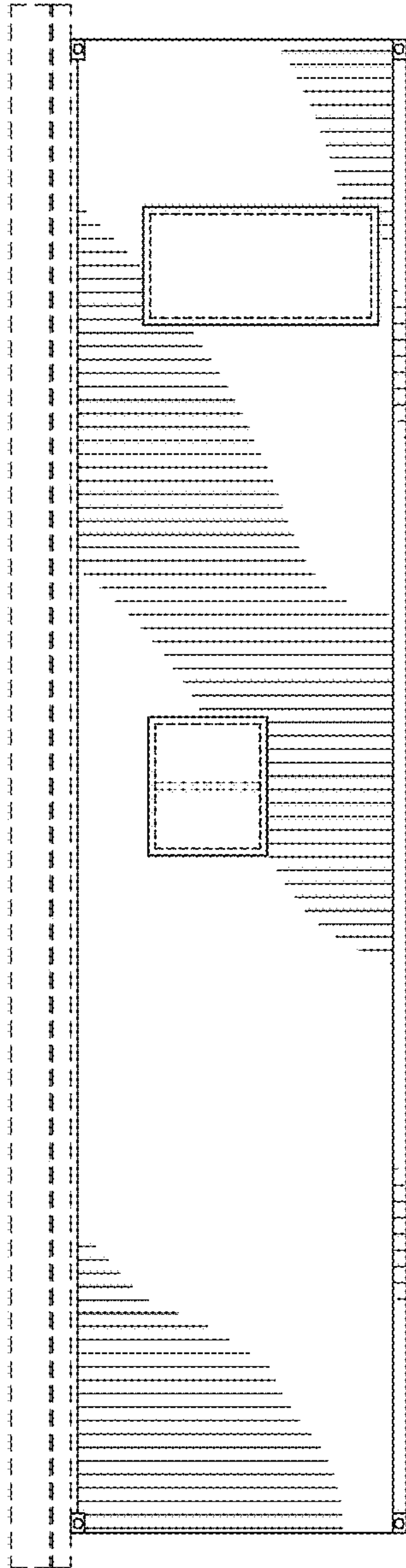

FIG. 3

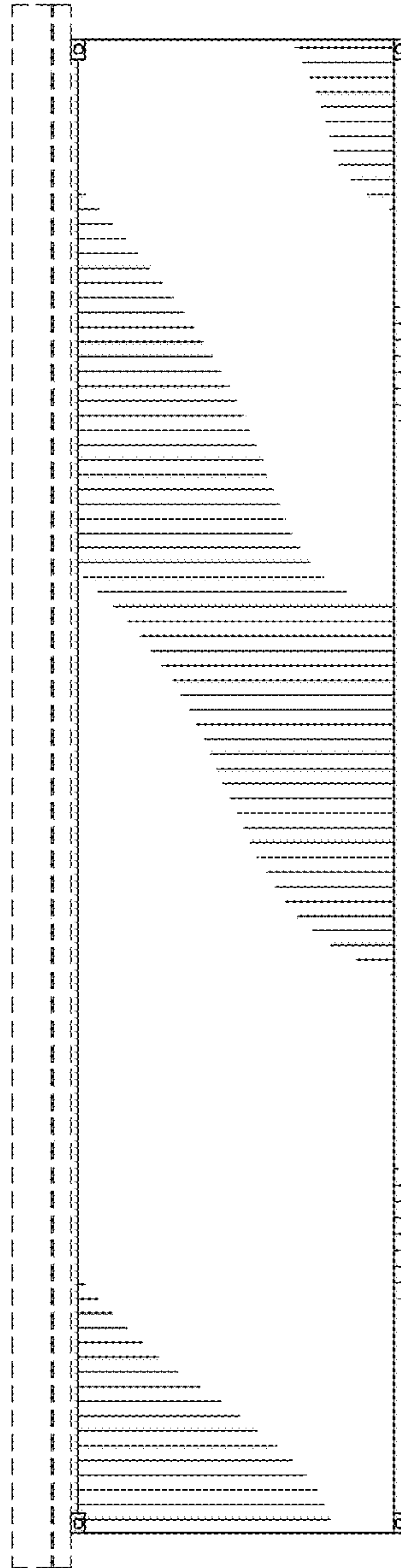

FIG. 4

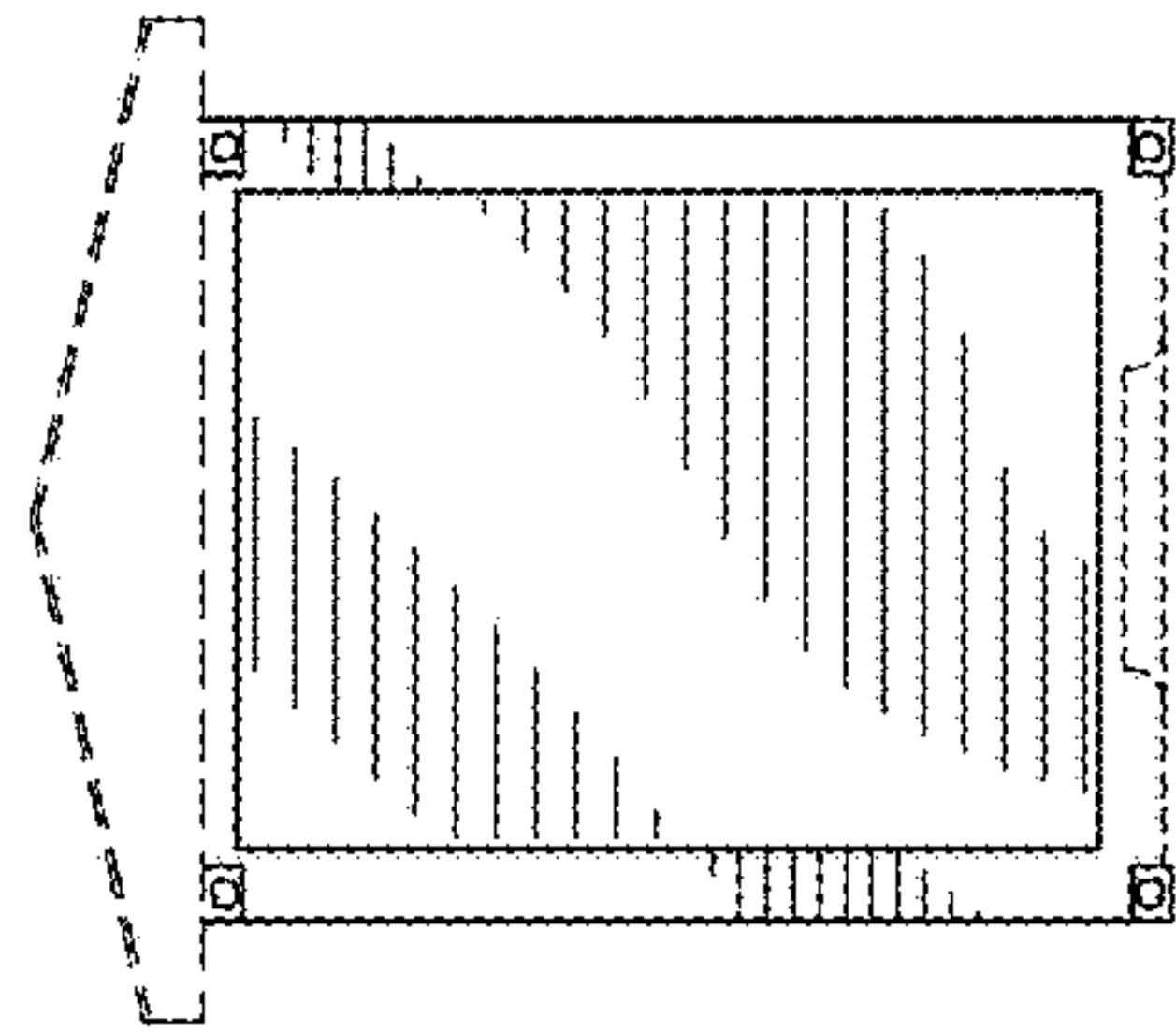

FIG. 5

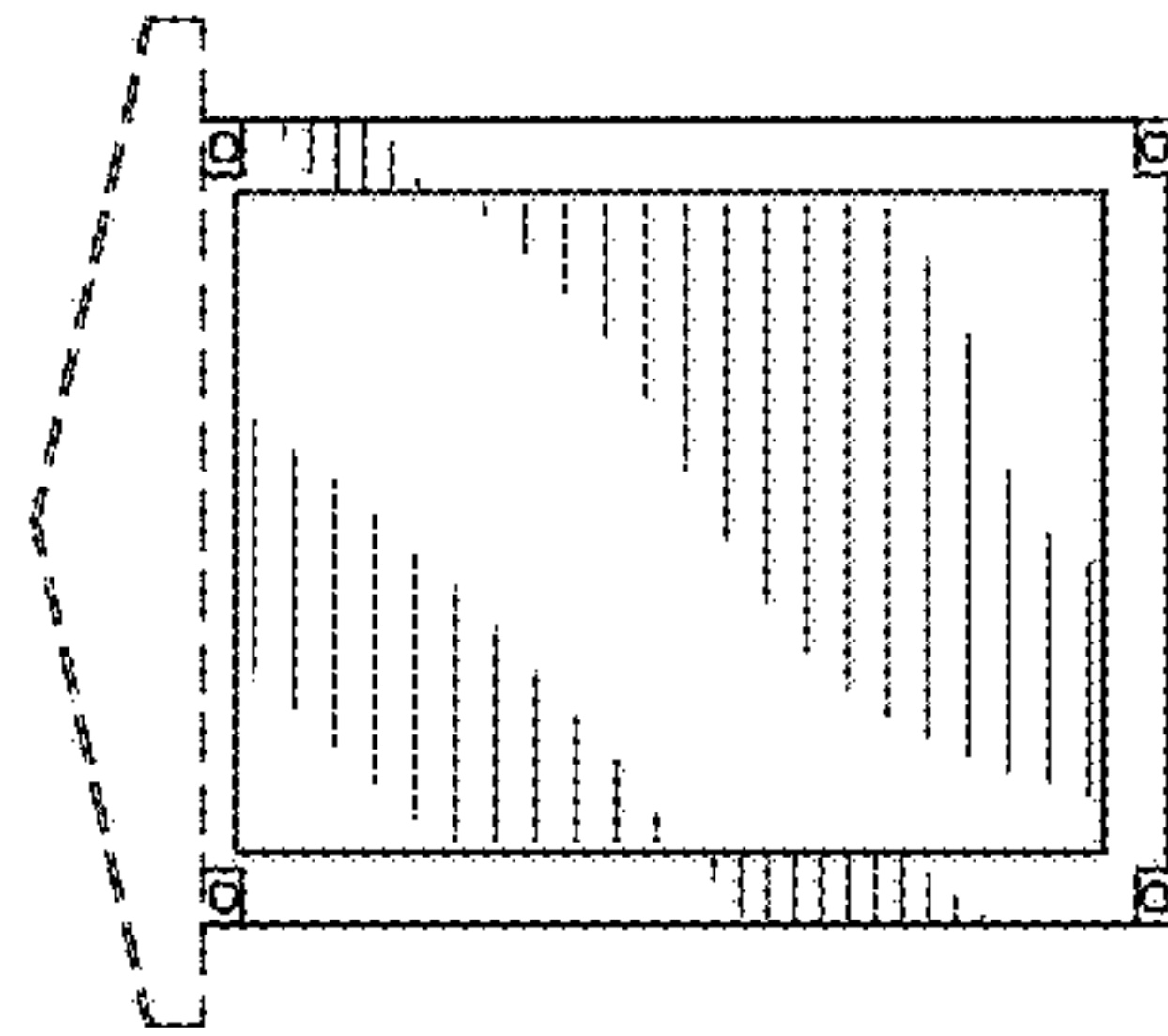

FIG. 6

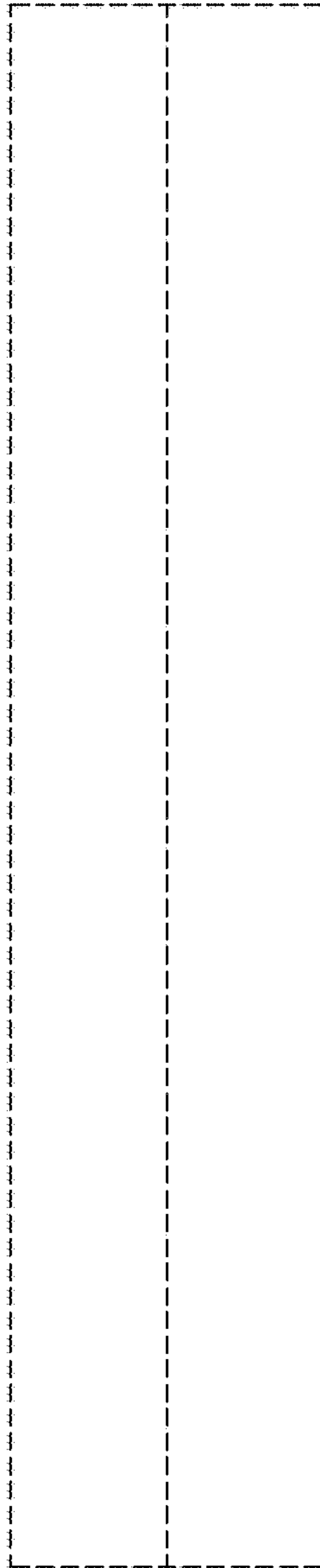

FIG. 7

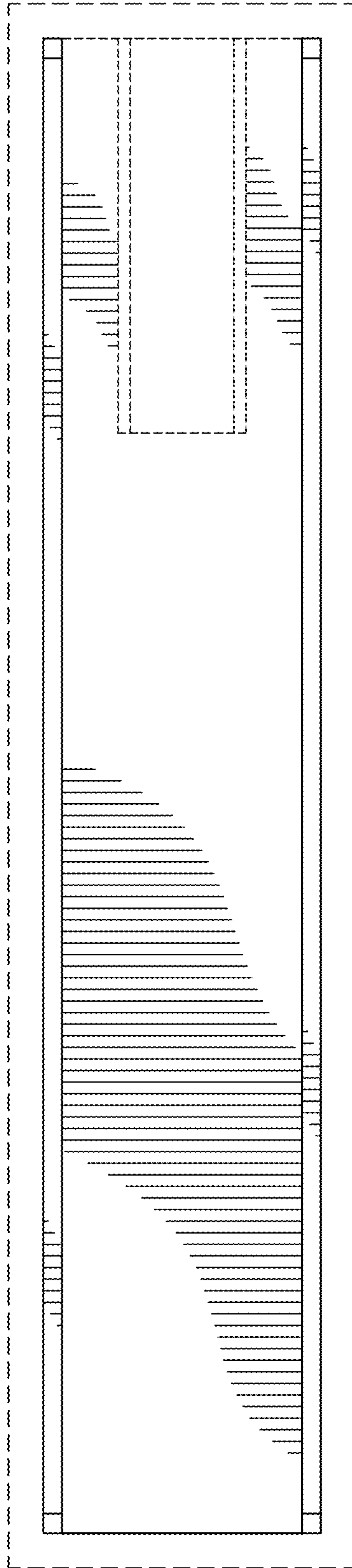

FIG. 8