



US00D844822S

(12) **United States Design Patent**
Berman et al.

(10) **Patent No.:** **US D844,822 S**
(45) **Date of Patent:** **** Apr. 2, 2019**

(54) **SHELTER**
(71) Applicants: **Kenneth M. Berman**, Sebastopol, CA (US); **Clare Monteschio**, Sebastopol, CA (US)
(72) Inventors: **Kenneth M. Berman**, Sebastopol, CA (US); **Clare Monteschio**, Sebastopol, CA (US)

5,507,121 A * 4/1996 Taylor E04H 6/005
49/40
6,467,221 B1 * 10/2002 Bigelow B64D 11/00
52/79.1
D627,480 S * 11/2010 Pinke D25/18
D664,667 S * 7/2012 Krymov D25/16
D734,491 S * 7/2015 Krymov D25/16
9,920,547 B1 * 3/2018 Greenblatt E04B 1/3205
D826,787 S * 8/2018 Goral D12/103
2009/0217617 A1 * 9/2009 Kennedy E04B 1/3205
52/781

(**) Term: **15 Years**

(21) Appl. No.: **29/597,865**

(22) Filed: **Mar. 21, 2017**

(51) **LOC (11) Cl.** **25-03**

(52) **U.S. Cl.**
USPC **D25/18; D21/834**

(58) **Field of Classification Search**
USPC D25/1, 4, 15, 16, 18, 23, 26, 32, 33, 14;
D21/834, 837, 838; 52/79.1, 169.6;
D12/103-104
CPC E04H 1/1205; E04H 1/02; E04H 1/12;
E04H 9/14; E04H 9/16; E04H 15/001;
E04H 15/008; E04H 15/38; E04H
2001/1283; E04H 9/12; E04H 9/08; E04H
9/10; E04B 1/3205

See application file for complete search history.

(56) **References Cited**

U.S. PATENT DOCUMENTS

D209,136 S * 11/1967 Christin D12/103
4,239,247 A * 12/1980 Hinz E04H 15/001
135/133
D305,790 S * 1/1990 Soderstrom D21/834
D352,117 S * 11/1994 Taylor D25/16

OTHER PUBLICATIONS

Tim Skinner, DXB launches private sleeping pods, May 31, 2017, Time Out Dubai, <http://www.timeoutdubai.com/travel/news/77364-dxb-launches-private-sleeping-pods> (Year: 2017).*

* cited by examiner

Primary Examiner — Brett Miller

(57) **CLAIM**

The ornamental design for a shelter, as shown and described.

DESCRIPTION

FIG. 1 is a perspective view of a shelter showing our new design;
FIG. 2 is the front view of the shelter of FIG. 1;
FIG. 3 is the back view of the shelter of FIG. 1;
FIG. 4 is the top view of the shelter of FIG. 1;
FIG. 5 is the right side view of the shelter of FIG. 1;
FIG. 6 is the left side view of the shelter of FIG. 1; and,
FIG. 7 is the bottom view of the shelter of FIG. 1.
The broken lines depict portions of the shelter that form no part of the claim.

1 Claim, 7 Drawing Sheets

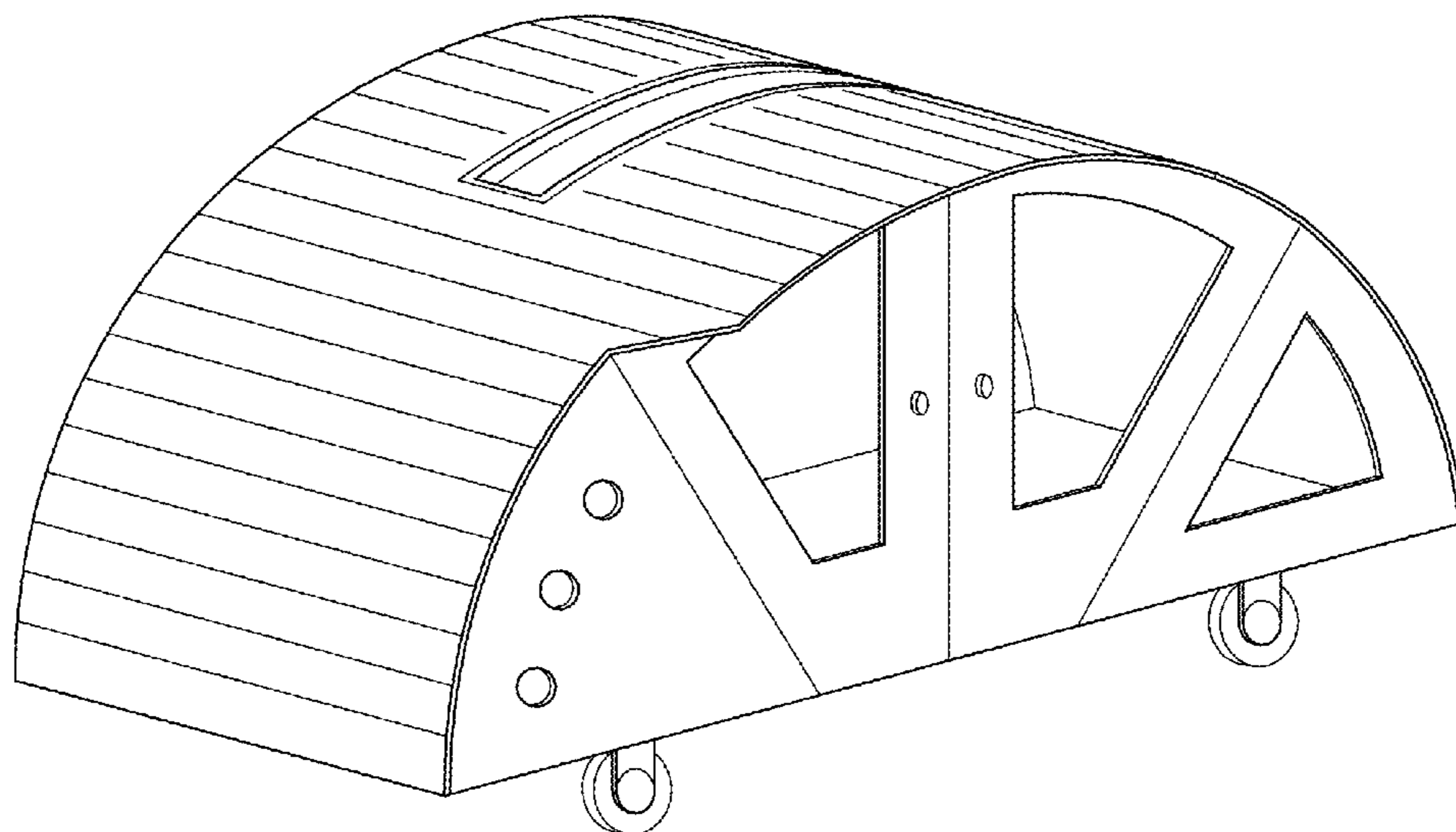

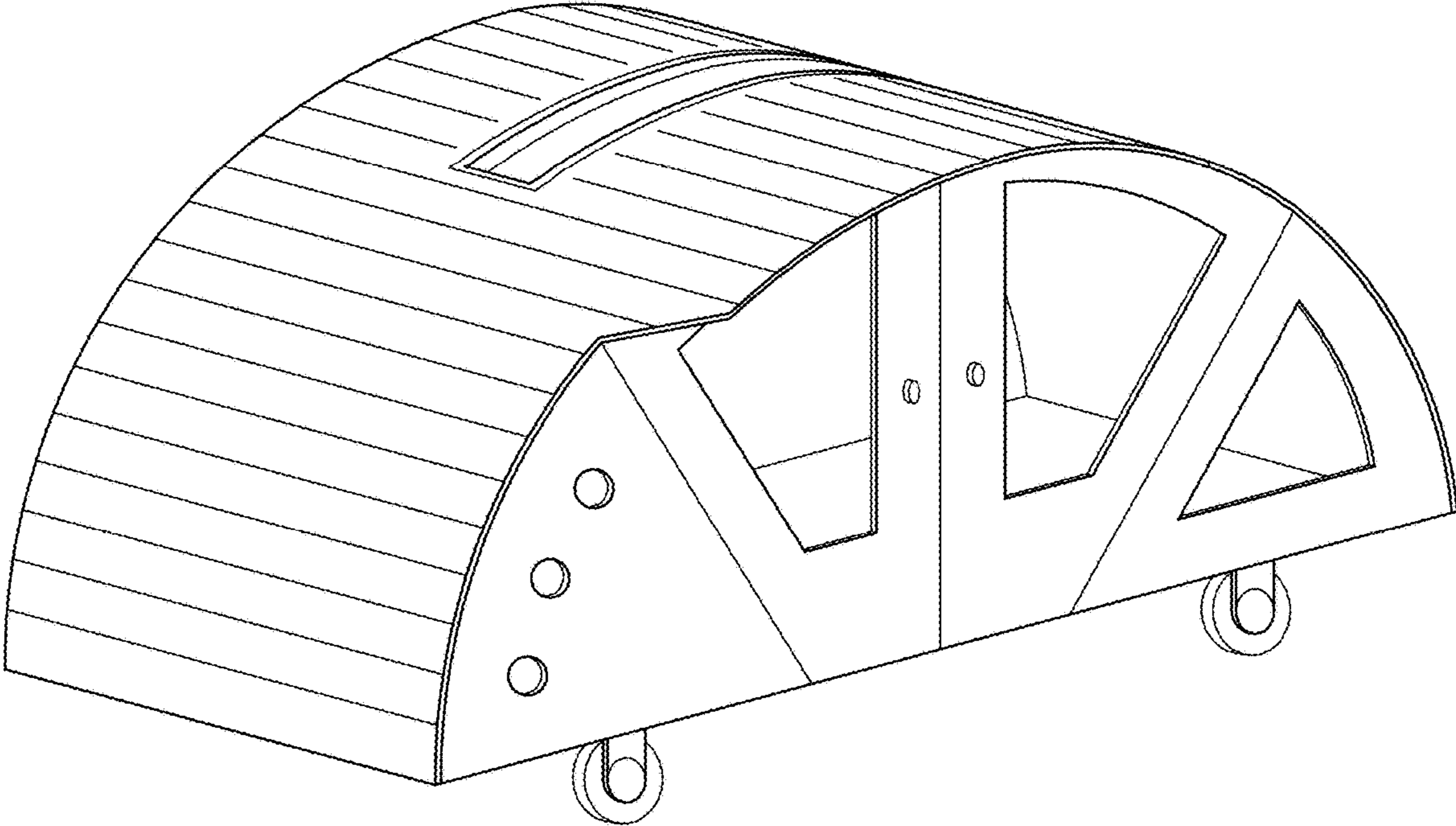

FIG. 1

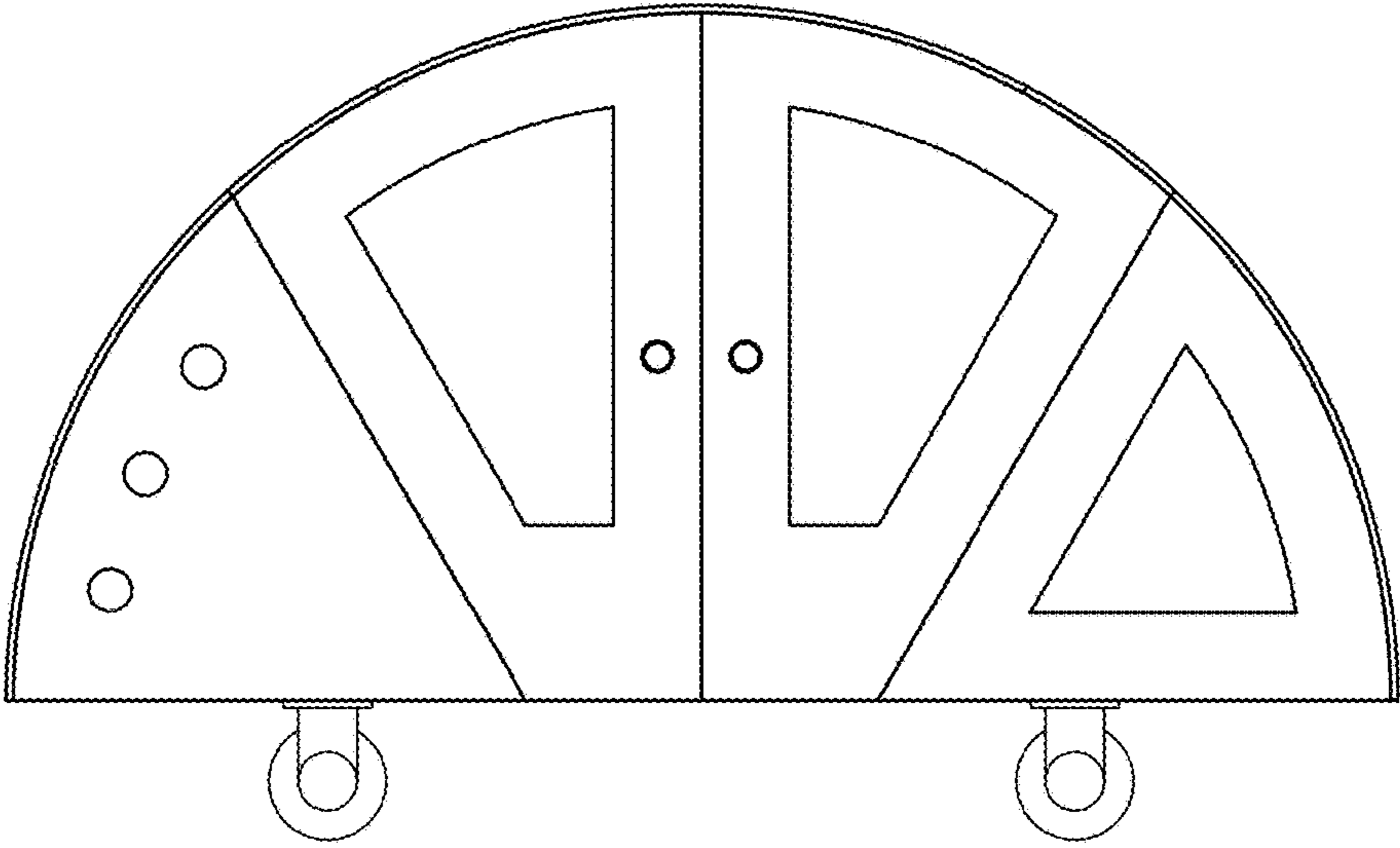

FIG. 2

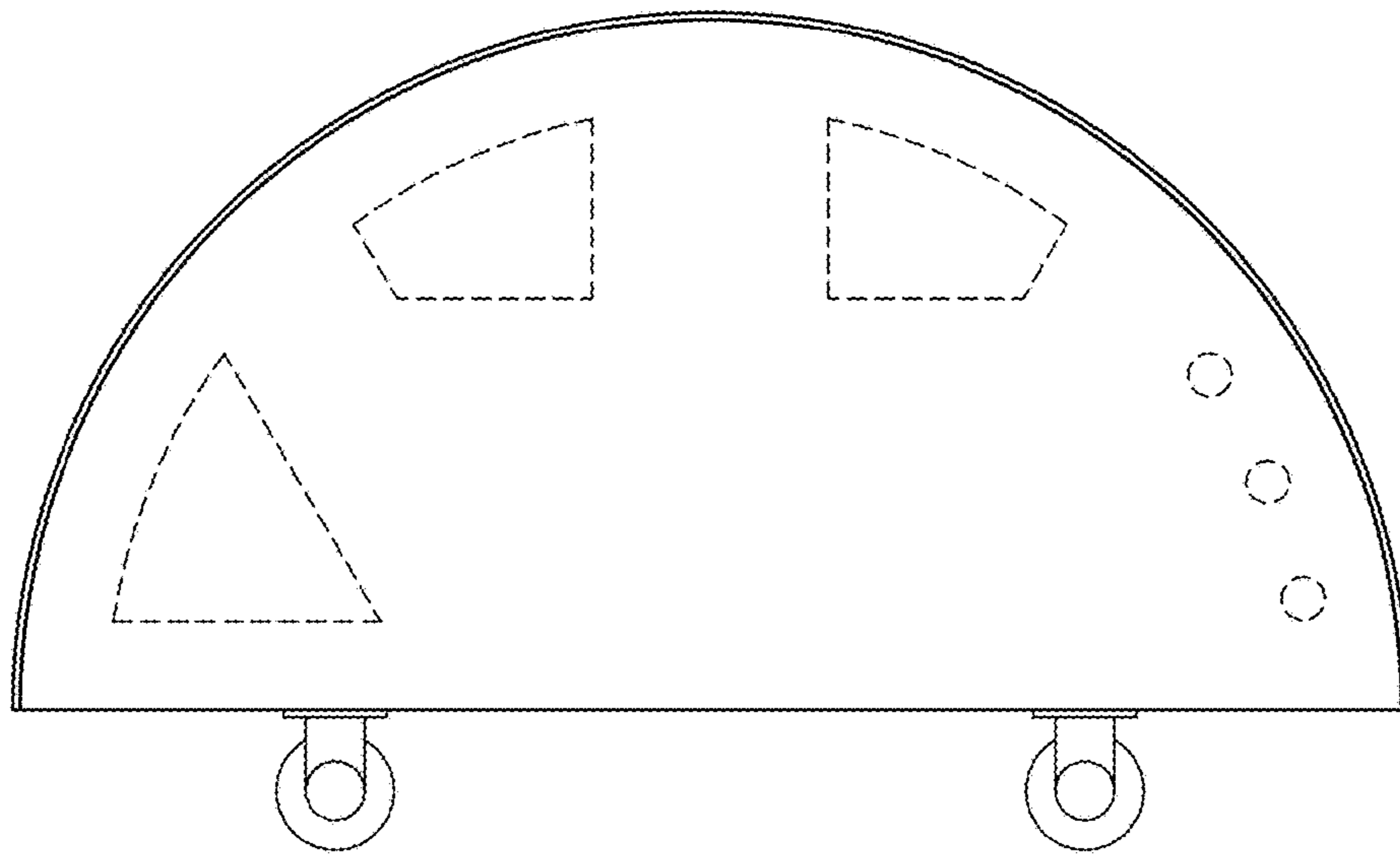

FIG. 3

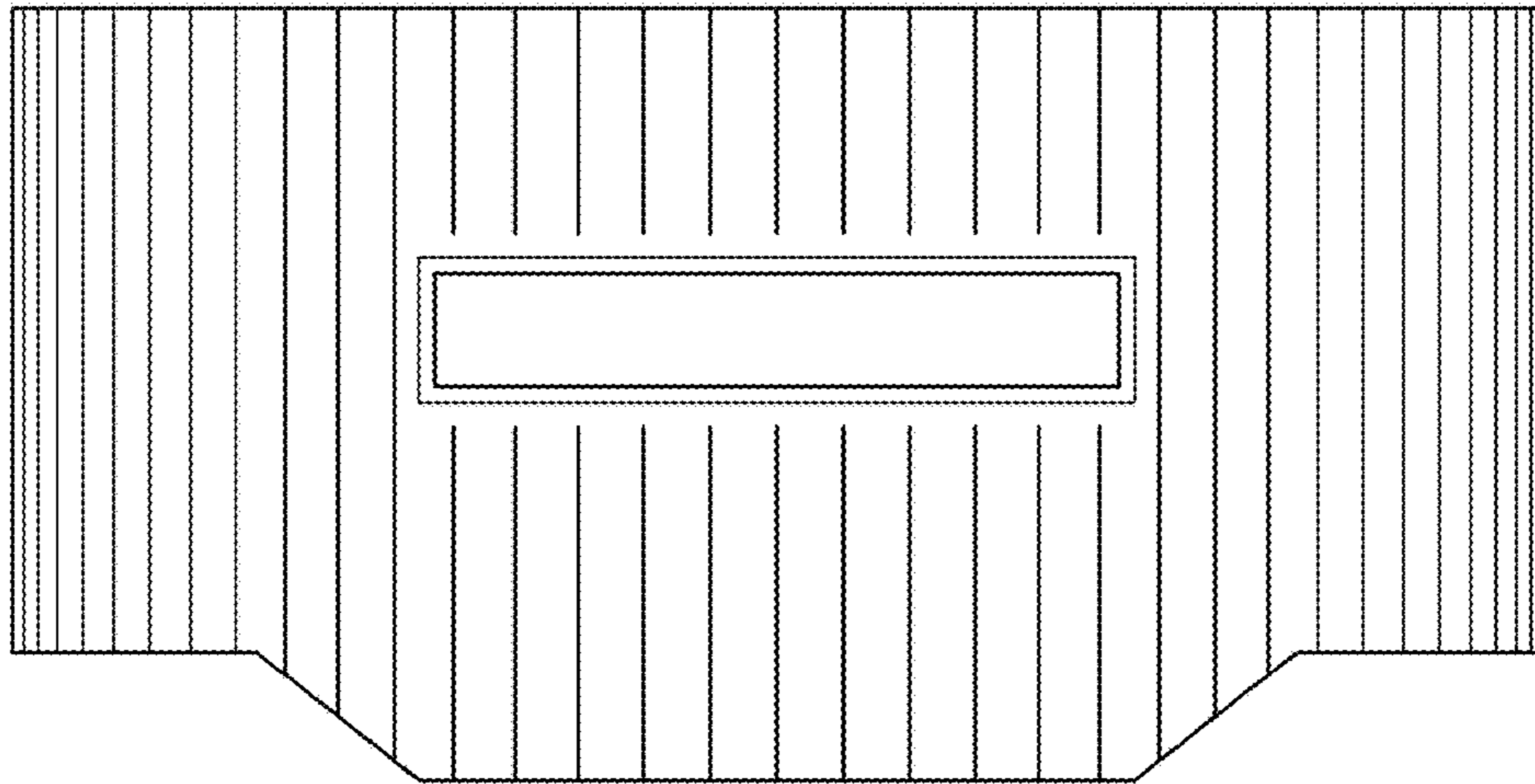

FIG. 4

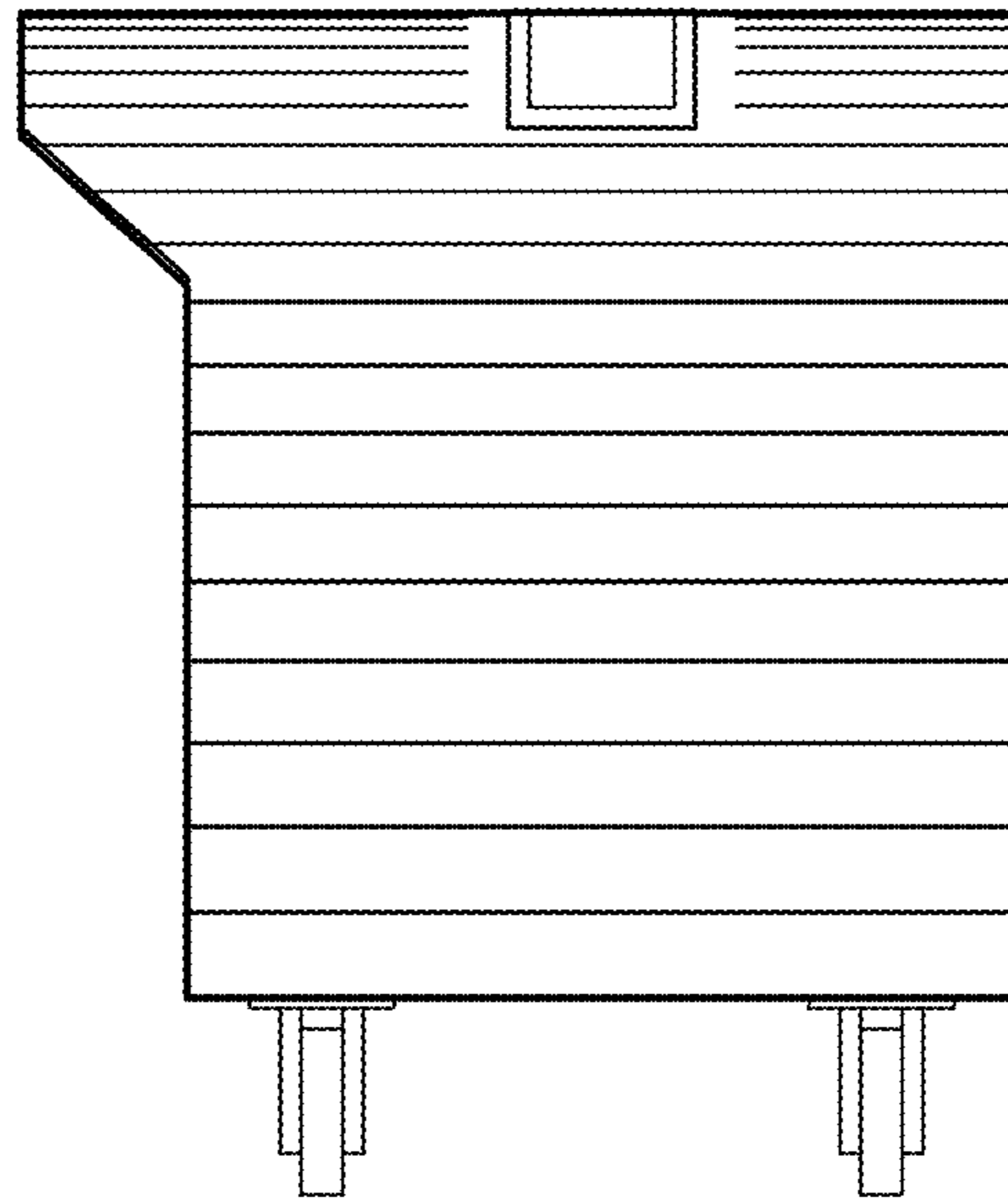

FIG. 5

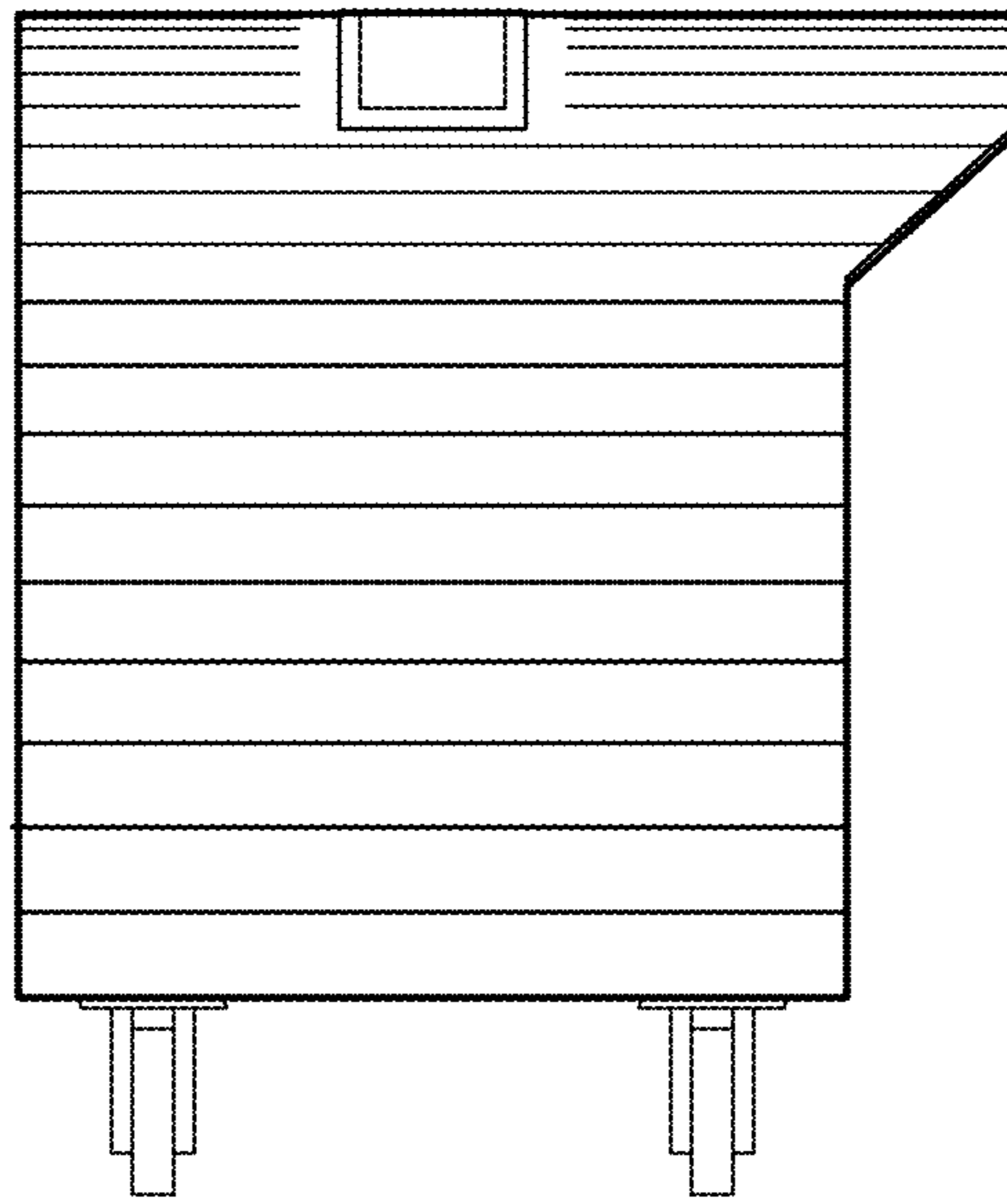

FIG. 6

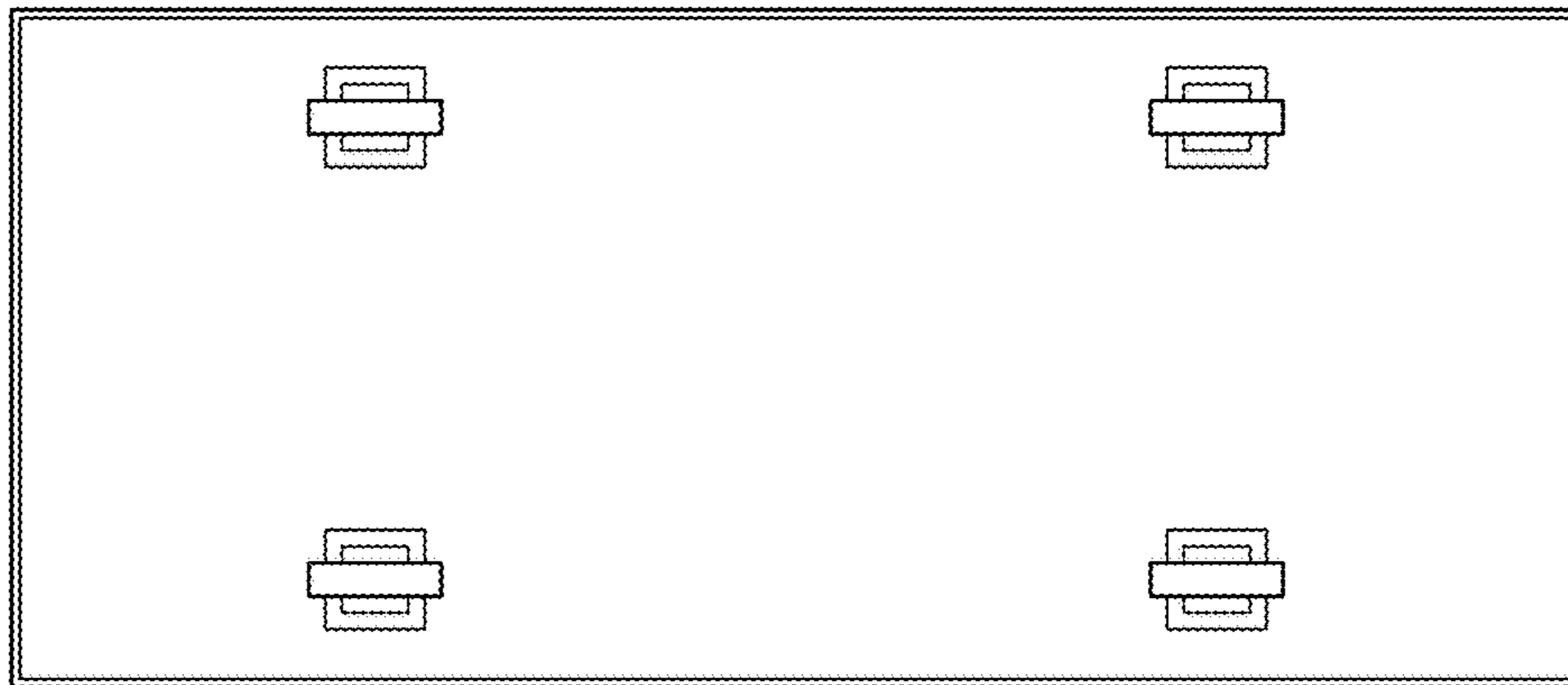

FIG. 7