



US00D844693S

(12) **United States Design Patent**
Kiesel

(10) **Patent No.:** **US D844,693 S**

(45) **Date of Patent:** **** Apr. 2, 2019**

(54) **GUITAR BODY**

(71) Applicant: **Jeff Kiesel**, Escondido, CA (US)

(72) Inventor: **Jeff Kiesel**, Escondido, CA (US)

(**) Term: **15 Years**

(21) Appl. No.: **29/632,073**

(22) Filed: **Jan. 4, 2018**

(51) **LOC (11) Cl.** **17-03**

(52) **U.S. Cl.**
USPC **D17/20**

(58) **Field of Classification Search**

USPC D17/14, 15, 17, 18, 19, 20, 21; D21/405,
D21/406, 411

CPC G10D 1/00; G10D 1/08; G10D 1/085;
G10D 3/00; G10D 3/12

See application file for complete search history.

(56) **References Cited**

U.S. PATENT DOCUMENTS

D239,052 S *	3/1976	Bolen	D17/14
D269,524 S *	6/1983	Burge	D17/14
D270,842 S *	10/1983	Peavey	D17/14
D335,890 S *	5/1993	Riboloff	D17/20
D349,721 S *	8/1994	Riboloff	D17/20
D410,943 S *	6/1999	Alvarado	D17/20
D496,388 S *	9/2004	Butler	D17/20
D516,607 S *	3/2006	Dawson	D17/20
D593,147 S *	5/2009	Kirkland	D17/14
D624,581 S *	9/2010	Guinn	D17/14
D767,017 S *	9/2016	Nash	D17/20

FOREIGN PATENT DOCUMENTS

GB 3011952 * 3/2003

OTHER PUBLICATIONS

Premier Guitars, Weird Guitars: Vintage Freak Show, posted Jun. 5, 2014, [online], [site visited Nov. 1, 2018]. Available from Internet,

<URL: <https://www.premierguitar.com/articles/20875-weird-guitars-vintage-freak-show?page=7>> (Year: 2014).*

Gear Couch, Kiesel Guitars Aries A6H Review & Video, posted Nov. 9, 2015, [online], [site visited Nov. 1, 2018]. Available from Internet, <URL: <https://gearcouch.com/2015/11/09/kiesel-guitars-aries-a6h-review-video/>> (Year: 2015).*

Conklin Guitars, Conklin Custom Shop 6 String Guitar, webarchive May 31, 2012, [online], [site visited Nov. 1, 2018]. Available from Internet, <URL: https://web.archive.org/web/20120531030922/http://www.conklinguitars.com/custom_6_string_guitar_walnut_custom_inlay.html> (Year: 2012).*

* cited by examiner

Primary Examiner — Sheryl Lane

Assistant Examiner — Samantha N Wood

(74) *Attorney, Agent, or Firm* — Plager Schack LLP;
Mark H. Plager

(57) **CLAIM**

An ornamental design for a guitar body, as shown and described.

DESCRIPTION

FIG. 1 is a perspective view of the guitar body.
FIG. 2 is a frontal perspective view of the guitar body.
FIG. 3 is a rear perspective view of the guitar body.
FIG. 4 is a left lateral view of the guitar body.
FIG. 5 is a right lateral view of the guitar body.
FIG. 6 is a top view of the guitar body; and,
FIG. 7 is a bottom view of the guitar body.

The broken lines are included for the purpose of illustrating portions of the guitar body and form no part of the claimed design.

1 Claim, 5 Drawing Sheets

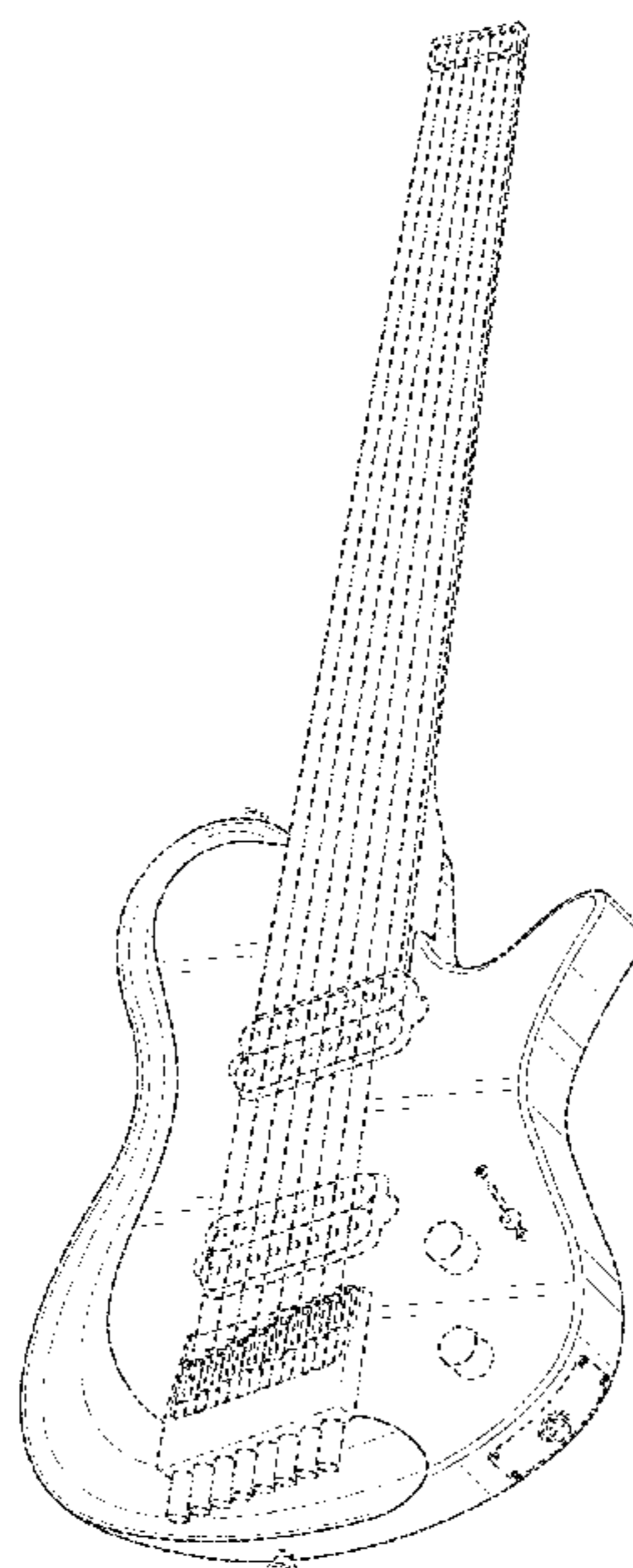

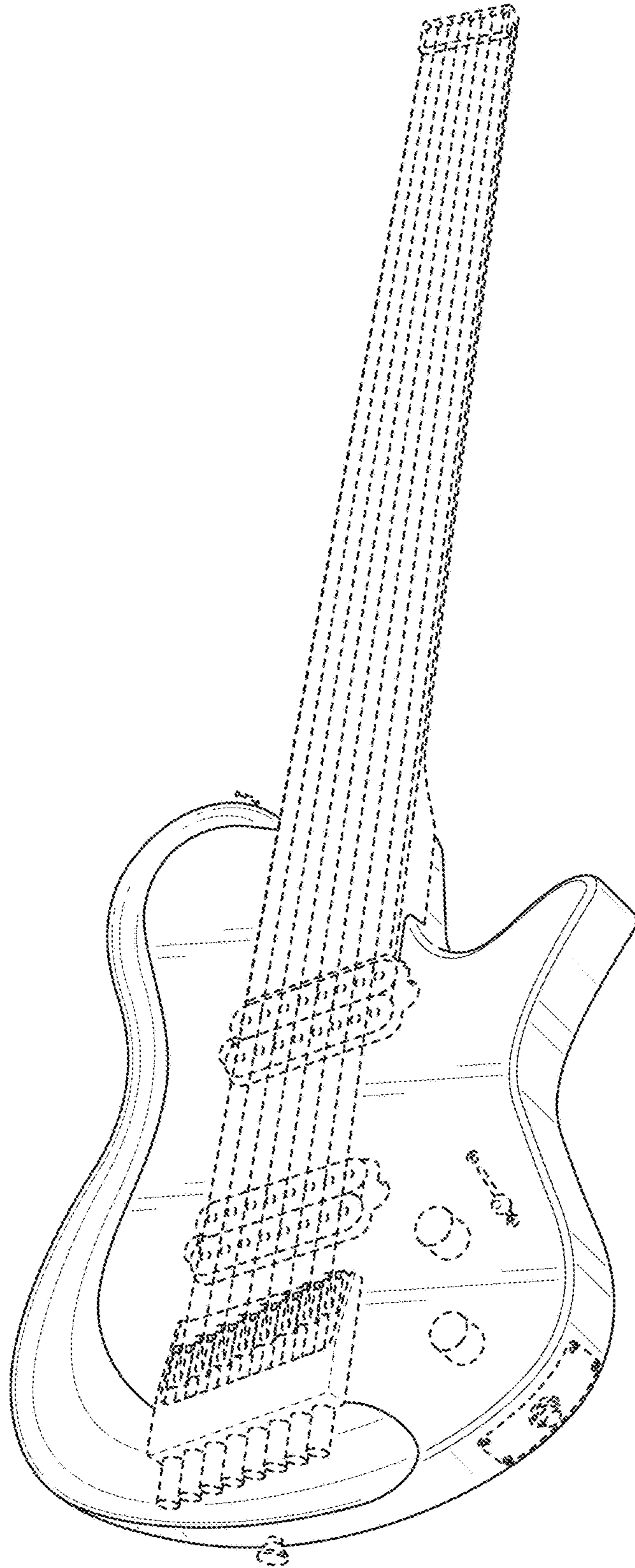

FIG. 1

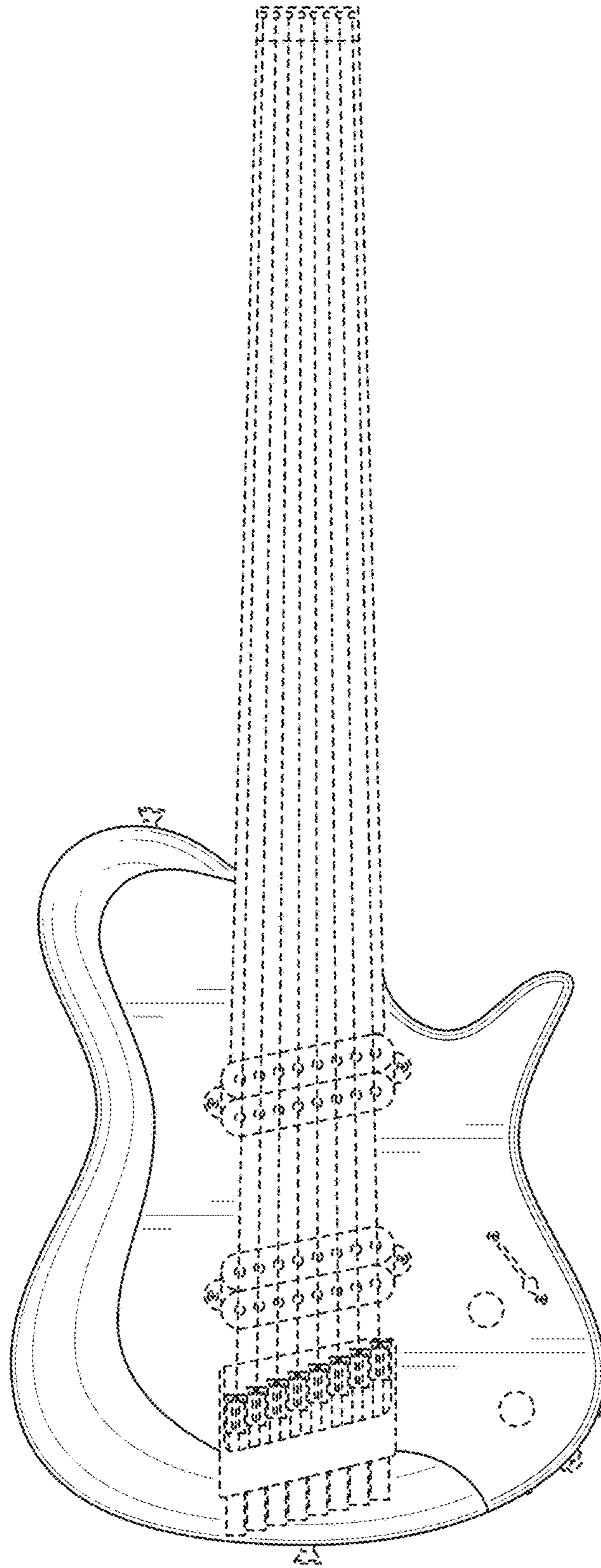

FIG. 2

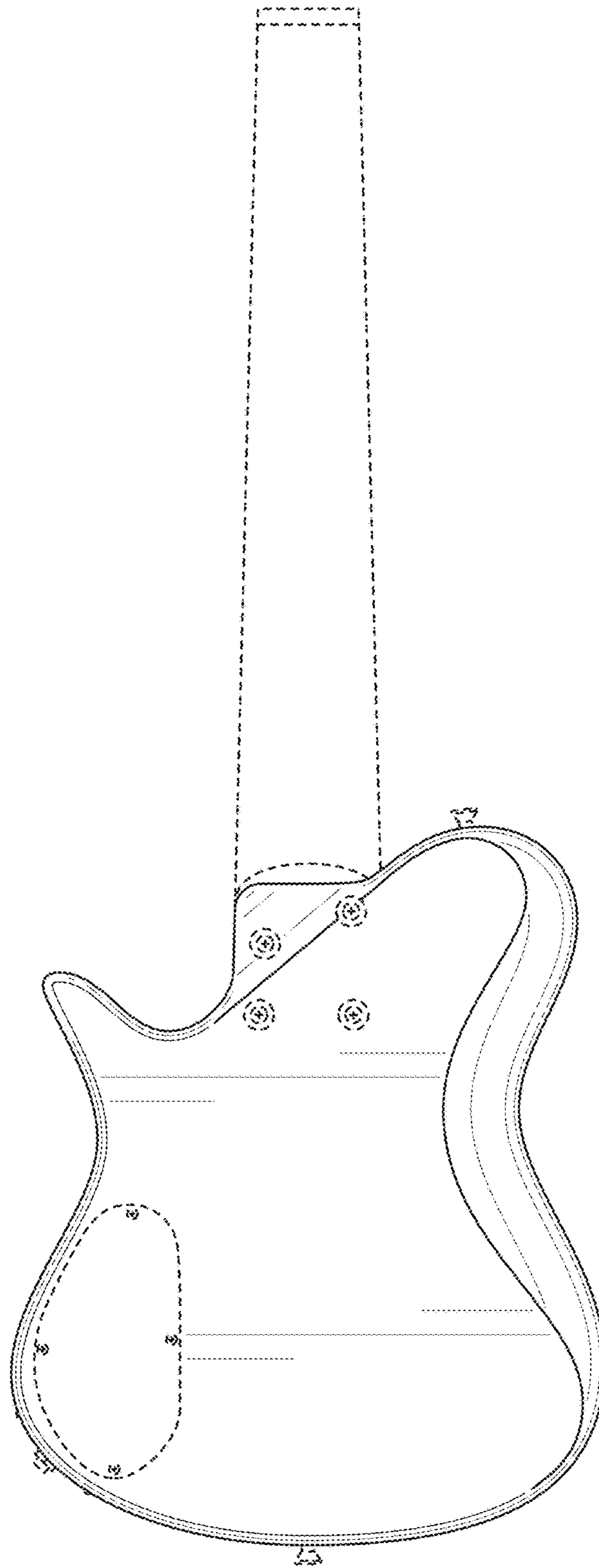

FIG. 3

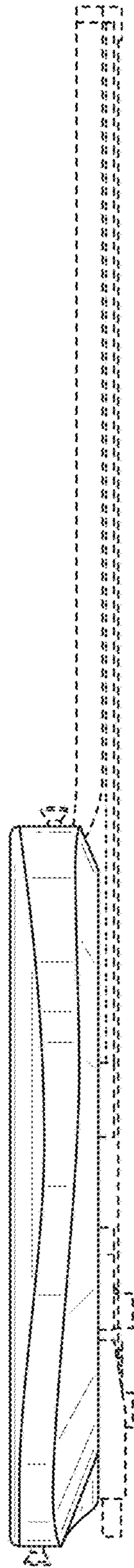

FIG. 4



FIG. 5

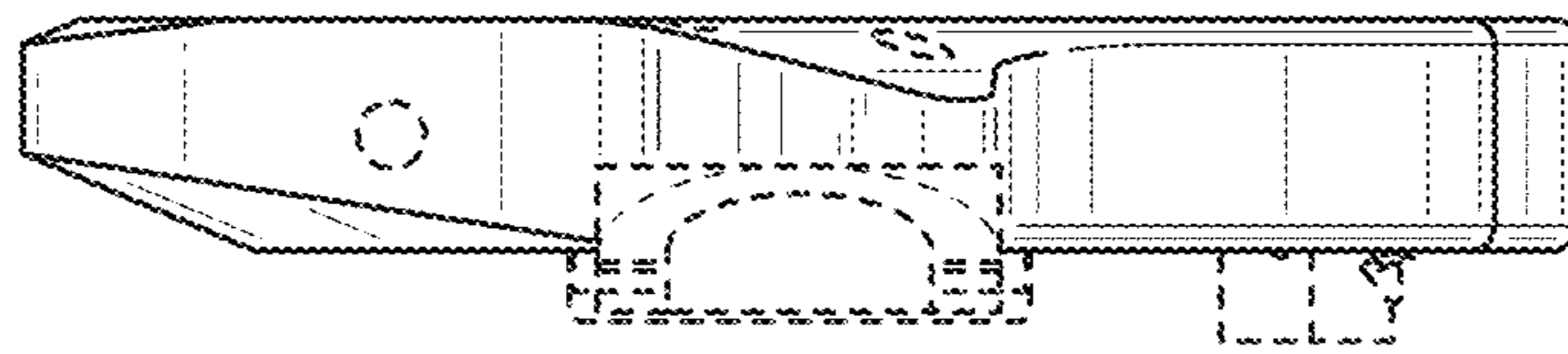

FIG. 6

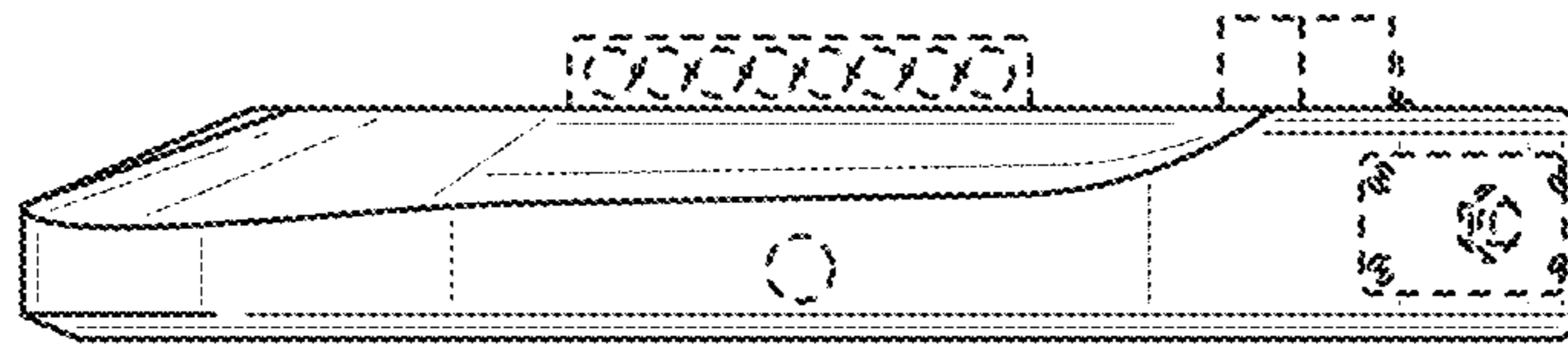

FIG. 7