



US00D844554S

(12) **United States Design Patent**
Franklin

(10) **Patent No.:** **US D844,554 S**

(45) **Date of Patent:** **** Apr. 2, 2019**

(54) **PHOTOVOLTAIC PANEL SUPPORT**

(71) Applicant: **LUMOS SOLAR, LLC**, Nederland,
CO (US)

(72) Inventor: **Scott Franklin**, Nederland, CO (US)

(73) Assignee: **LUMOS SOLAR, LLC**, Nederland,
CO (US)

(**) Term: **15 Years**

(21) Appl. No.: **29/638,364**

(22) Filed: **Feb. 27, 2018**

(51) **LOC (11) Cl.** **13-02**

(52) **U.S. Cl.**
USPC **D13/102**

(58) **Field of Classification Search**
USPC D13/101, 102, 103, 104, 105, 106, 118,
D13/184, 199
CPC H01L 31/00; H01L 31/02; H01L 31/042;
H01L 31/045; H01L 31/046; H01L
31/048; H01L 31/05; H01L 31/052; H01L
31/0525; H02S 30/00; H02S 20/10; H02S
20/23; H02S 20/30; H02S 40/34; H02S
40/44; H02S 30/10; F24J 2/52; F03G
6/00

See application file for complete search history.

(56) **References Cited**

U.S. PATENT DOCUMENTS

D511,576 S * 11/2005 Shingleton D25/56
D633,033 S * 2/2011 Conger F24S 25/50
D13/102
D649,112 S * 11/2011 Conger F24S 25/50
D13/102
D658,120 S * 4/2012 Kawai D13/102

D672,472 S * 12/2012 Dolceamore F24S 25/12
D25/22
D734,870 S * 7/2015 Scorsonne D25/22
D754,064 S * 4/2016 Mackler D13/102
2011/0240093 A1* 10/2011 Tucker F24S 25/65
136/245
2017/0331414 A1* 11/2017 Bailey H02S 20/10

* cited by examiner

Primary Examiner — Daniel D Bui

(74) *Attorney, Agent, or Firm* — Hoffmann and Baron,
LLP

(57) **CLAIM**

The ornamental design for a photovoltaic panel support, as shown and described.

DESCRIPTION

FIG. 1 is a top perspective view of a photovoltaic panel support, showing my new design; FIG. 2 is a front elevational view thereof; FIG. 3 is a left side elevational view thereof, FIG. 4 is the right side elevational view thereof; FIG. 5 is a back elevational view thereof; FIG. 6 is a top plan view thereof; and FIG. 7 is a bottom elevational view thereof. FIG. 8 is a top perspective view thereof, in use condition; FIG. 9 is a bottom perspective view thereof, in use condition; and, FIG. 10 is another top perspective view thereof, in use condition.

The broken line shown in the drawing views is for the purpose of illustrating unclaimed environment only and forms no part of the claimed design. The bolts and nuts shown in the various views form no part of the claimed design.

1 Claim, 10 Drawing Sheets

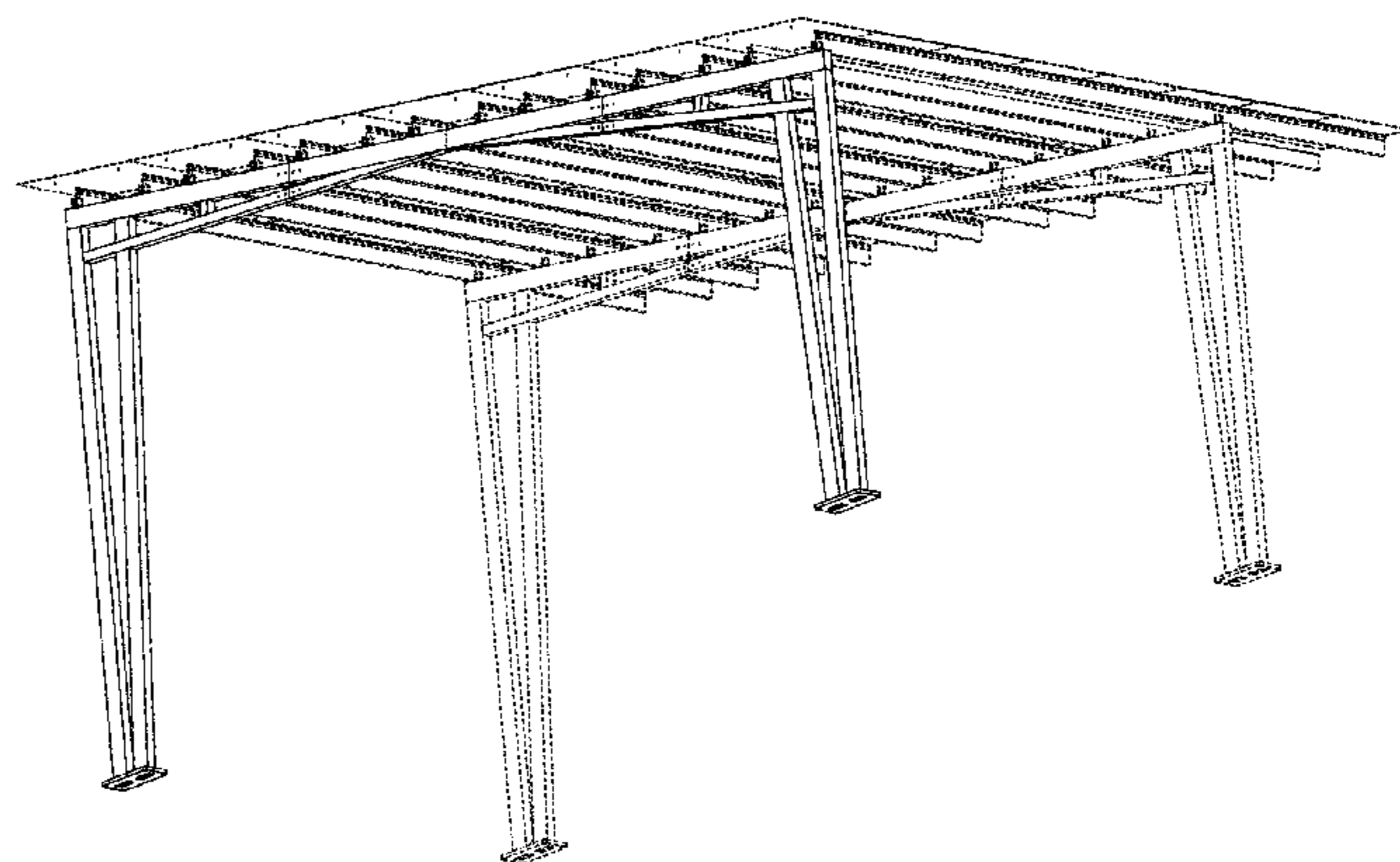
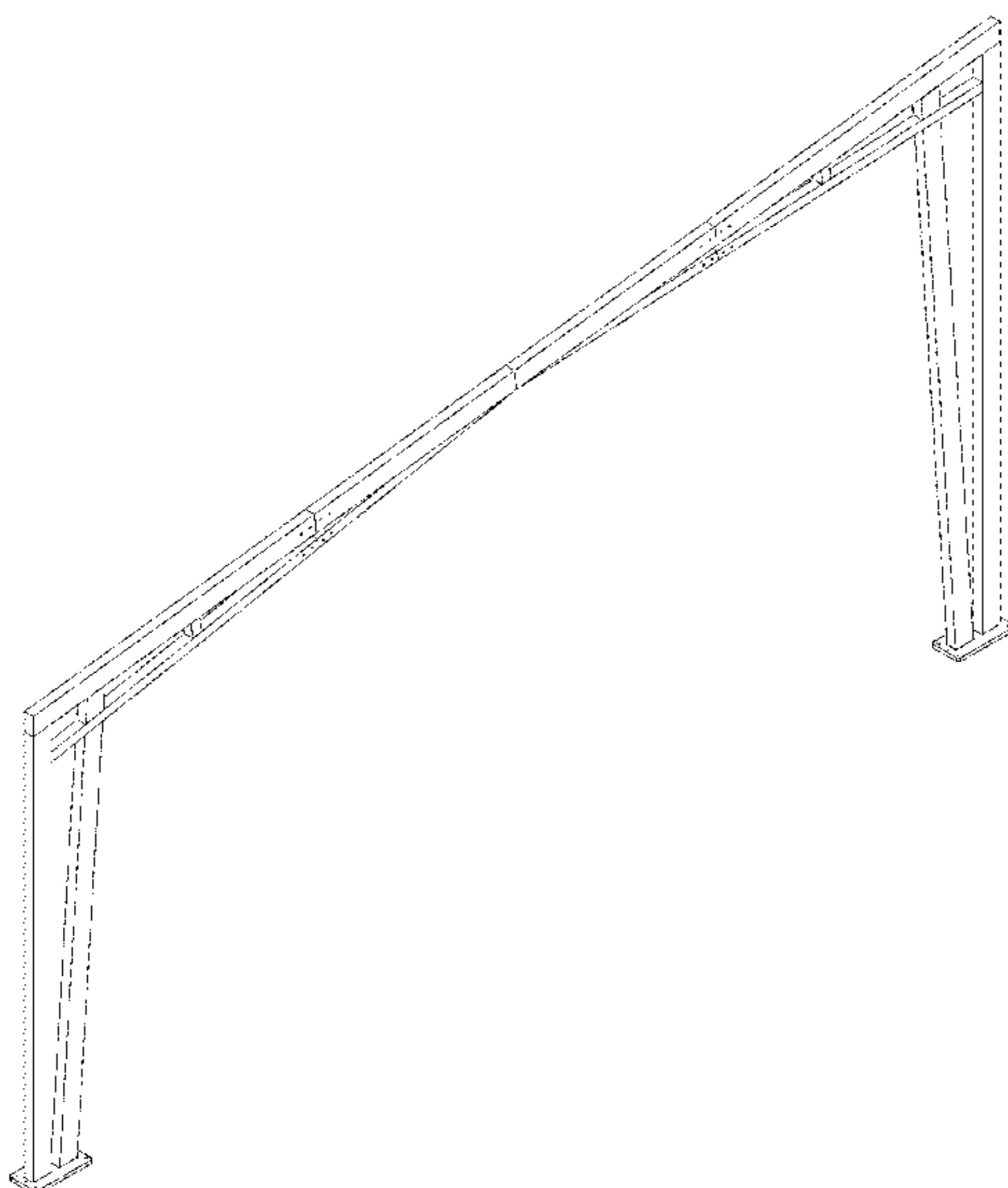

FIG 1

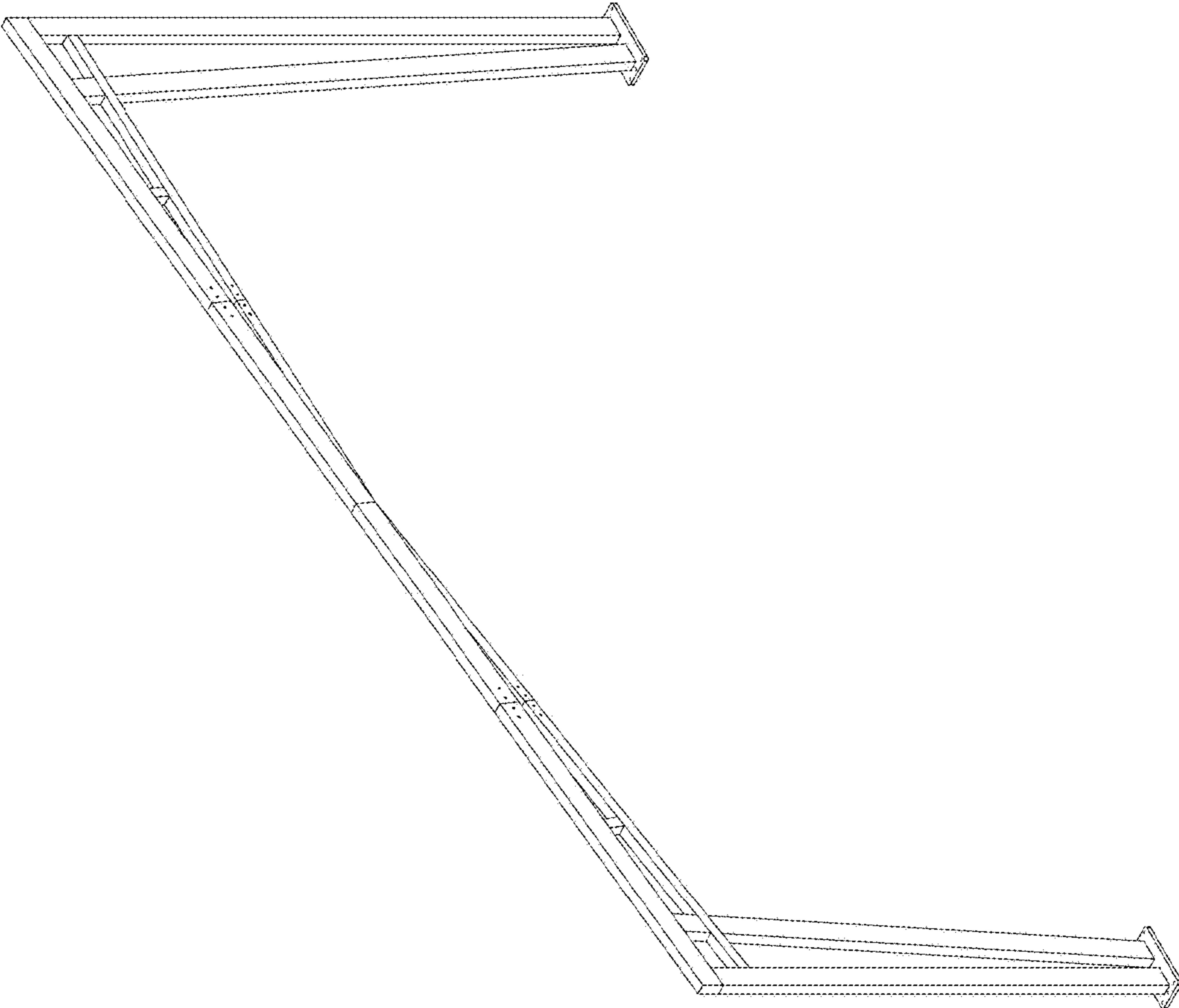
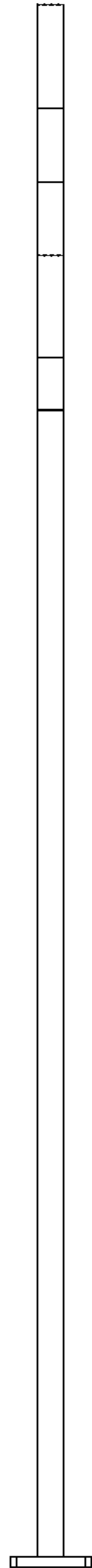

FIG 2



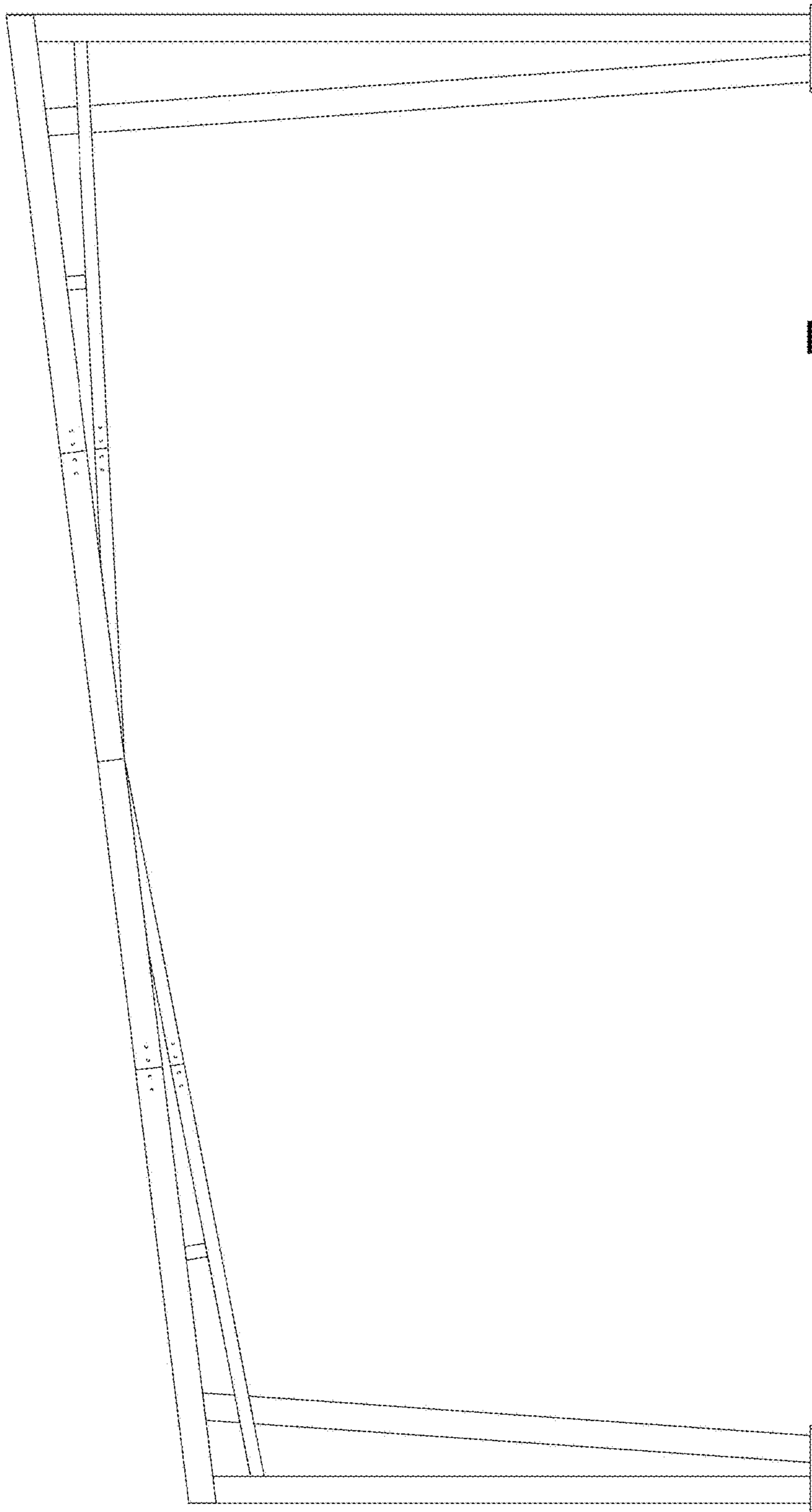

FIG 3

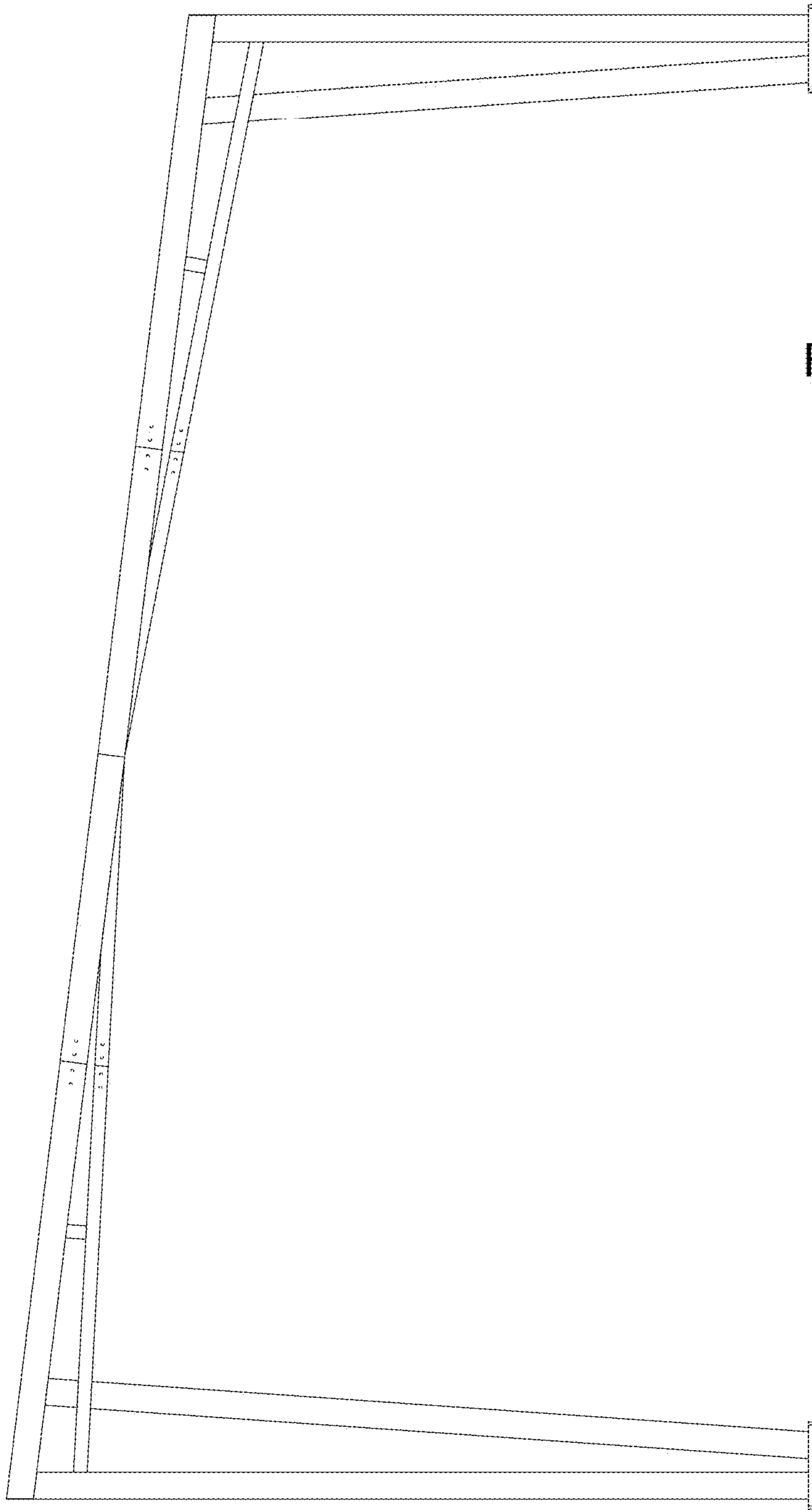

FIG 4

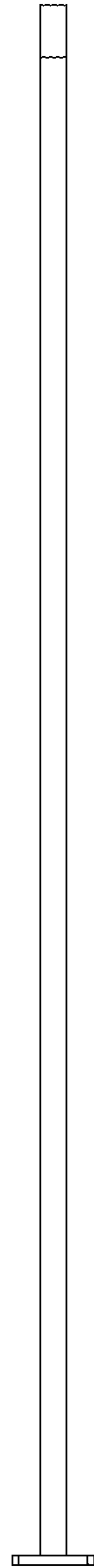

FIG 5

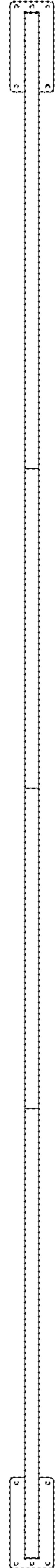

FIG 6

FIG 7

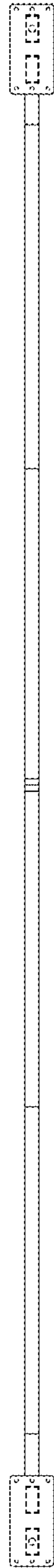

FIG 8

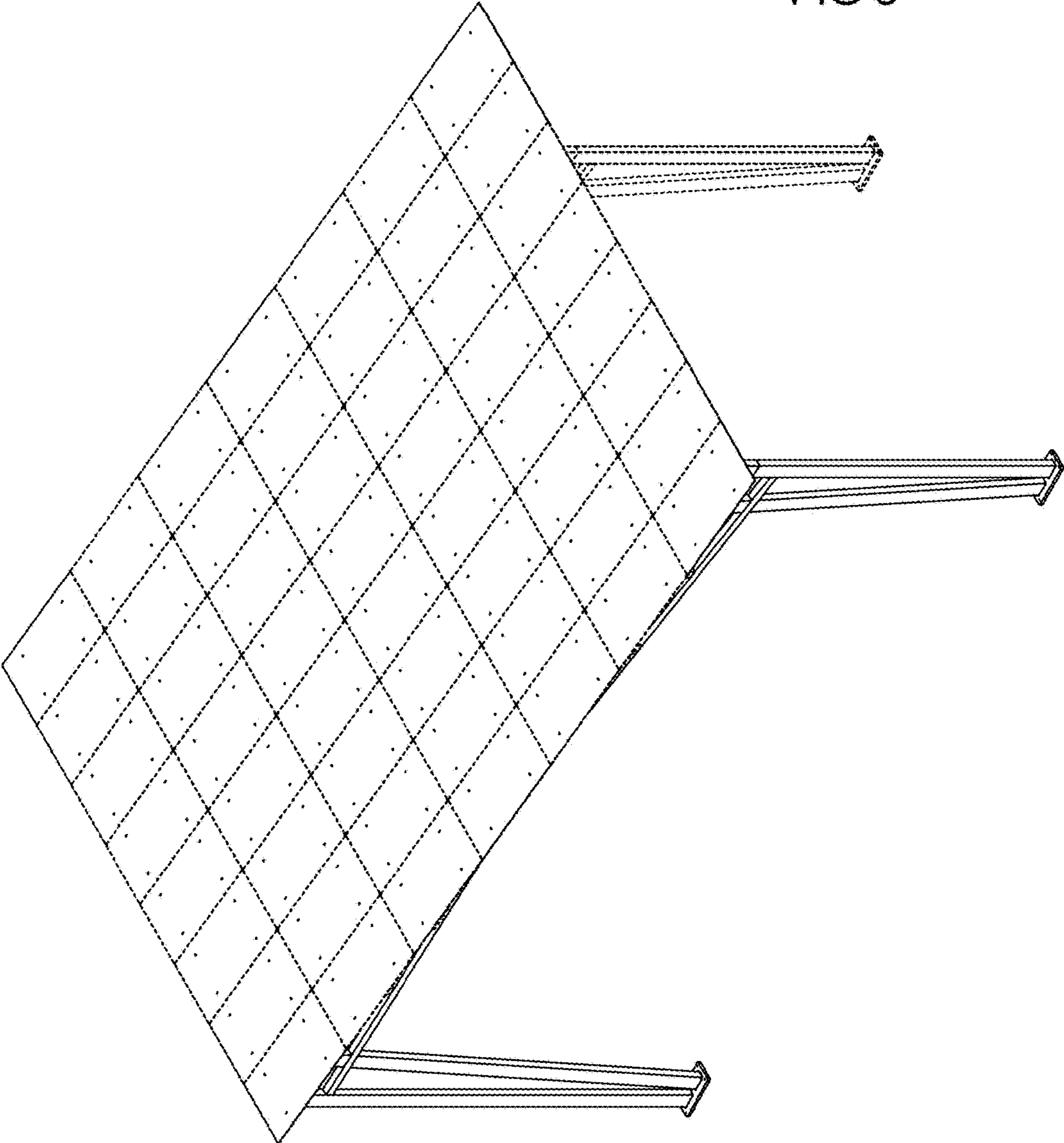

FIG 9

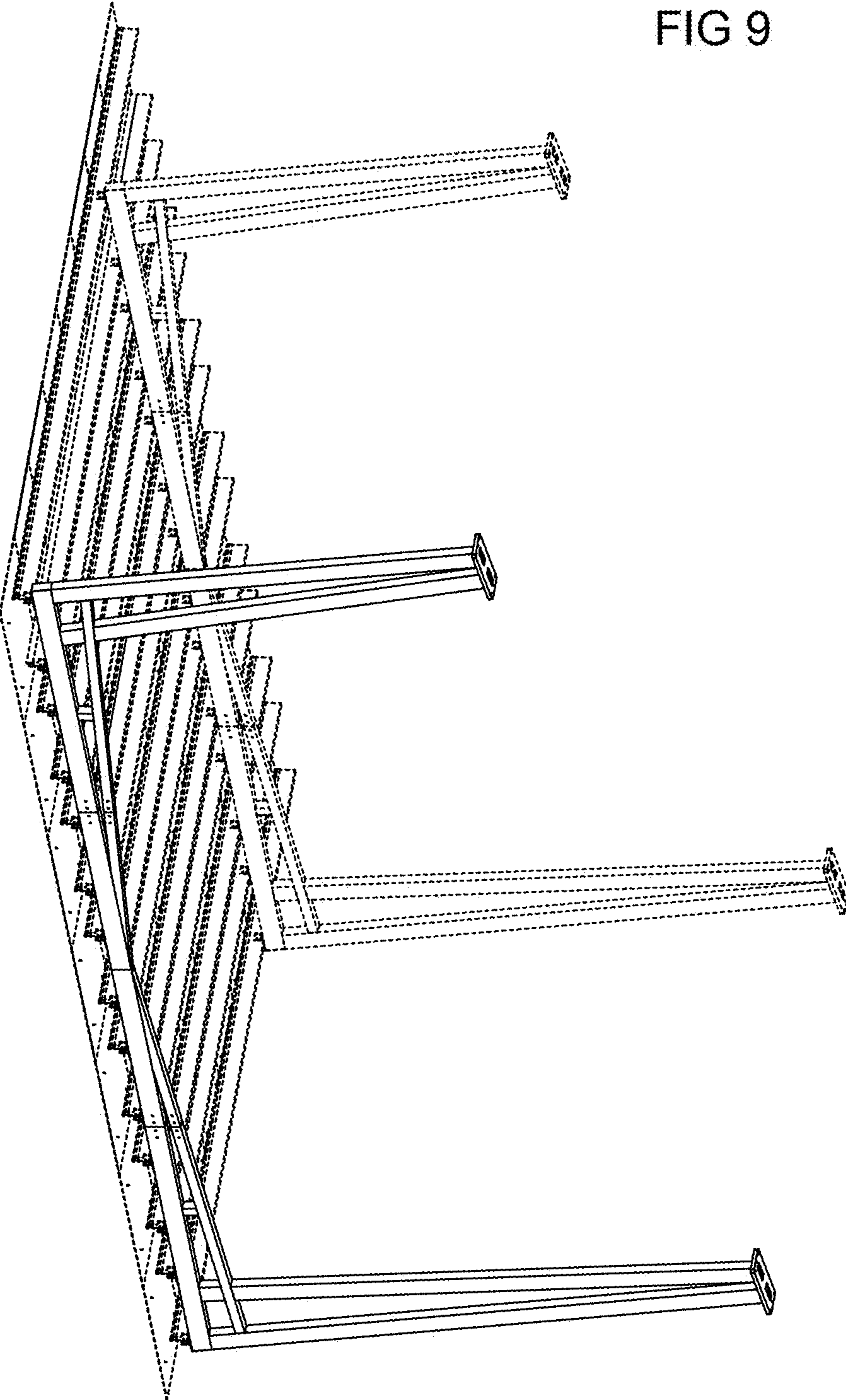

FIG 10

