



US00D844514S

(12) **United States Design Patent** (10) **Patent No.:** **US D844,514 S**
Wagner et al. (45) **Date of Patent:** **** Apr. 2, 2019**

(54) **MULTI-FUNCTIONAL JOYSTICK FOR AN AGRICULTURAL VEHICLE**
(71) Applicant: **Deere & Company**, Moline, IL (US)
(72) Inventors: **Christoph Wagner**, Reilingen (DE);
Sebastian Himpel, Mannheim (DE);
Thorsten Hagner, Ilvesheim (DE);
Nicolas Staack, Heddesheim (DE);
Jonathan E. Drum, Raleigh, NC (US)

D536,153 S * 1/2007 Niebuhr D14/415
D571,268 S * 6/2008 Hoffman D12/179
7,497,298 B2 * 3/2009 Shearer E02F 3/7663
180/333
D595,744 S * 7/2009 Umeda D15/28
D606,100 S * 12/2009 Kobayashi D15/28
D606,567 S * 12/2009 Kobayashi D15/28
7,641,019 B2 * 1/2010 Pline B60K 26/02
180/315
D640,258 S * 6/2011 Hobenshield D14/412
D656,073 S * 3/2012 Foerster D12/179
(Continued)

(73) Assignee: **DEERE & COMPANY**, Moline, IL (US)

(**) Term: **15 Years**

(21) Appl. No.: **29/634,510**

(22) Filed: **Jan. 23, 2018**

(30) **Foreign Application Priority Data**

Jul. 26, 2017 (EM) 004121028

(51) **LOC (11) Cl.** **12-16**

(52) **U.S. Cl.**
USPC **D12/179**

(58) **Field of Classification Search**
USPC D12/7, 114, 126, 159, 174, 177, 179,
D12/180, 192, 195, 215, 223, 345, 400,
D12/415, 421, 568

CPC A61M 21/00; B60L 15/20; B60R 11/0264;
B64C 13/04; B64C 13/503; B64C 27/56;
B64D 11/0689; B66C 13/56; G05G 1/06;
G05G 1/105; G06F 3/0362; G06F 3/0482;
G06F 3/04847; G09F 13/04; G09F 13/08;
H03J 5/0272; H04B 1/405; H05K 11/02

See application file for complete search history.

(56) **References Cited**

U.S. PATENT DOCUMENTS

4,702,520 A * 10/1987 Whisler B60N 2/767
297/411.36
D463,459 S * 9/2002 Tamaru D15/28

OTHER PUBLICATIONS

Gear selector in the 2015 Jeep Grand Cherokee, image post date Jun. 22, 2016, site visited Aug. 1, 2018, (online), <<https://money.cnn.com/2016/06/22/autos/jeep-chrysler-shifter-recall-fix/index.html>>.*

(Continued)

Primary Examiner — Kevin K Rudzinski

(57) **CLAIM**

The ornamental design for a multi-functional joystick for an agricultural vehicle, as shown and described.

DESCRIPTION

FIG. 1 is a perspective view of a multi-functional joystick for an agricultural vehicle embodying our new design;
FIG. 2 is a left side view thereof;
FIG. 3 is a right side view thereof;
FIG. 4 is a front view thereof;
FIG. 5 is a rear view thereof;
FIG. 6 is a top view thereof; and,
FIG. 7 is a bottom view thereof.

The broken line representations in the figures show unclaimed environment or boundaries, and thus form no part of the claimed design.

1 Claim, 7 Drawing Sheets

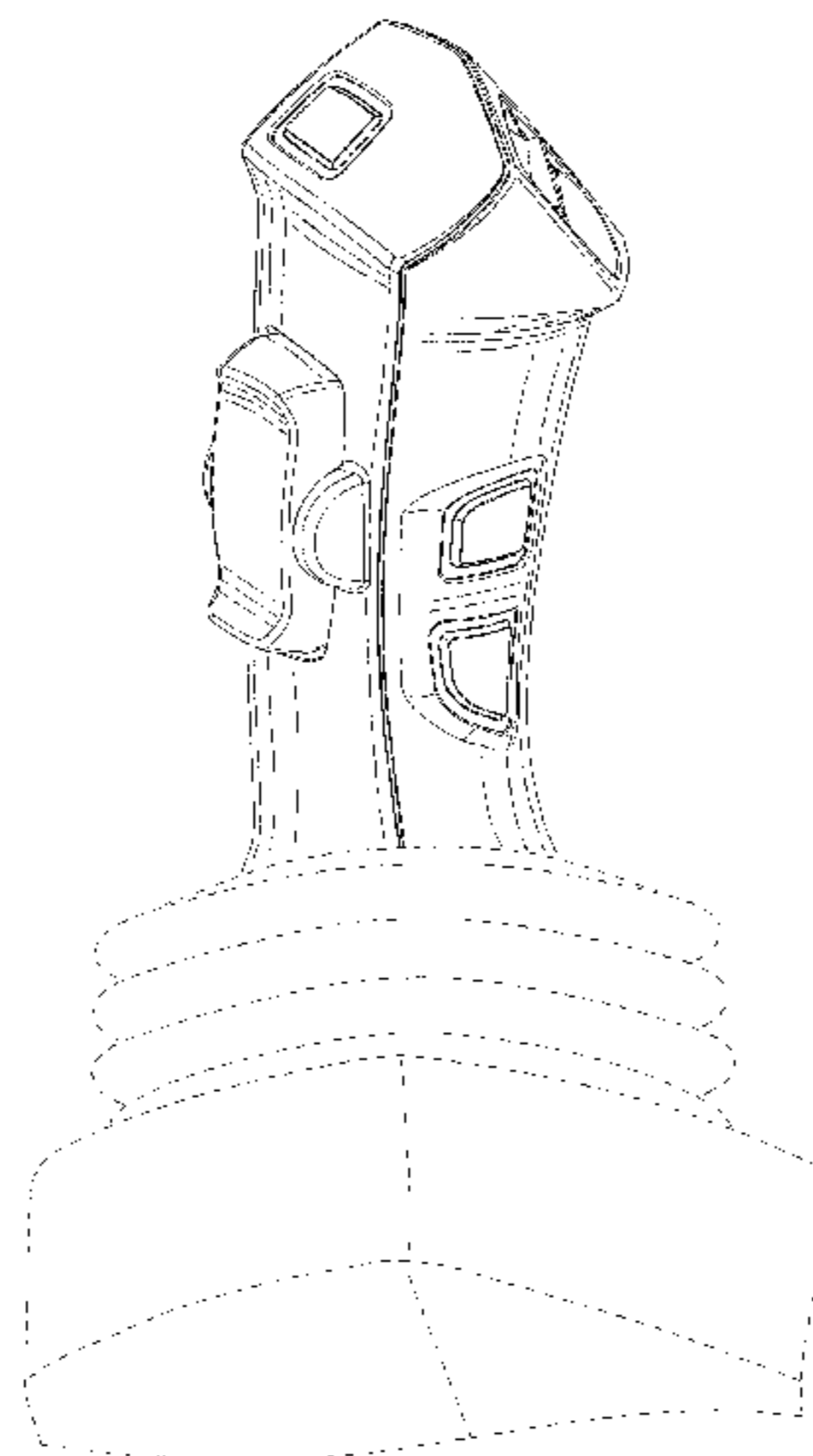

(56)

References Cited

U.S. PATENT DOCUMENTS

D686,622 S * 7/2013 Rey D14/412
 D687,075 S * 7/2013 Richard D15/28
 D698,358 S * 1/2014 Beams D14/412
 8,714,049 B2 * 5/2014 Ast G05G 1/04
 296/1.09
 D709,102 S * 7/2014 Tokuda D15/28
 8,807,635 B2 * 8/2014 Taylor B60N 3/06
 296/190.08
 D722,415 S * 2/2015 Castagnola D34/31
 D723,033 S * 2/2015 Hooek D14/412
 D723,559 S * 3/2015 Hein D14/413
 D725,681 S * 3/2015 Bonneau D15/28
 D727,904 S * 4/2015 Jensen D14/415
 D731,487 S * 6/2015 Matloff D14/412
 9,058,051 B2 * 6/2015 Miura G05G 1/06
 D741,863 S * 10/2015 Hooek D14/413
 D745,008 S * 12/2015 Jensen D14/415
 D745,009 S * 12/2015 Jensen D14/415
 D747,721 S * 1/2016 Gentle D12/179
 D751,027 S * 3/2016 Kasparian D12/345
 D753,118 S * 4/2016 French D12/179
 D758,949 S * 6/2016 Tran D12/345
 D759,731 S * 6/2016 Roemer D15/28
 D765,079 S * 8/2016 Hooek D14/412
 D768,210 S * 10/2016 Jacobsthal D15/31
 D768,728 S * 10/2016 Okuyama D15/28
 D777,803 S * 1/2017 Wuisan D15/28
 D778,219 S * 2/2017 Choi D12/174
 D784,785 S * 4/2017 Sasaki D12/179
 D784,872 S * 4/2017 Kanatani D12/177
 D786,944 S * 5/2017 Okuyama D15/28
 D797,743 S * 9/2017 Awad D14/412

D800,183 S * 10/2017 Wuisan D15/28
 D800,784 S * 10/2017 Collins D15/5
 D801,974 S * 11/2017 Stadlbauer D14/415
 9,963,084 B2 * 5/2018 Jacobsthal A01D 41/12
 2010/0123345 A1 * 5/2010 Steege B60N 2/797
 297/411.2
 2011/0072934 A1 * 3/2011 Ulbrich G05G 1/06
 74/558.5
 2015/0101440 A1 * 4/2015 Bonneau G05G 1/01
 74/484 R
 2015/0128741 A1 * 5/2015 Farkas F16H 59/0278
 74/473.3
 2015/0253801 A1 * 9/2015 Wuisan G05G 1/06
 74/479.01
 2016/0229523 A1 * 8/2016 Scacchi B64C 13/04
 2018/0004310 A1 * 1/2018 Drum G06F 3/0338

OTHER PUBLICATIONS

Gear shifters from the New York Auto Show, image post date Apr. 20, 2017, site visited Jul. 30, 2018, (online), <<https://www.theverge.com/2017/4/20/15346160/gear-shifters-bmw-volvo-honda-ford-lexus-cadillac-new-york-international-auto-show>>.*
 Controllers of New holland t4.65 powerstar, image post date 2012, site visited Aug. 1, 2018, (online), <<http://www.affaretrattore.it/annunci/new-holland-t4-65-powerstar-364557.html>>.*
 Hand Controller of CX8.90 conventional combine harvester, image post date Nov. 10, 2015, site visited Aug. 1, 2018, (online), <<https://www.terre-net.fr/materiel-agricole/recolte-fenaison/article/avec-490-ch-la-cx8-90-devient-la-conventionnelle-la-plus-puissante-au-monde-208-114397.html>>.*

* cited by examiner

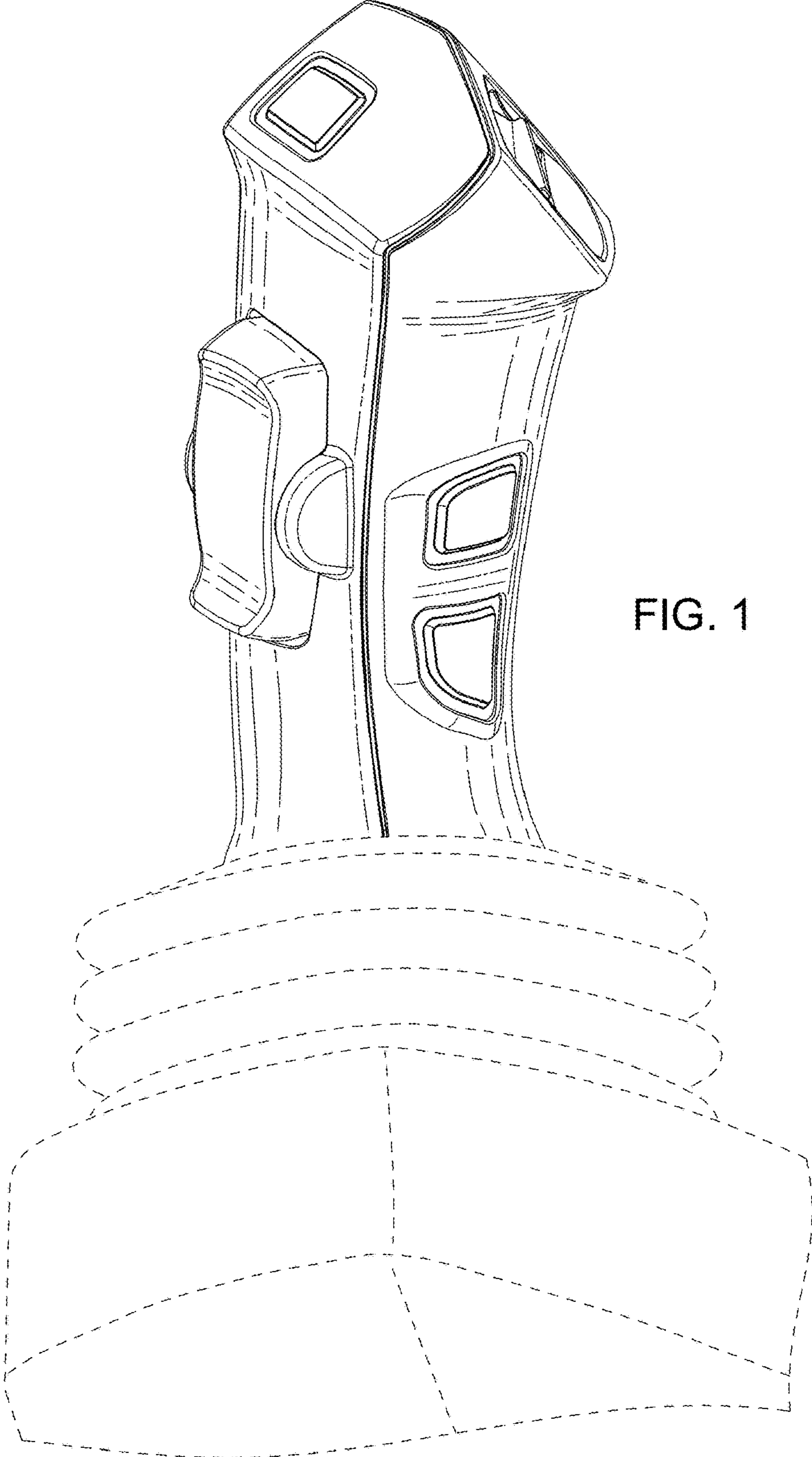

FIG. 1

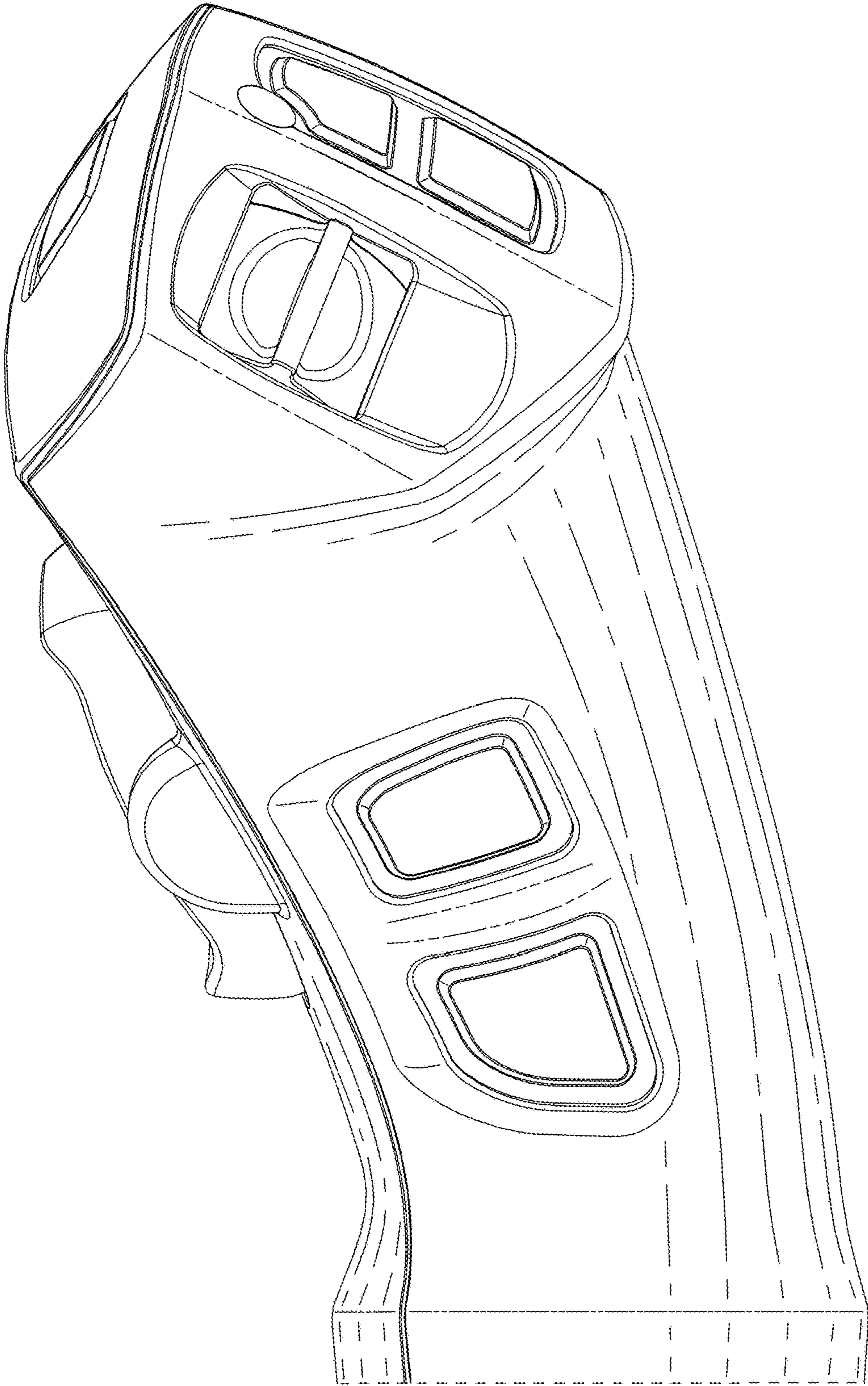

FIG. 2

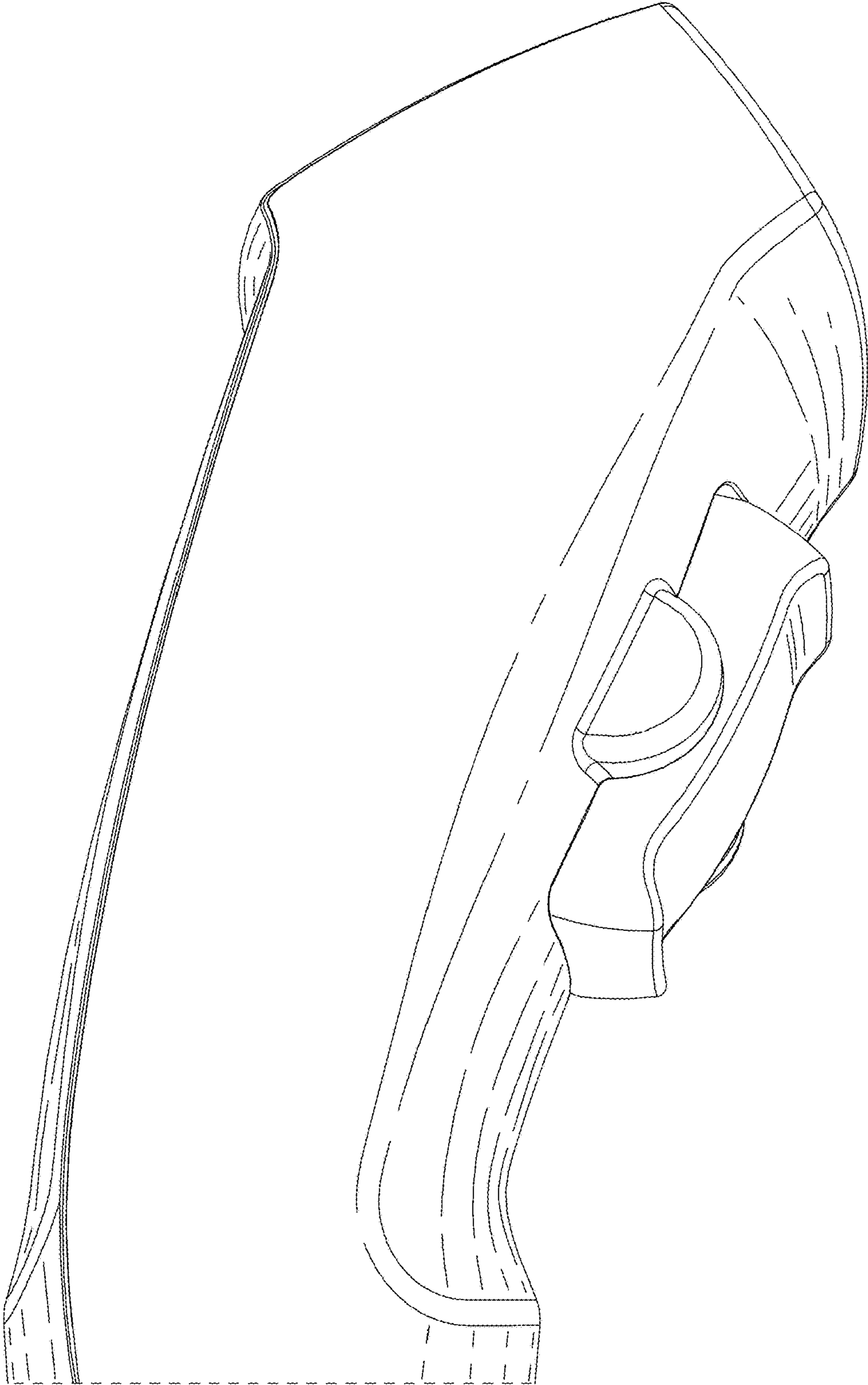

FIG. 3

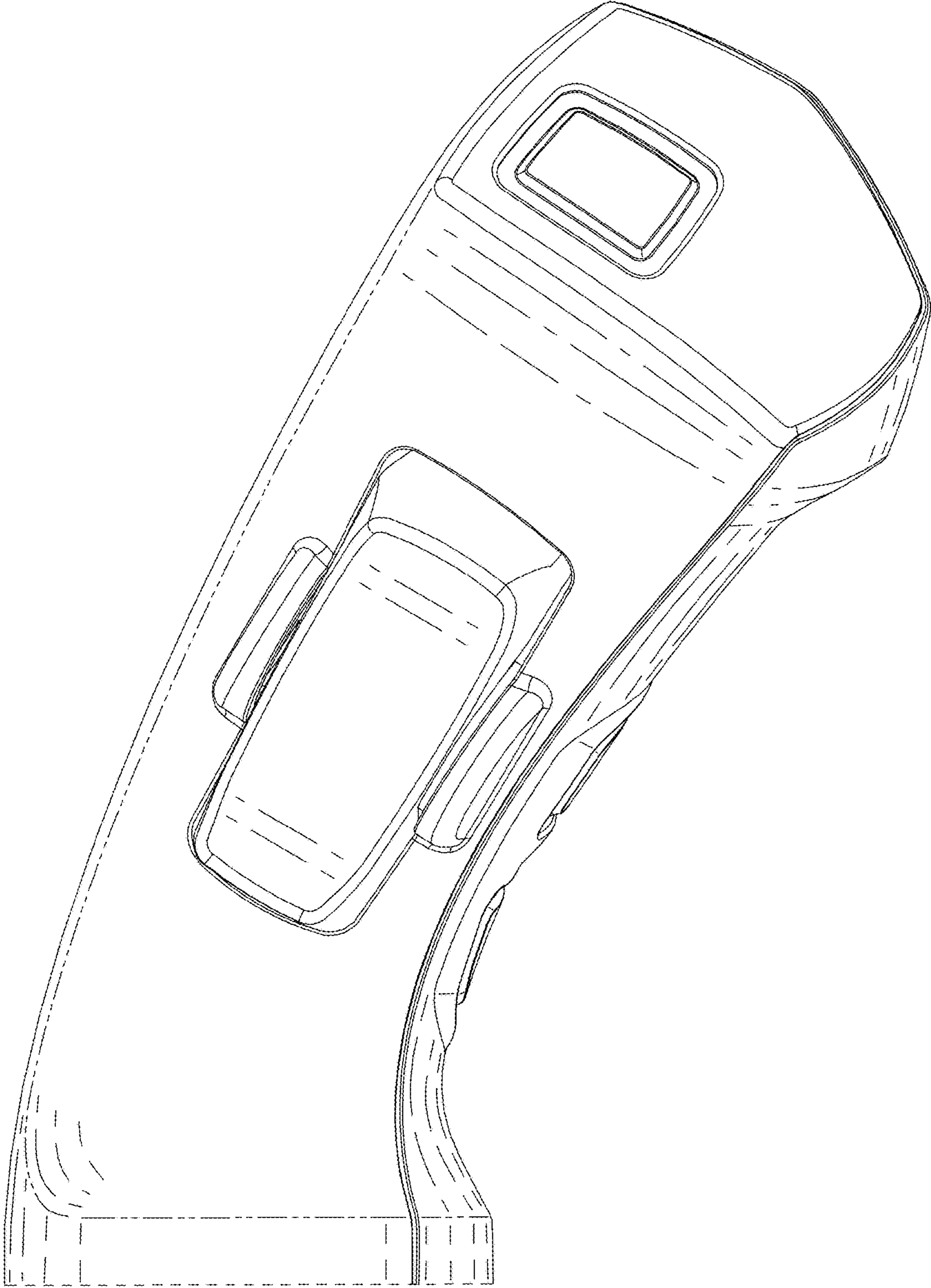

FIG. 4

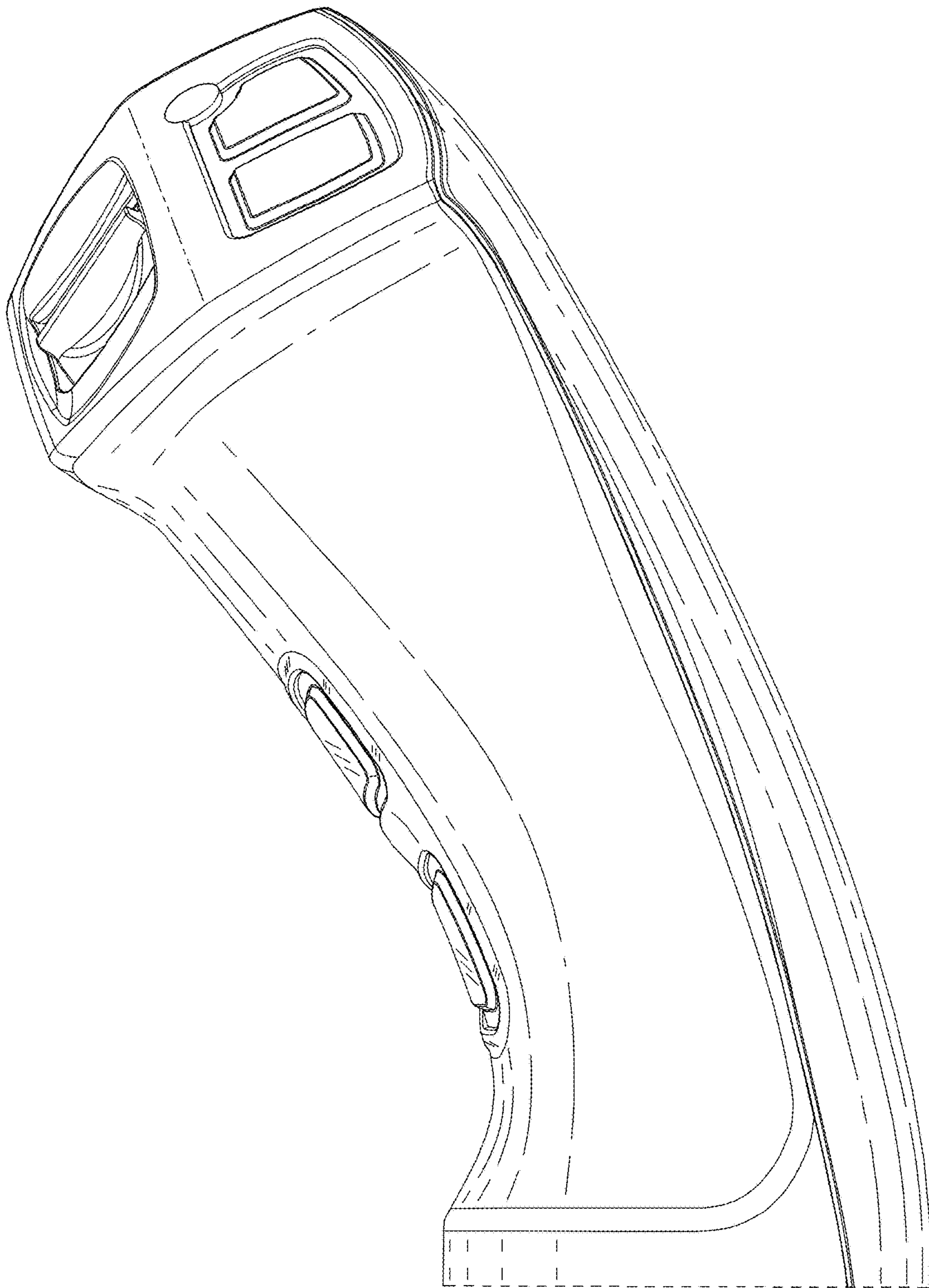

FIG. 5

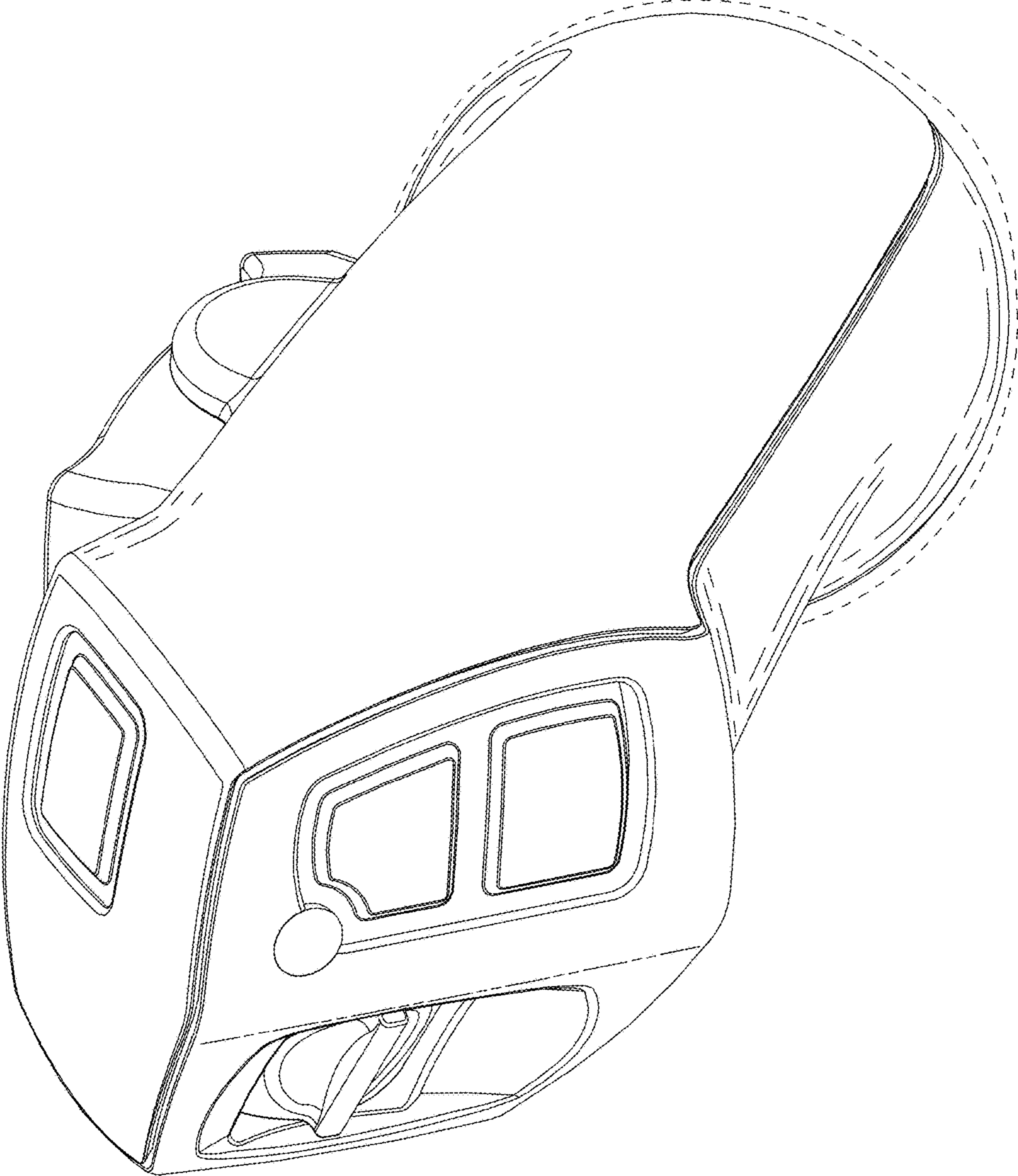

FIG. 6

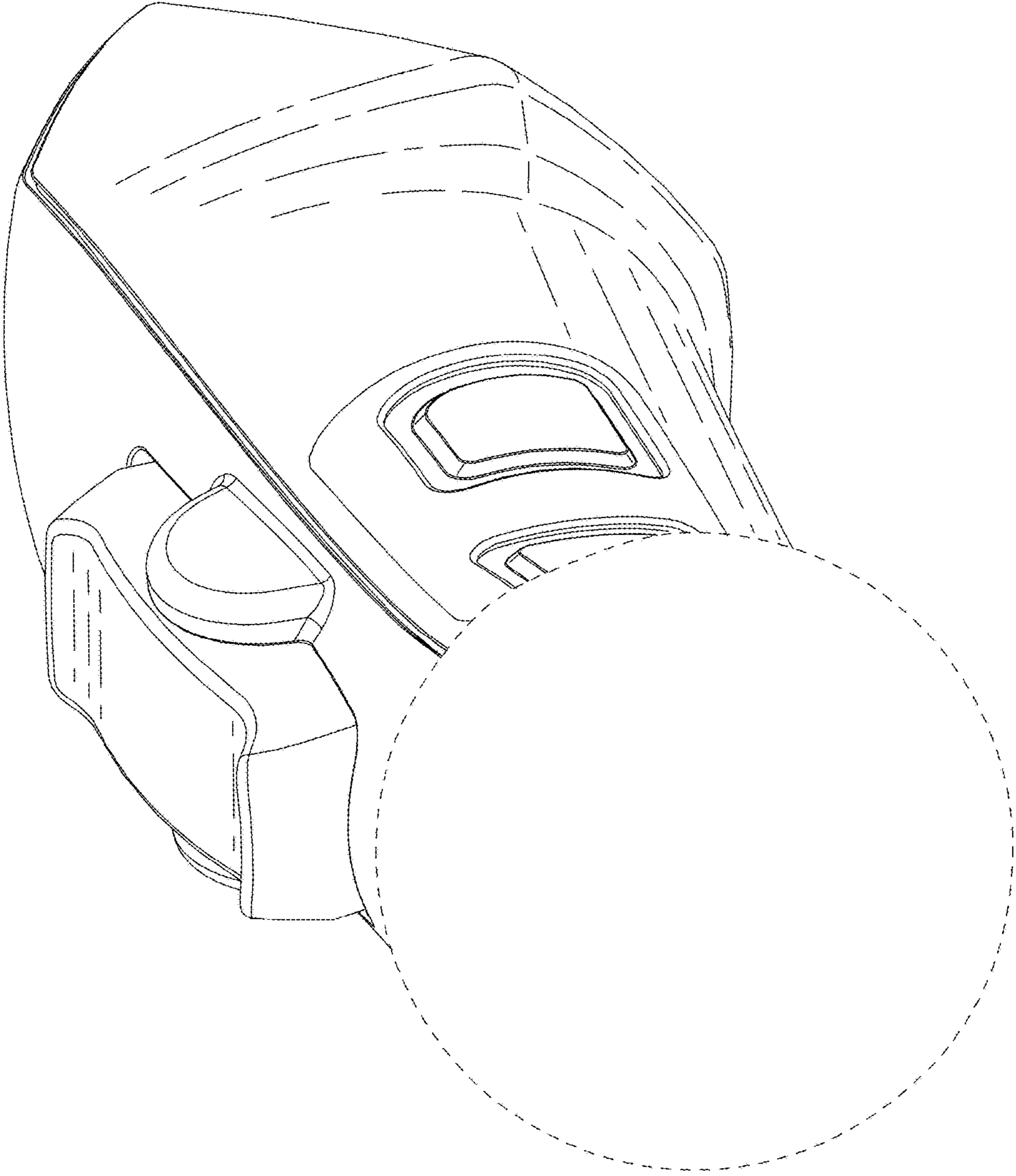

FIG. 7