



US00D844456S

(12) **United States Design Patent**  
**O'Neill**

(10) **Patent No.:** **US D844,456 S**

(45) **Date of Patent:** **\*\* Apr. 2, 2019**

(54) **PACKAGING**

(71) Applicant: **SUGARFINA, INC.**, El Segundo, CA (US)

(72) Inventor: **Rosie Colleen O'Neill**, El Segundo, CA (US)

(73) Assignee: **Sugarfina Inc.**, El Segundo, CA (US)

(\*\*) Term: **15 Years**

(21) Appl. No.: **29/663,542**

(22) Filed: **Sep. 17, 2018**

**Related U.S. Application Data**

(63) Continuation of application No. 29/609,563, filed on Jun. 30, 2017.

(51) **LOC (11) Cl.** ..... **09-03**

(52) **U.S. Cl.**  
USPC ..... **D9/737; D9/432**

(58) **Field of Classification Search**

USPC ..... D9/414, 418, 715, 721, 737, 756, 759;  
D3/201, 273, 274, 302; D7/629

CPC .. B65D 5/4204; B65D 5/5021; B65D 5/4208;  
B65D 85/1045; B65D 5/5035; B65D  
5/5213; B65D 5/22; B65D 5/38; B65D  
2519/00273; B65D 5/42; B65D 5/5038;  
B65D 2519/00323; B65D 5/5028; B65D  
5/5253; B65D 25/04; B65D 5/5016;  
B65D 5/68; B65D 85/00; B65D  
2543/00194; B65D 2543/00296; B65D  
2519/00711; B65D 2519/00034; B65D  
2519/00069; B65D 81/368; B65D  
21/0233; Y10S 206/804; Y10S 206/82

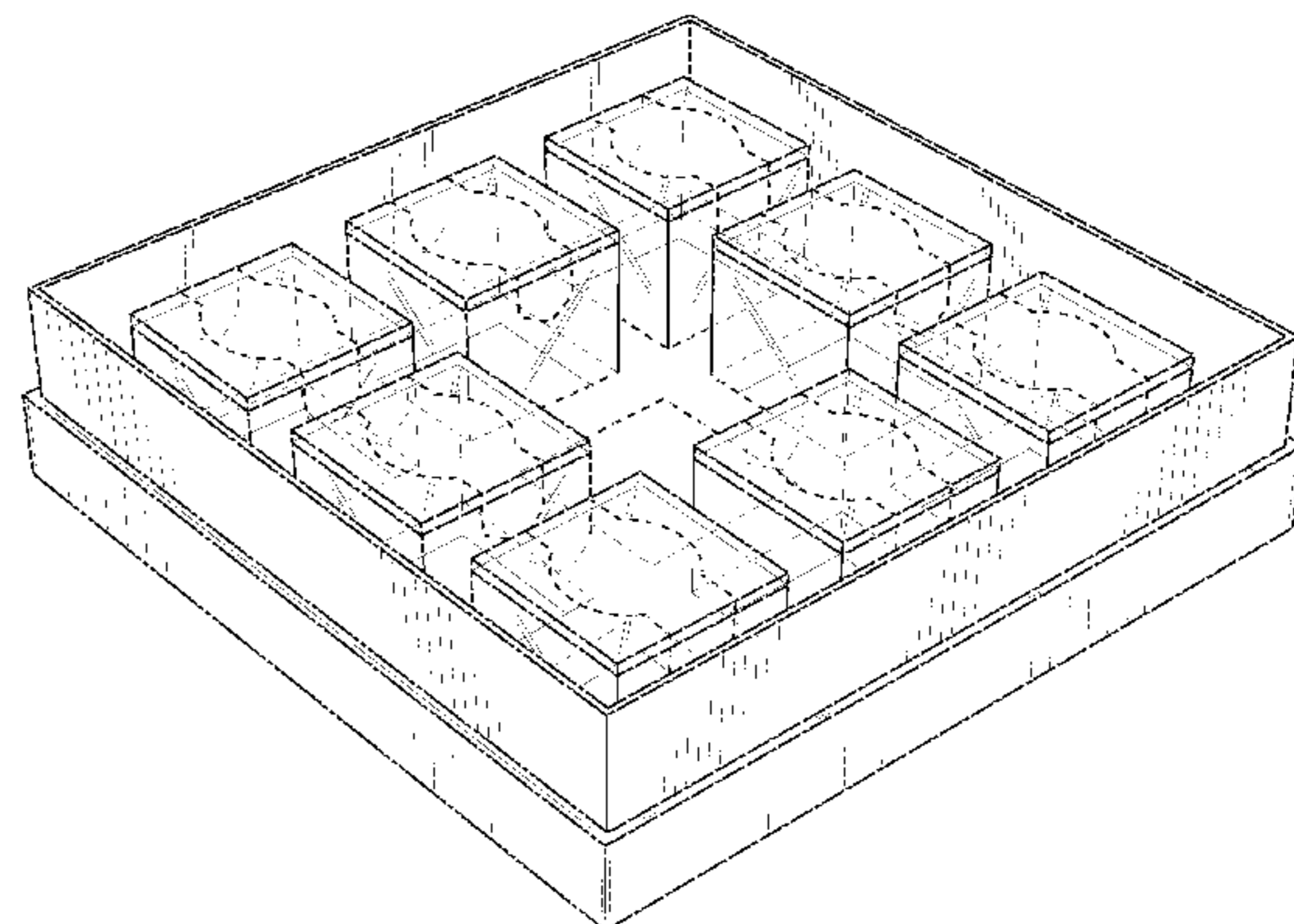
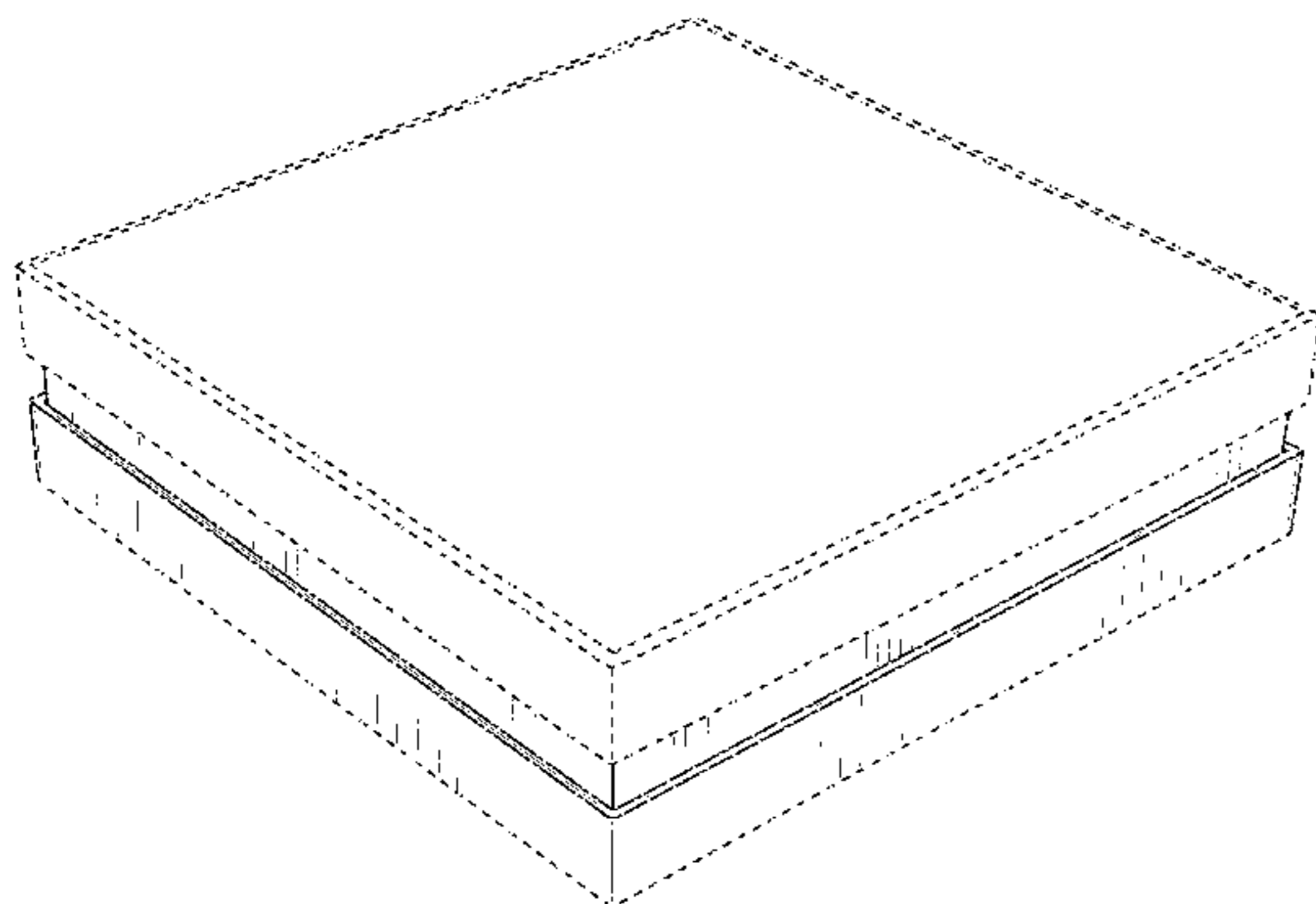
See application file for complete search history.

(56) **References Cited**

**U.S. PATENT DOCUMENTS**

228,158 A 5/1880 Woods  
D36,435 S 7/1903 Daggett  
D42,846 S 8/1912 Farrell

1,162,840 A	12/1915	Wood
1,588,857 A	6/1926	Sherman
D71,513 S	11/1926	Austin
1,620,789 A	3/1927	Urban, Jr.
1,697,880 A	1/1929	Peter
1,762,923 A	6/1930	Fegely
D86,128 S	2/1932	Levkoff
1,871,617 A	8/1932	King
1,892,092 A	12/1932	Barad
1,899,547 A	2/1933	Addis et al.
1,994,159 A	3/1935	Wurzburg
D95,429 S	4/1935	James et al.
2,522,049 A	9/1950	Lang
2,541,173 A	2/1951	Moore
2,597,377 A	5/1952	Robinson
2,604,980 A	7/1952	Reid
2,751,135 A	6/1956	Kessler
2,782,951 A	2/1957	Inman
2,790,589 A	4/1957	Moore
3,004,661 A	10/1961	Schumann
3,126,093 A	3/1964	Bradley et al.
3,357,543 A	12/1967	Taggart
3,423,006 A	1/1969	Stedman
3,494,534 A	2/1970	McFarland et al.
3,600,871 A	8/1971	Farquhar
3,660,934 A	5/1972	Pollack et al.
D242,771 S	12/1976	Papillon
D244,085 S	4/1977	Giddings et al.
4,139,096 A	2/1979	Sieger
D258,938 S	4/1981	Spitzer
D260,077 S	8/1981	Burns et al.
4,293,079 A	10/1981	Lytle
D292,876 S	11/1987	Grunhut
D292,877 S	11/1987	Grunhut
4,713,928 A	12/1987	Tisma
4,757,898 A	7/1988	Klein
D307,504 S	4/1990	Silcox
D315,297 S	3/1991	Campbell
D317,717 S	6/1991	Carol
D317,718 S	6/1991	Carol
5,038,940 A	8/1991	Okabe
5,096,056 A	3/1992	Garcia
D327,004 S	6/1992	Nadel
D329,601 S	9/1992	Samelson
D333,615 S	3/1993	Zutler
D335,819 S	5/1993	Campbell
D344,020 S	2/1994	Pavely
5,375,706 A	12/1994	Perez
D361,508 S	8/1995	Schnack
D361,661 S	8/1995	Masuda
D373,723 S	9/1996	Healey
5,555,982 A	9/1996	Kuhn et al.
5,590,786 A	1/1997	Jaycox



# US D844,456 S

Page 2

5,603,558 A	2/1997	Zimmer	D733,317 S	6/2015	Lui	
D380,417 S	7/1997	Hardy	D733,318 S	6/2015	Lui	
D380,926 S	7/1997	Goodburn et al.	9,061,790 B2	6/2015	Yagishita	
5,682,999 A	11/1997	Larson	D734,075 S	7/2015	Tapper	
5,791,468 A	8/1998	House	D738,721 S	9/2015	Song et al.	
5,817,510 A	10/1998	Pandey et al.	D741,193 S	10/2015	Lohuis et al.	
D411,308 S	6/1999	Pandey et al.	D748,280 S	1/2016	Lui	
D424,296 S	5/2000	David	D754,408 S	4/2016	Garrett et al.	
D424,425 S	5/2000	Ngai	D755,641 S	5/2016	O'Neill	
D426,902 S	6/2000	Hardy et al.	D756,560 S	5/2016	Ghiotti et al.	
D433,630 S	11/2000	Lubineau-Bigot et al.	D756,804 S	5/2016	Gross	
6,349,820 B1	2/2002	Kelley et al.	D758,191 S	6/2016	Tu et al.	
D455,073 S	4/2002	Mizrahi	D763,104 S	8/2016	Akana et al.	
D464,568 S	10/2002	Sisinni	D763,683 S	8/2016	O'Neill	
D464,885 S	10/2002	Weinstein et al.	D763,684 S	8/2016	O'Neill	
D468,100 S	1/2003	Bowling	D764,911 S	8/2016	Glass et al.	
6,533,166 B1	3/2003	Kaiss	D768,008 S	10/2016	Akana et al.	
D477,911 S	8/2003	Stuart	D769,727 S	10/2016	Lohuis et al.	
D492,194 S	6/2004	Kim	D769,986 S	10/2016	Timg	
D494,862 S	8/2004	Sisinni	D772,057 S	11/2016	Adams et al.	
6,923,556 B1	8/2005	Baker, III	D774,388 S	12/2016	Xia	
D510,528 S	10/2005	Funk	9,533,791 B2	1/2017	Fath	
D511,681 S	11/2005	Cogley et al.	D779,879 S	2/2017	Waler	
D521,733 S	5/2006	Kim	D780,569 S	3/2017	Bard et al.	
D522,376 S	6/2006	Hales	D780,570 S	3/2017	Bard et al.	
D528,794 S	9/2006	Lanham et al.	D787,186 S	5/2017	Thurbin	
D529,378 S	10/2006	Spencer et al.	D787,320 S	5/2017	Gill et al.	
D536,246 S	2/2007	Schneider	D789,752 S	6/2017	Zmrhal et al.	
7,264,123 B2	9/2007	Reed	D798,737 S	10/2017	Miller et al.	
D553,495 S	10/2007	Vandecasteele et al.	D821,087 S *	6/2018	Lihotzky .....	D3/203.1
D568,765 S	5/2008	Miles	D824,777 S *	8/2018	Arnett, Jr. ....	B65D 85/34
D580,263 S	11/2008	Yi Man				D9/600
D584,053 S	1/2009	Abdo et al.	D826,069 S *	8/2018	O'Neill .....	B65D 77/0413
D596,485 S	7/2009	Andre et al.				D9/737
D603,720 S	11/2009	Cesare et al.	10,053,274 B1 *	8/2018	O'Neill .....	B65D 79/00
D609,116 S	2/2010	Kim	D829,569 S *	10/2018	O'Neill .....	D9/759
7,757,843 B2	7/2010	Katsis	D831,479 S	10/2018	Lylyk	
D621,548 S	8/2010	Chen	2002/0108880 A1	8/2002	Krupa et al.	
D643,306 S	8/2011	Martinez et al.	2006/0266672 A1	11/2006	Young	
8,006,842 B1	8/2011	Loughlin, Jr. et al.	2006/0283733 A1	12/2006	Masa	
D646,984 S	10/2011	Moore et al.	2007/0095693 A1	5/2007	DeLuca	
8,109,389 B1	2/2012	Amer	2008/0190788 A1	8/2008	Cziraky	
D657,284 S	4/2012	Young	2009/0242455 A1	10/2009	Adams et al.	
D663,520 S	7/2012	Antler	2010/0012672 A1	1/2010	Piron	
D664,312 S	7/2012	Bizzle	2010/0187227 A1	7/2010	Wang	
8,272,509 B1	9/2012	McCutchen	2011/0174166 A1	7/2011	Sparacio et al.	
D669,352 S	10/2012	Paslowski	2012/0168434 A1	7/2012	Algarda Cervera et al.	
D670,931 S	11/2012	Tapper	2012/0168443 A1	7/2012	Maness	
D670,932 S	11/2012	Tapper	2013/0161378 A1	6/2013	Nebeker et al.	
D673,864 S	1/2013	Read et al.	2013/0240387 A1	9/2013	Pugh	
D675,539 S	2/2013	Bilgarians	2013/0248531 A1	9/2013	Lane	
D682,119 S	5/2013	Buford	2014/0021086 A1	1/2014	Roesler	
D685,578 S	7/2013	Pestell	2014/0166736 A1	6/2014	Kato	
D686,065 S	7/2013	Kuo et al.	2014/0312107 A1	10/2014	Nash	
D686,491 S	7/2013	Kuo et al.	2015/0093509 A1	4/2015	Kennedy et al.	
D687,321 S	8/2013	Pralus	2015/0232245 A1	8/2015	Fullan	
D690,554 S	10/2013	Presley	2015/0321811 A1	11/2015	Yeung	
D691,465 S	10/2013	O'Brien et al.	2016/0009473 A1	1/2016	Korinek et al.	
D691,900 S	10/2013	Kraus	2016/0046404 A1	2/2016	Cheeser et al.	
D698,639 S	2/2014	Fletcher et al.	2016/0185511 A1	6/2016	O'Neill	
D698,664 S	2/2014	Abbott	2016/0264285 A1 *	9/2016	Madwar .....	B65D 5/445
D700,462 S	3/2014	Boos	2017/0050797 A1	2/2017	Farid et al.	
D704,550 S	5/2014	Mattila et al.	2017/0076343 A1	3/2017	Bernstein et al.	
D706,627 S	6/2014	Olsson et al.	2017/0138660 A1	5/2017	Huckaby et al.	
D709,305 S	7/2014	Tapper	2017/0152092 A1	6/2017	Glass et al.	
D709,306 S	7/2014	Tapper				
D709,364 S	7/2014	Olsson et al.				
D712,176 S	9/2014	Tamilarasan				
D712,748 S	9/2014	Akana et al.				
D713,739 S	9/2014	Akana et al.				
D717,165 S	11/2014	Kwak et al.				
D722,870 S	2/2015	Fohner et al.				
D728,358 S	5/2015	Belamich				
D729,636 S	5/2015	Steinberger				
D730,749 S	6/2015	Young et al.				
D731,323 S	6/2015	O'Neill				
D731,325 S	6/2015	Loessin				
D733,314 S	6/2015	Lui				
D733,315 S	6/2015	Lui				

## FOREIGN PATENT DOCUMENTS

DE	M9202895-0002	9/1992
DE	G1997182206	3/1993
IL	51964	10/2013
JP	1503649 S	7/2014
JP	1530877 S	8/2015
JP	1537477 S	11/2015
JP	1541182 S	1/2016
JP	1562136 S	1/2017
JP	D1600162	3/2017
KR	30-0377284-0000	3/2005
KR	30-04151920-0000	6/2007

TW	099232	5/1988
TW	D119491	10/2007
TW	D186765 S	11/2017

## OTHER PUBLICATIONS

Sugarfina Partners With Sanrio to Create the Cutest Hello Kitty Candy on the Planet. [online] Published Sep. 17, 2017. Retrieved Nov. 20, 2017 from URL: <https://www.popsugar.com/food/photo-gallery/44018877/image/44018885/Sugarfinas-Pop-Up-Candy-Bento-Box-30>.

Rigid Set-up Box, Wine and Champagne Chocolate Leather Gift Box, Faux Leather, Dark Brown, Qty/Case-6. [online] Retrieved Nov. 22, 2017 from URL: <https://www.aspecialtybox.com/RG00F-00493-C>.

House Drawer Gift Box/CMXSSGB-10. [online] Retrieved Nov. 22, 2017 from URL: <http://www.charmpackaging.com/special-shape-gift-box/house-drawer-gift-box-cmxssgb-010.html>.

10 fanciest candies from Sugarfina's New York shop—NY; <http://www.nydailynews.com/life-style/eats/10-fanciest-candies-sugarfina-new-york-shop-article-1.2407237>; Oct. 22, 2015; 9 pages.

A Candy Emporium for Adults; <https://www.entrepreneur.com/article/236286>; Aug. 25, 2014; 10 pages.

A Sweet Evening at Sugarfina—SavvySleepers; <https://www.savvysleepers.com/blogs/the-benefits-of-satin/44181636-a-sweet-evening-at-sugarfina>; Aug. 31, 2015; 7 pages.

Candy Critic: Boxes and Boxes of Gummies From Sugarfina; <http://candy-critic.blogspot.com/2013/05/boxes-and-boxes-of-gummies-from.html>; May 2, 2013; 2 pages.

Luxurious One-of-a-Kind Candy Shop Tour With Sugarfina—Best Friends for Frosting; <https://bestfriendsforfrosting.com/2015/11/luxurious-one-kind-candy-sugarfina/>; Nov. 17, 2015; 16 pages.

Drool Worthy Sweets in Cute Packaging Beckon at Sugarfina Candy Shop; <http://www.7x7.com/drool-worthy-sweets-in-cute-packaging-beckon-at-sugarfina-candy-shop-1787196138.html>; Jul. 15, 2015; 4 pages.

Emiiiichan Blog\_Sugarfina candy order; <https://emiiiichan.blogspot.com/2014/11/sugarfina-candy-order.html>; Nov. 21, 2014, 18 pages.

Fancy candy brand selects fancier Dallas destination for Texas debut; <http://dallas.culturemap.com/news/restaurants-bars/10-29-15-sugarfina-highland-park-village-market-candy/>; Oct. 29, 2015; 4 pages.

Jonathan Adler Sugarfina Bento Boxes\_InStyle.com; <http://www.instyle.com/lifestyle/news/sugarfina-loves-jonathan-adler-collection>; Apr. 11, 2016; 2 pages.

Kasey's Kitchen: Kasey's Favorite Thing #20: Sugarfina; <http://kaseyskitchentv.blogspot.com/2013/12/kaseys-favorite-thing-20-sugarfina.html>; Dec. 17, 2013; 3 pages.

NYC Guide: Sugarfina—York Avenue; <https://yorkavenueblog.com/nyc-guide-sugarfina/>; Oct. 26, 2015; 74 pages.

Rebecca's Delights: Sugarfina Gourmet Candy—Author Rebecca Kelsey Sampson; <http://rebeccakelsey.com/2012/11/rebeccas-delights-sugarfina-gourmet-candy>; Nov. 12, 2012; 6 pages.

People Freaked Out So Hard Trying to Get Rosé Gummy Bears that They Crashed the Website; <https://www.forbes.com/sites/meghancasserly/2013/04/09/sugarfina-facebook-candy-shop-outerspace/#78cb39dd6e74>; Jun. 29, 2016; 14 pages.

Rosie O'Neill of Sugarfina—The Everygirl; <http://theeverygirl.com/rosie-oneill-of-sugarfina>; May 18, 2014; 27 pages.

Sugar & Charm // Sugarfina—Mary Costa Photography; <http://marycostaphotography.com/sugar-charm-sugarfina/>; Apr. 22, 2014; 24 pages.

Sugar Fix: Sugarfina Pasadena; <https://studiodiy.com/2015/07/21/sugar-fix-sugarfina-pasadena/>; Jul. 21, 2015; 15 pages.

Sugarfina—A Unique Candy Boutique at The Americana; <http://www.realmomofsfv.com/2014/06/18/sugarfina-a-unique-candy-boutique-at-the-americana/>; Jun. 18, 2014; 28 pages.

Sugarfina (Beverly Hills, CA) • The Episodic Eater; <https://www.theepisodiceater.com/sugarfina-beverly-hills-ca/>; unknown date; 29 pages.

Sugarfina Beverly Hills & Trio of Goodies—Candy Blog; [http://www.candyblog.net/blog/item/sugarfina\\_trio\\_of\\_goodies](http://www.candyblog.net/blog/item/sugarfina_trio_of_goodies); Dec. 16, 2013; 11 pages.

Sugarfina—Candy Happiness!; <http://luluandlattes.com/2013/06/27/sugarfina-candy-happiness/>; Jun. 27, 2013; 11 pages.

Sugarfina Launches—Atlanta's Lenox Square Just Got Sweeter!; <http://www.momsmagicalmiles.com/sugarfina-launches-atlantas-lenox/>; Nov. 6, 2015; 15 pages.

Sugarfina << MDH Mark D Hogan; <https://markdhogan.wordpress.com/tag/sugarfina/>; Aug. 29, 2013; 7 pages.

Sugarfina Part I—Foodette Reviews; <http://foodettereviews.com/?p=24>; Sep. 10, 2013; 7 pages.

Sugarfina: One Candy-Coated Startup's Plans for a Lucrative Exit—But First a Trip to Space; <https://www.forbes.com/sites/meghancasserly/2013/04/09/sugarfina-facebook-candy-shop-outerspace/#78cb39dd6e74>; Apr. 9, 2013; 6 pages.

Sugarfina Representative Facebook posts; <https://www.facebook.com/Sugarfina>; 25 pages.

Sugarfina Representative Instagram posts; <https://www.instagram.com/sugarfina/?hl=en>; 40 pages.

Sugarfina Representative Twitter posts; <https://twitter.com/sugarfina>; 91 pages.

Sugarfina: Sampling the Sweets—York Avenue; <https://yorkavenueblog.com/sugarfina-sampling-sweets/>; Sep. 8, 2014; 7 pages.

Sugarfina: The Chocolates—Candy Blog; [http://www.candyblog.net/blog/item/sugarfina\\_the\\_chocolates](http://www.candyblog.net/blog/item/sugarfina_the_chocolates); Jul. 16, 2013; 11 pages.

Sugarfina: The Gummies—Candy Blog; [http://www.candyblog.net/blog/item/sugarfina\\_the\\_gummies](http://www.candyblog.net/blog/item/sugarfina_the_gummies); Jul. 10, 2013; 11 pages.

Sugarfina—Thrillist LA; <https://www.thrillist.com/eat/los-angeles/we-fed-a-kid-absinthe-candy-here-s-what-happened-thrillist-la>; Dec. 16, 2013; 35 pages.

Talking Shop: Sugarfina—Sugar Paper; <https://sugarpaper.com/blogs/news/87503553-talking-shop-sugarfina>; Feb. 11, 2016; 13 pages.

Treat yourself: Sugarfina!\_Twinkie Chan Blog; <http://blog.twinkiechan.com/2012/09/20/treat-yourself-sugarfina/>; Sep. 20, 2012; 13 pages.

Whispering Angel Rosé-Infused Gummy Bears are Summer's Hottest Sweet—The Glamorous Gourmet; <https://theglamorousgourmet.com/whispering-angel-rose-gummy-bears-summers-hottest-sweet/>; Jul. 31, 2016; 13 pages.

International Search Report and Written Opinion for International Application No. PCT/US2017/057660 dated Jan. 25, 2018, 9 pages. Translation of Office Action and Search Report for Taiwan Design Patent Application No. 106306912 dated Jun. 12, 2018; 3 pages.

Chocomize, Candy Cube Boxes, [www.chocomize.com/candy-cube-box-9pc.html](http://www.chocomize.com/candy-cube-box-9pc.html) (Jun. 29, 2017).

MidNite Snax, Signature Sets, [http://midnitesnax.com/home\\_page\\_files/view/1265/file.pdf](http://midnitesnax.com/home_page_files/view/1265/file.pdf) (Jun. 29, 2017).

Sweet Pete's, Build-a-Candy-Cube-Box, <https://www.sweetpetescandy.com/collections/build-a-candy-cube-box> (Jun. 29, 2017).

Sweet Pete's, Pete's Picks Collection, [www.sweetpetescandy.com/collections/boxes](http://www.sweetpetescandy.com/collections/boxes) (Mar. 23, 2016).

Sweitzer Candy Shop, Gifts, <https://sweitzercandy.com/index.php/gift-boxes.html> (Jun. 29, 2017).

Sugarfina, Design Your Own Bento, [www.sugarfina.com/shop/gift-shop/gift-type/design-your-own-bento](http://www.sugarfina.com/shop/gift-shop/gift-type/design-your-own-bento) (Jun. 29, 2017).

Sugarfina, Custom Catalogue, <https://issuu.com/sugarfina/docs/2017-corporatecatalog-ppai-webversi> (Jun. 29, 2017).

Teapressa, Tea + Cube, available at <https://teapressa.com/collections/gifts/products/tea-cube> (Jun. 29, 2017).

Sweitzer Candy Gift Box 8, available Feb. 21, 2015, [online], [site visited Aug. 2, 2017]. Available from internet, <URL: <https://web.archive.org/web/20150221225755/https://sweitzercandy.com/index.php/gift-boxes.html>, 2 pages.

Sweitzer Candy Gift Box 4, available Feb. 21, 2015, [online], [site visited Aug. 2, 2017]. Available from internet, <URL: <https://web.archive.org/web/20150221225755/https://sweitzercandy.com/index.php/gift-boxes.html>, 2 pages.

"A Taste of Paradise," Collection by Sugarfina, available Aug. 2, 2017, [online], [site visited Aug. 2, 2017]. Available from internet, <URL: <https://www.sugarfina.com>, 1 page.

Cubetas, [online], [site visited Aug. 16, 2017]. Available from internet, <URL: <http://cubetas.jp/>>, 19 pages.

Bonbonist—<https://thebonbonist.com/>; Oct. 18, 2017, 4 pages.

Bonbonist Box Photo—Facebook—<https://www.facebook.com/thebonbonist/photos/a.1493876617357861.1073741829.1290401221038736/1493876580691198/?type=3&theater>; Oct. 1, 2017, 1 page.

Bouquet Bar 3 Piece Box Photo—Instagram—<https://www.instagram.com/p/BPs-h6rBWic/?taken-by=thebouquetbar>; Jan. 25, 2017, 1 page.

Bouquet Bar 6 Piece Box Photo—“It’s Time to Ditch the Red Roses: Six Better Ways to Give Your Valentine Flowers,” People Home & Travel; Jan. 31, 2017, 10 pages.

Bouquet Bar 6 Piece Photo—Instagram—<https://www.instagram.com/p/BP-9I12hV9Q/?taken-by=thebouquetbar>; Feb. 1, 2017, 1 page.

Chocomize 2 Piece Box—<https://www.chocomize.com/candy-cubes-2pack.html>; Oct. 16, 2017, 4 pages.

Chocomize 3 Piece Box Photo—Facebook—<https://www.facebook.com/Chocomize/photos/a.423529781180.220124.176532311180/10154561729211181/?type=3&theater>; Nov. 11, 2016, 1 page.

Chocomize 6 Piece Box—<https://www.chocomize.com/candy-cube-6pcs-box.html>; Oct. 16, 2017, 3 pages.

Chocomize 9 Piece Box Photo—Instagram—<https://www.instagram.com/p/BI5r4s6BLH7/?taken-by=chocomize>; Aug. 9, 2016, 1 page.

Chocomize 9 Piece Box Photo—Instagram—<https://www.instagram.com/p/BMpjEEUhpqV/?taken-by=chocomize>; Nov. 10, 2016, 1 page.

Chocomize 9 Piece Box Photo—Instagram—<https://www.instagram.com/p/BMrp0YdhQeU/?taken-by=chocomize>; Nov. 11, 2016, 1 page.

Cubetas 2 Piece and 3 Piece Box Photo—Instagram—<https://www.instagram.com/p/BMyWwq0BQoH/?taken-by=cubetas.2016>; Nov. 14, 2016, 1 page.

Cubetas 2 Piece and 3 Piece Box Photo—Instagram—<https://www.instagram.com/p/BNtkhJpBzYm/?taken-by=cubetas.2016>; Dec. 7, 2016, 1 page.

Cubetas 2 Piece Box Photo—Instagram—<https://www.instagram.com/p/BMQ9Bjihqyz/?taken-by=cubetas.2016>; Nov. 1, 2016, 1 page.

Cubetas 3 Piece Box Photo—Instagram—<https://www.instagram.com/p/BPrxqTThloh/?taken-by=cubetas.2016>; Jan. 25, 2017, 1 page.

Foxes Events 6 Piece Box Photo—Instagram—<https://www.instagram.com/p/BQVMWj7jZke/?taken-by=foxesevents&hl=en>; Feb. 10, 2017, 1 page.

Idea Stage 2 Piece Box—<https://www.ideastage.com/Cube-Shaped-Candy-Set-965458328>; Oct. 13, 2017, 2 pages.

Sugarwish 2 Piece and 4 Piece Boxes—<https://web.archive.org/web/20151201071311/https://sugarwish.com/choose-a-sugarwish>; Dec. 1, 2015, 1 page.

Sweet Lounge 2 Piece Box—<https://www.sweetlounge.co.uk/lounge-box-hello-spring-collection-for-vegans/>; Oct. 16, 2017, 6 pages.

Sweet Lounge 3 Piece and 4 Piece Box Photo—Instagram—[https://www.instagram.com/p/BM\\_eHn6g8ly/?taken-by=sweetloungeuk](https://www.instagram.com/p/BM_eHn6g8ly/?taken-by=sweetloungeuk); Nov. 19, 2016, 1 page.

Sweet Lounge 3 Piece and 4 Piece Box Photo—Instagram—[https://www.instagram.com/p/BMY\\_iidAMwX/?taken-by=sweetloungeuk](https://www.instagram.com/p/BMY_iidAMwX/?taken-by=sweetloungeuk); Nov. 4, 2016, 1 page.

Sweet Lounge 4 Piece Box—Instagram—<https://www.instagram.com/p/BNMnfaJgwOo/?taken-by=sweetloungeuk>; Nov. 24, 2016, 1 page.

Sweet Lounge 4 Piece Box—<https://www.sweetlounge.co.uk/lounge-box-hello-spring-collection/>; Oct. 16, 2017, 7 pages.

Sweet Lounge 4 Piece Box Video Snapshots—Facebook—<https://www.facebook.com/sweetloungeuk/videos/vb.670728213008752/1188285557919679/?type=2&theater>; Nov. 16, 2016, 6 pages.

Sweet Pete’s 8 Piece Box—[www.sweetpetescandy.com/collections/create-a-box](http://www.sweetpetescandy.com/collections/create-a-box); Nov. 18, 2016, 2 pages.

Sweitzer Candy 3 Piece Box Photo—Instagram—<https://www.instagram.com/p/440XveluqO/?taken-by=sweitzercandy>; Jul. 8, 2015, 1 page.

Sweitzer Candy 4 Piece Box Photo—Instagram—<https://www.instagram.com/p/440XveluqO/?taken-by=sweitzercandy>; Apr. 16, 2015, 1 page.

Sweitzer Candy 8 Piece Box Photo—Instagram—<https://www.instagram.com/p/wLDm8Olujs/?taken-by=sweitzercandy>; Dec. 4, 2014, 1 page.

Webb Company 2 Piece Box Photo—Facebook—<https://www.facebook.com/webbcollection/photos/a.376918812240.156708.376836382240/10154628557212241/?type=3&theater>; Oct. 18, 2016, 1 page.

Webb Company 4 Piece Box—<https://www.facebook.com/webbcollection/photos/a.376918812240.156708.376836382240/10154602255037241/?type=3&theater>; Oct. 11, 2016, 1 page.

Weeny Beeny 3 Piece Box Photo—Facebook—<https://www.facebook.com/weenybeenyl23/>; Jan. 31, 2017, 1 page.

Weeny Beeny 4 Piece Box Photo—Facebook—<https://www.facebook.com/weenybeenyl23/>; Jan. 31, 2017, 1 page.

Mariebelles.com archived webpage (available at <https://web.archive.org/web/20070624034428/http://www.mariebelle.com/category.cfm?showCategoryID=12>), purported by the Internet Archive WayBack Machine to have been publicly available Jun. 24, 2007, 1 page.

Alto Nivel, Top 10 de Chocolates Gourmet de Lujo (Jun. 26, 2011) (available at <https://www.altonivel.com.mx/estilo-de-vida/top-10-de-chocolates-gourmet-de-lujo/>), 13 pages.

Alto Nivel, Top 10 de Chocolates Gourmet de Lujo (Jun. 26, 2011) (available at <https://www.altonivel.com.mx/estilo-de-vida/top-10-de-chocolates-gourmet-de-lujo/>), machine translation, 12 pages.

MAGMA Google Group, “Sweet” (Mar. 11, 2011) (available at [https://groups.google.com/forum/print/msg/magma-massar/sUT3yoay0mE/5gOUk5AKMzQJ?ctz=4721738\\_76\\_76\\_104100\\_72\\_446760](https://groups.google.com/forum/print/msg/magma-massar/sUT3yoay0mE/5gOUk5AKMzQJ?ctz=4721738_76_76_104100_72_446760)), 11 pages.

Yelp photo uploaded by Adam D. on Mar. 8, 2014 (available at [https://www.yelp.com/biz\\_photos/mariebelles-new-york-3?select=ggKtO2Mx-jLH82WREkN7iA](https://www.yelp.com/biz_photos/mariebelles-new-york-3?select=ggKtO2Mx-jLH82WREkN7iA)), 1 page.

Yelp photo uploaded by Farhana S. on May 25, 2015 (available at [https://www.yelp.com/biz\\_photos/mariebelles-new-york-3?select=bewjLhJxzOfxHTN2m0-Ghg](https://www.yelp.com/biz_photos/mariebelles-new-york-3?select=bewjLhJxzOfxHTN2m0-Ghg)), 1 page.

Yelp photo uploaded by Amy K. on Feb. 20, 2016 (available at [https://www.yelp.com/biz\\_photos/mariebelles-new-york-3?select=aSrM2Gu\\_DuexeX67uD4p9Q](https://www.yelp.com/biz_photos/mariebelles-new-york-3?select=aSrM2Gu_DuexeX67uD4p9Q)), 1 page.

Yelp photo uploaded by Adrienne D. on Nov. 8, 2016 (available at [https://www.yelp.com/biz\\_photos/mariebelles-new-york-3?select=tEA9kZR4JsKfDBSu8uSIIQ](https://www.yelp.com/biz_photos/mariebelles-new-york-3?select=tEA9kZR4JsKfDBSu8uSIIQ)), 1 page.

Yelp photo uploaded by Dani V. on Jan. 4, 2007 (available at [https://www.yelp.com/biz\\_photos/mariebelles-new-york-3?select=5MkHMGtiRD-hWFLhdHivKg](https://www.yelp.com/biz_photos/mariebelles-new-york-3?select=5MkHMGtiRD-hWFLhdHivKg)), 1 page.

Banat-Style.com, Mar. 1, 2010 (available at <http://forums.banat-style.com/arabgirlsfashion143108/>), 46 pages.

\* cited by examiner

*Primary Examiner* — Lauren R Calve  
(74) *Attorney, Agent, or Firm* — Troutman Sanders LLP;  
Alexis Simpson; Chris Davis

(57) **CLAIM**

The ornamental design for a packaging, as shown and described.

#### DESCRIPTION

FIG. 1 is a perspective view of a packaging showing my new design.

FIG. 2 is a left view thereof.

FIG. 3 is a right view thereof.

FIG. 4 is a front view thereof.

FIG. 5 is a rear view thereof.

FIG. 6 is a top view thereof.

FIG. 7 is a bottom view thereof.

FIG. 8 is a perspective view thereof, shown without the top for clarity of illustration.

FIG. 9 is a left view thereof, shown without the top for clarity of illustration.

FIG. 10 is a right view thereof, shown without the top for clarity of illustration.

FIG. **11** is a front view thereof, shown without the top for clarity of illustration.

FIG. **12** is a rear view thereof, shown without the top for clarity of illustration.

FIG. **13** is a top view thereof, shown without the top for clarity of illustration.

FIG. **14** is a bottom view thereof, shown without the top for clarity of illustration; and,

FIG. **15** is an exploded perspective view of the packaging showing my new design.

The broken lines shown represent unclaimed subject matter and form no part of the claimed design. The shade lines shown represent surface shading and not surface ornamentation, color, or material type. The long-dash short-dash lines show an unclaimed boundary that forms no part of the claimed design. The space between the long-dash short-dash lines and broken lines also forms no part of the claimed design.

**1 Claim, 15 Drawing Sheets**

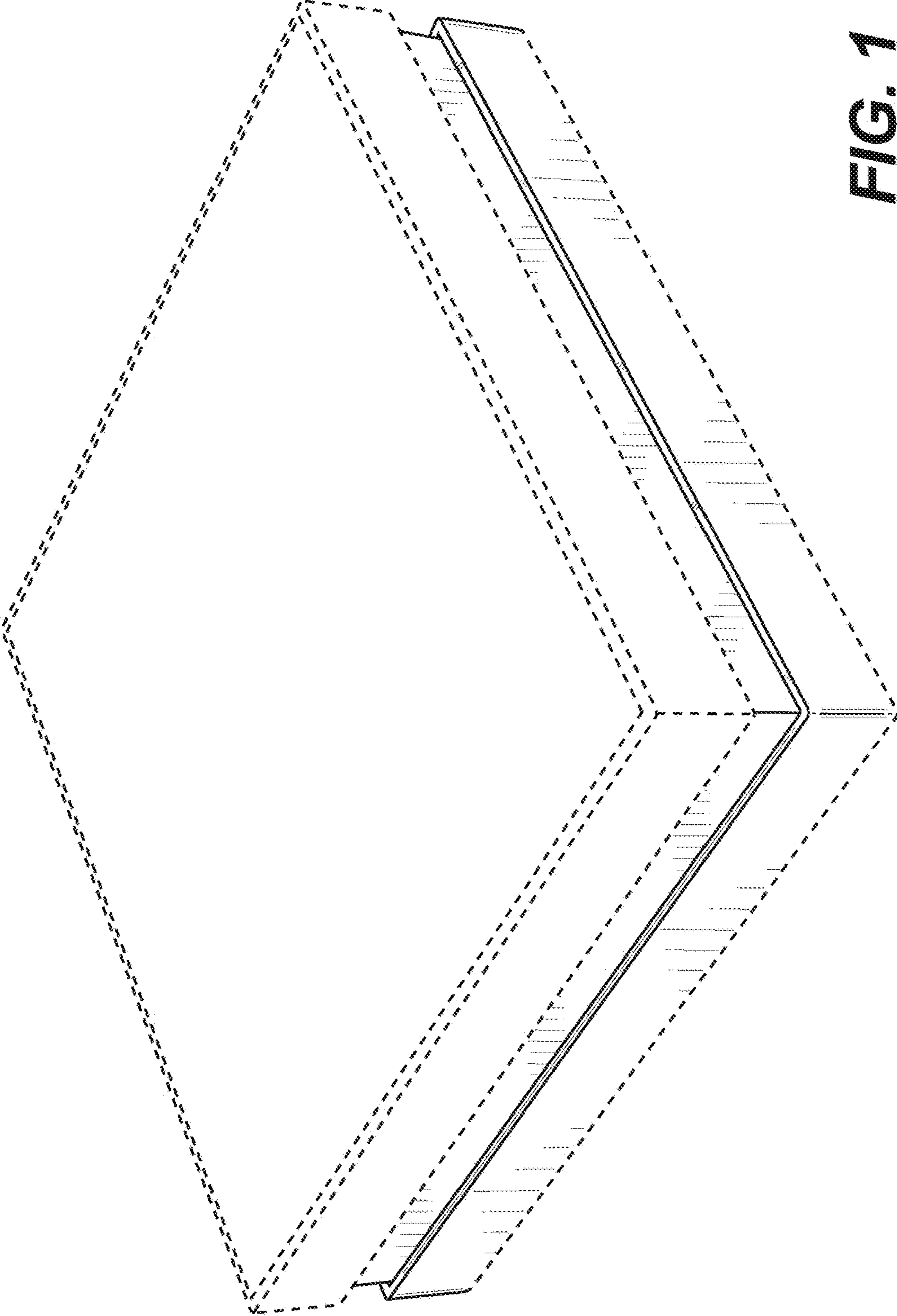
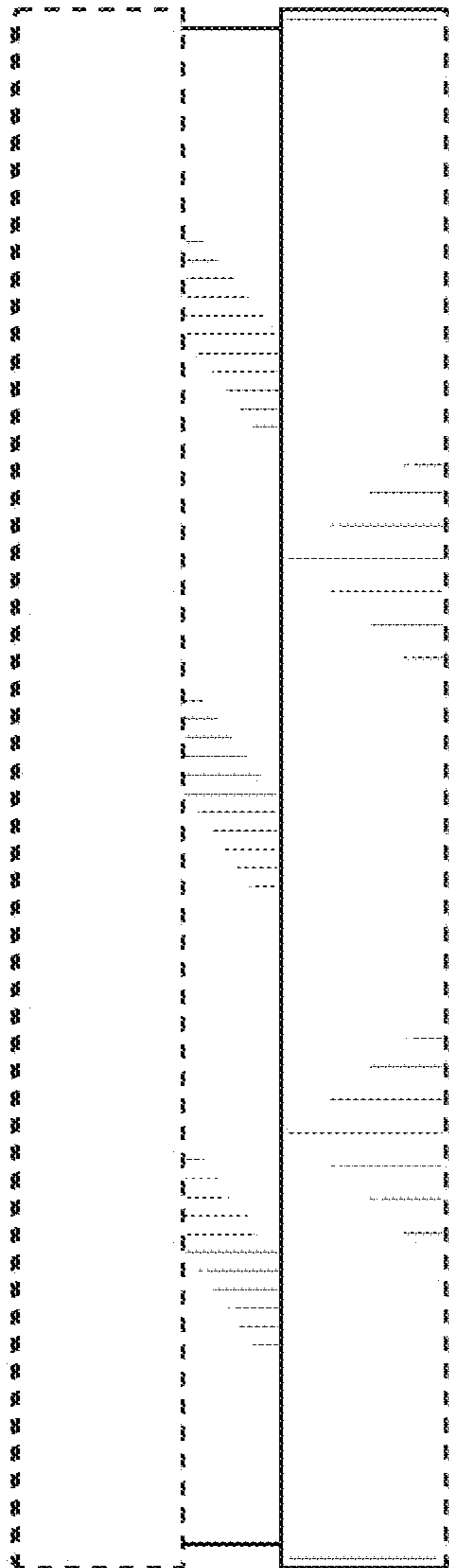
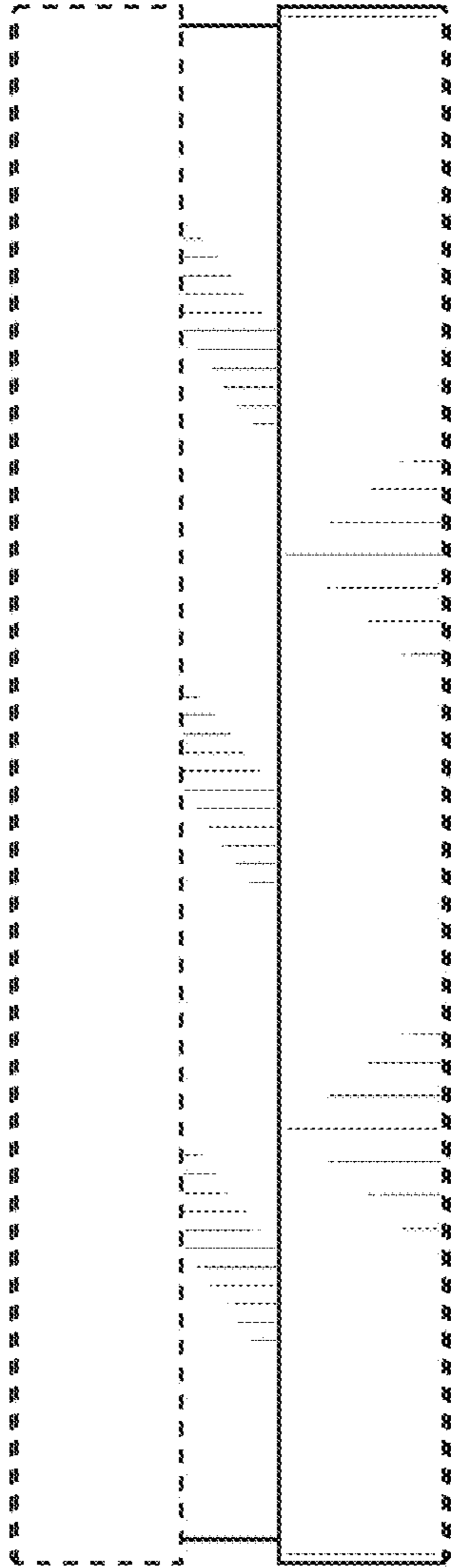


FIG. 1

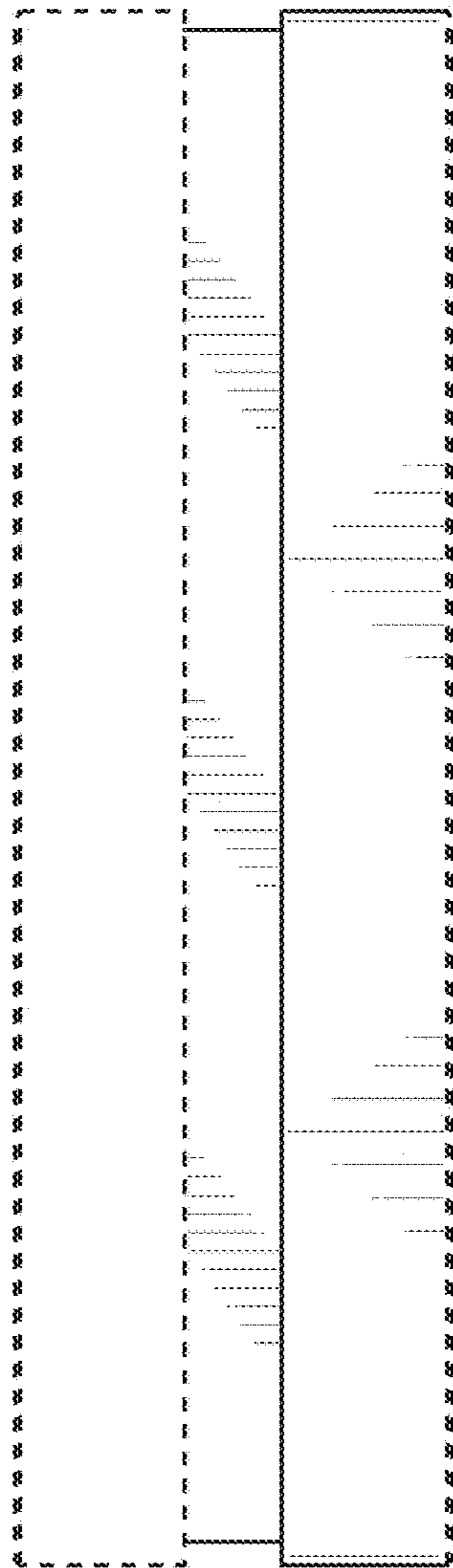


**FIG. 2**

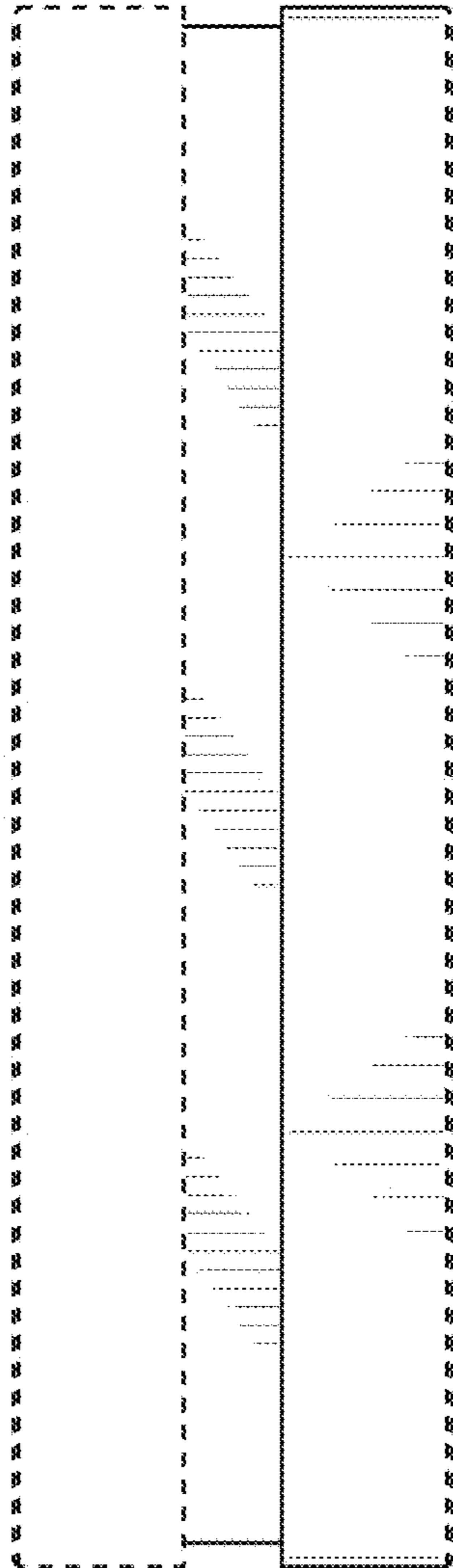


**FIG. 3**

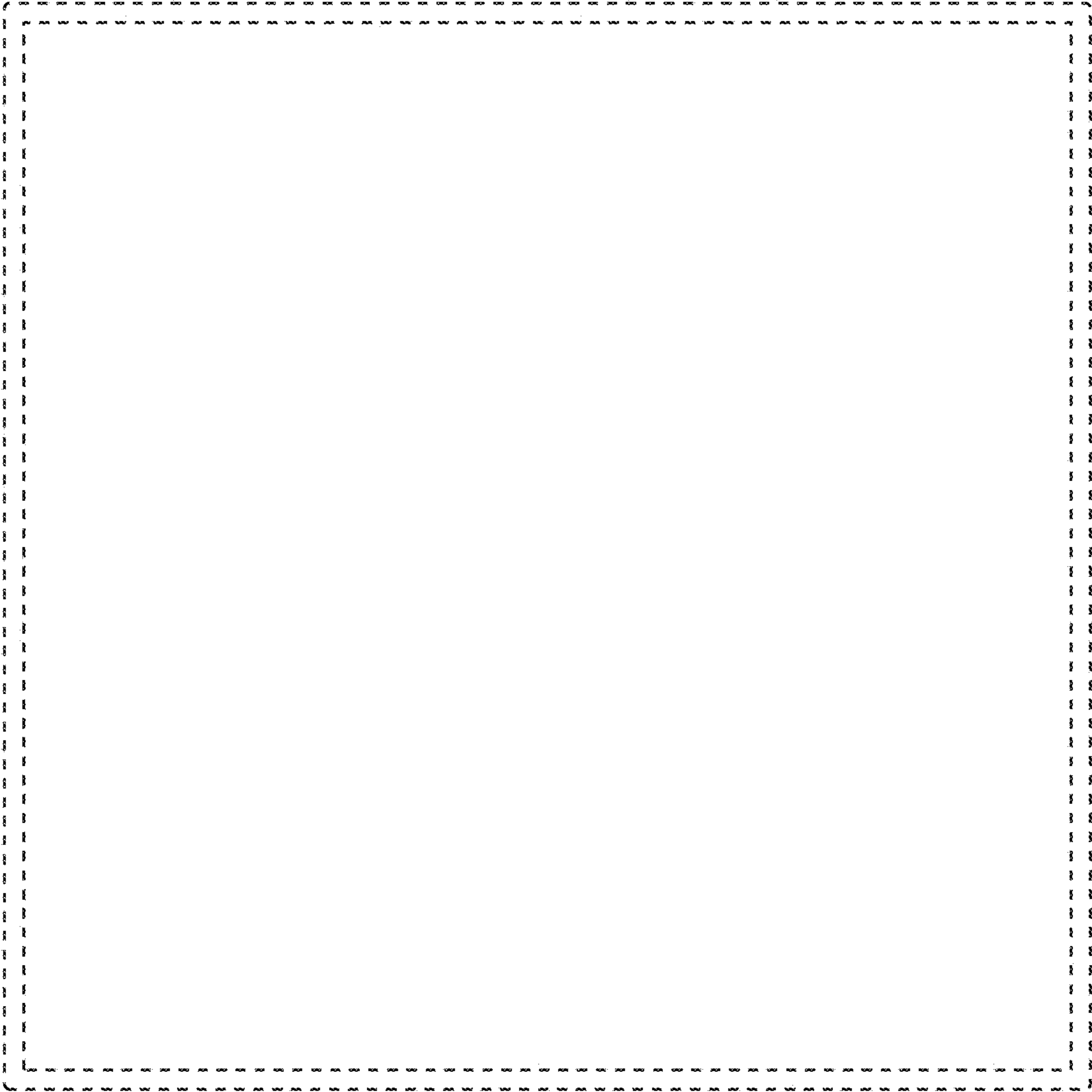




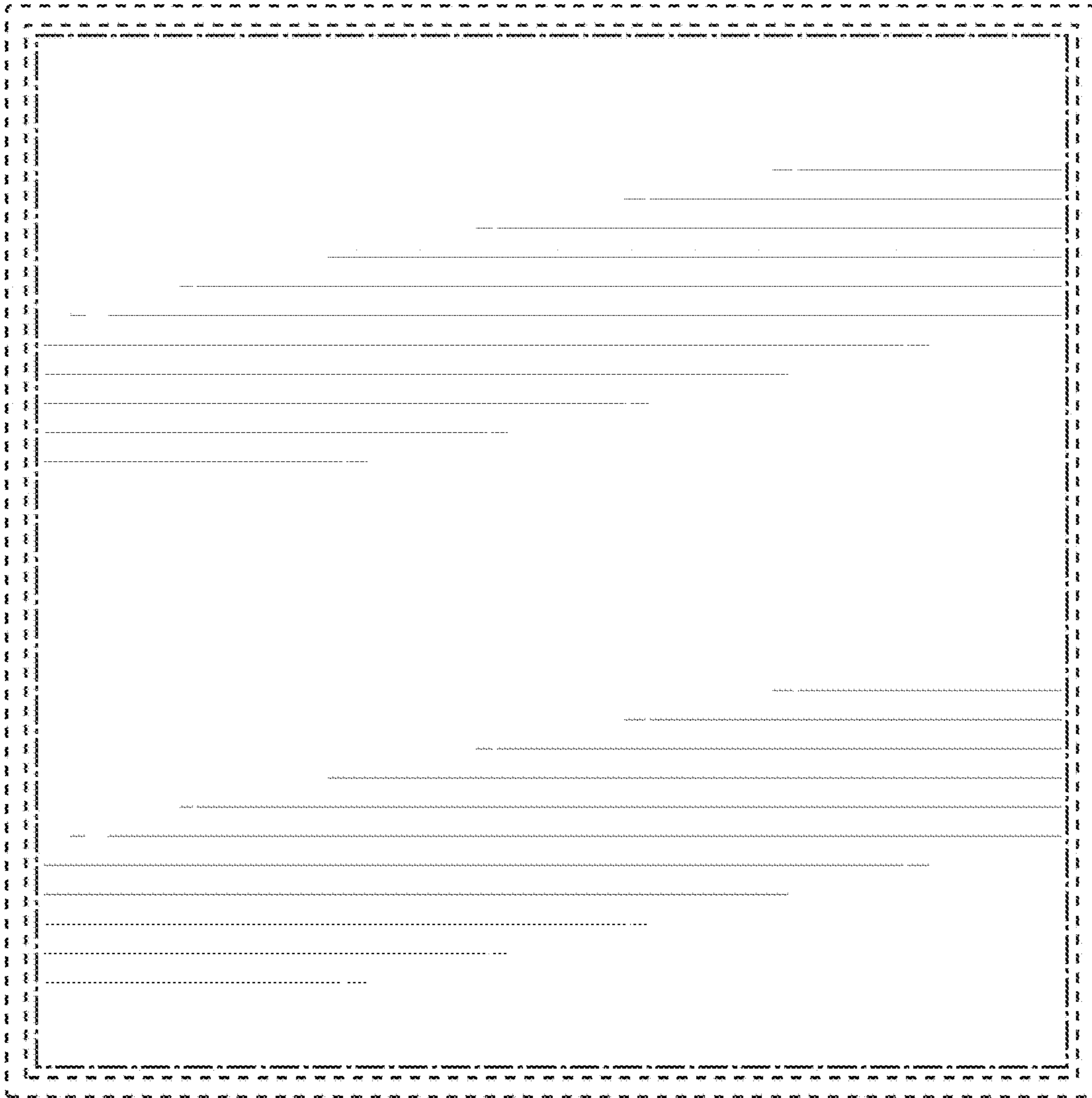
**FIG. 4**



**FIG. 5**



**FIG. 6**



**FIG. 7**

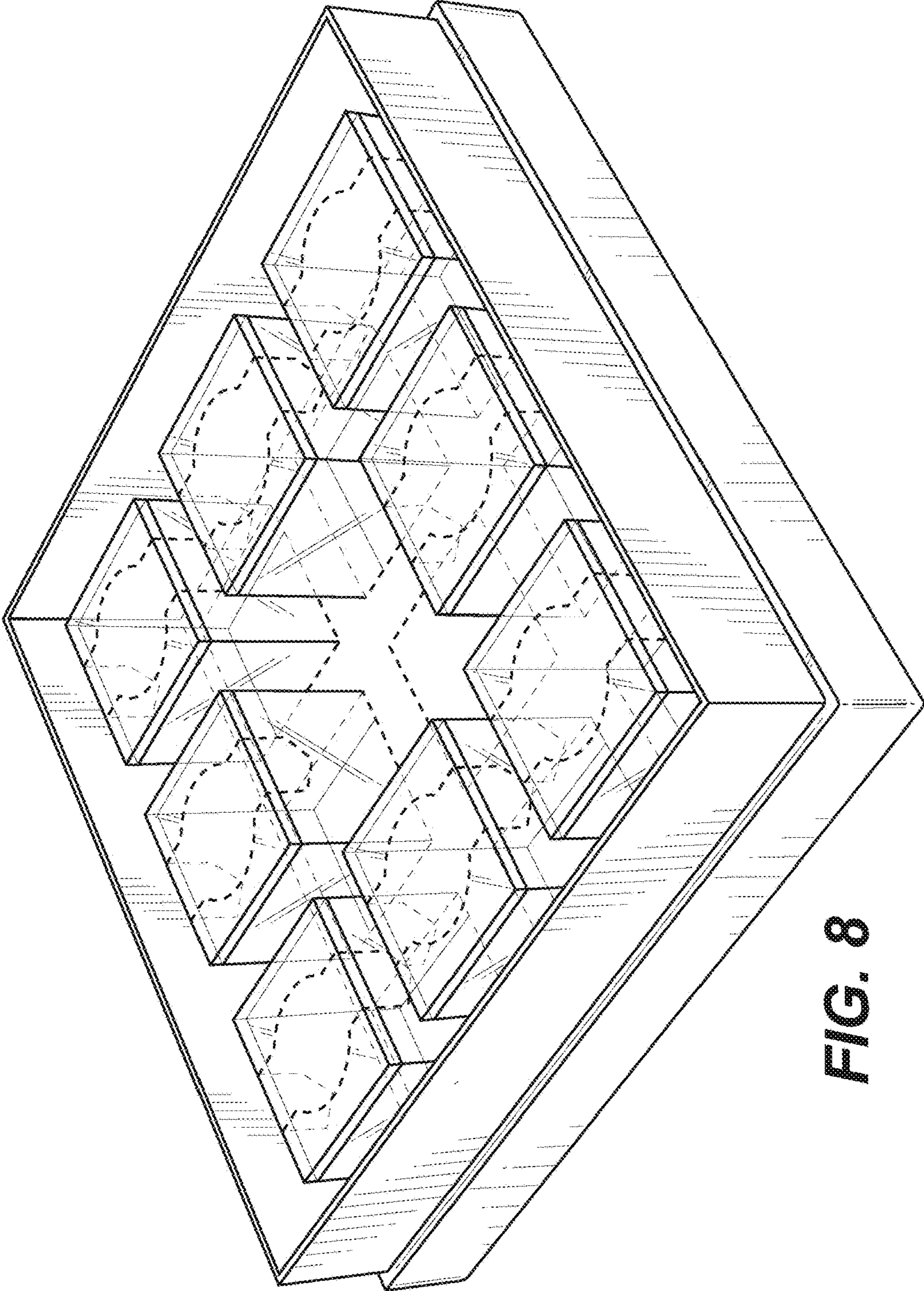
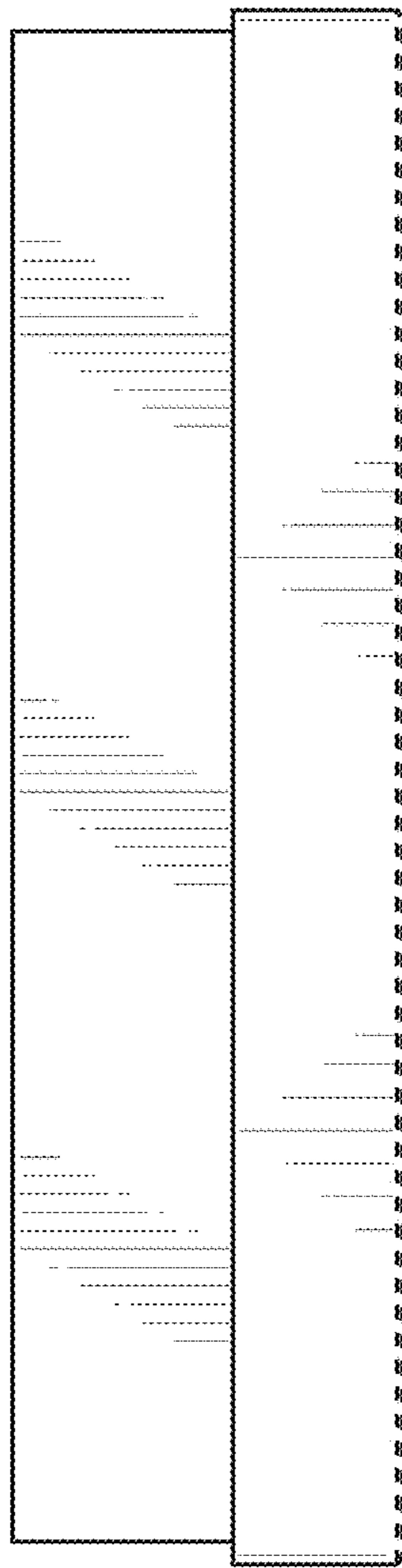
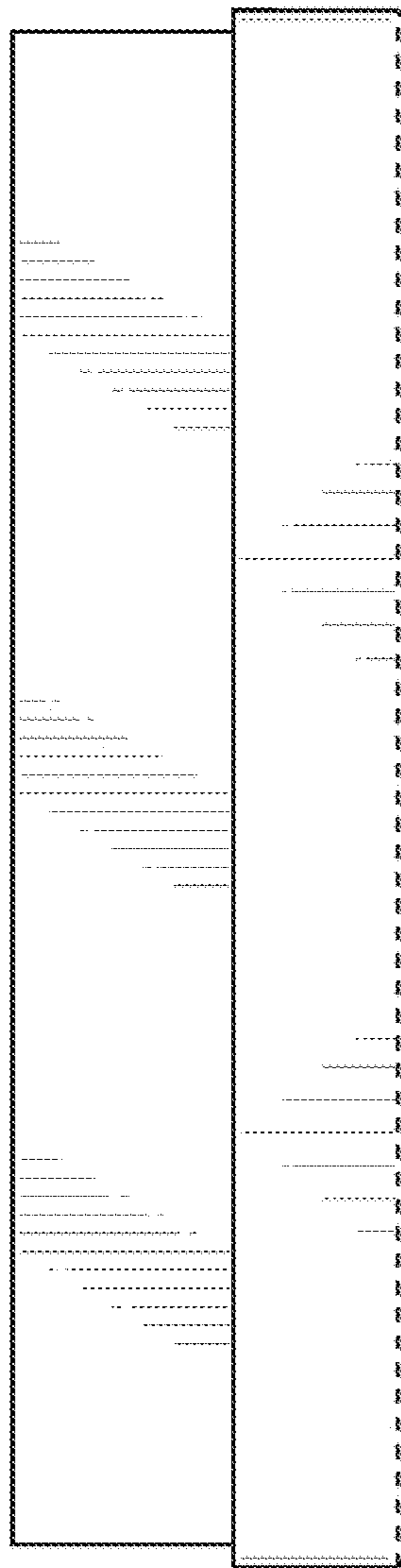


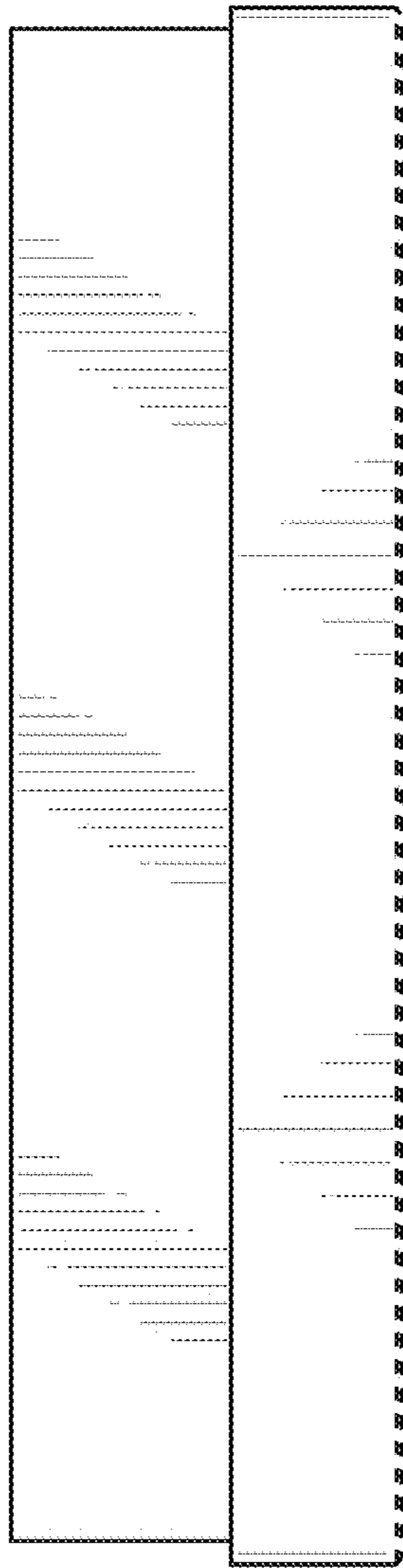
FIG. 8



**FIG. 9**

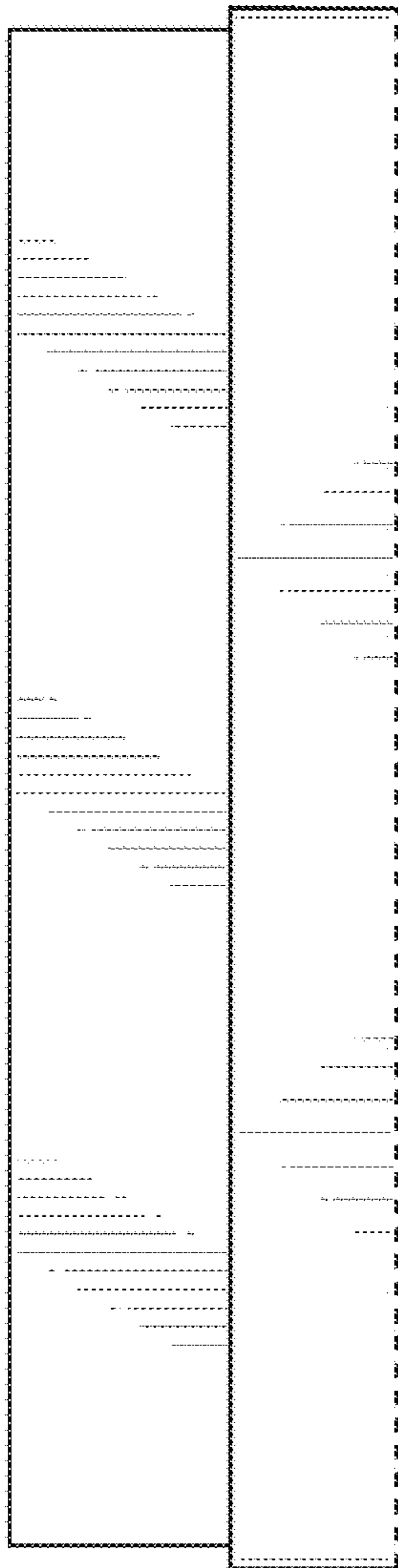


**FIG. 10**

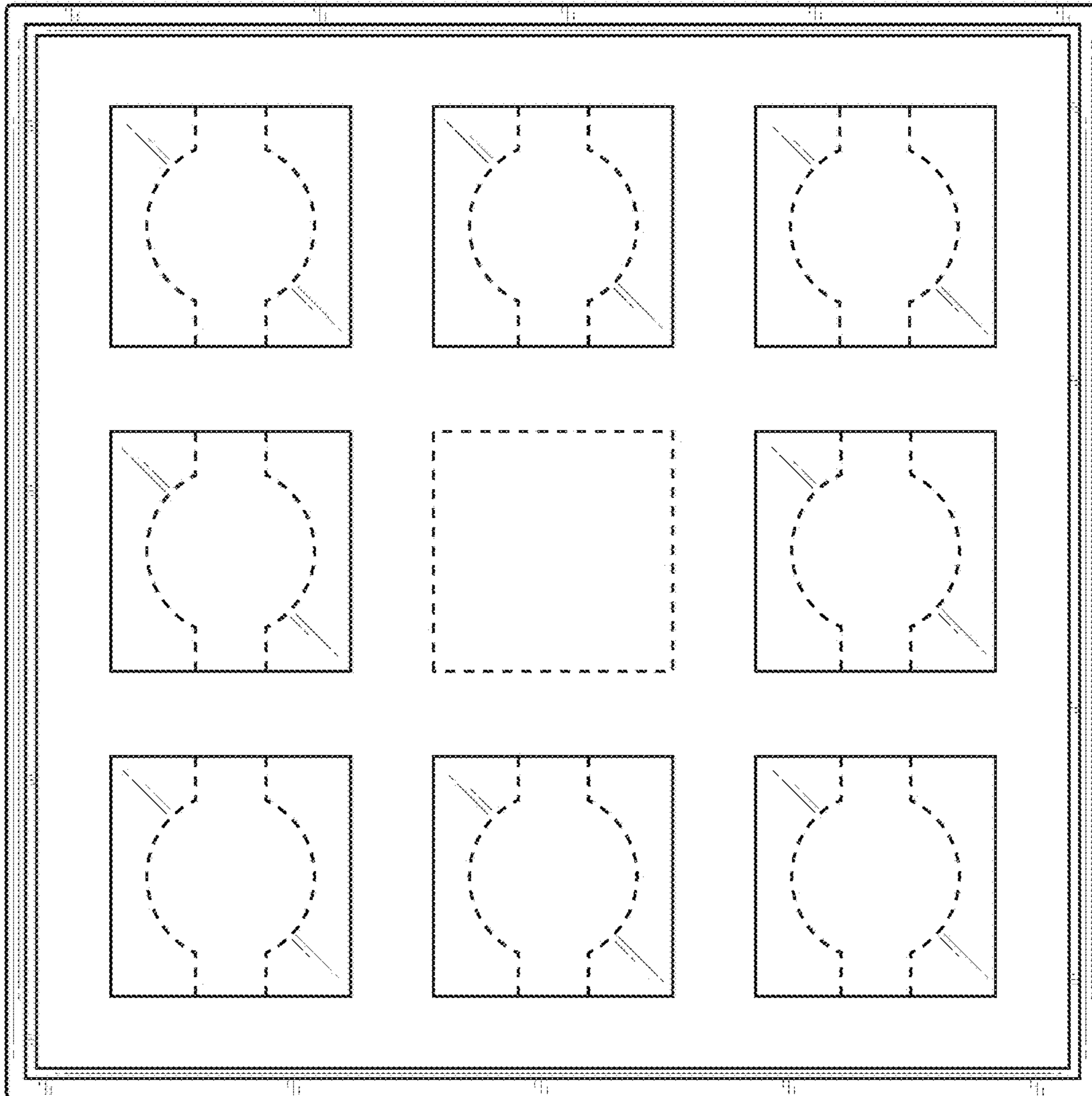


**FIG. 11**

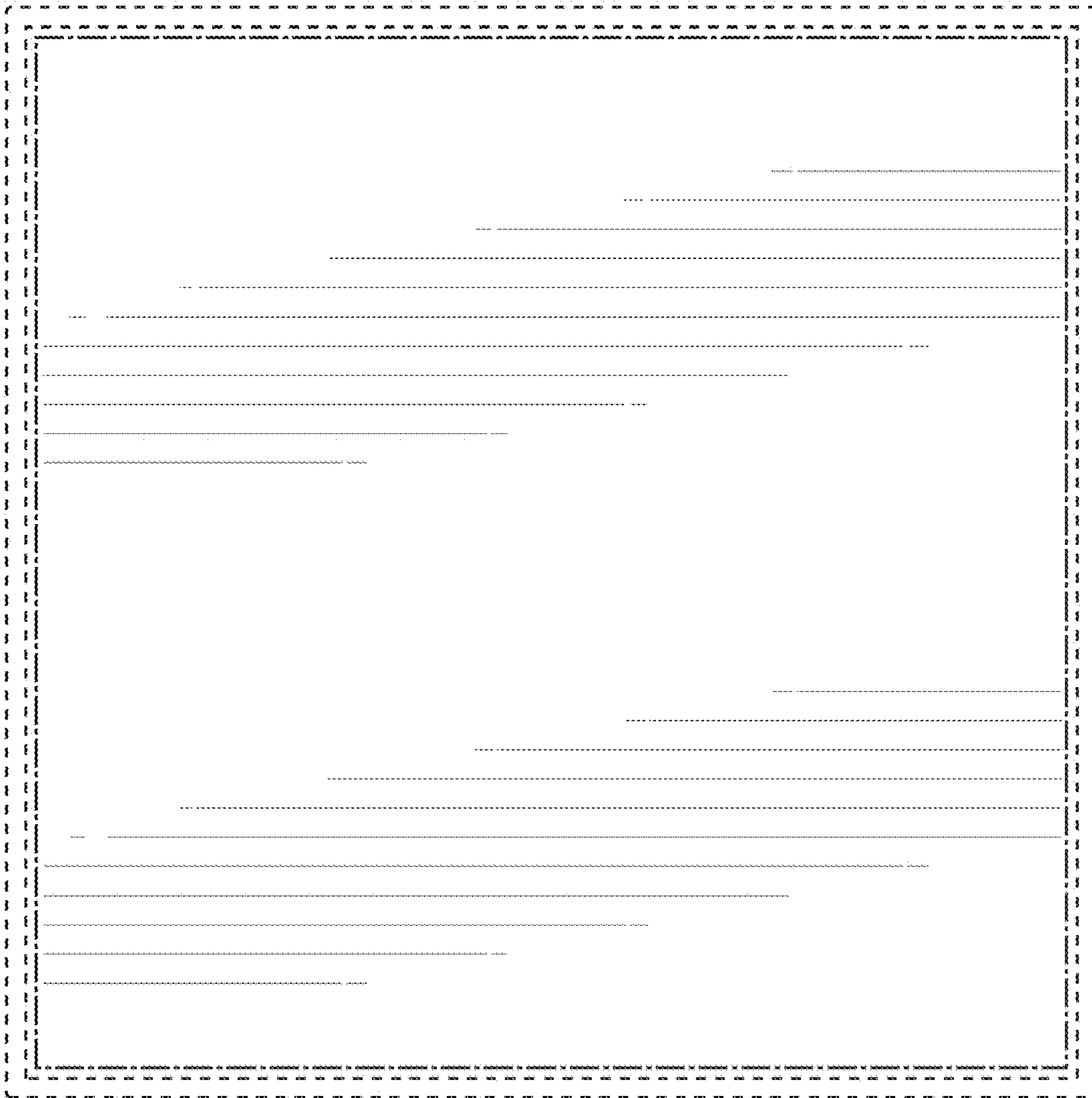




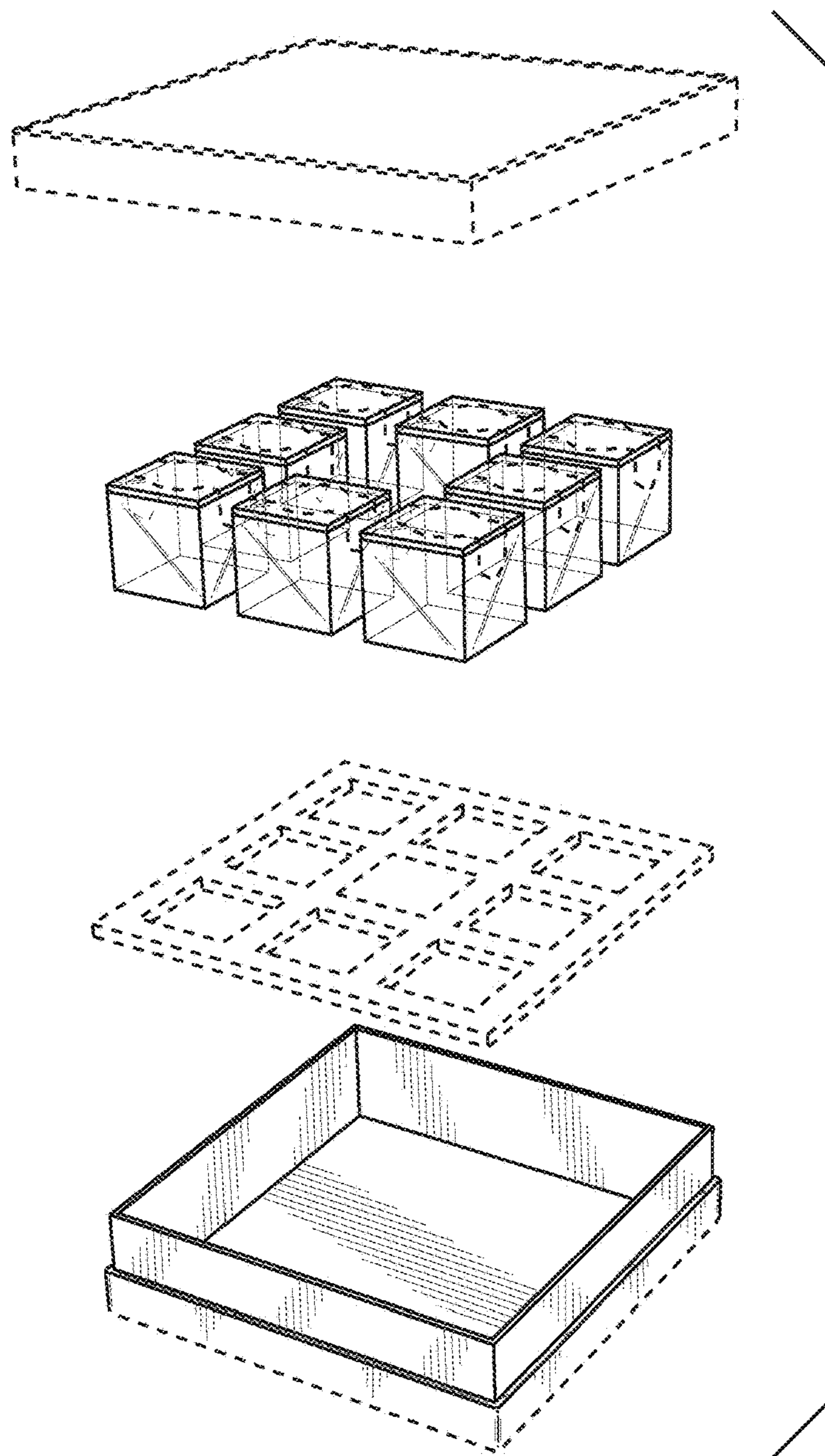
**FIG. 12**



**FIG. 13**



**FIG. 14**



**FIG. 15**