



US00D844433S

(12) **United States Design Patent** (10) **Patent No.:** **US D844,433 S**  
**Hall et al.** (45) **Date of Patent:** **\*\* Apr. 2, 2019**

(54) **BOTTLE**

FOREIGN PATENT DOCUMENTS

(71) Applicant: **Monster Energy Company**, Corona, CA (US)  
(72) Inventors: **Mark Hall**, Corona, CA (US); **Scot De Lorme**, Corona, CA (US); **Brandon Dormak**, Braselton, GA (US)

BG	5000214	10/2015
CN	D085480-0001	12/2014
WO	DM/073382	4/2010
WO	DM/088776	7/2015
WO	DM/089482	11/2015
WO	WO D091249-0001	3/2016
WO	WO D094018-0001	9/2016

(73) Assignee: **Monster Energy Company**, Corona, CA (US)

OTHER PUBLICATIONS

(\*\*) Term: **15 Years**

Core Organic, "Perfectly Organic Fruit Infused Beverages," <http://core-hydration.com/core-organic/>, in 3 pages, apparently publically available May 2017.

(21) Appl. No.: **29/610,763**

(Continued)

(22) Filed: **Jul. 14, 2017**

*Primary Examiner* — Dana Meyrow

(51) **LOC (11) Cl.** ..... **09-01**

(74) *Attorney, Agent, or Firm* — Knobbe, Martens, Olson & Bear, LLP

(52) **U.S. Cl.**  
USPC ..... **D9/500**

(58) **Field of Classification Search**  
USPC ..... D9/500, 502–505, 516, 549, 557–558, D9/715, 719  
CPC ..... B65D 1/00; B65D 1/02; B65D 1/0223; B65D 23/00; B65D 81/00; B65D 2501/00; B65D 2501/0009  
See application file for complete search history.

(57) **CLAIM**

The ornamental design for a bottle, as shown and described.

(56) **References Cited**

**DESCRIPTION**

U.S. PATENT DOCUMENTS

2,670,868	A *	3/1954	Stover	.....	B65D 43/0222	215/46
D627,604	S *	11/2010	Eyal	.....	D7/510	
D675,100	S *	1/2013	Herbst	.....	D7/511	
D739,256	S *	9/2015	Kim	.....	D9/503	
D807,125	S *	1/2018	Seiders	.....	D7/608	
D819,410	S *	6/2018	Seiders	.....	D7/608	
D822,501	S *	7/2018	Staab	.....	D9/690	

FIG. 1 is a front view of an embodiment of a bottle of our design, the rear view being the same;  
FIG. 2 is a right-side view of the bottle of FIG. 1, the left-side view being the same;  
FIG. 3 is a top view of the bottle of FIG. 1; and  
FIG. 4 is a bottom view of the bottle of FIG. 1.  
FIG. 5 is a front view of another embodiment of a bottle of our design, the rear view being the same;  
FIG. 6 is a right-side view of the bottle of FIG. 5, the left-side view being the same;  
FIG. 7 is a top view of the bottle of FIG. 5; and,  
FIG. 8 is a bottom view of the bottle of FIG. 5.

**1 Claim, 8 Drawing Sheets**

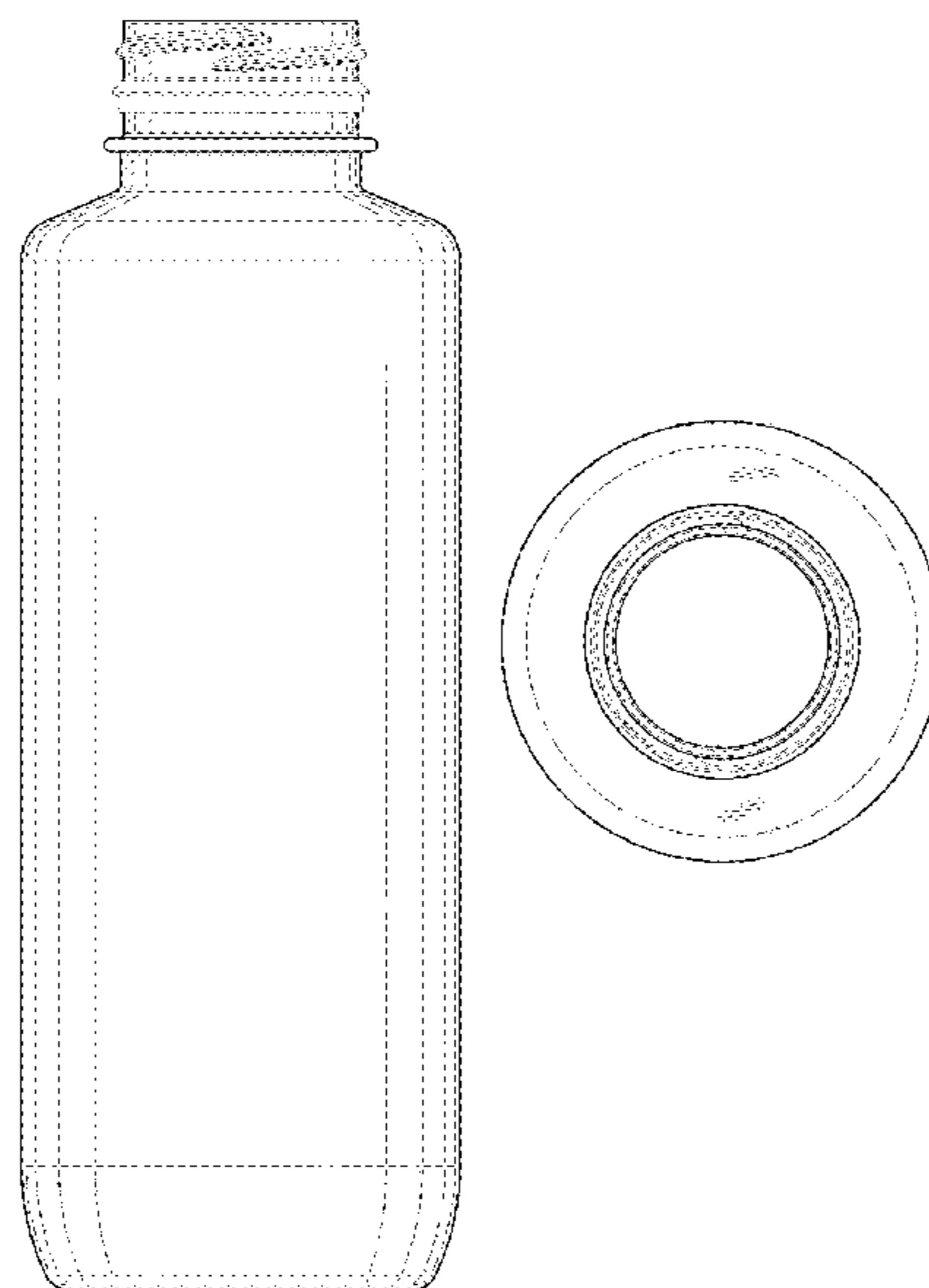

(56)

**References Cited**

OTHER PUBLICATIONS

Epica, "Epica 18-Oz. Glass Beverage Bottles, Set of 6," <https://www.amazon.com/Epica-18-Oz-Glass-Beverage-Bottles/dp/B00I0YNYSI>, in 7 pages, apparently publically available May 2017.

The Cary Company, "10 oz Clear PET Plastic Energy Shot Bottle, 38 mm 358DBJ," Part No. 68W10E, <http://www.thecarycompany.com/plastic-beverage-bottles-68w10e>, in 3 pages, apparently publically available Apr. 2016.

The Cary Company, "12 oz Clear PET Plastic Energy Shot Bottle, 38 mm 358DBJ," Part No. 68W12E, <http://www.thecarycompany.com/plastic-beverage-bottles-68w12e>, in 3 pages, apparently publically available Feb. 2016.

The Cary Company, "Plastic Beverage Bottles—Plastic Drinking Bottles You'll Thirst For," <http://www.thecarycompany.com/containers/plastic/bottles/beverage>, apparently publically available May 2017.

\* cited by examiner

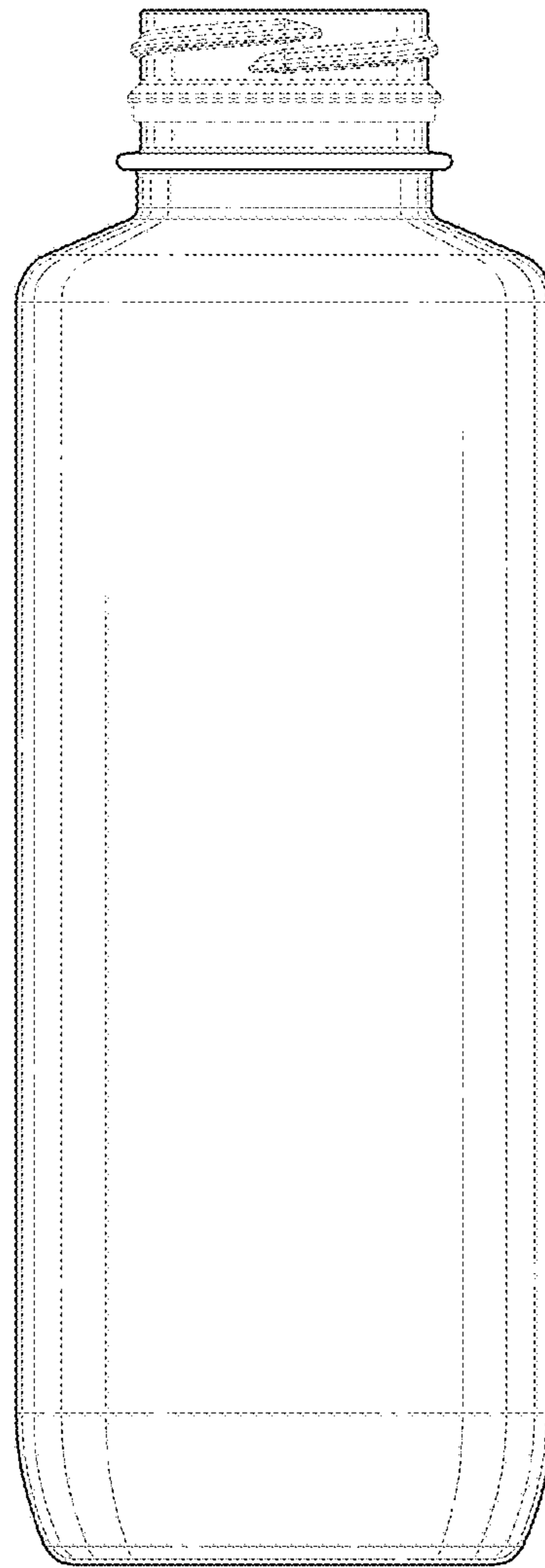

FIG. 1

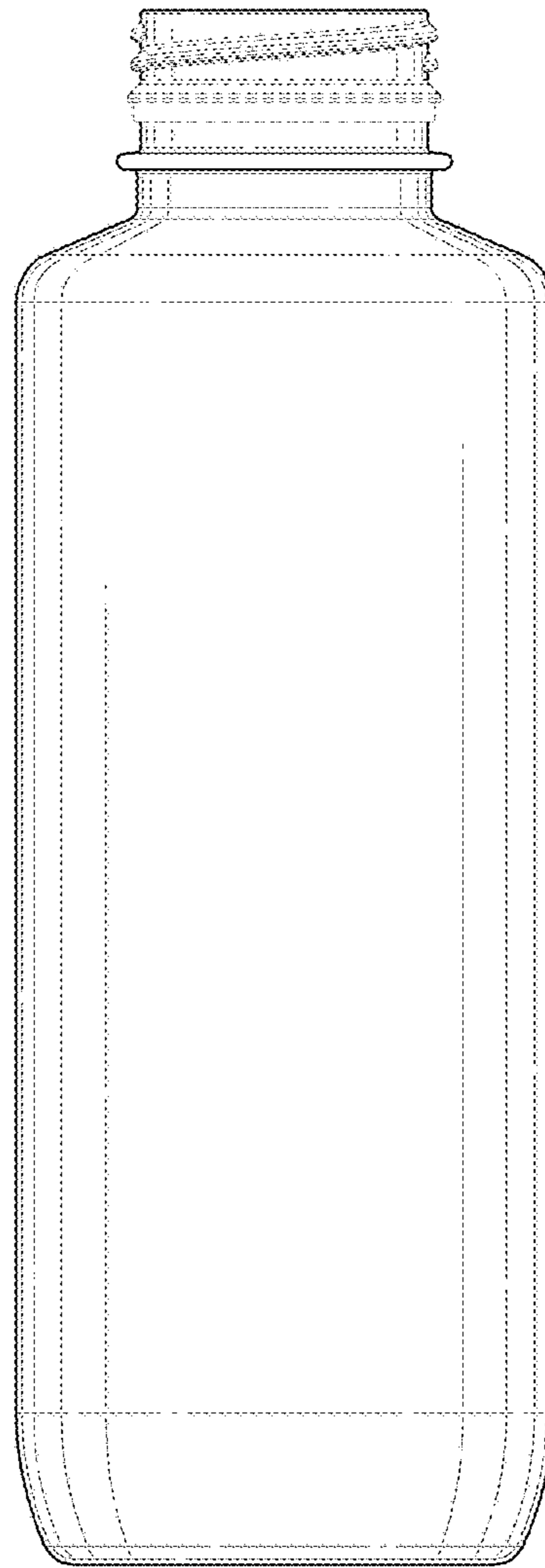

FIG. 2

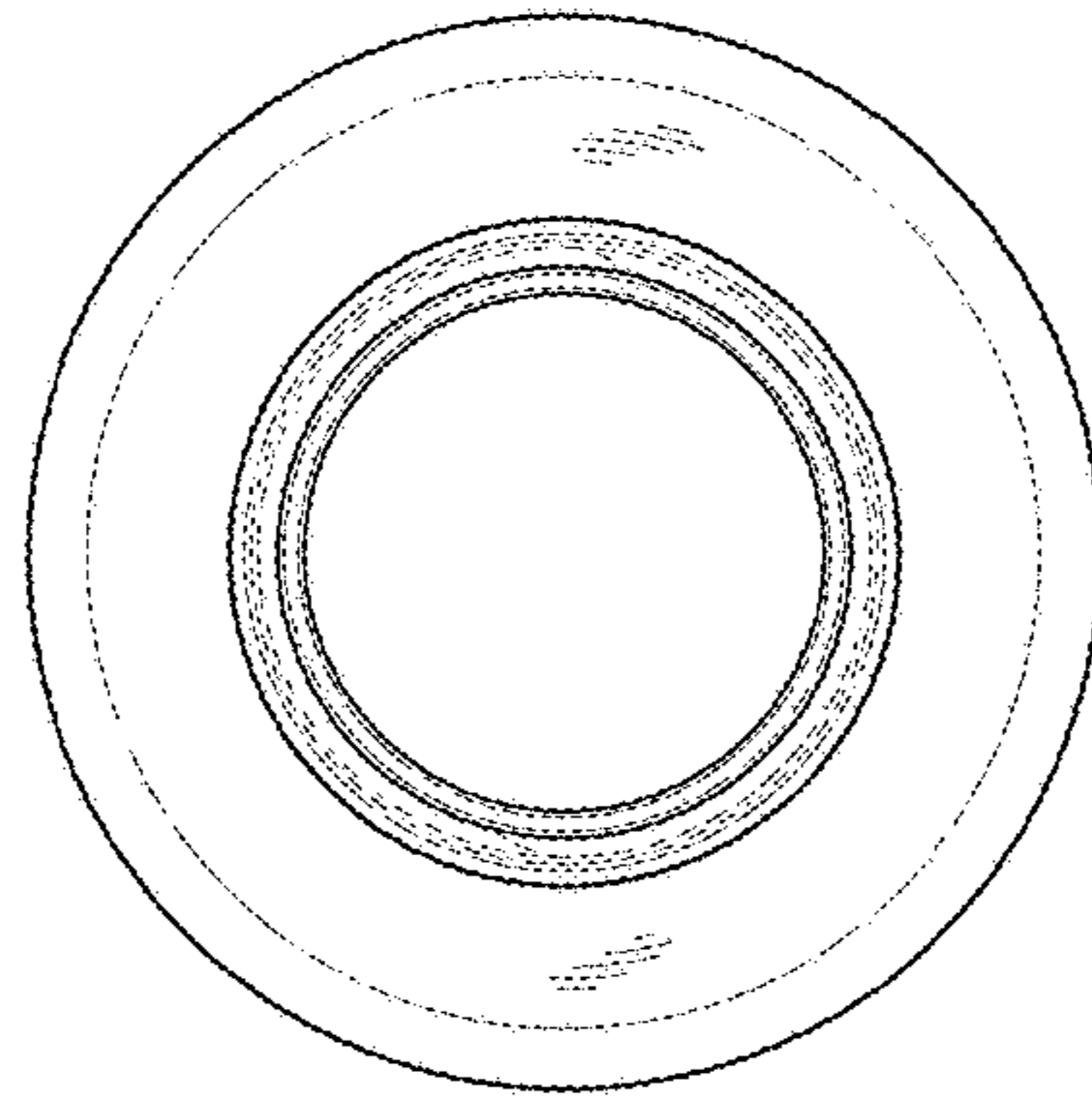

FIG. 3

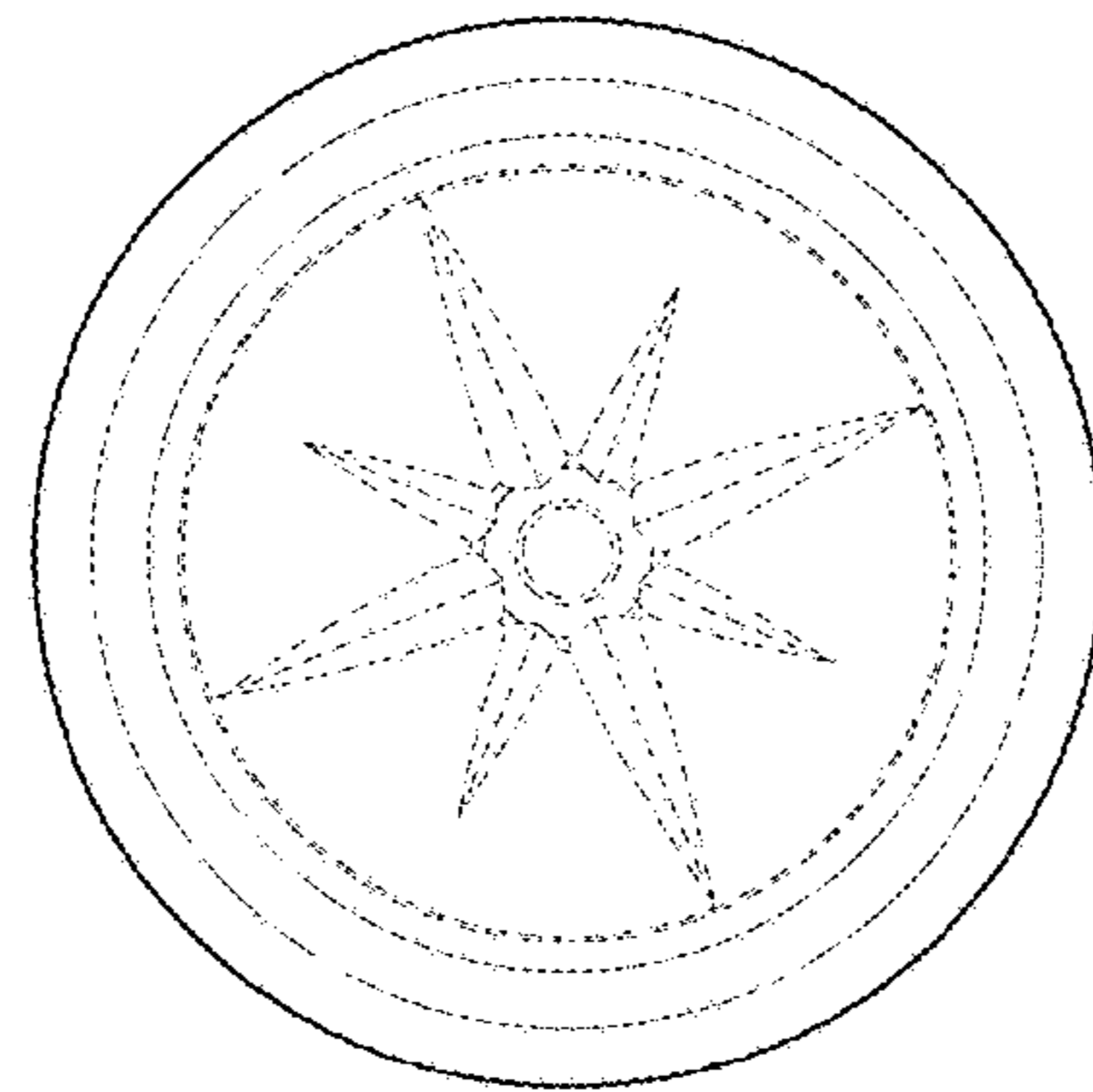

FIG. 4

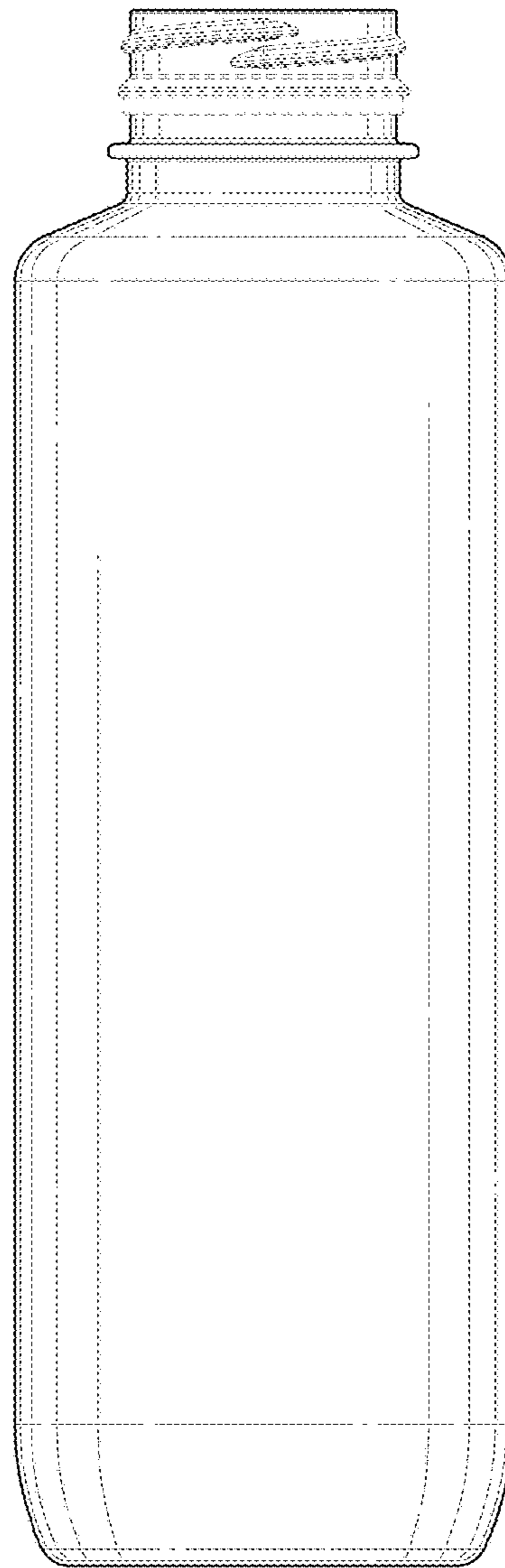

FIG. 5

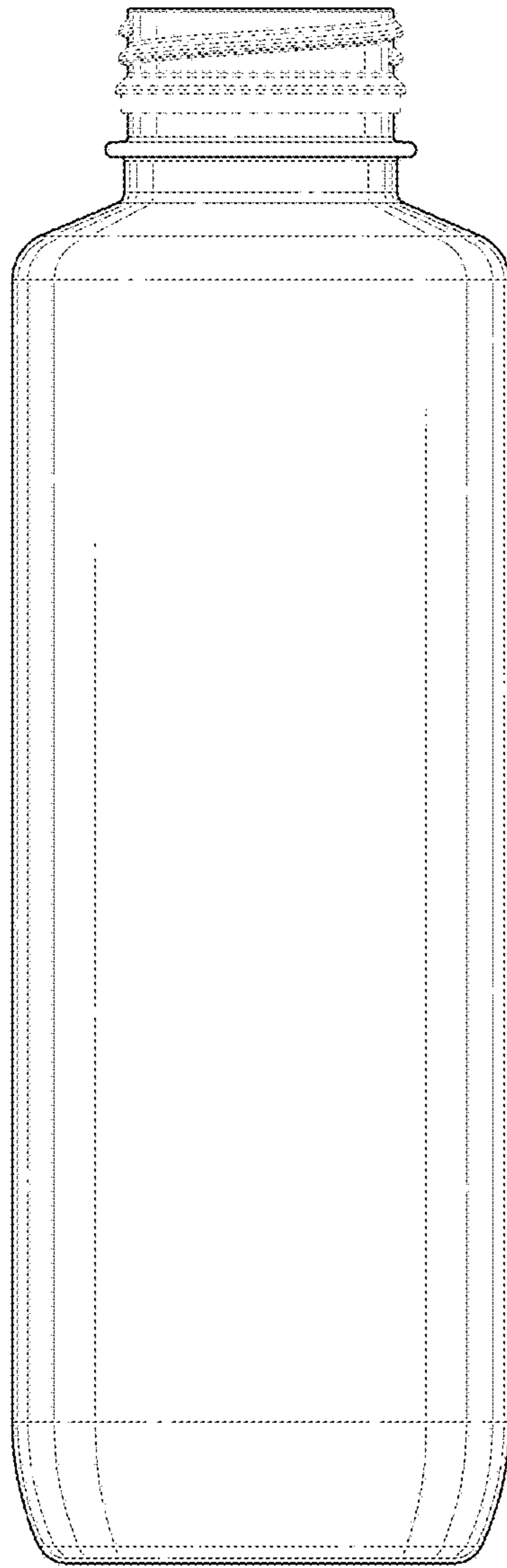

FIG. 6



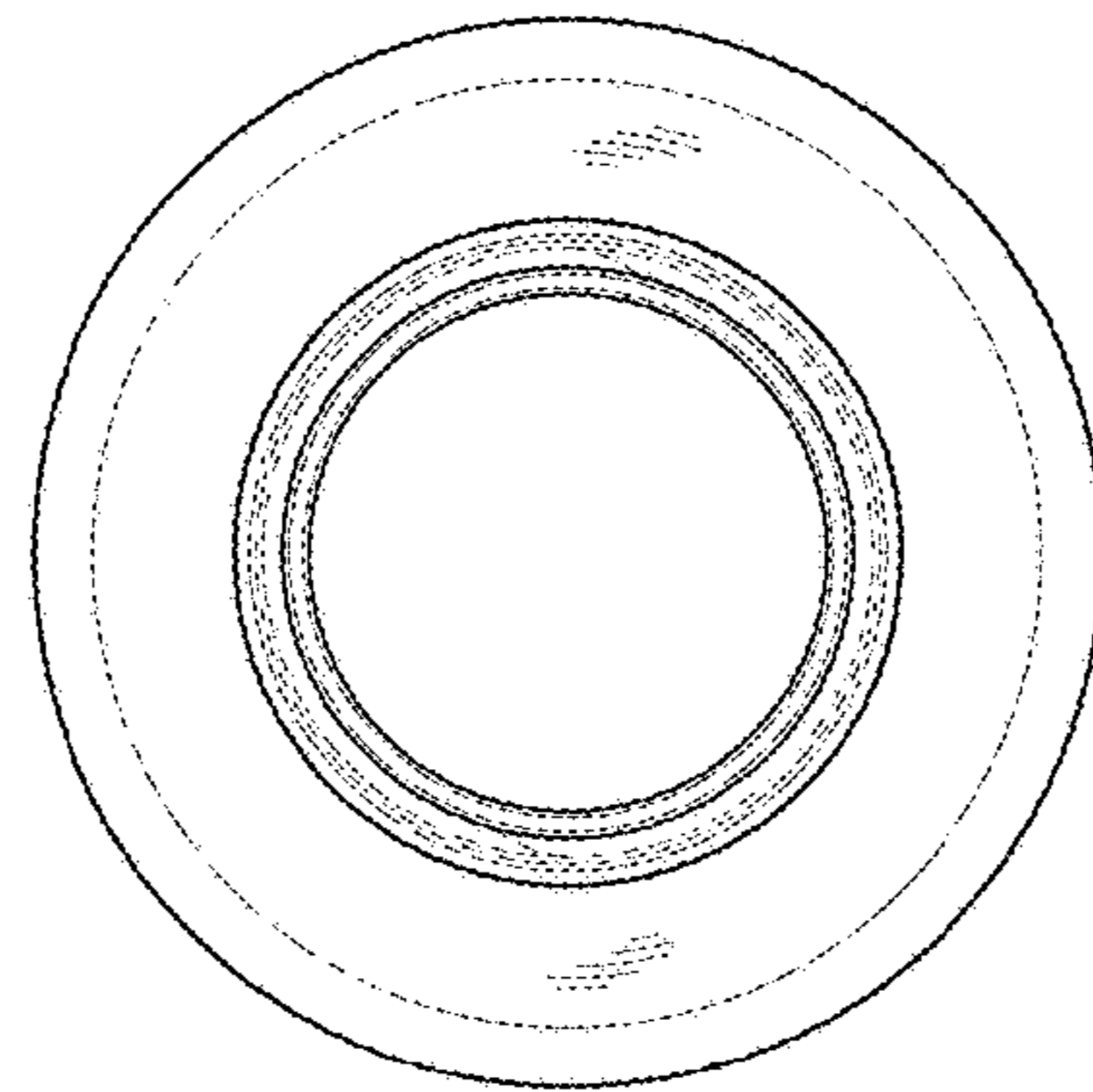

FIG. 7

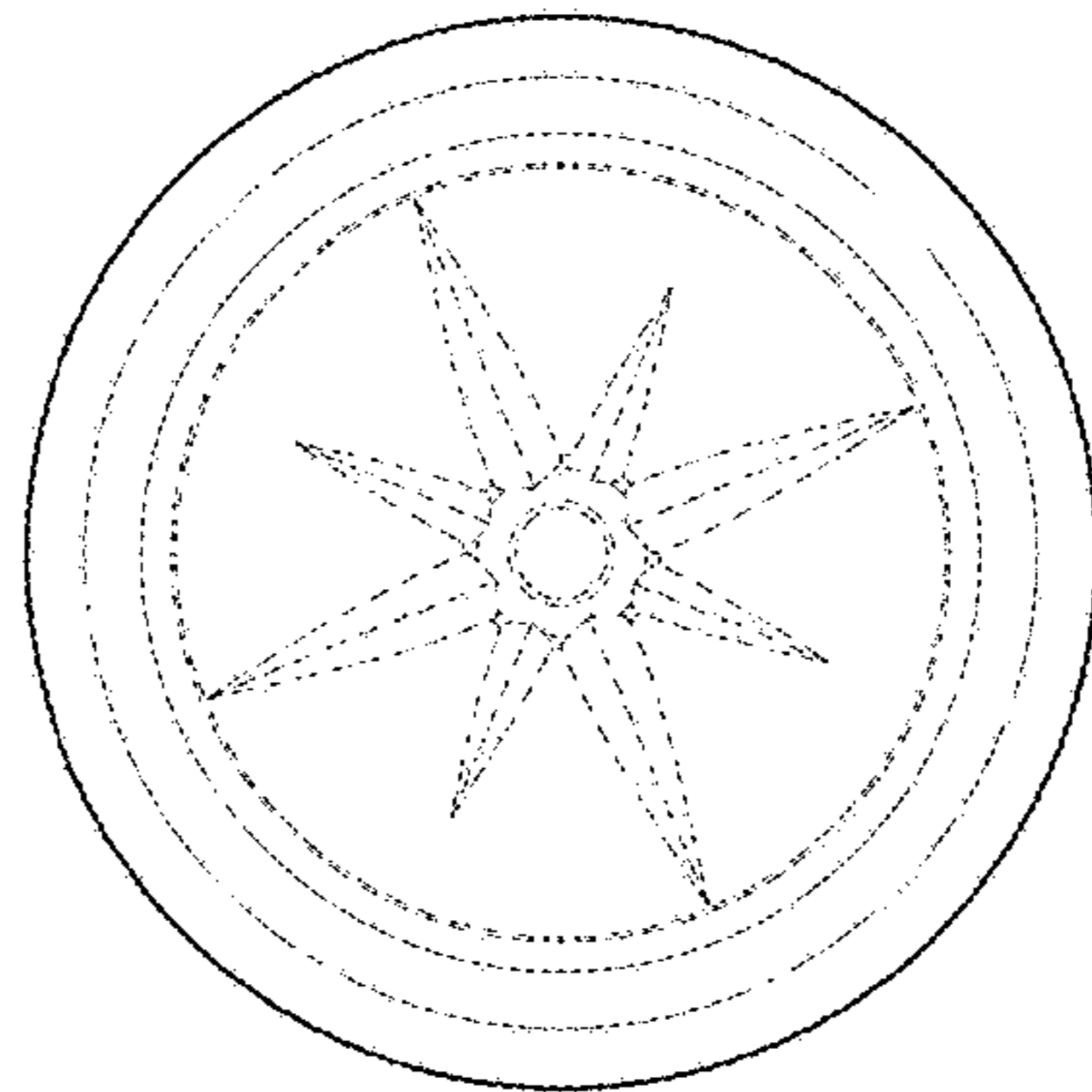

FIG. 8

UNITED STATES PATENT AND TRADEMARK OFFICE  
**CERTIFICATE OF CORRECTION**

PATENT NO. : D844,433 S  
APPLICATION NO. : 29/610763  
DATED : April 2, 2019  
INVENTOR(S) : Hall et al.

Page 1 of 1

It is certified that error appears in the above-identified patent and that said Letters Patent is hereby corrected as shown below:

On the Title Page

Item (57) description at Line 16, below "FIG. 8." insert --All features in broken line form no part of the claimed subject matter.--.

Signed and Sealed this  
Twentieth Day of August, 2019

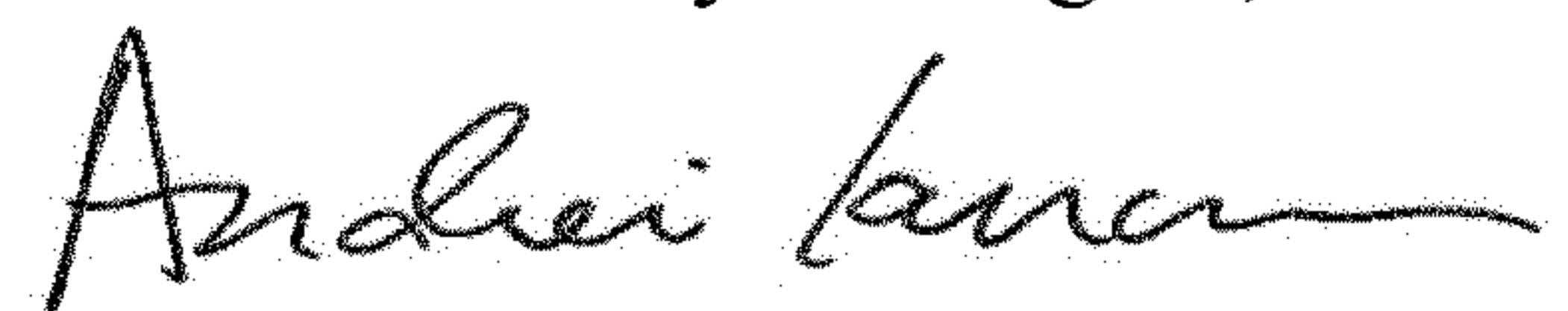

Andrei Iancu  
*Director of the United States Patent and Trademark Office*