



US00D844390S

(12) **United States Design Patent**
Reed

(10) **Patent No.:** **US D844,390 S**
(45) **Date of Patent:** **** Apr. 2, 2019**

- (54) **EATING UTENSIL**
- (71) Applicant: **Max W. Reed**, Niwot, CO (US)
- (72) Inventor: **Max W. Reed**, Niwot, CO (US)
- (73) Assignee: **VISTA MOUNTAIN GEAR, LLC**,
Niwot, CO (US)
- (**) Term: **15 Years**
- (21) Appl. No.: **29/631,716**
- (22) Filed: **Jan. 2, 2018**
- (51) **LOC (11) Cl.** **07-03**
- (52) **U.S. Cl.**
USPC **D7/643; D7/642; D7/653**
- (58) **Field of Classification Search**
USPC D7/401.2, 642-645, 653-664, 669,
D7/675-677, 683, 686-689, 691;
D8/107, 300-301; D22/117-118
CPC ... A01D 9/02; A01D 9/04; A01D 9/06; A47G
21/00; A47G 21/004; A47G 21/005;
A47G 21/02; A47G 21/023; A47G 21/04;
A47G 21/06; A47G 21/061; A47G 21/08;
A47G 21/10; A47G 21/103; A47J 43/28;
A47J 43/281; A47J 43/282; A61F 13/10;
A61J 7/0023; B25G 1/00; B25G 1/01;
B25G 1/02; B25G 3/00; B65D 75/56;
B65D 75/563; B65D 75/566; B67B 7/00;
B67B 7/724; B67B 7/73
See application file for complete search history.

- (56) **References Cited**
U.S. PATENT DOCUMENTS
174,646 A * 3/1876 Turner et al. A47G 21/06
7/112
1,230,766 A * 6/1917 Ovens A47G 21/061
294/50.8
D107,410 S * 12/1937 Eliopoulos A47G 21/103
30/142

- 2,839,830 A * 6/1958 Neiman, Jr. A47G 21/06
30/147
- D236,416 S * 8/1975 Davis A47G 21/023
D7/686
- 4,809,435 A * 3/1989 Printz A47G 21/02
294/3
- 5,056,173 A * 10/1991 Brincat A47G 21/02
294/51
- 5,373,640 A * 12/1994 Cordeiro, Jr. A47G 21/023
294/99.2
- 5,791,053 A * 8/1998 Koong A47G 21/10
294/99.2
- D601,389 S * 10/2009 Brown D7/642
(Continued)

Primary Examiner — Ricky Pham
(74) *Attorney, Agent, or Firm* — Nicholas J. Boyarski

(57) **CLAIM**

The ornamental design for an eating utensil, as shown and described.

DESCRIPTION

FIG. 1 is a top front perspective view of an eating utensil; FIG. 2 is a bottom front perspective view of the eating utensil of FIG. 1; FIG. 3 is a top rear perspective view of the eating utensil of FIG. 1; FIG. 4 is a bottom rear perspective of the eating utensil of FIG. 1; FIG. 5 is a front view of the eating utensil of FIG. 1; FIG. 6 is a rear view of the eating utensil of FIG. 1; FIG. 7 is a left side view of the eating utensil of FIG. 1; FIG. 8 is a right side view of the eating utensil of FIG. 1; FIG. 9 is bottom view of the eating utensil of FIG. 1; FIG. 10 is top view of the eating utensil of FIG. 1; FIG. 11 is a top front perspective view of the eating utensil of FIG. 1 in an open position; and, FIG. 12 is a bottom front perspective view of the eating utensil of FIG. 1 in an open position.

1 Claim, 6 Drawing Sheets

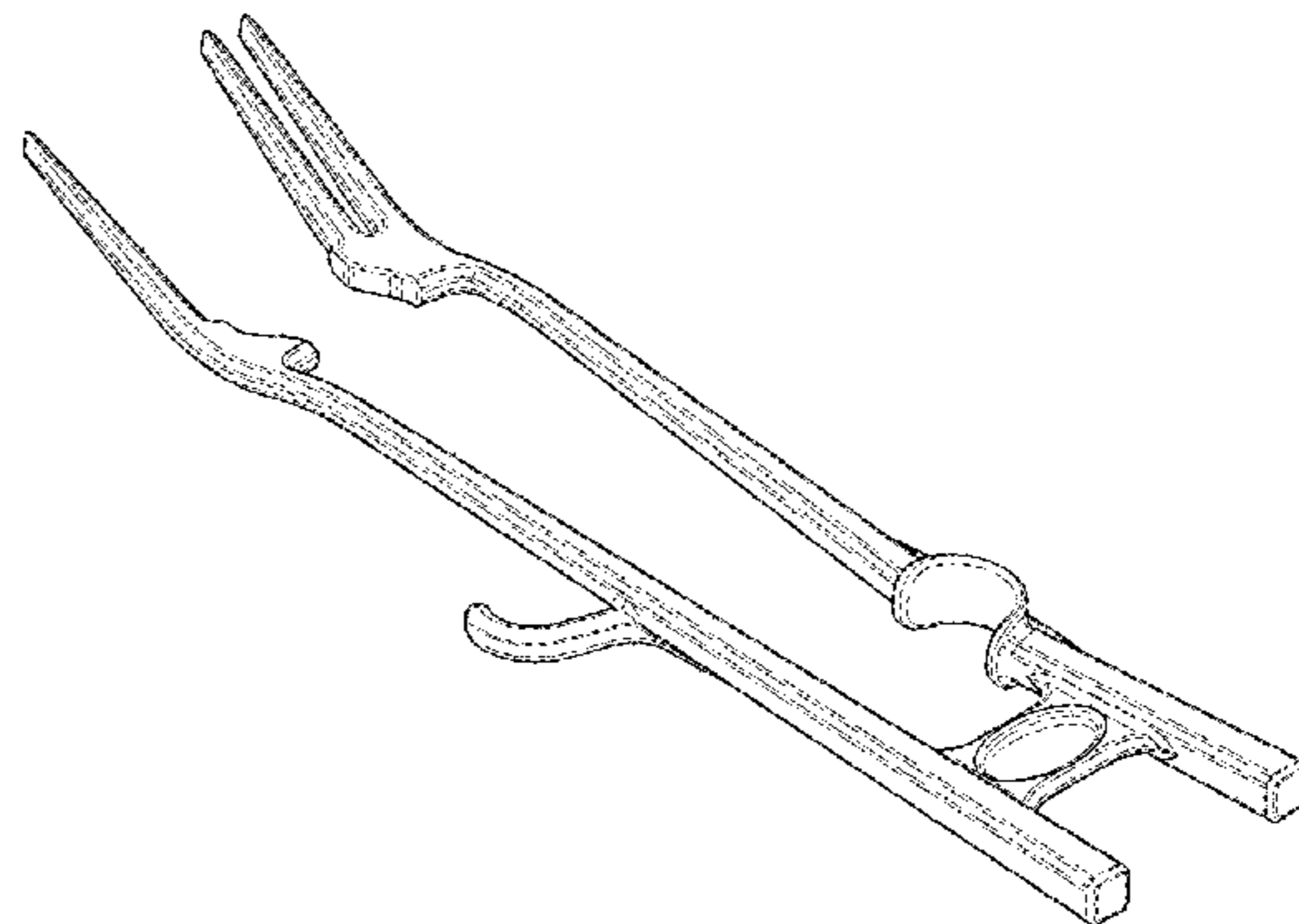
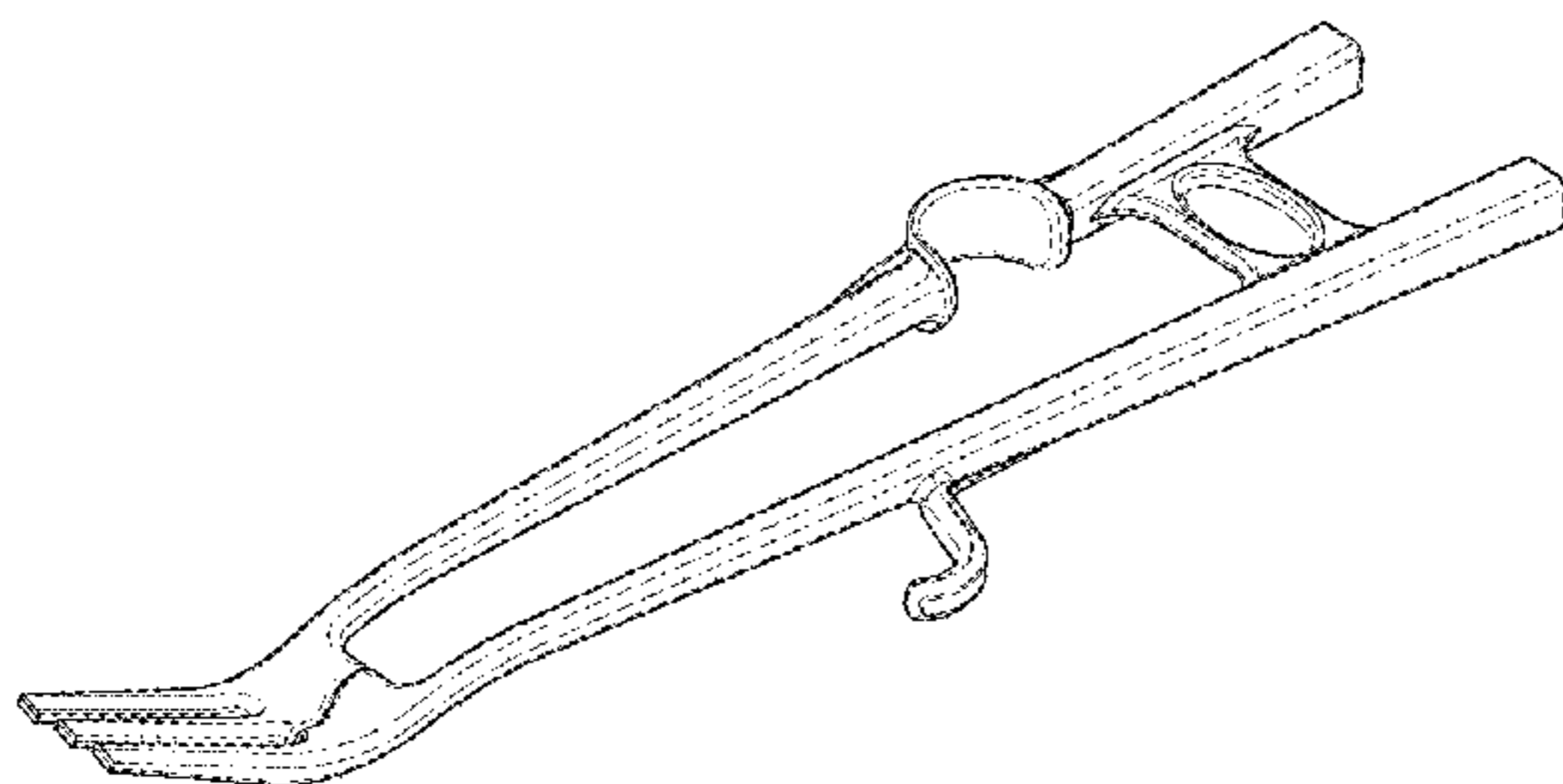

(56)

References Cited

U.S. PATENT DOCUMENTS

7,878,563 B2 * 2/2011 Beckham A47G 21/103
294/218
10,136,745 B1 * 11/2018 Reed A47G 21/02
2008/0022534 A1 * 1/2008 Kim A47G 21/02
30/142

* cited by examiner

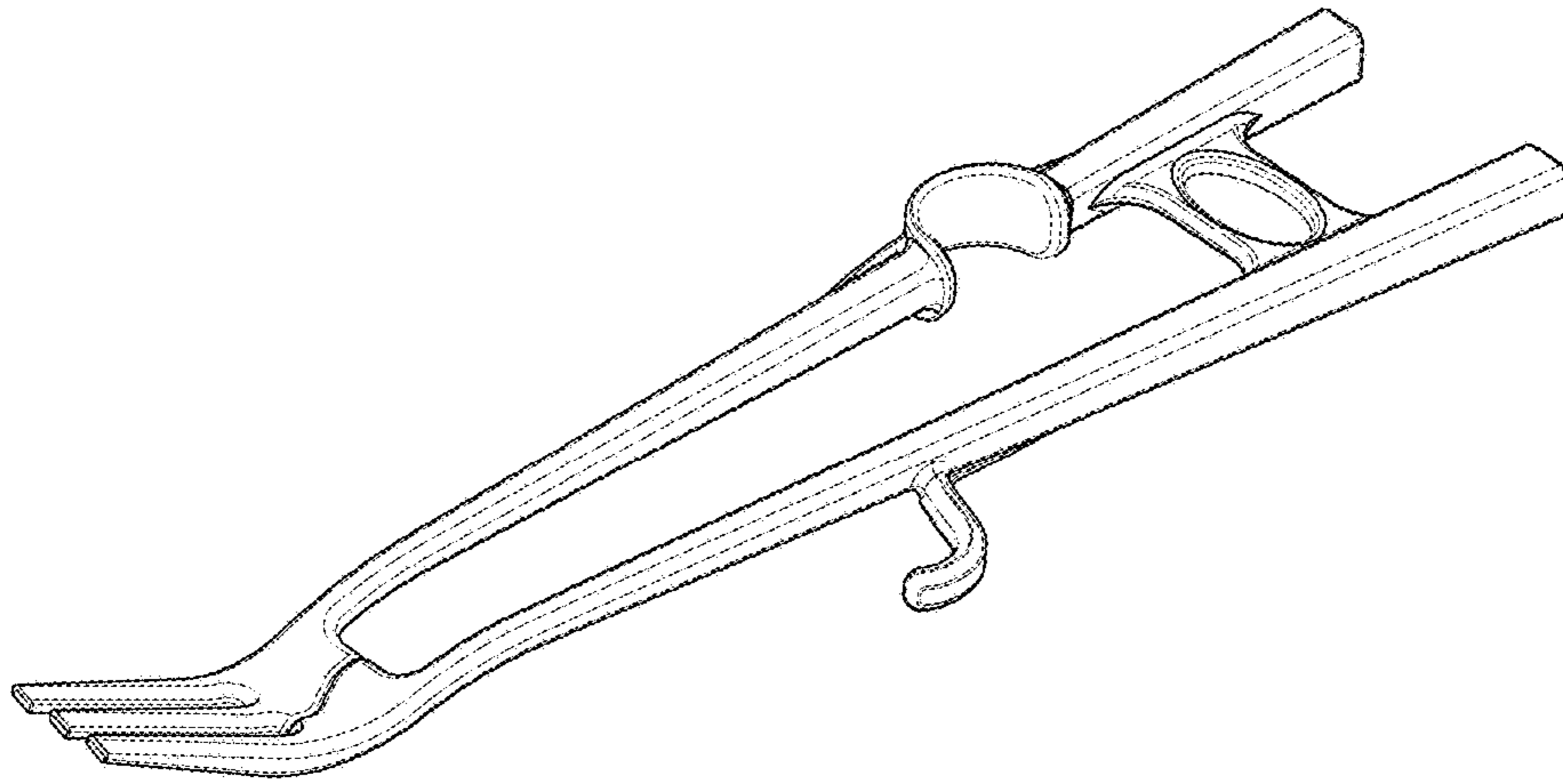

FIG. 1

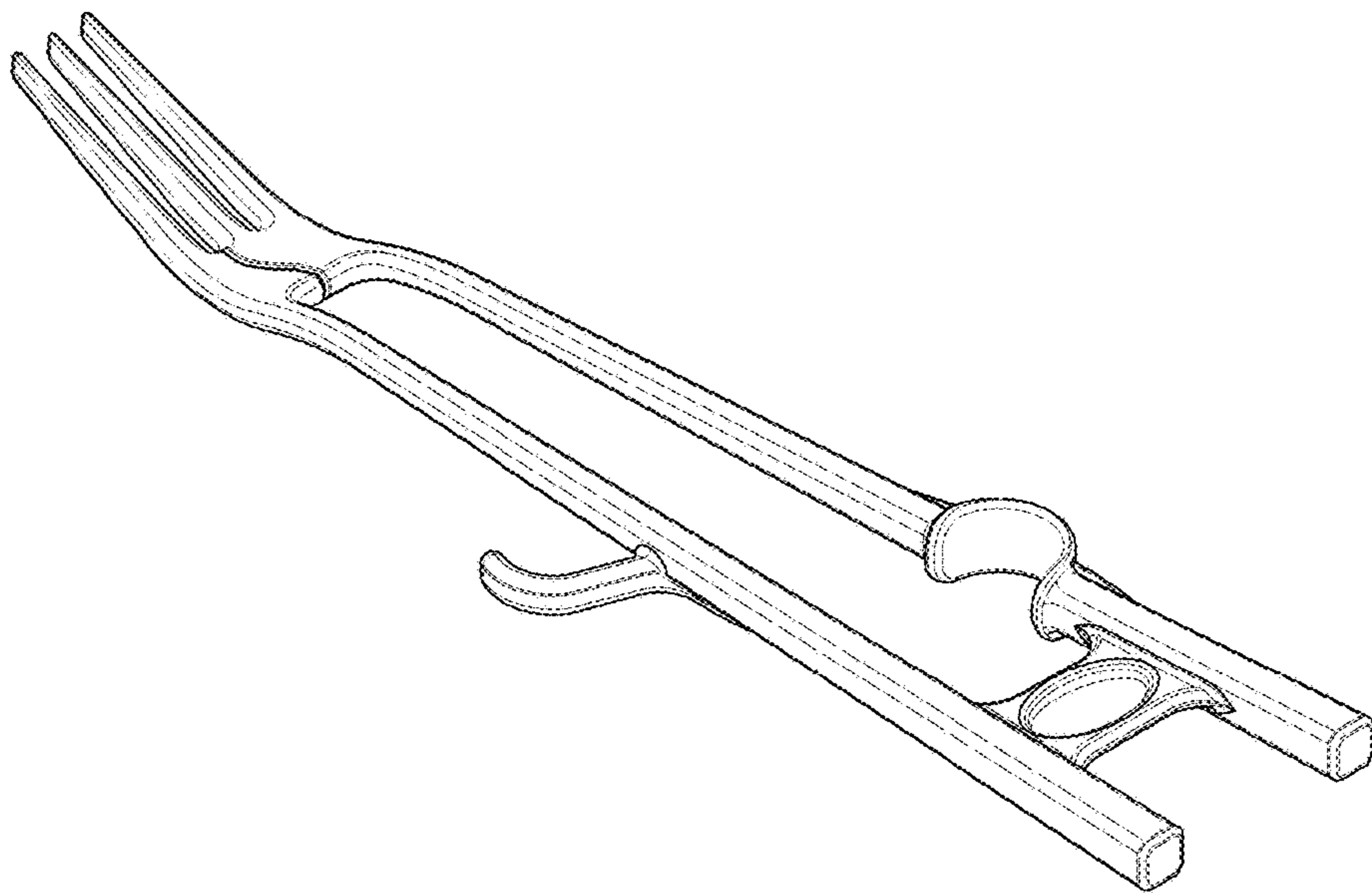

FIG. 2

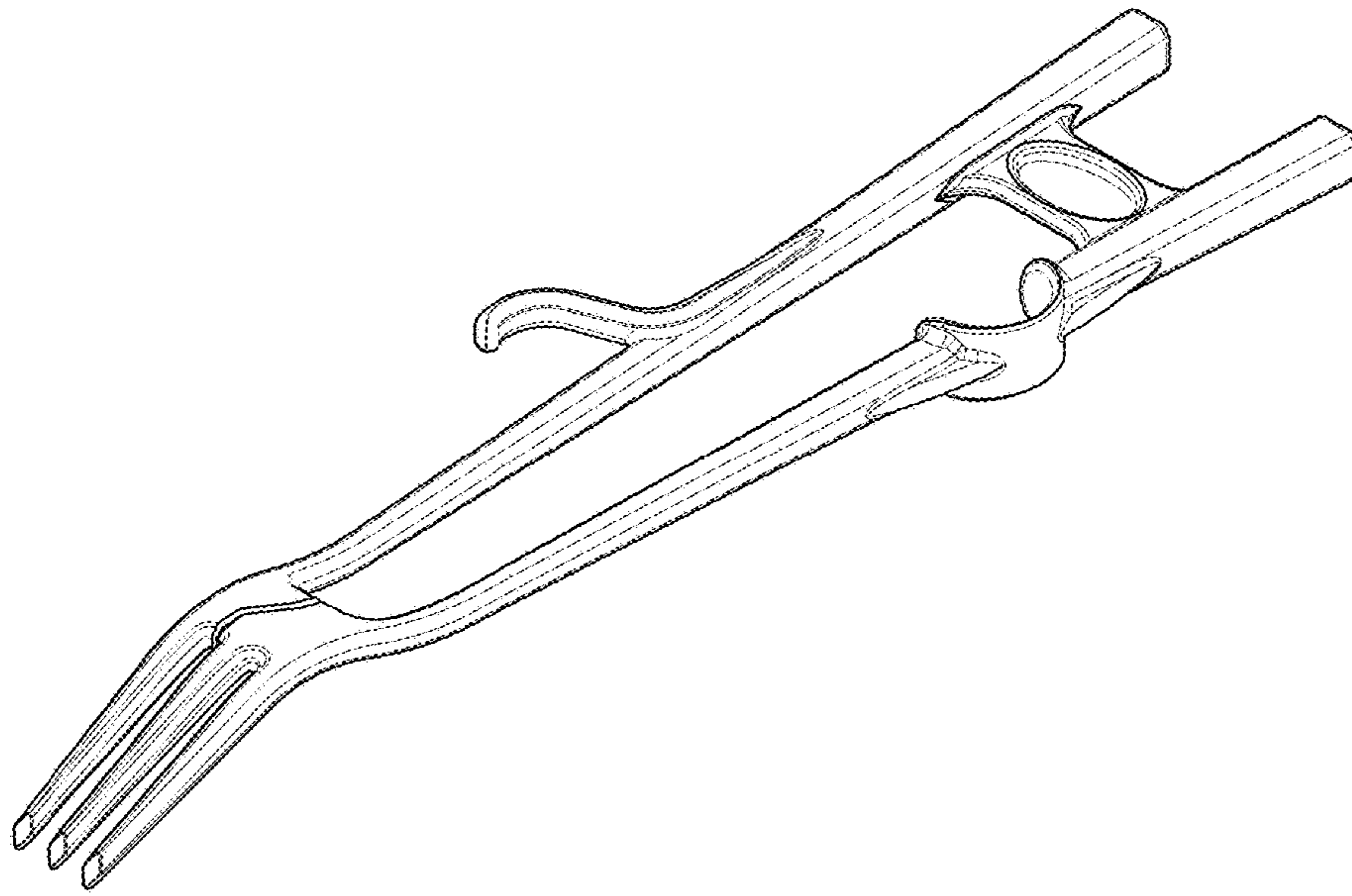

FIG. 3

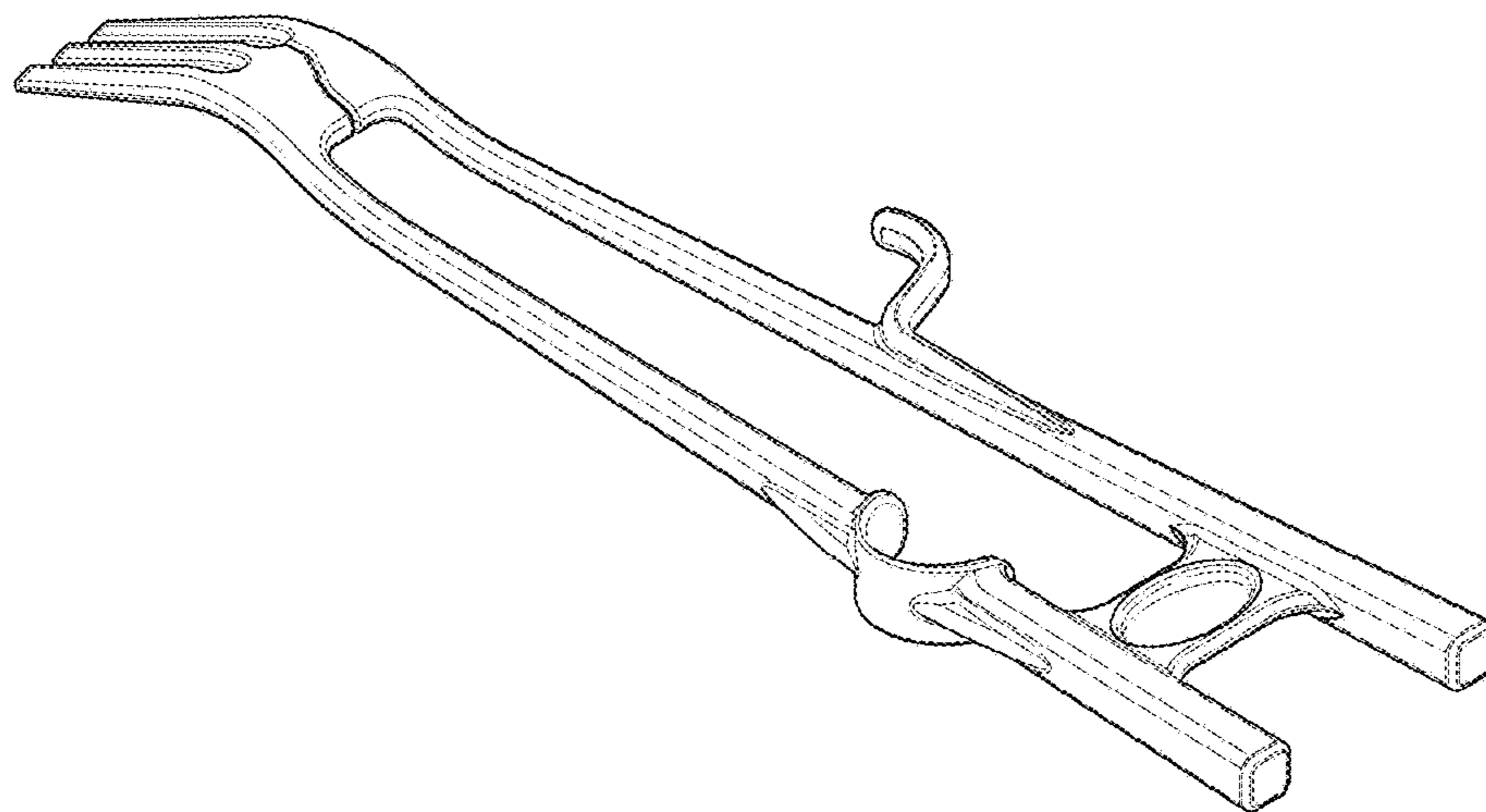

FIG. 4

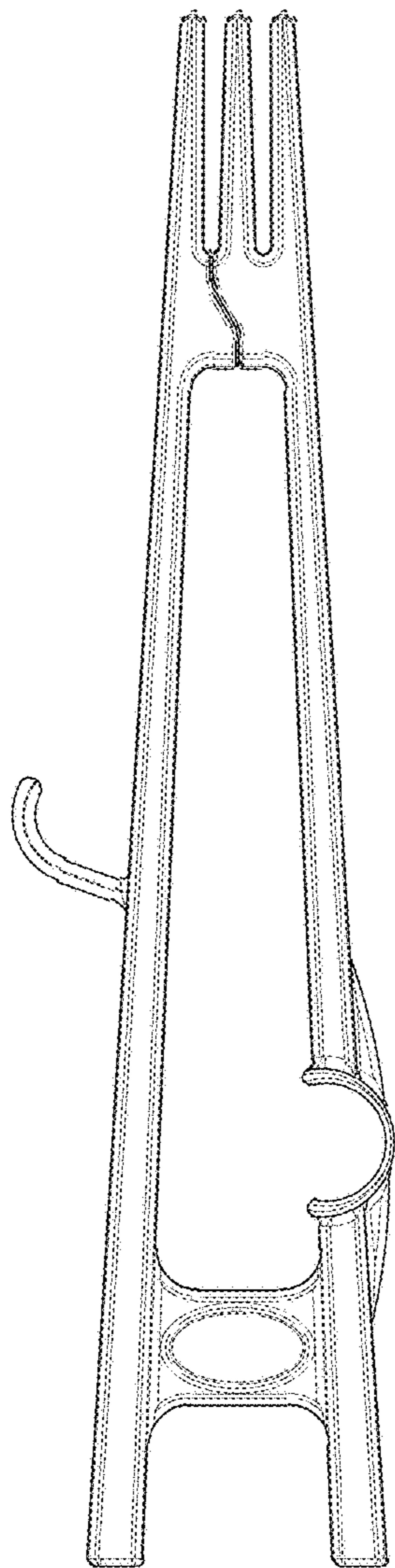

FIG. 5

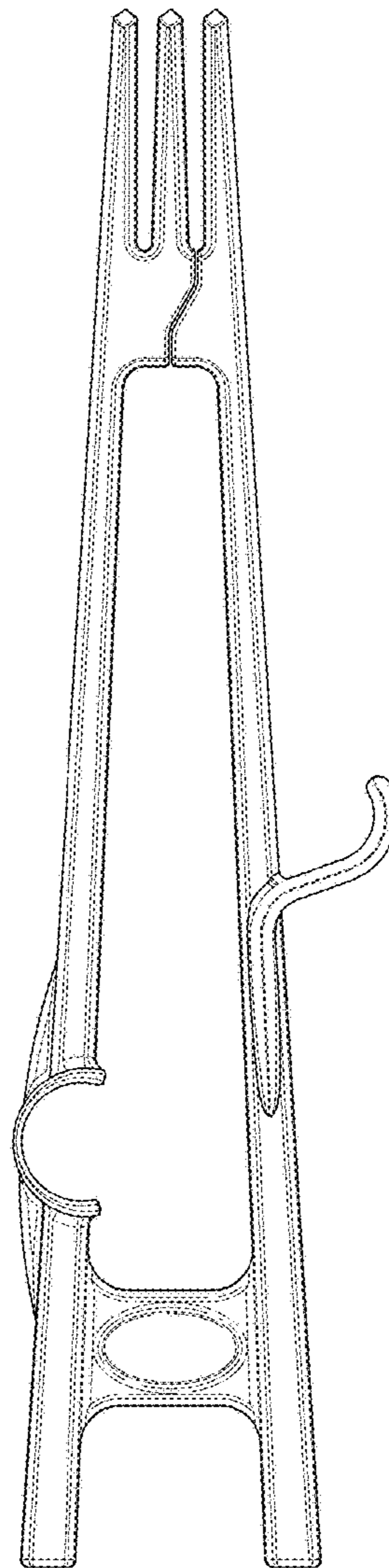

FIG. 6

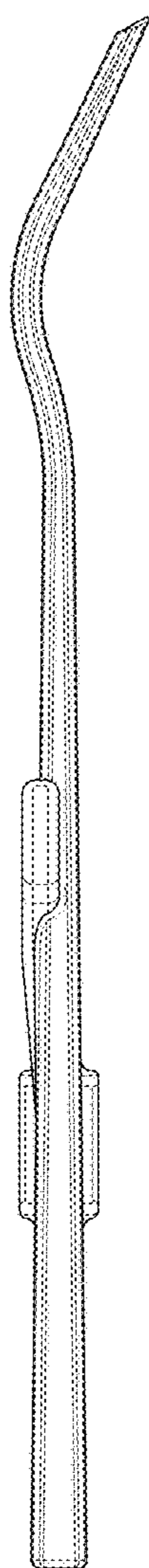

FIG. 7

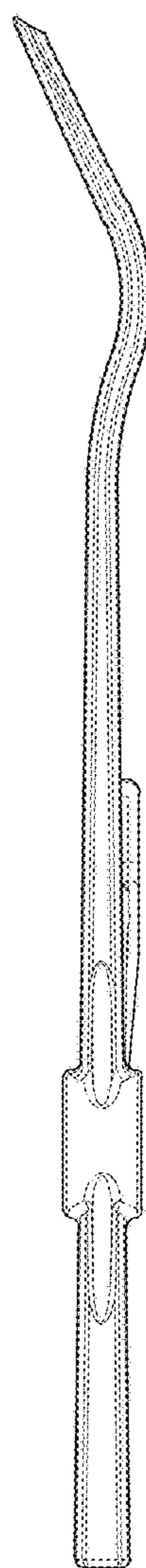

FIG. 8

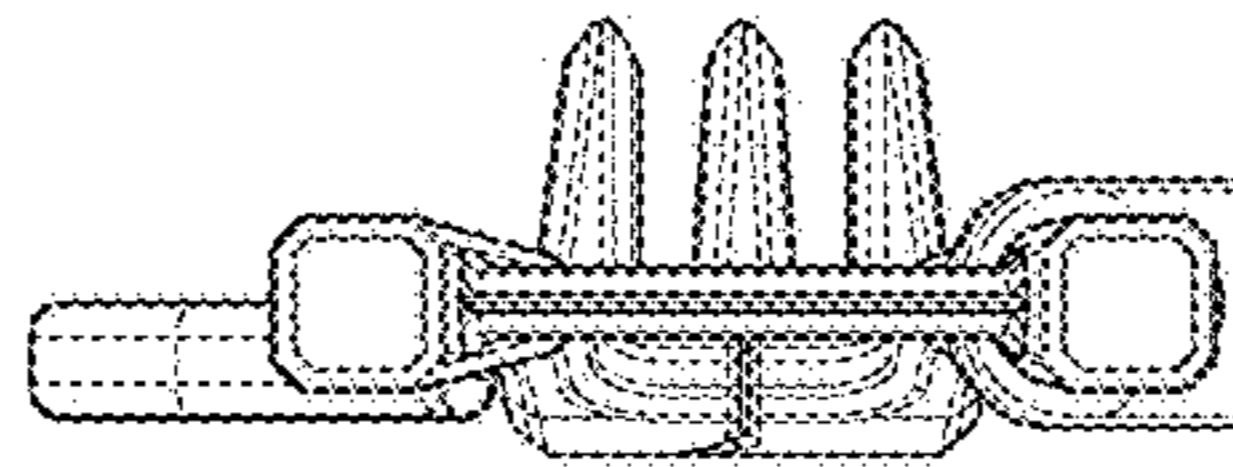

FIG. 9

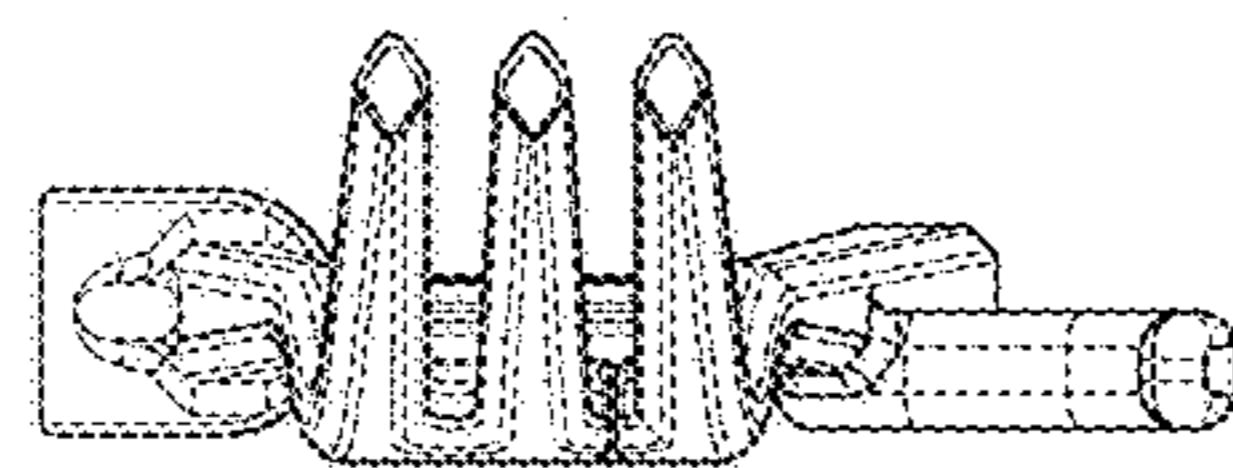

FIG. 10

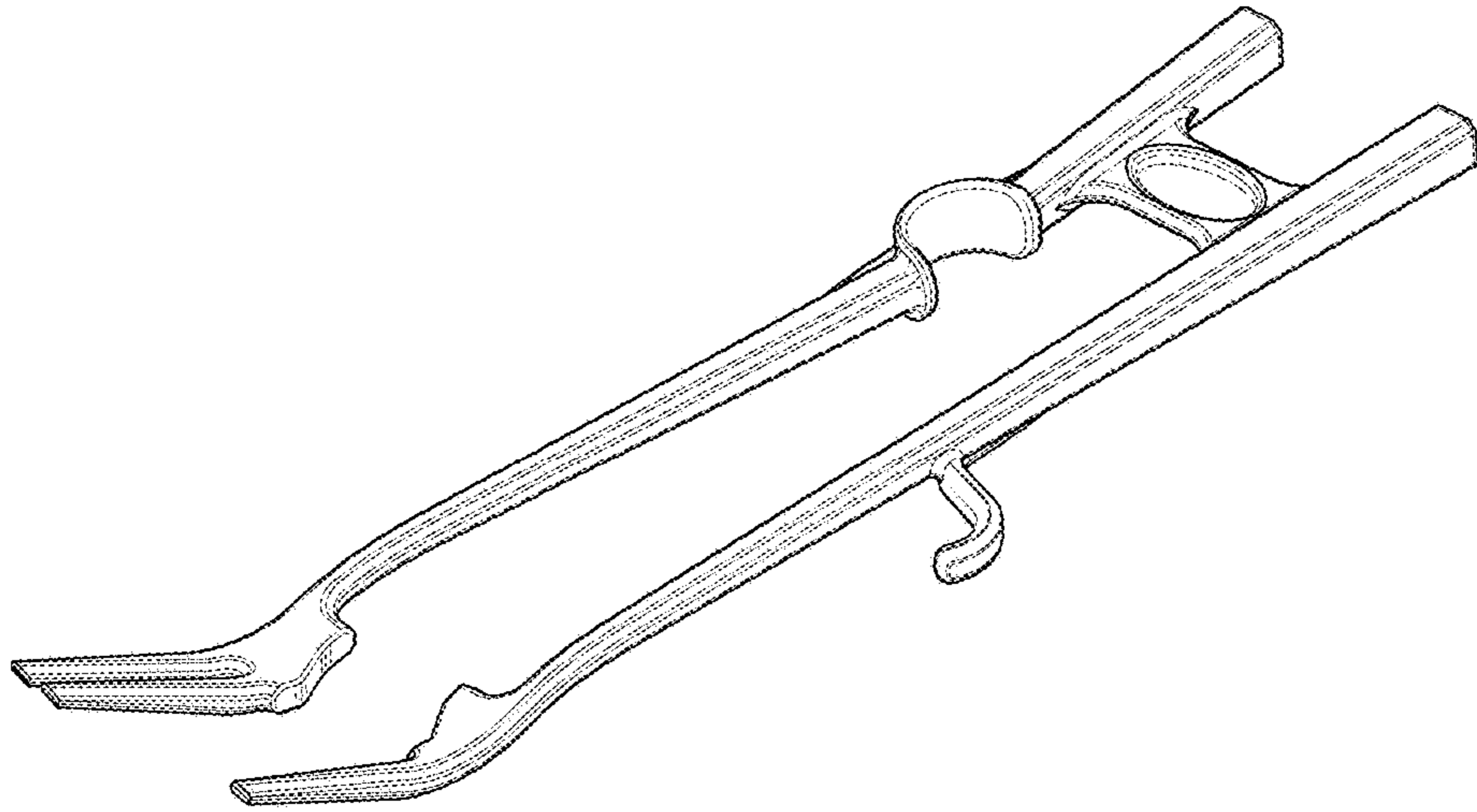

FIG. 11

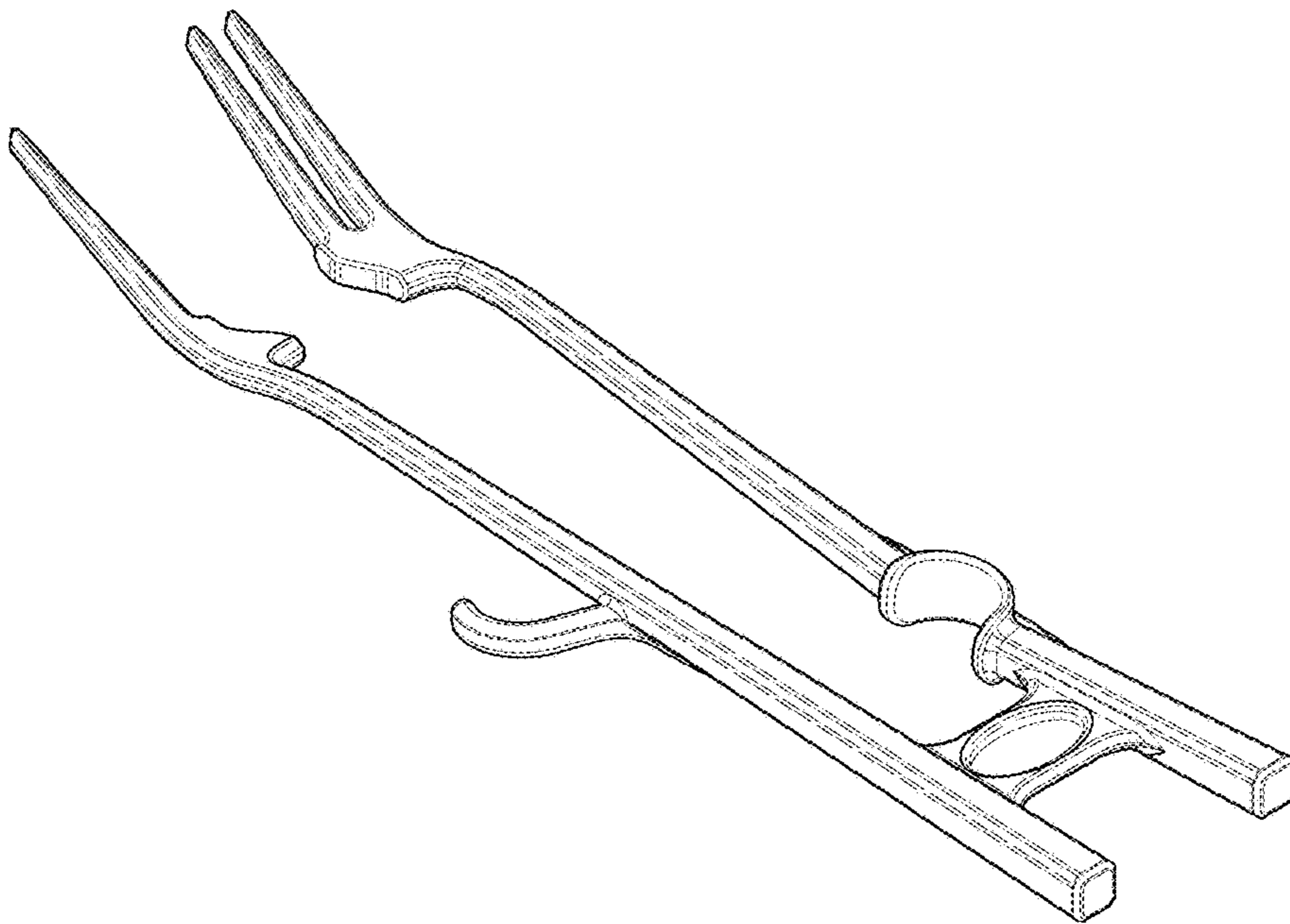

FIG. 12