

US00D844365S

(12) **United States Design Patent** (10) **Patent No.:** **US D844,365 S**
Hu (45) **Date of Patent:** **** Apr. 2, 2019**

(54) **MICROWAVE OVEN**
(71) Applicant: **GUANGDONG MIDEA KITCHEN APPLIANCES MANUFACTURING CO., LTD.**, Foshan, Guangdong (CN)
(72) Inventor: **Yibo Hu**, Guangdong (CN)
(73) Assignee: **GUANGDONG MIDEA KITCHEN APPLIANCES MANUFACTURING CO., LTD.**, Foshan, Guangdong (CN)
(**) Term: **15 Years**

D576,835 S * 9/2008 Shin D7/351
D615,803 S * 5/2010 Sindeaux D7/351
D635,391 S * 4/2011 Sakai D7/350.1
D639,105 S * 6/2011 Shin D7/351
D657,607 S * 4/2012 Ohmae D7/351
D665,219 S * 8/2012 Ohmae D7/351
D665,220 S * 8/2012 Ohmae D7/351
D705,008 S * 5/2014 Shin D7/405
D707,074 S * 6/2014 Shin D7/351

(21) Appl. No.: **29/573,465**
(22) Filed: **Aug. 5, 2016**

FOREIGN PATENT DOCUMENTS

CN 302140879 * 10/2012
CN 302434312 * 5/2013
RU 00096272 * 12/2015

(30) **Foreign Application Priority Data**

Apr. 27, 2016 (CN) 2016 3 0147312

OTHER PUBLICATIONS

Amazon. <URL: https://www.amazon.com/dp/B01D5UC036/ref=psdc_3741631_t2_B00NXRHIO8> Mar. 19, 2016. Samsung Countertop Microwave Oven.*

(Continued)

(51) **LOC (11) Cl.** **07-02**
(52) **U.S. Cl.**
USPC **D7/351**
(58) **Field of Classification Search**
USPC D7/323, 339, 340, 341, 347, 348, 349, D7/351, 350.1, 350.2, 350.3, 350.4, 402, D7/403, 405
CPC .. A21B 2/00; A21B 3/02; F24C 15/02; H05B 1/0263; H05B 2206/044; H05B 6/763; H05B 6/76; H05B 6/802; H05B 6/808; H05B 6/64
See application file for complete search history.

Primary Examiner — Thomas Johannes
Assistant Examiner — Lauren D McVey
(74) *Attorney, Agent, or Firm* — Houtteman Law LLC

(57) **CLAIM**

The ornamental design for a microwave oven, as shown and described.

DESCRIPTION

FIG. 1 is a front elevation view of a microwave oven showing my new design;
FIG. 2 is a left side elevation view thereof;
FIG. 3 is a right side elevation view thereof;
FIG. 4 is a top plan view thereof; and,
FIG. 5 is a front perspective view thereof.
Broken lines form no part of the claimed design.

1 Claim, 5 Drawing Sheets

(56) **References Cited**
U.S. PATENT DOCUMENTS

D329,164 S * 9/1992 Edman D7/351
D437,179 S * 2/2001 Ozaki D7/351
D522,800 S * 6/2006 Lee D7/351
D561,529 S * 2/2008 Suh D7/351

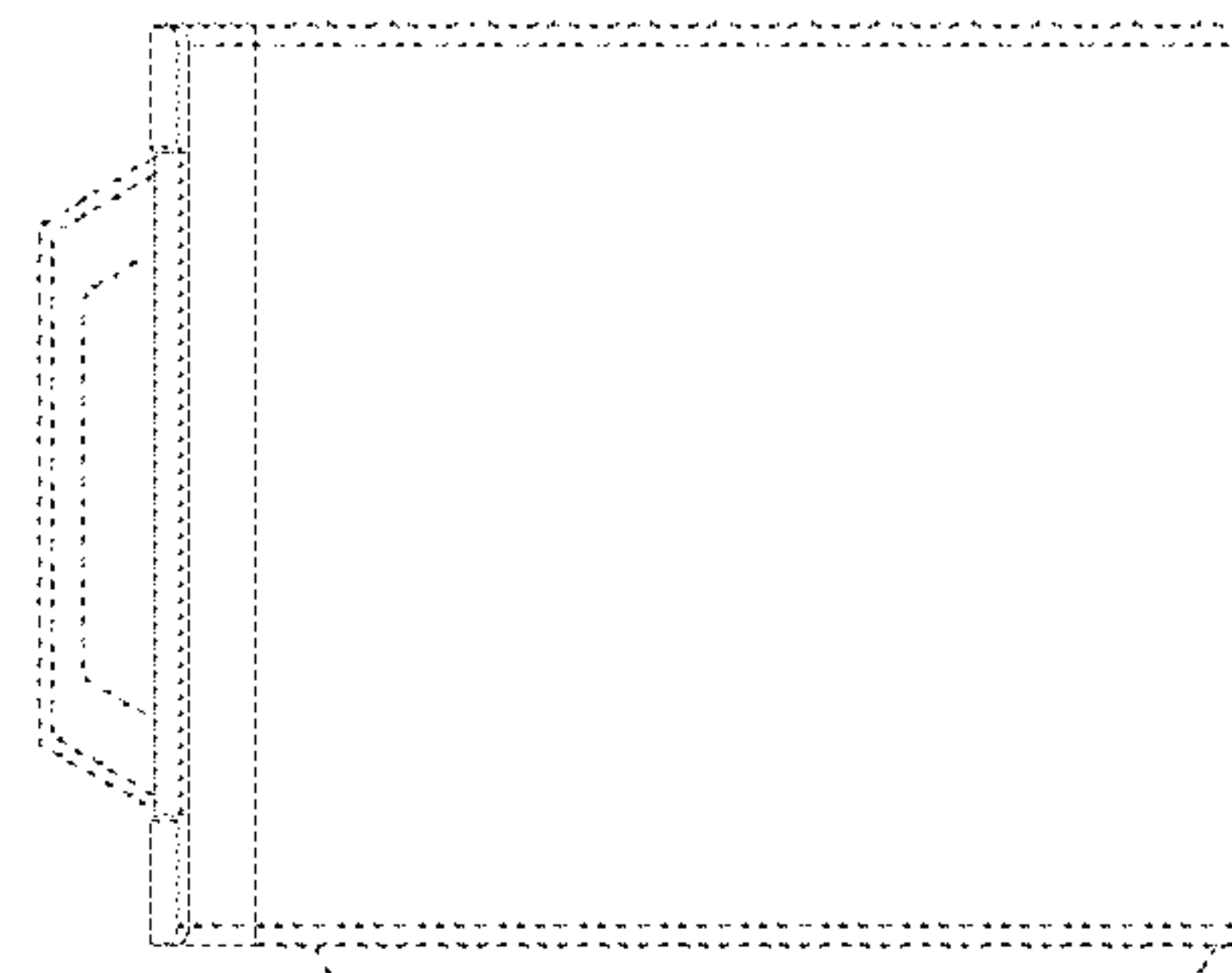
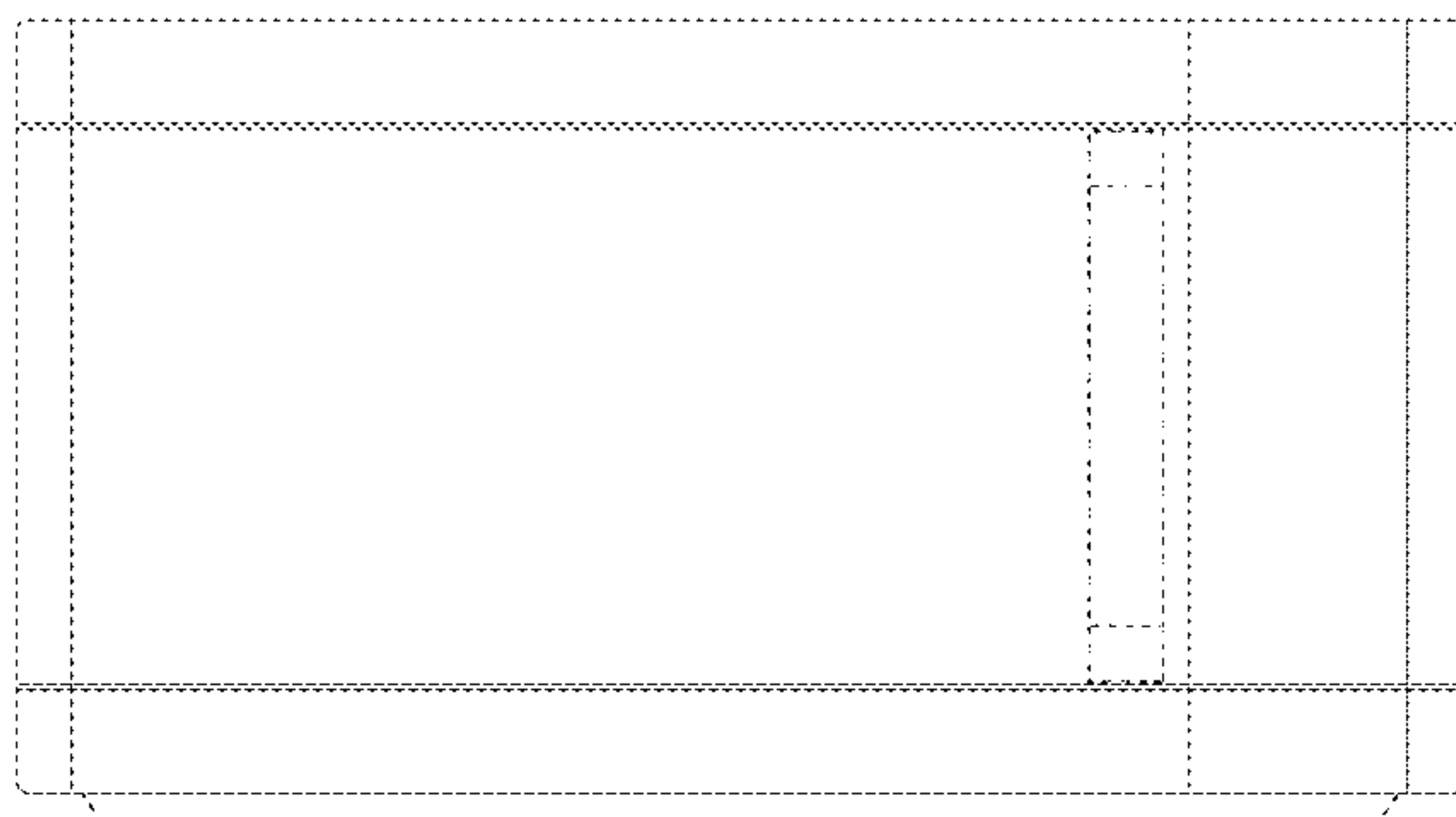

(56)

References Cited

OTHER PUBLICATIONS

Amazon. <URL: https://www.amazon.com/Samsung-MG11H2020CT-Countertop-Microwave-Interior/dp/B00NXXRHIO8/ref=sr_1_fkmr0_3?ie=UTF8&qid=1524596198&E2%80%A6.> Sep. 26, 2014. Samsung Countertop Microwave Oven.*

Amazon. <URL: https://www.amazon.com/dp/B075319V1W/ref=sspa_dk_detail_4?psc=1&pd_rd_i=B075319V1W&pd_rd_wg=tW4Pb&pd_rd_r=FKVJ8PAMBE0ZPE4R%E2%80%A6.> Aug. 23, 2017. Big Chill Retro Microwave Oven.*

* cited by examiner

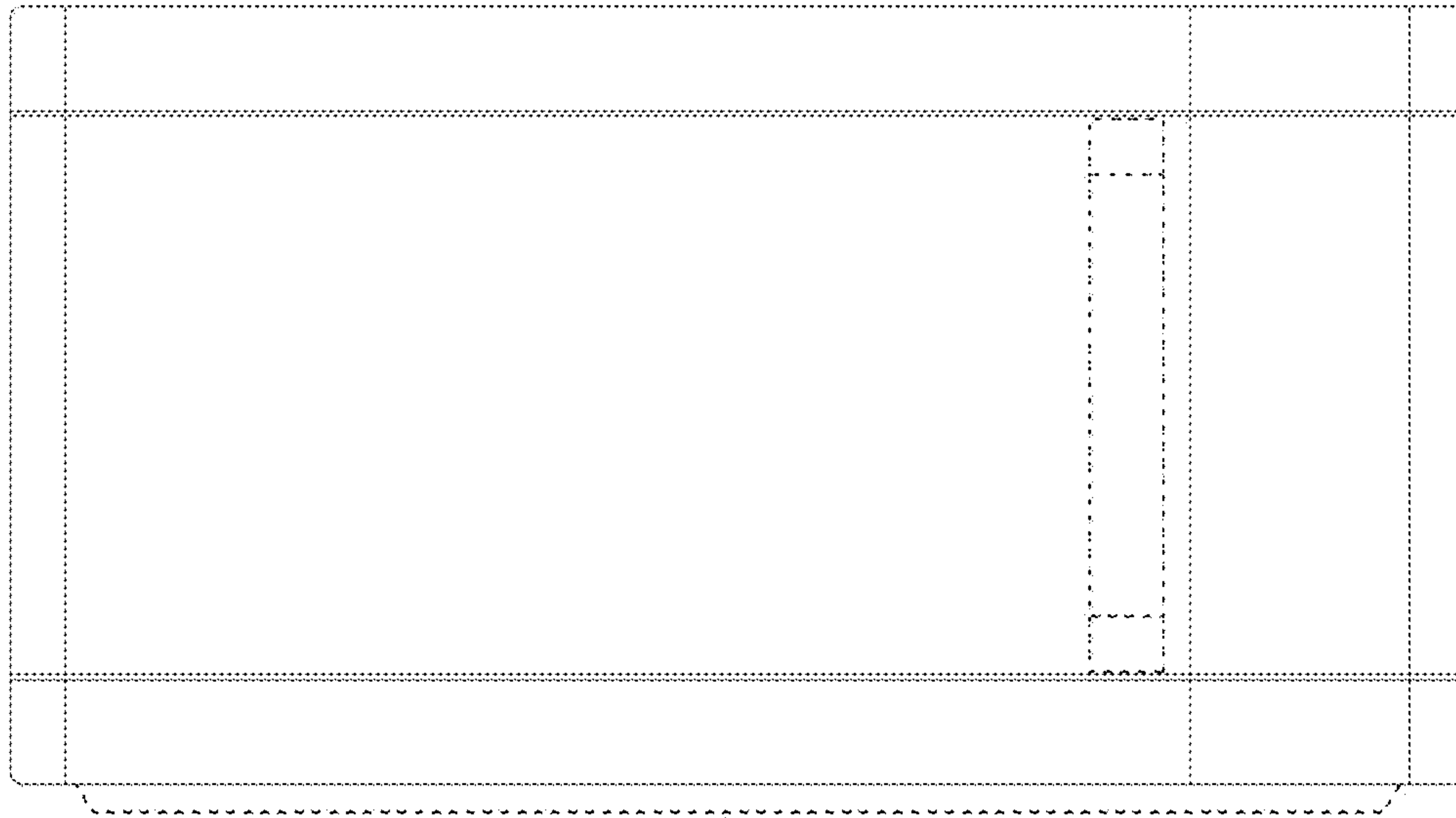

FIG. 1

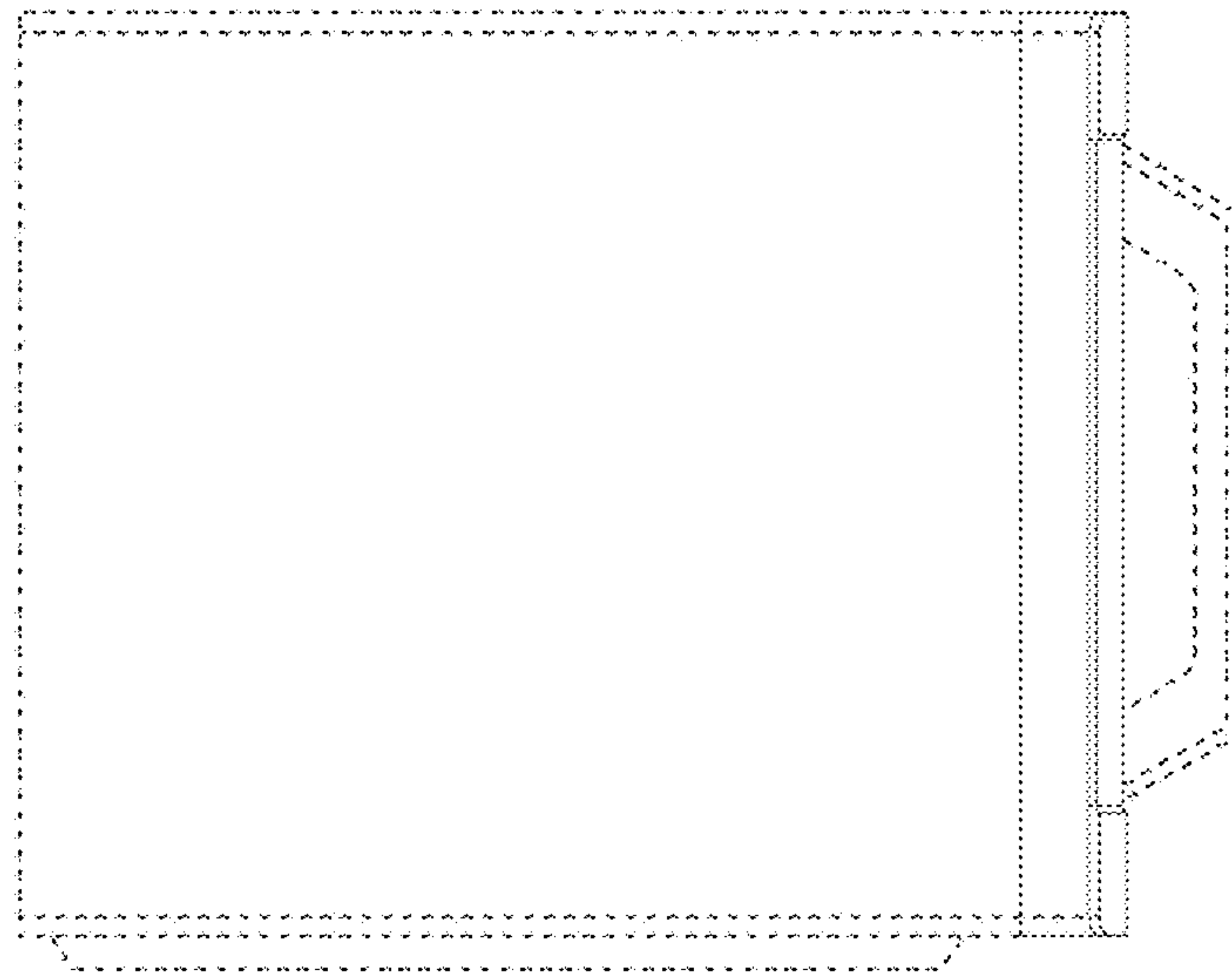

FIG. 2

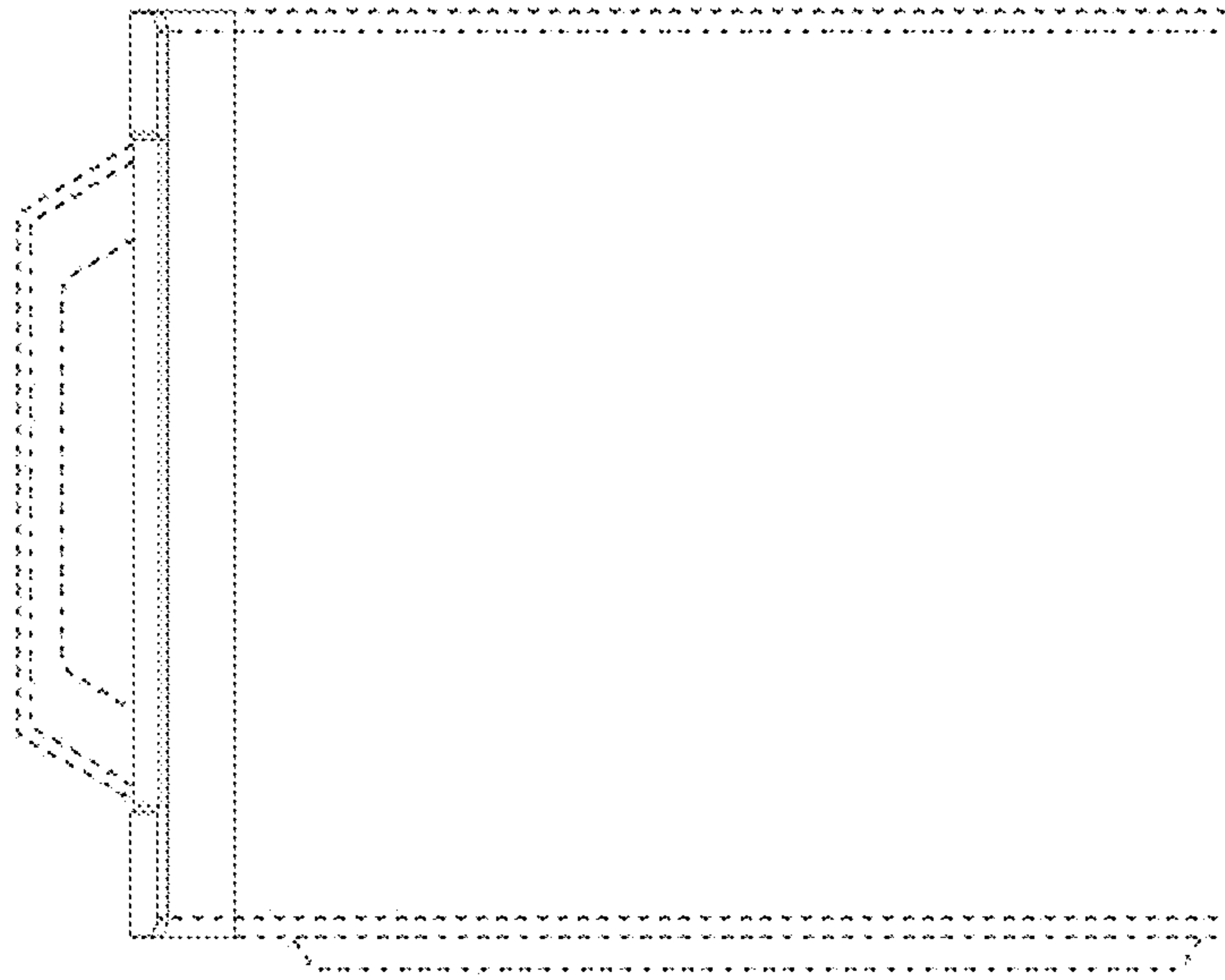

FIG. 3

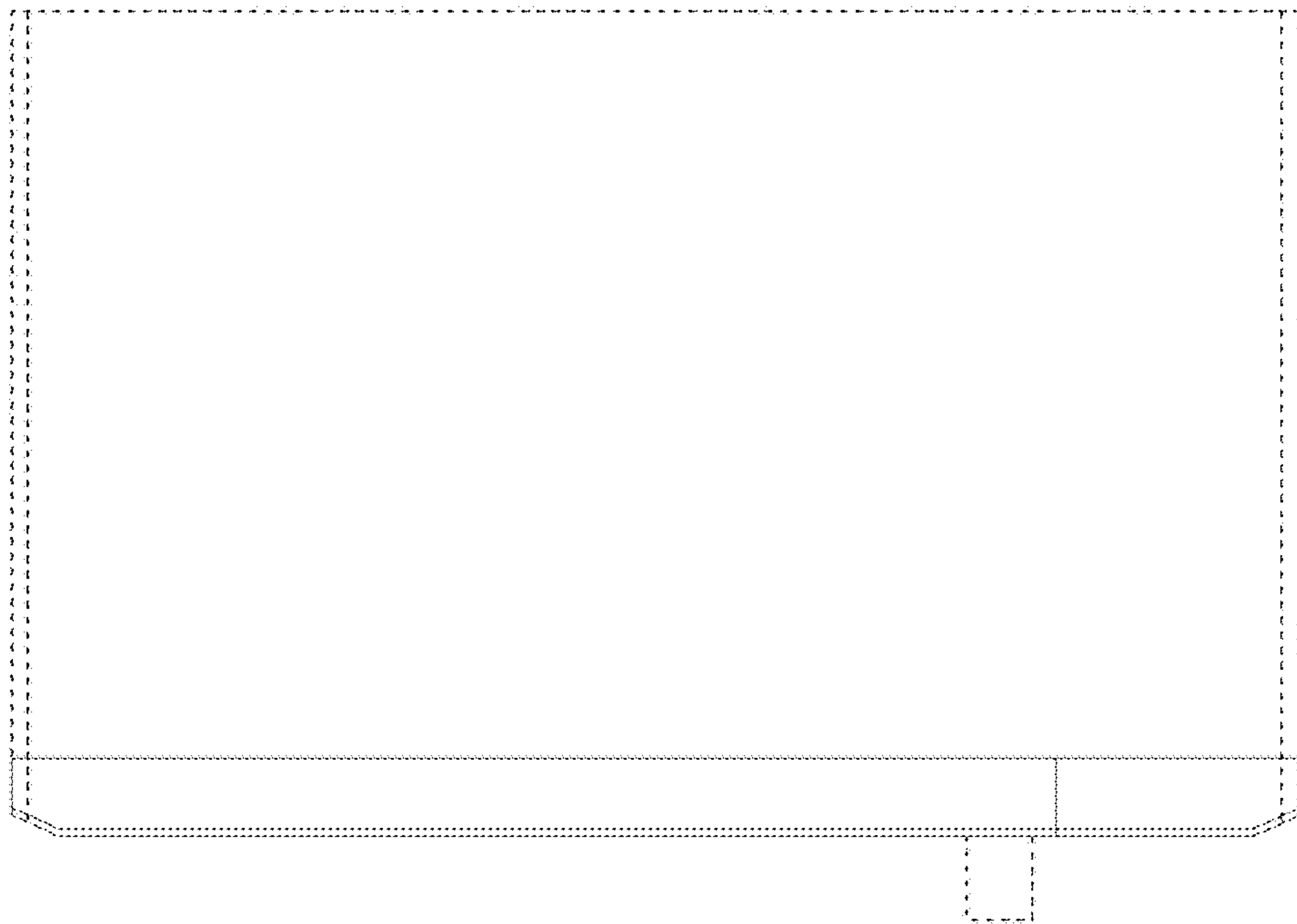

FIG. 4

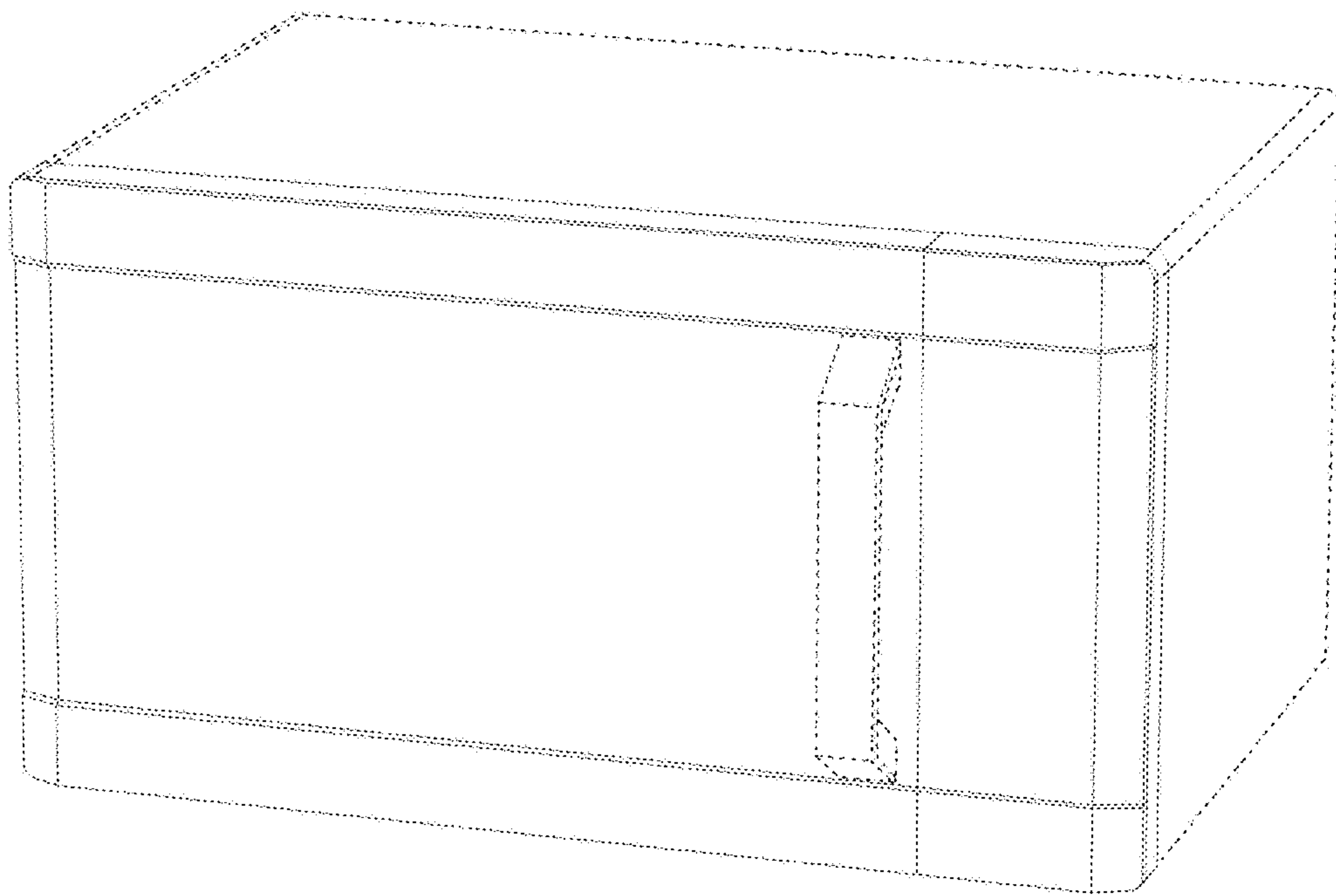

FIG. 5