

US00D844123S

(12) **United States Design Patent**
Schumann

(10) **Patent No.:** **US D844,123 S**

(45) **Date of Patent:** **** Mar. 26, 2019**

- (54) **WATER HEATER**
- (71) Applicant: **Stiebel Eltron GmbH & Co. KG**,
Holzminden (DE)
- (72) Inventor: **Dirk Schumann**, Munster (DE)
- (73) Assignee: **Stiebel Eltron GmbH & Co. KG**,
Holzminden (DE)
- (**) Term: **15 Years**
- (21) Appl. No.: **29/640,100**
- (22) Filed: **Mar. 12, 2018**
- (51) **LOC (11) Cl.** **23-03**
- (52) **U.S. Cl.**
USPC **D23/318**
- (58) **Field of Classification Search**
USPC D23/318, 319, 320, 321, 322, 314, 317,
D23/329, 330, 342; D13/184
CPC F24H 9/06; F24H 9/2035; F24H 1/125;
F24H 1/145; F24H 1/186; F24H 9/124;
F24H 9/2078; F24H 9/2007; F24H 1/08;
F24H 1/10; F24H 1/12; F24H 1/18; F24H
1/22; F24H 1/50; F24H 1/182
See application file for complete search history.

- 7,055,465 B1 * 6/2006 Huang F24H 9/2035
122/4 D
- D531,290 S * 10/2006 Baumgartner D23/319
- D683,001 S * 5/2013 Lee D23/320
- D696,185 S * 12/2013 Azuma D13/101
- D703,158 S * 4/2014 Parsons D13/177
- 9,574,792 B2 * 2/2017 Lutz, II F24H 1/102
- D831,804 S * 10/2018 Fritz D23/318
- 2017/0248343 A1 * 8/2017 Hou F24H 1/182

* cited by examiner

Primary Examiner — T Chase Nelson

Assistant Examiner — Ania Aman

(74) *Attorney, Agent, or Firm* — Abelman, Frayne & Schwab

(57) **CLAIM**

The ornamental design for a water heater, as shown and described.

DESCRIPTION

FIG. 1 is a bottom, front, right side perspective view of a water heater showing my new design;
FIG. 2 is a front elevational view thereof;
FIG. 3 is a rear elevational view thereof;
FIG. 4 is a left side elevational view thereof;
FIG. 5 is a right side elevational view thereof;
FIG. 6 is a top plan view thereof; and,
FIG. 7 is a bottom view thereof.

1 Claim, 5 Drawing Sheets

(56) **References Cited**

U.S. PATENT DOCUMENTS

- D356,861 S * 3/1995 Busalt D23/318
- 7,046,922 B1 * 5/2006 Sturm F24H 1/102
392/465

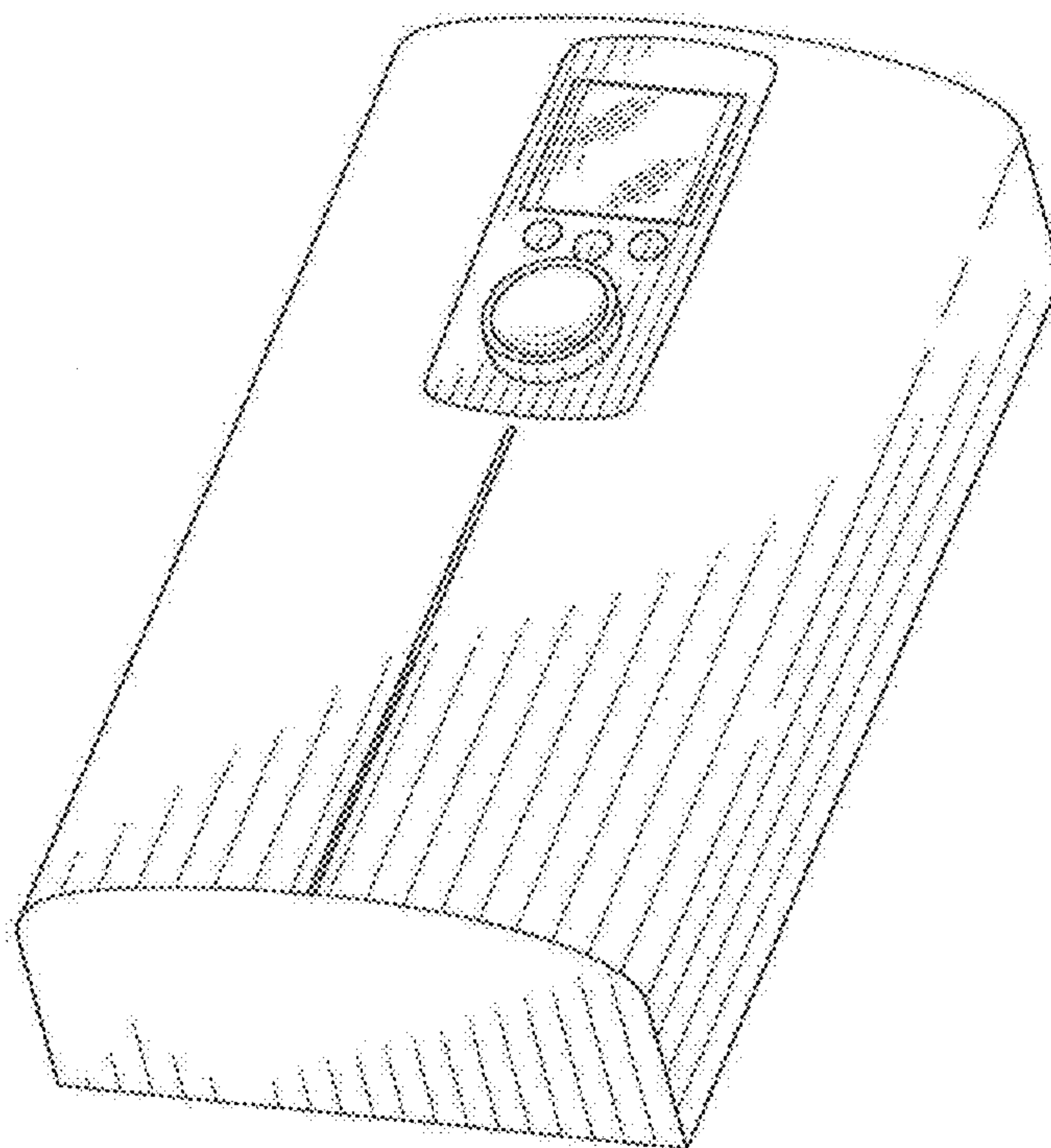

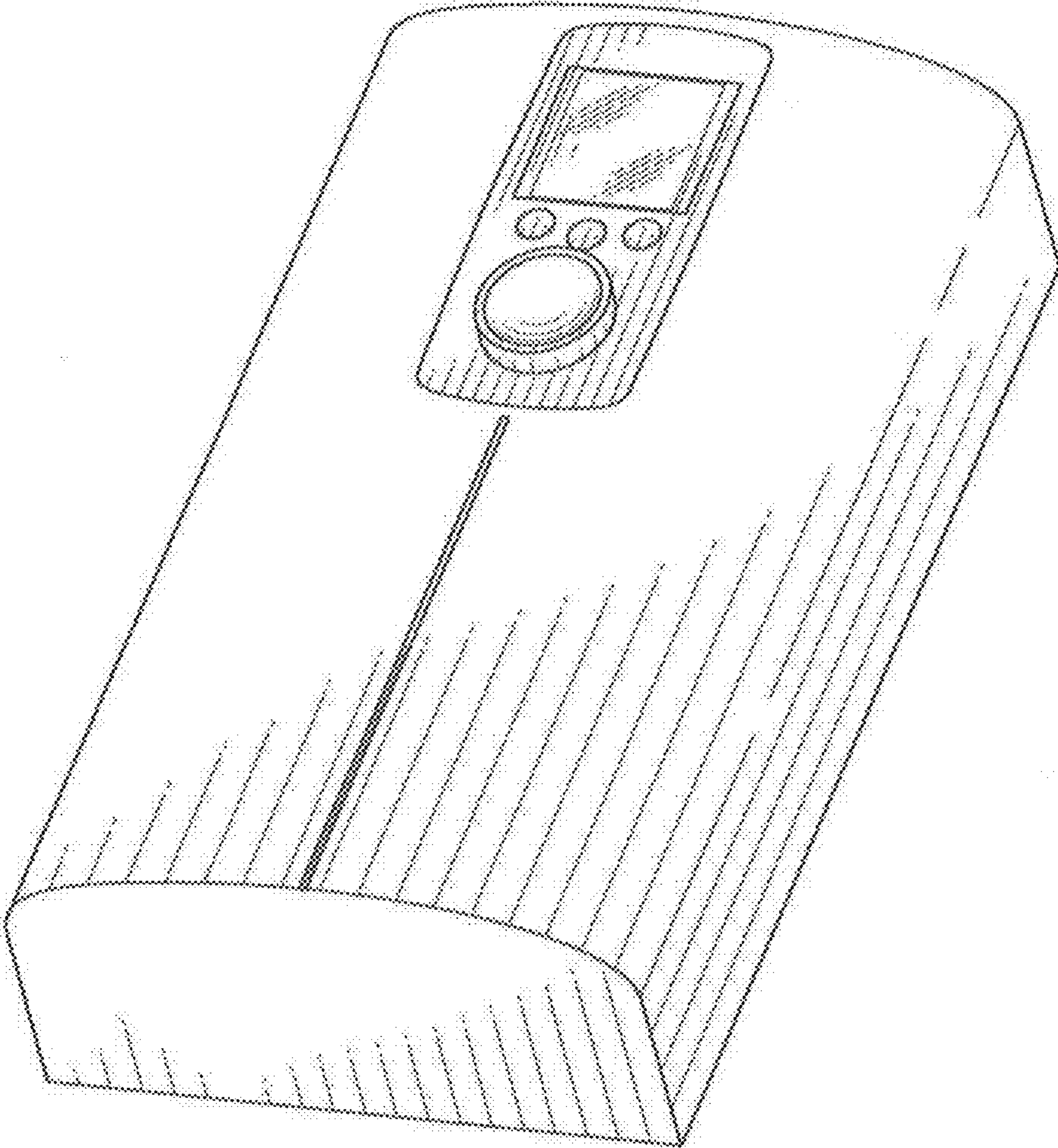

FIG. 1

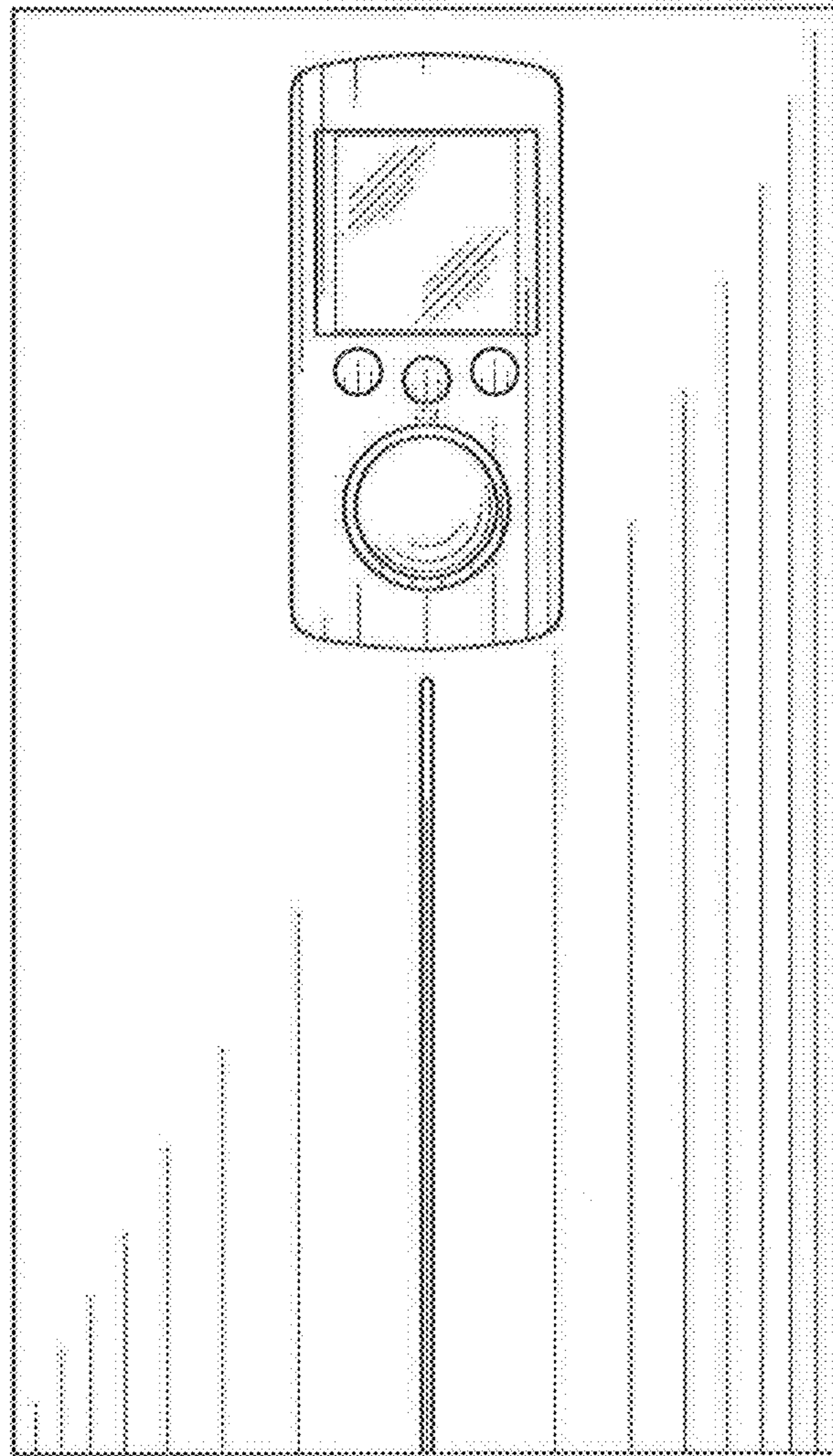

FIG. 2

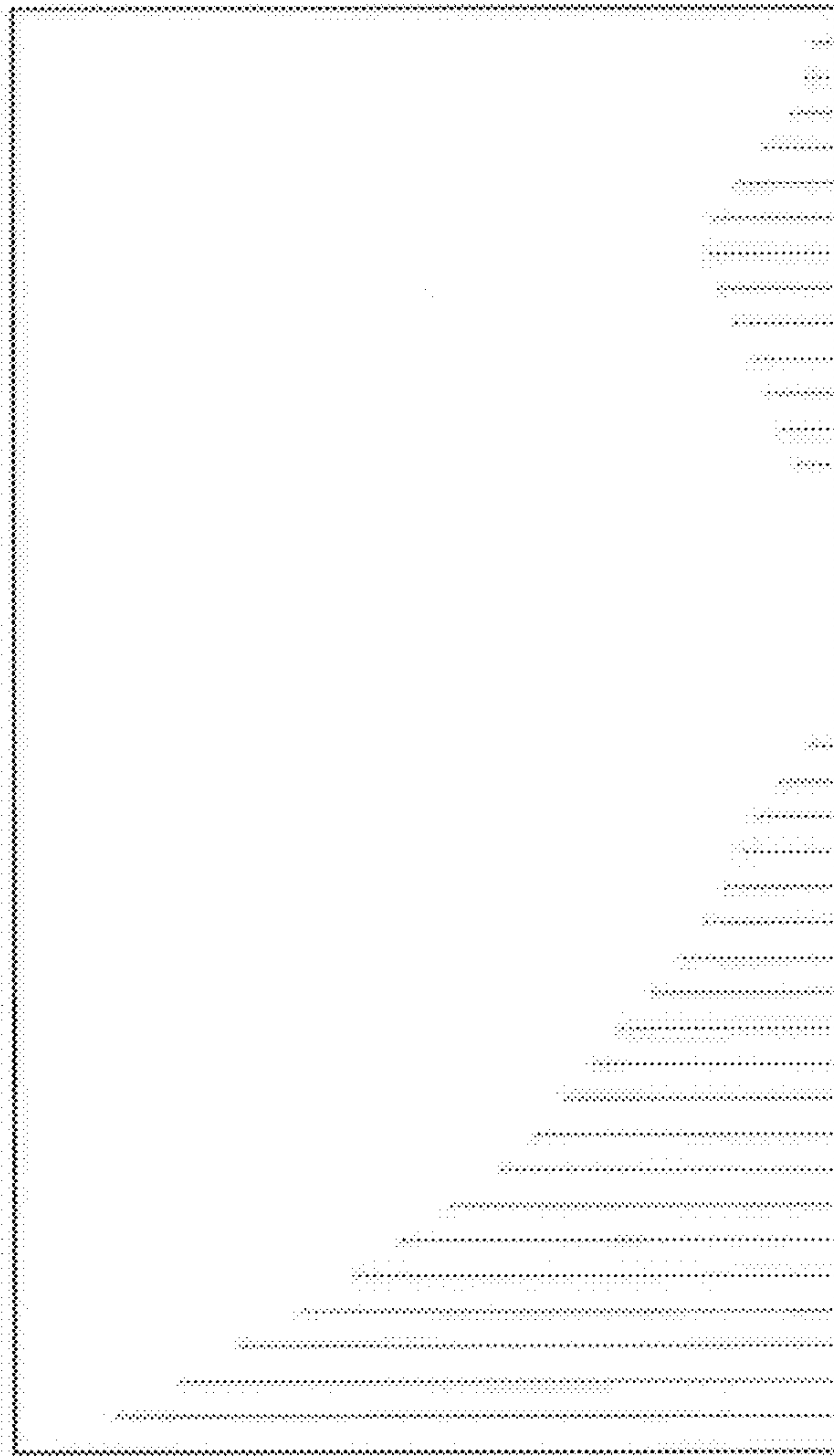

FIG. 3

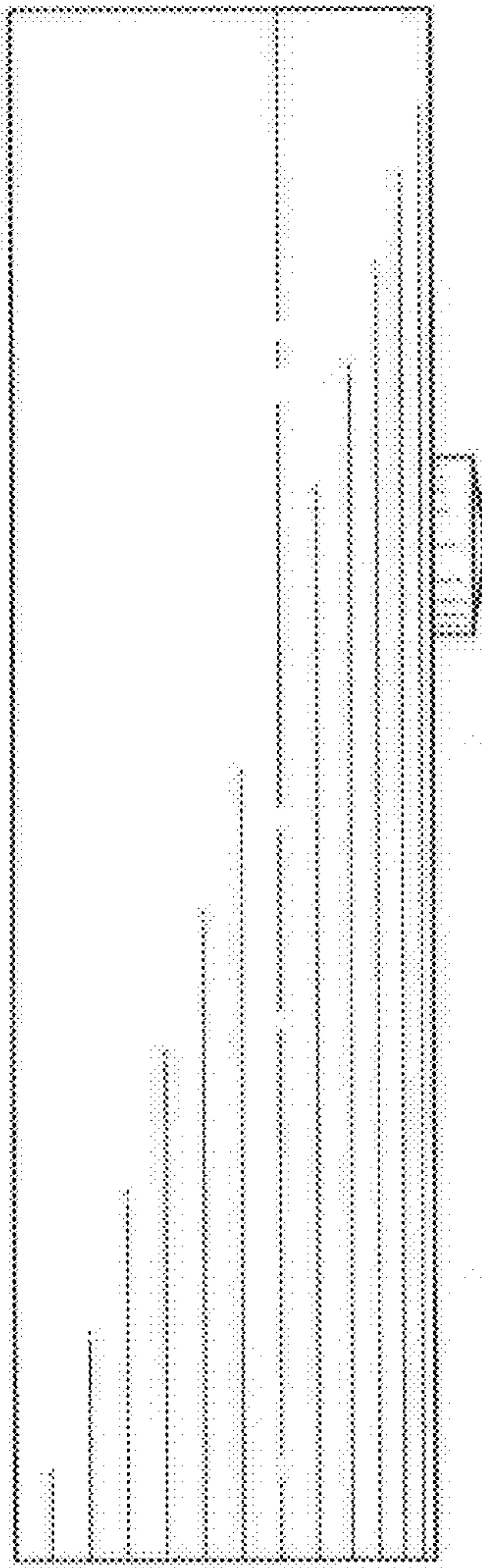

FIG. 4

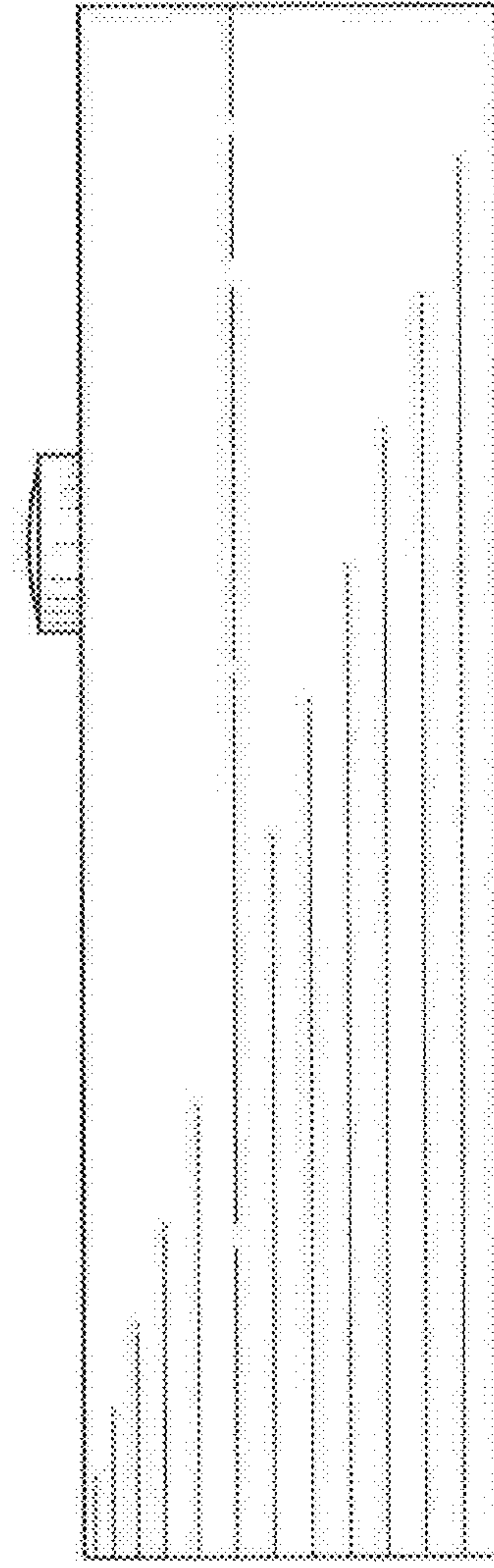

FIG. 5

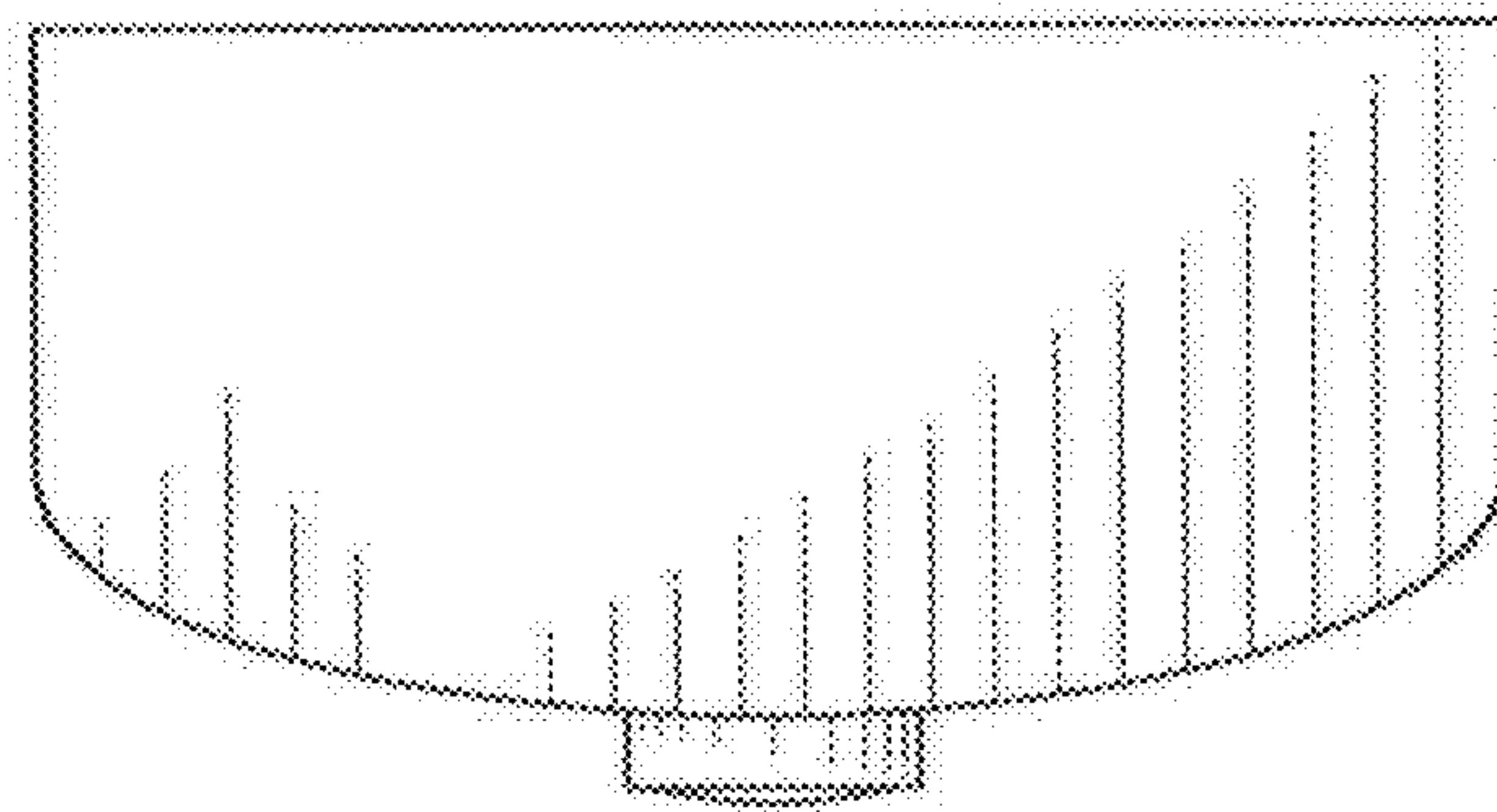

FIG. 6

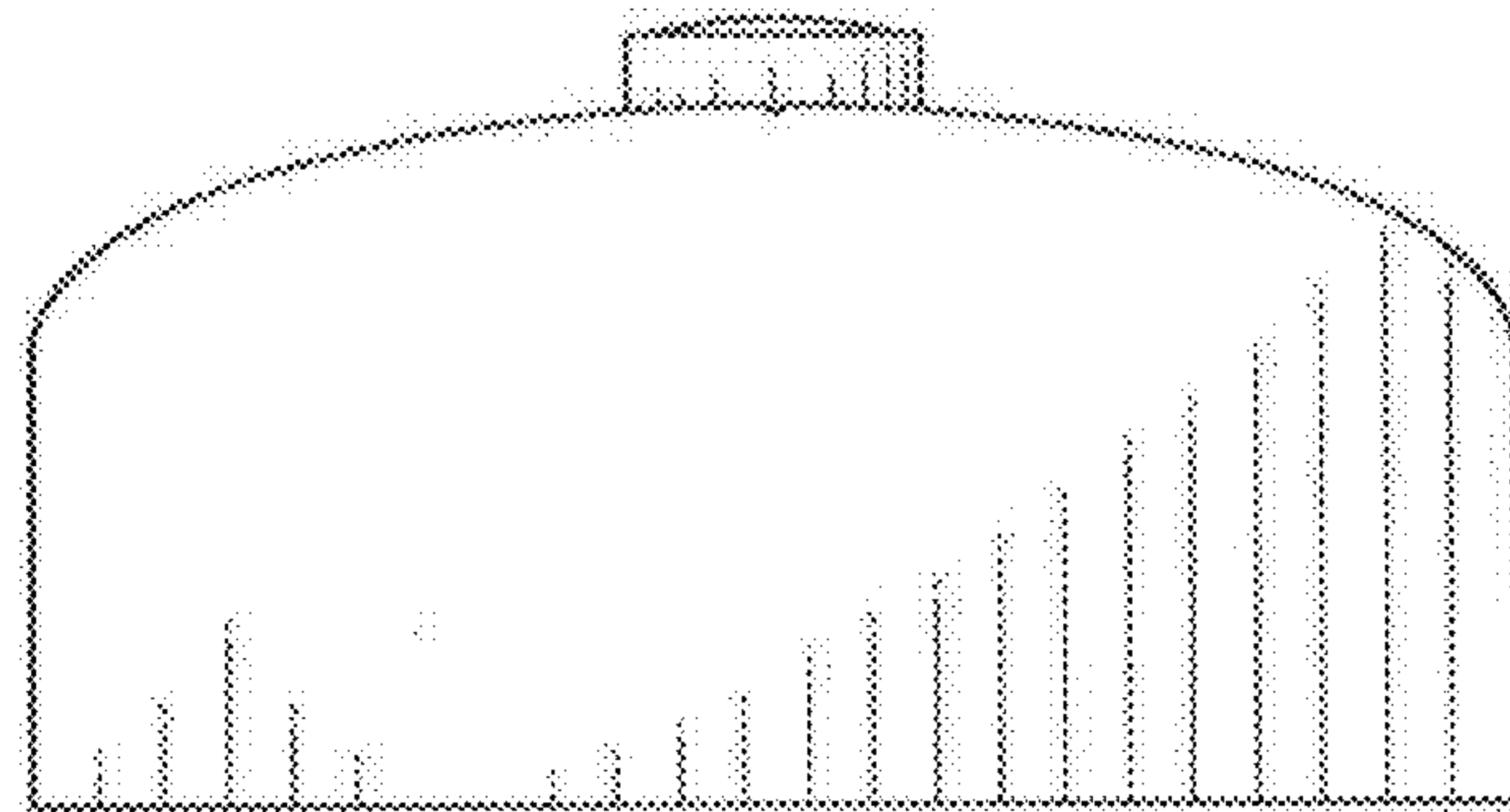

FIG. 7