



US00D844117S

(12) **United States Design Patent**
Kennison

(10) **Patent No.:** **US D844,117 S**

(45) **Date of Patent:** **** Mar. 26, 2019**

(54) **FLUE PLUG**

(71) Applicant: **Bacharach Inc.**, New Kensington, PA (US)

(72) Inventor: **Aaron E. Kennison**, Export, PA (US)

(73) Assignee: **BACHARACH INC.**, New Kensington, PA (US)

(**) Term: **15 Years**

(21) Appl. No.: **29/590,849**

(22) Filed: **Jan. 13, 2017**

(51) **LOC (11) Cl.** **23-01**

(52) **U.S. Cl.**
USPC **D23/260**

(58) **Field of Classification Search**
USPC D23/260, 259, 261-262, 403, 421;
D13/133, 156; D8/397; D9/439, 454;
4/287-295
CPC F16L 5/02; F16L 5/04; F16L 5/08; F16L
5/10
See application file for complete search history.

(56) **References Cited**

U.S. PATENT DOCUMENTS

- 3,821,969 A * 7/1974 Sinko B65D 59/02
138/89
- D362,048 S * 9/1995 Lang D23/262
- D372,960 S * 8/1996 Allmon D23/260

- D420,589 S * 2/2000 Baxter D9/439
- D421,792 S * 3/2000 Bevacco D23/260
- D583,912 S * 12/2008 Beele F16L 5/04
D23/260
- D639,657 S * 6/2011 Hoyt D9/439
- D664,632 S * 7/2012 Moe D23/260
- D686,496 S * 7/2013 Strauli D9/434
- D749,199 S * 2/2016 von Lepel D23/260
- D762,825 S * 8/2016 Walker D23/259
- D787,025 S * 5/2017 Taylor D23/260

* cited by examiner

Primary Examiner — Eric L Goodman

Assistant Examiner — Amy C Wierenga

(74) *Attorney, Agent, or Firm* — Fay Sharpe LLP

(57) **CLAIM**

The ornamental design for a flue plug, as shown and described.

DESCRIPTION

FIG. 1 is a top perspective view of a flue plug according to my new design;
 FIG. 2 is a bottom perspective view thereof;
 FIG. 3 is a top plan view thereof;
 FIG. 4 is a bottom plan view thereof;
 FIG. 5 is the front elevation view thereof;
 FIG. 6 is a rear elevation view thereof;
 FIG. 7 is a left elevation view thereof; and,
 FIG. 8 is a right elevation view thereof.
 The broken lines in FIGS. 1-8 illustrate portions of the flue plug that form no part of the claimed design.

1 Claim, 8 Drawing Sheets

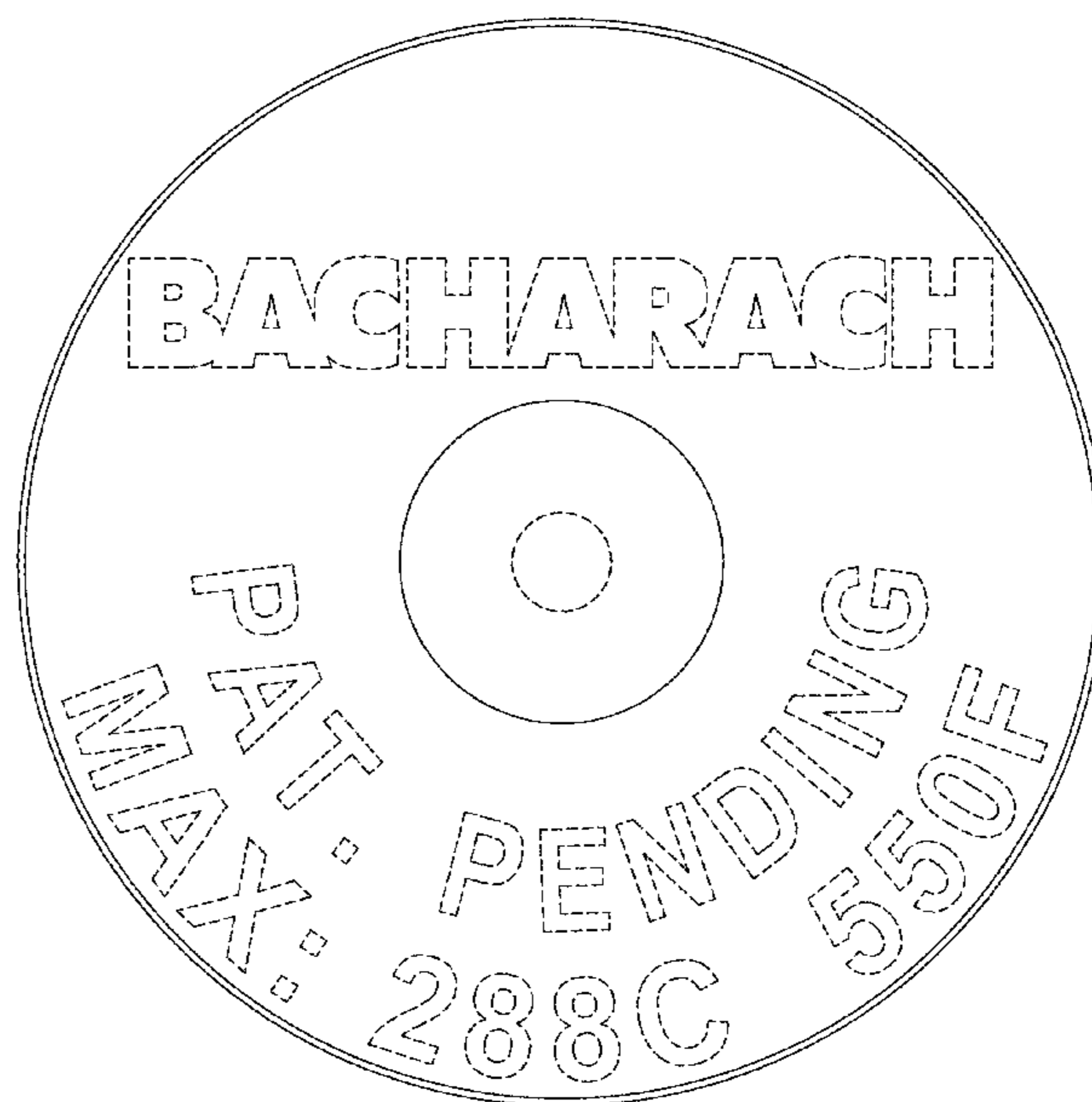
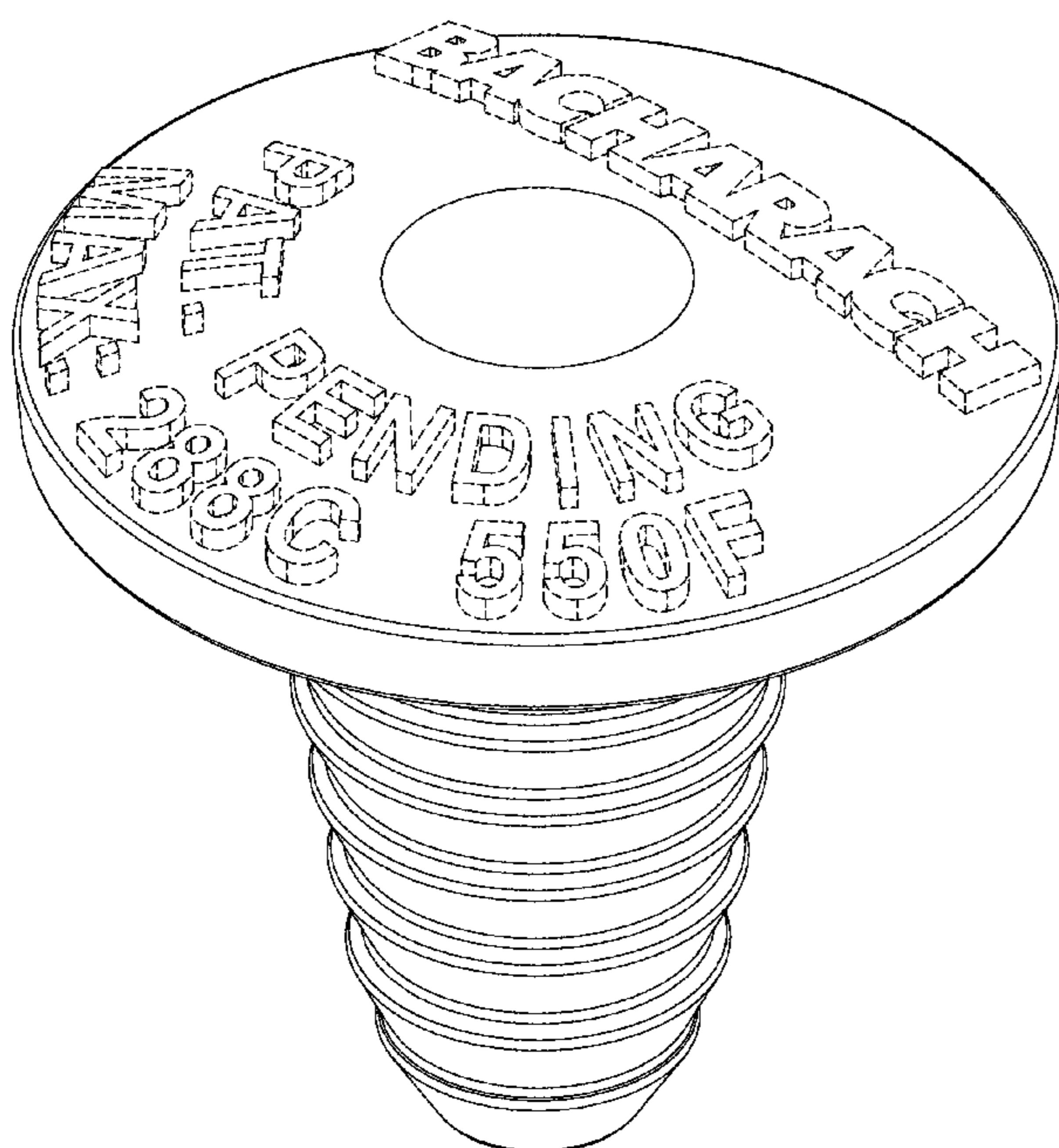

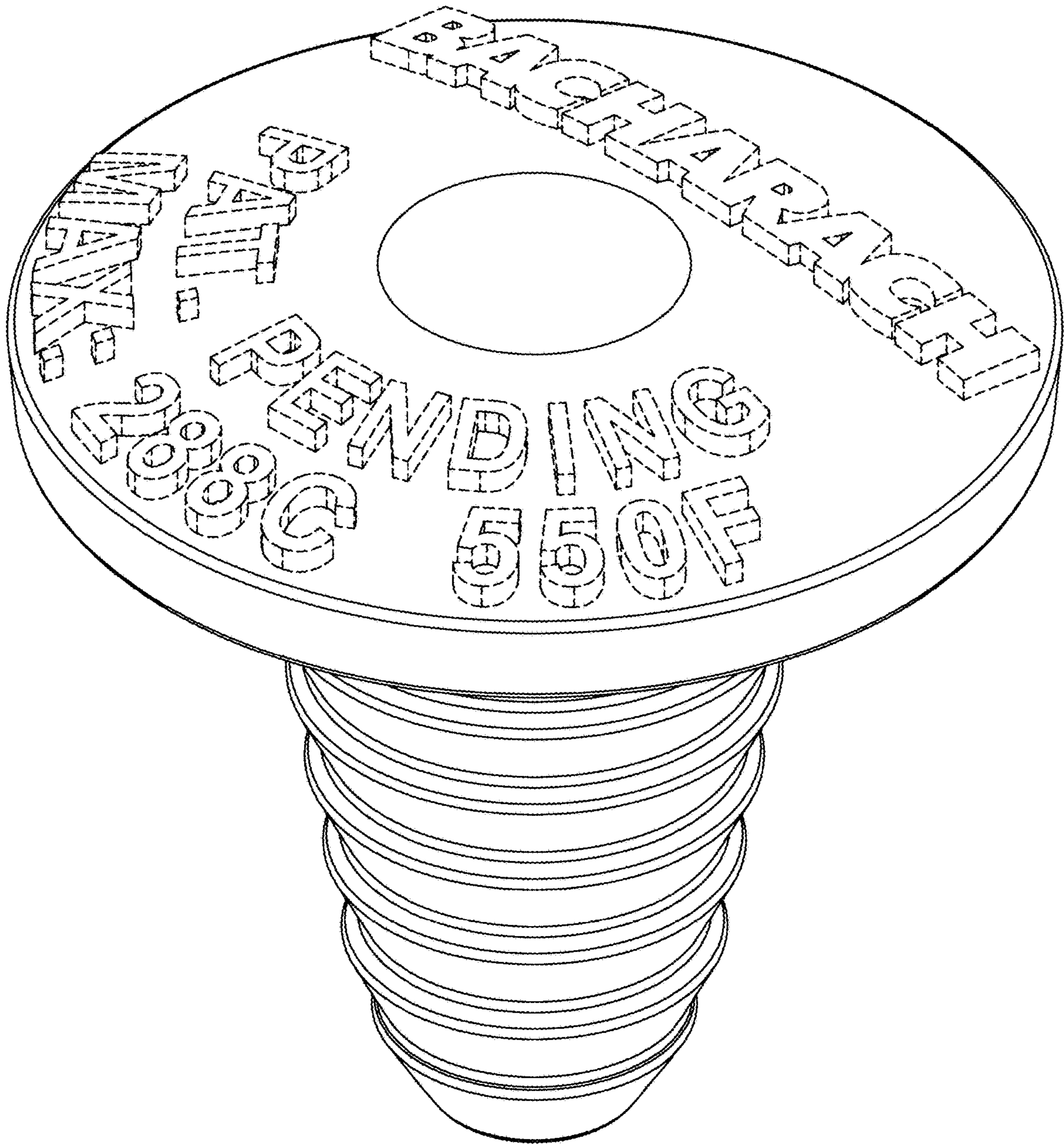

FIG. 1

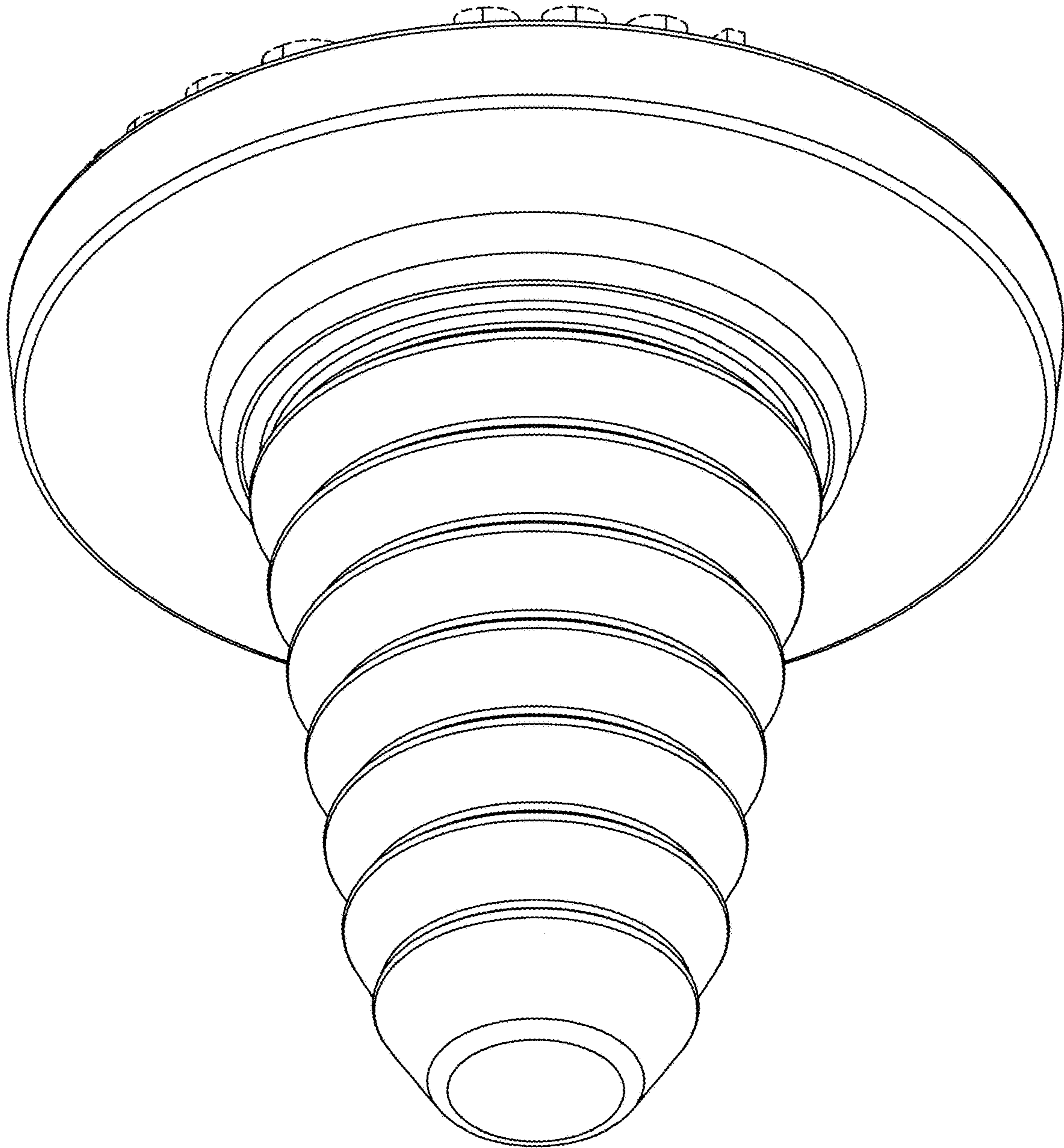

FIG. 2



FIG. 3

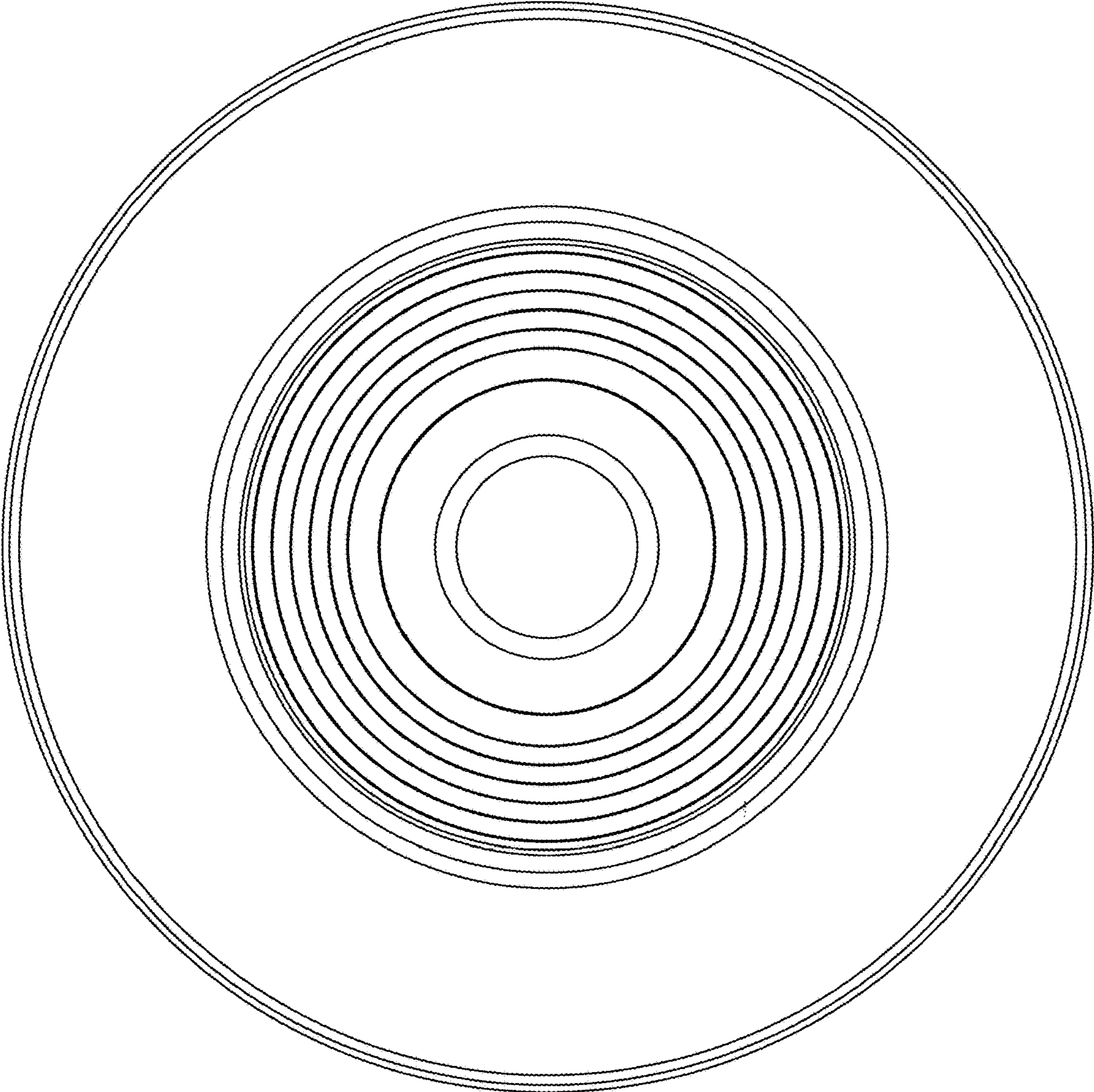

FIG. 4

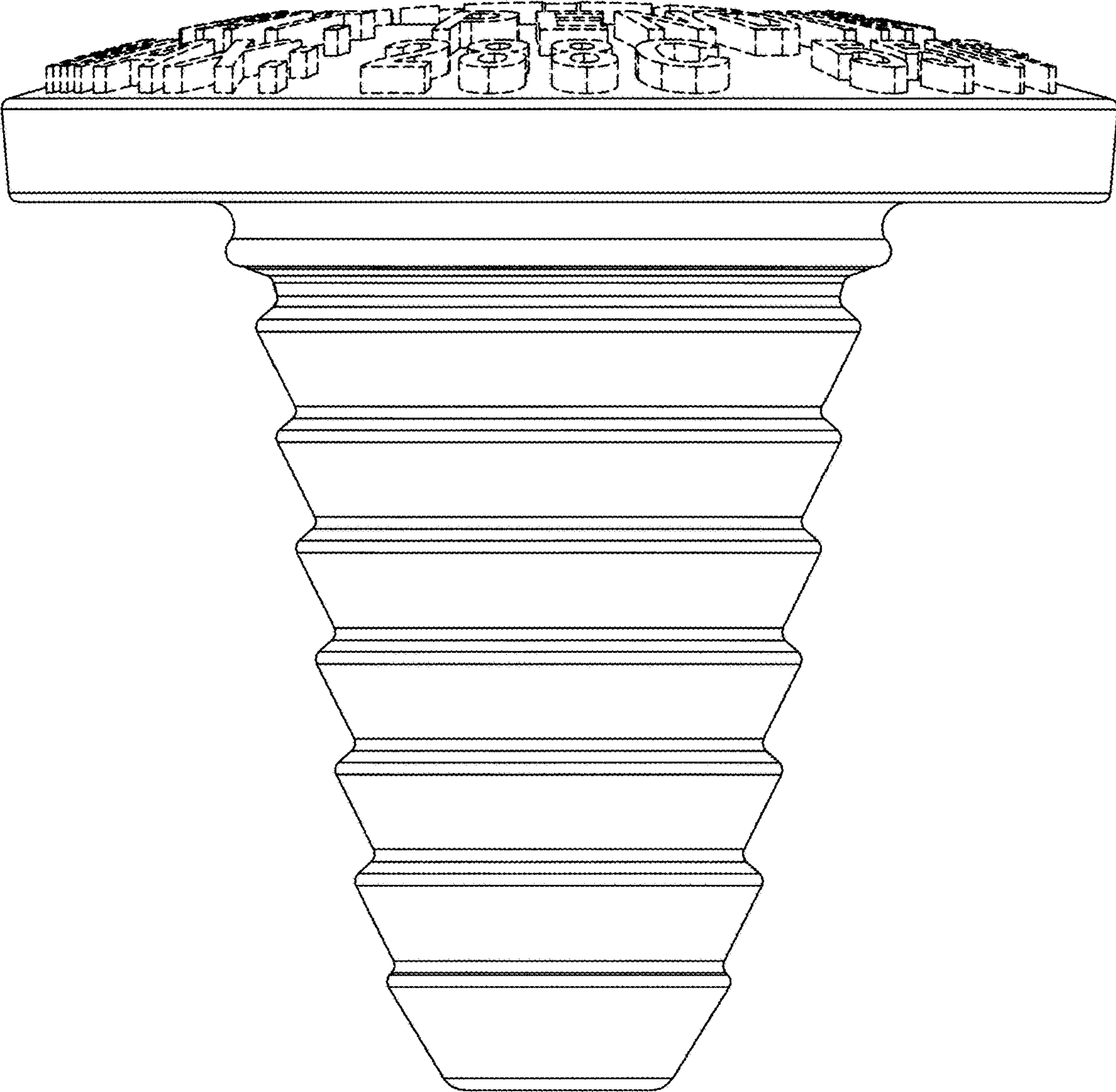

FIG. 5

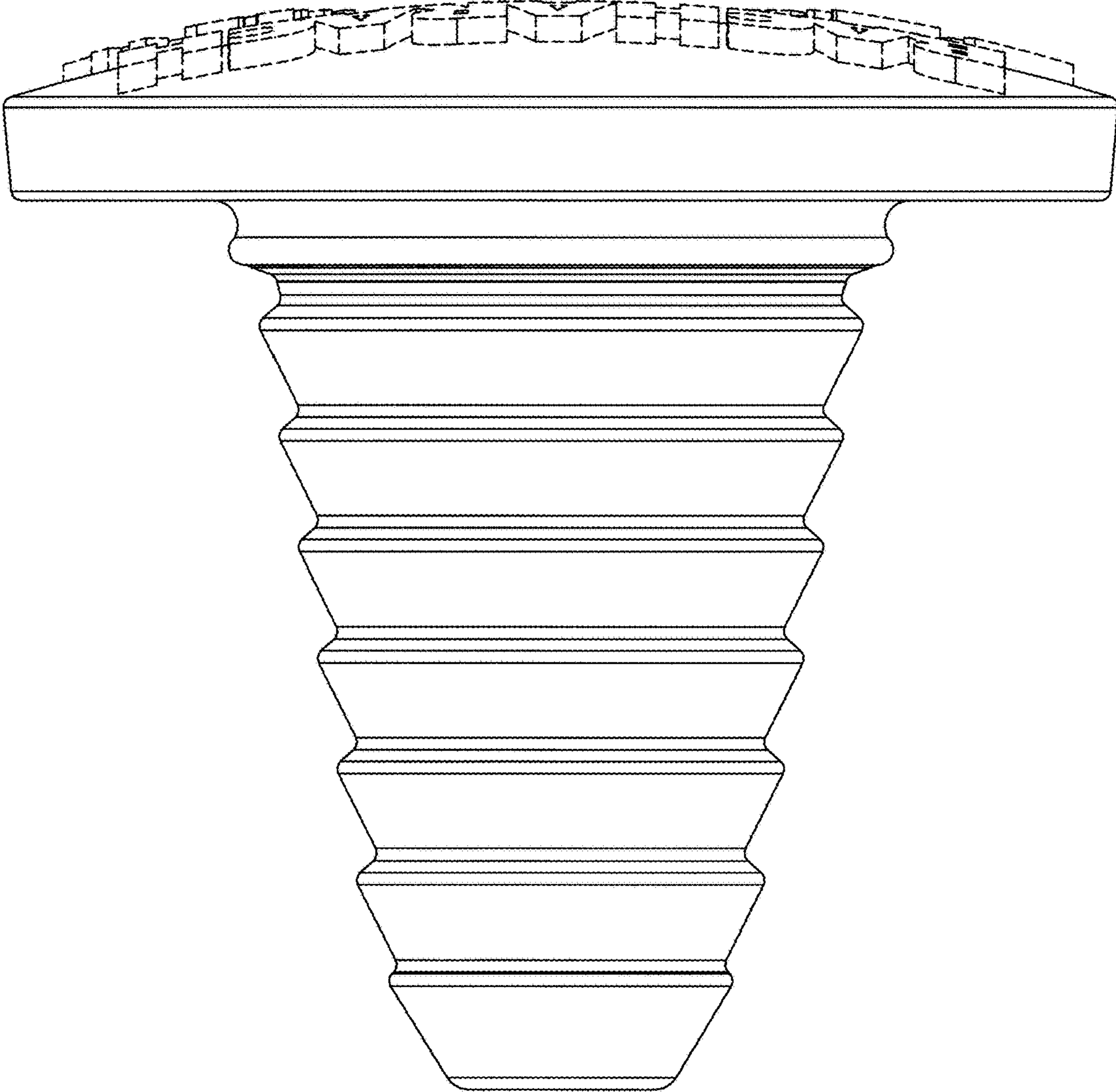

FIG. 6

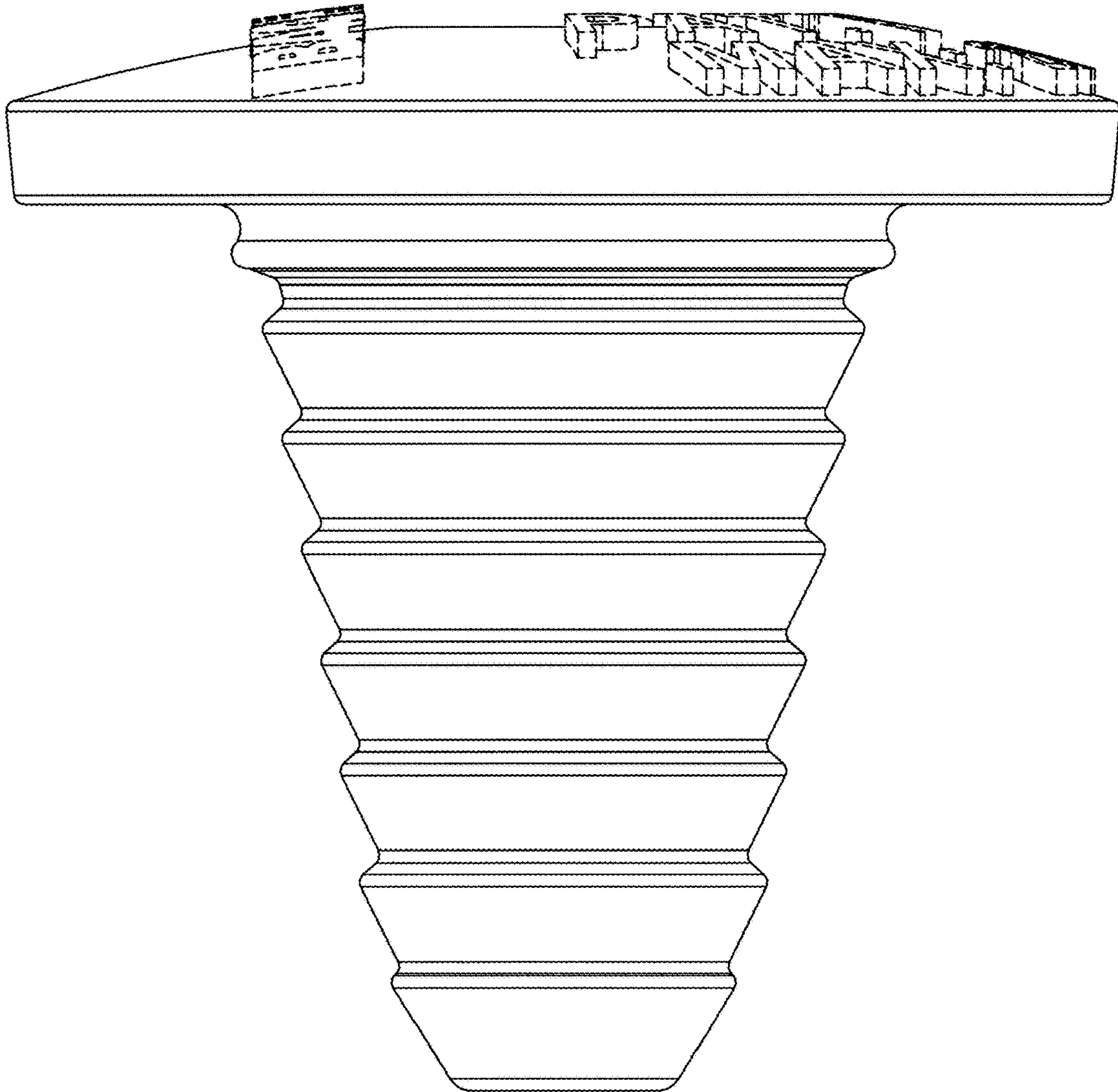

FIG. 7

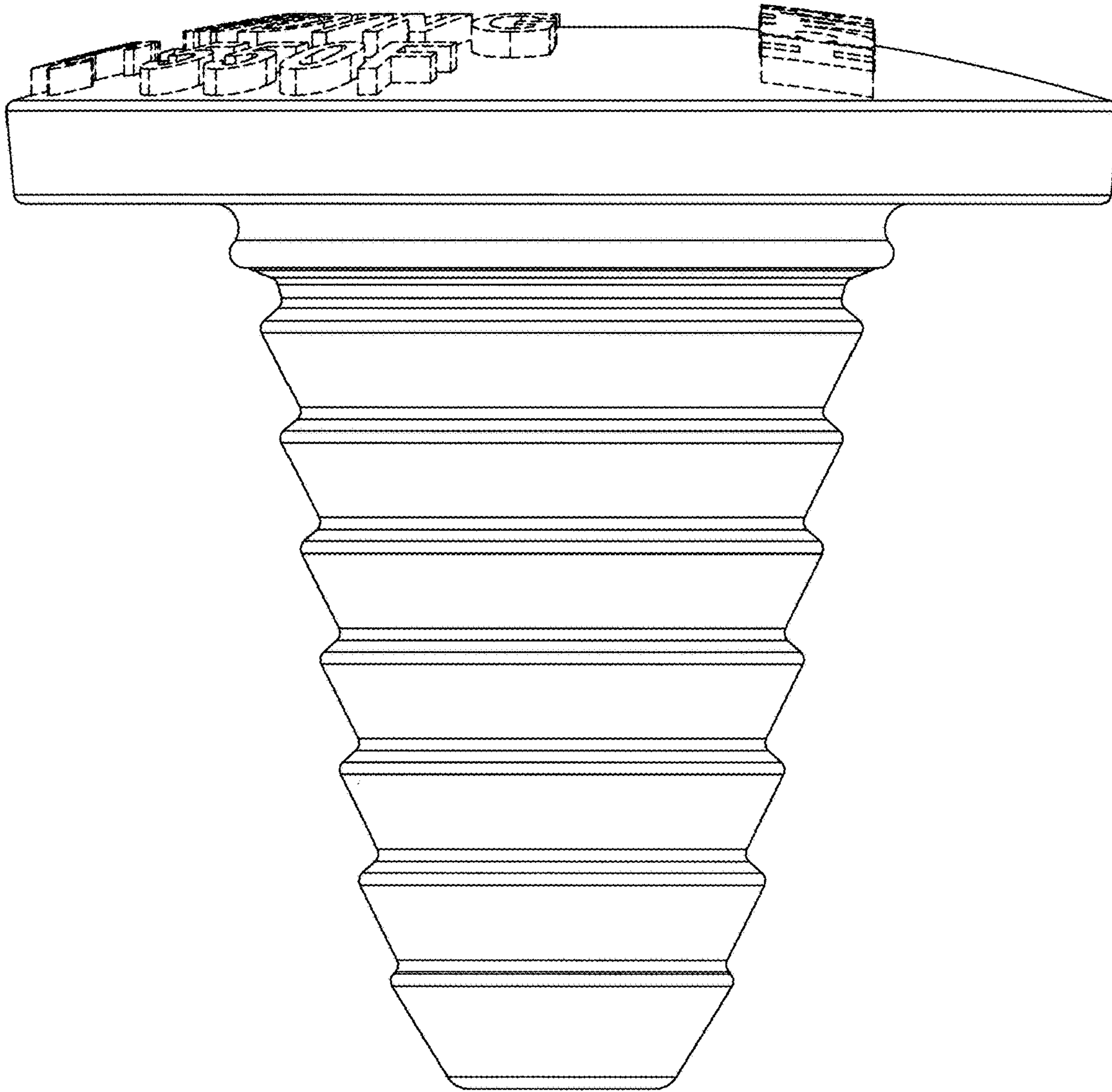

FIG. 8