



US00D844082S

(12) **United States Design Patent**
Shaughnessy

(10) **Patent No.:** **US D844,082 S**

(45) **Date of Patent:** **** Mar. 26, 2019**

- (54) **SOCCER GOAL**
- (71) Applicant: **Christopher Shaughnessy**, Stalybridge (GB)
- (72) Inventor: **Christopher Shaughnessy**, Stalybridge (GB)

- 1,742,011 A * 12/1929 Rumsey A47C 29/006
5/97
- 5,404,839 A * 4/1995 Mancuso A01K 63/003
119/246
- D364,273 S * 11/1995 Miller, Jr. D3/318
- 5,762,026 A * 6/1998 Watters A01K 63/003
119/246
- 5,794,567 A * 8/1998 Itzhak A01K 63/003
119/416

(**) Term: **15 Years**

(Continued)

(21) Appl. No.: **29/611,142**

(22) Filed: **Jul. 19, 2017**

(30) **Foreign Application Priority Data**

Jan. 19, 2017 (EM) 003661198-00001

(51) **LOC (11) Cl.** **21-02**

(52) **U.S. Cl.**
USPC **D21/699**

(58) **Field of Classification Search**
USPC D21/699, 702, 705, 706, 708, 712, 718,
D21/722, 788, 790, 797, 811, 814, 820,
D21/824, 835, 836; D6/332, 345.358,
D6/359, 391, 392, 688.1, 707.13, 707.19;
D25/7, 21, 22, 45, 63; 482/35, 36;
446/126; 206/501

CPC E04H 15/20; E04H 2015/201; E06B 9/02;
E06B 9/04; E06B 7/32; E06B 9/0607;
A63G 31/12; A01K 1/0245

See application file for complete search history.

(56) **References Cited**

U.S. PATENT DOCUMENTS

- 318,812 A * 5/1885 Shimoda et al. B65D 9/14
119/474
- 1,005,886 A * 10/1911 Ruff A01K 31/18
119/491

OTHER PUBLICATIONS

“Kojesledeci Frame coffee table”, posted date not available [online], [retrived May 8, 2018]. Retreived from internet: <http://kojesledeci.conn/x-frame-coffee-table/>.*

(Continued)

Primary Examiner — Barbara Fox

Assistant Examiner — Mehri F Bajoul

(74) *Attorney, Agent, or Firm* — Gavin J.

Milczarek-Desai; Quarles & Brady LLP

(57)

CLAIM

The ornamental design for a soccer goal, as shown and described.

DESCRIPTION

FIG. 1 is a perspective view of a goal embodying my new design.

FIG. 2 is a front elevational view of the design in FIG. 1.

FIG. 3 is a top view of the design in FIG. 1.

FIG. 4 is a bottom view of the design in FIG. 1.

FIG. 5 is a right view of the design in FIG. 1; and,

FIG. 6 is a left view of the design in FIG. 1.

1 Claim, 6 Drawing Sheets

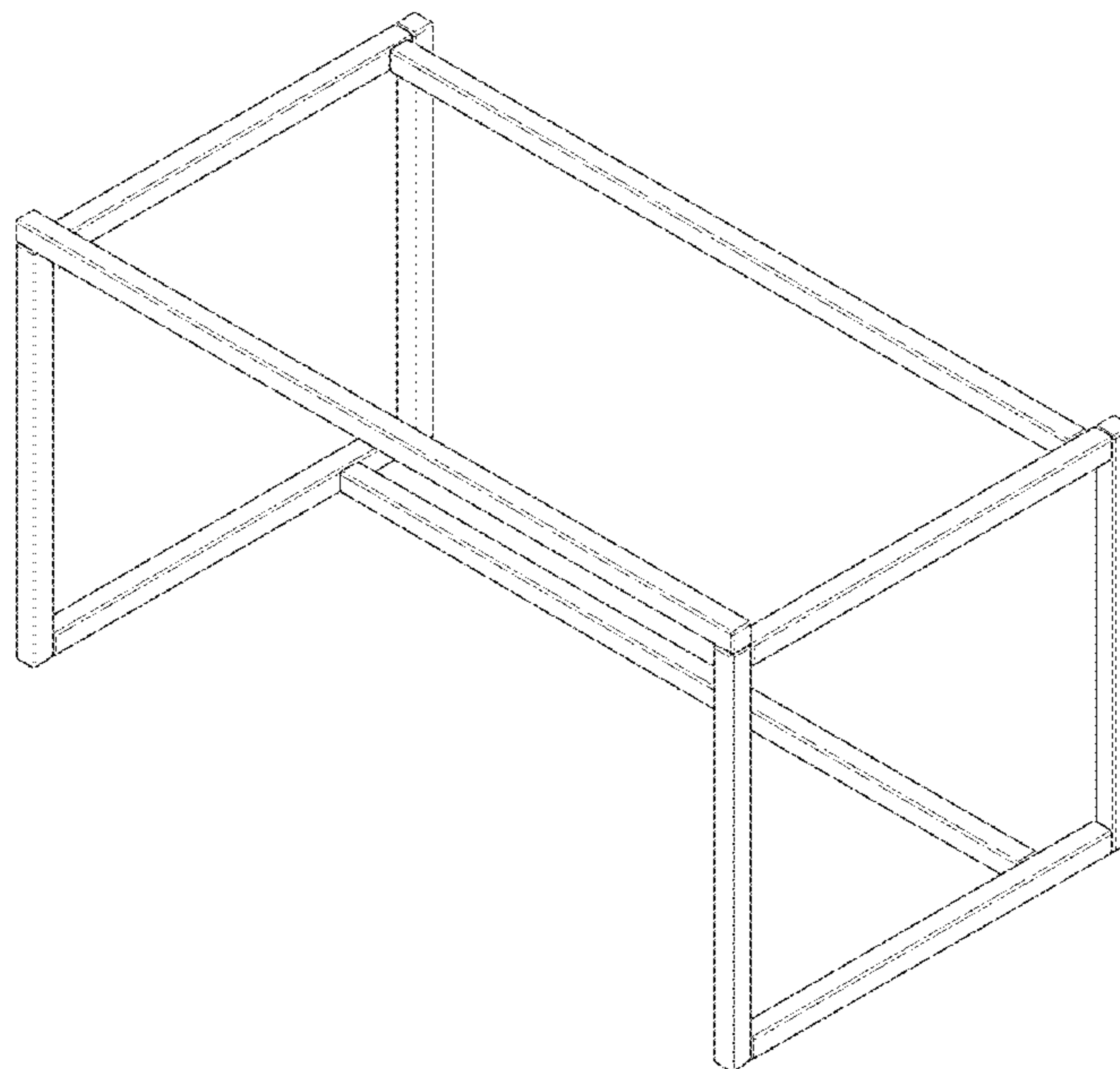

(56)

References Cited

U.S. PATENT DOCUMENTS

5,839,733 A * 11/1998 Meeks A63B 63/004
273/400
5,970,539 A * 10/1999 McDermott, Jr. A47D 15/00
5/100
D509,548 S * 9/2005 Heitzman D21/662
D568,550 S * 5/2008 Totty D30/158
8,234,995 B2 * 8/2012 Dempsey A63B 63/004
116/303
9,363,978 B2 * 6/2016 Mihlbauer A01K 63/003
D798,507 S * 9/2017 Haakman D30/119
2001/0054394 A1 * 12/2001 Marchioro A01K 1/0245
119/452
2005/0202393 A1 * 9/2005 Morgan A47B 97/00
434/365
2006/0150917 A1 * 7/2006 Morton A01K 1/0245
119/498
2008/0110412 A1 * 5/2008 Shimoda A01K 1/034
119/473
2010/0294206 A1 * 11/2010 Kaneda A01K 1/03
119/501
2015/0057113 A1 * 2/2015 Phillips A63B 63/004
473/478
2016/0192615 A1 * 7/2016 Parness A01K 1/034
119/454

OTHER PUBLICATIONS

“Box frame”, posted Jan. 7, 2015 [online], [retrived May 8, 2018].
Retreived from internet: https://tineye.com/search/ca8415cba39c9ec721aa8fab21f784de54b5c547/?extension_ver=chrome-1.2.0.*
“Torrahmen”, posted date not available [online], [retrived May 8, 2018].
Retreived from internet: https://www.artec-sportgeraete.de/produkte/bolztore-1/torraahmen-aus-rechteckprofil/bolztor-vandalomega.html.*
“Sport themed Bedroom Furniture”, posted Dec. 5, 2017 [online],
[retrived May 8, 2018]. Retreived from internet: http://www.sgplus.me/sports-themed-bedroom-furniture/sports-themed-bedroom-furniture-soccer-goal-twin-bed-sports-themed-furniture-baseball-themed-bedroom-furniture/*
“Jpro club Aluminum Square Soccer Goal”, posted Sep. 7, 2017
[online], [retrived May 8, 2018]. Retreived from internet: https://www.helogoal.com/en/mini-goals/portable-mini-soccer-goal-with-playersprotect-26h-x-39w.html.*
“Top flight easylife soccer goal”, posted 2017 [online], [retrived
May 8, 2018]. Retreived from internet: https://www.markharrod.com/product/top-flight-aluminium-mini-soccer-goal-package/*

* cited by examiner

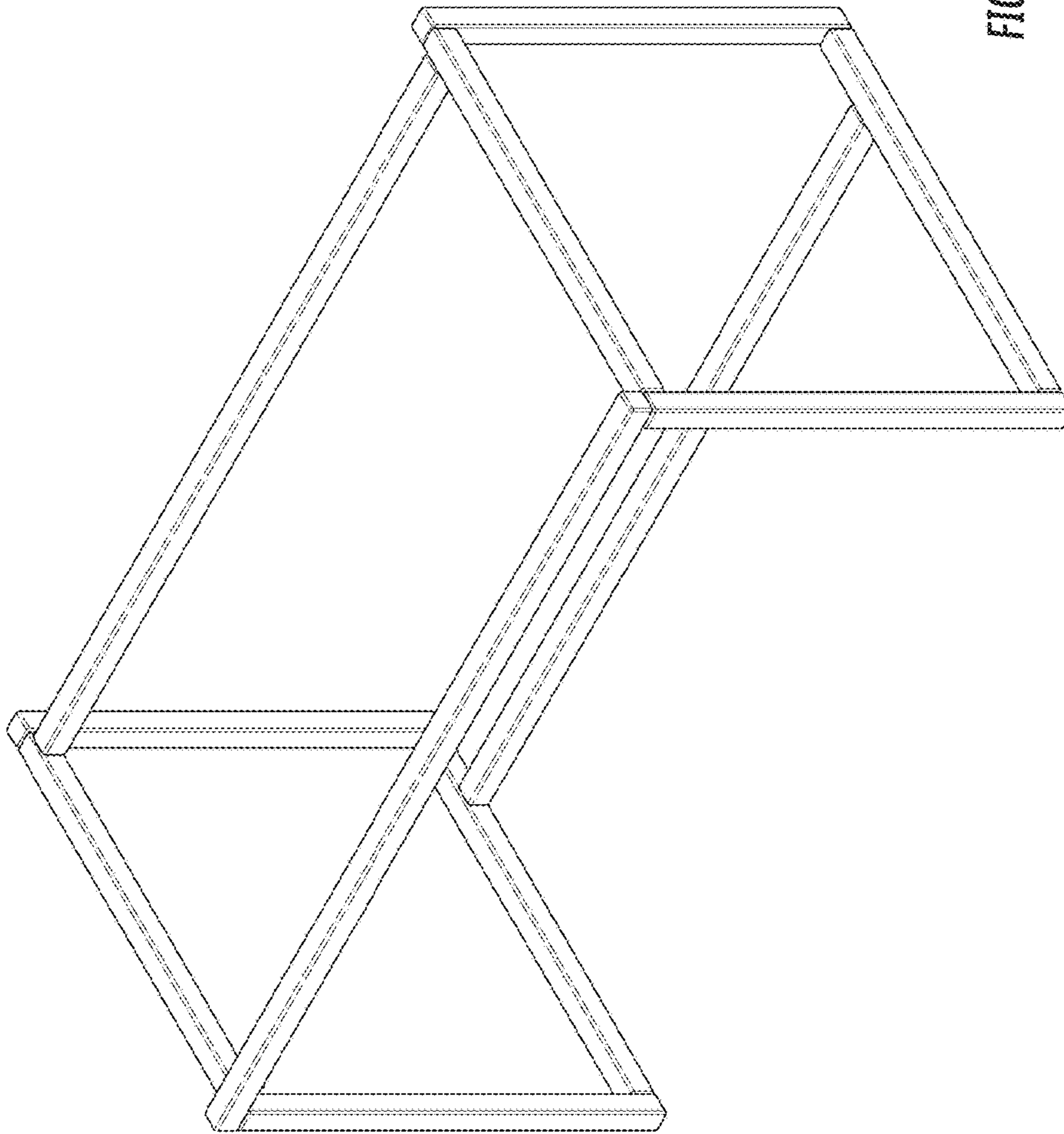

FIG. 1

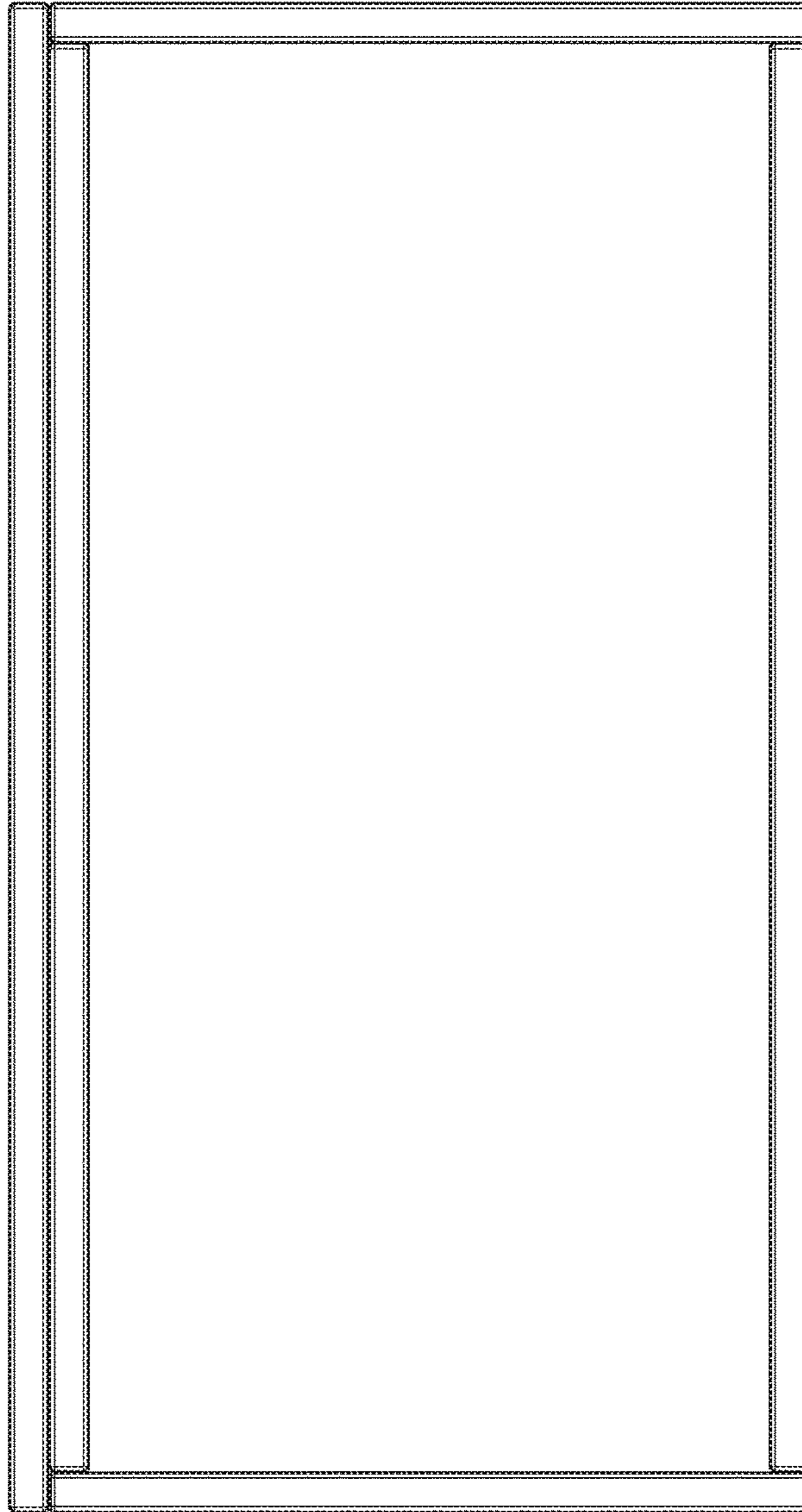

FIG. 2

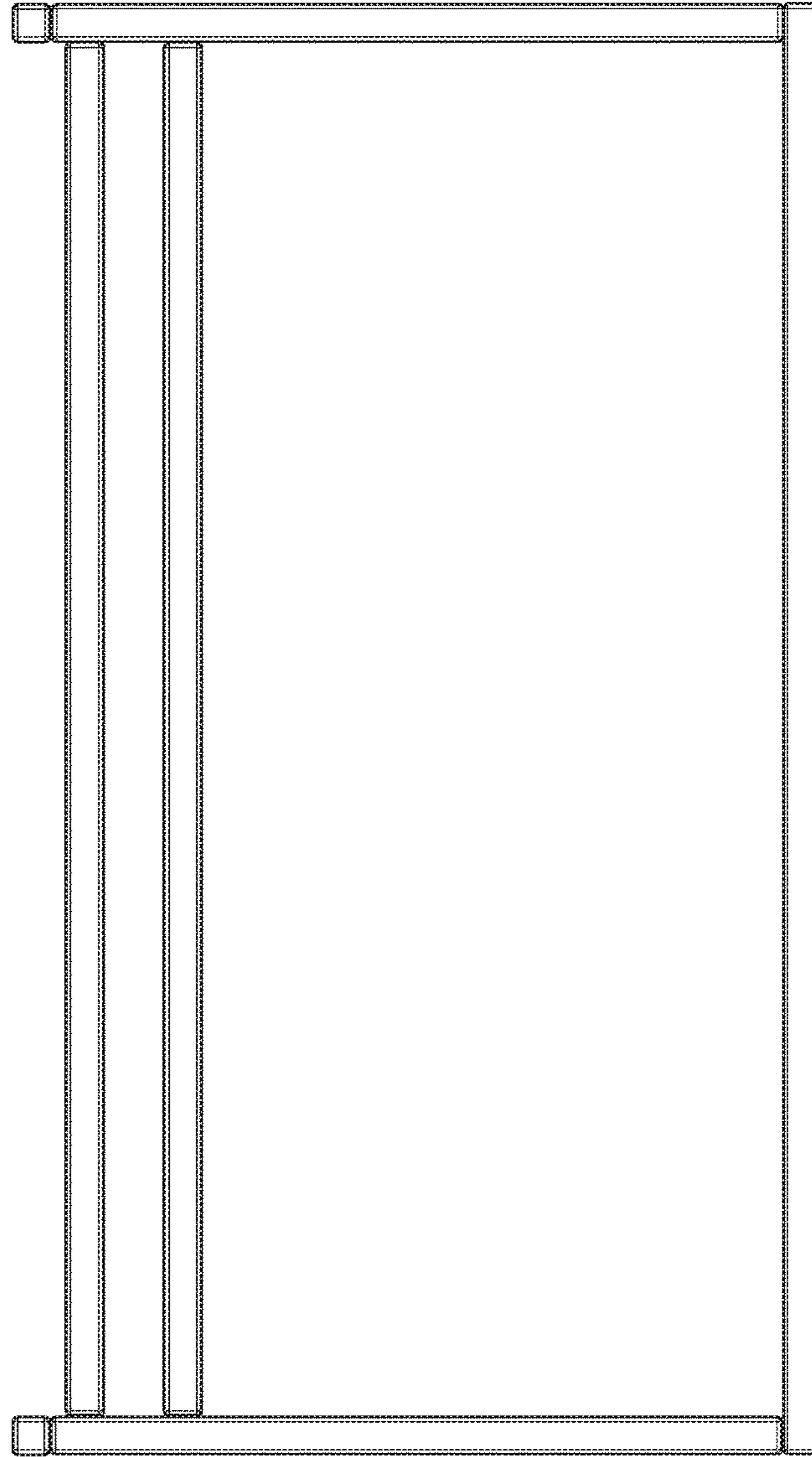

FIG. 3

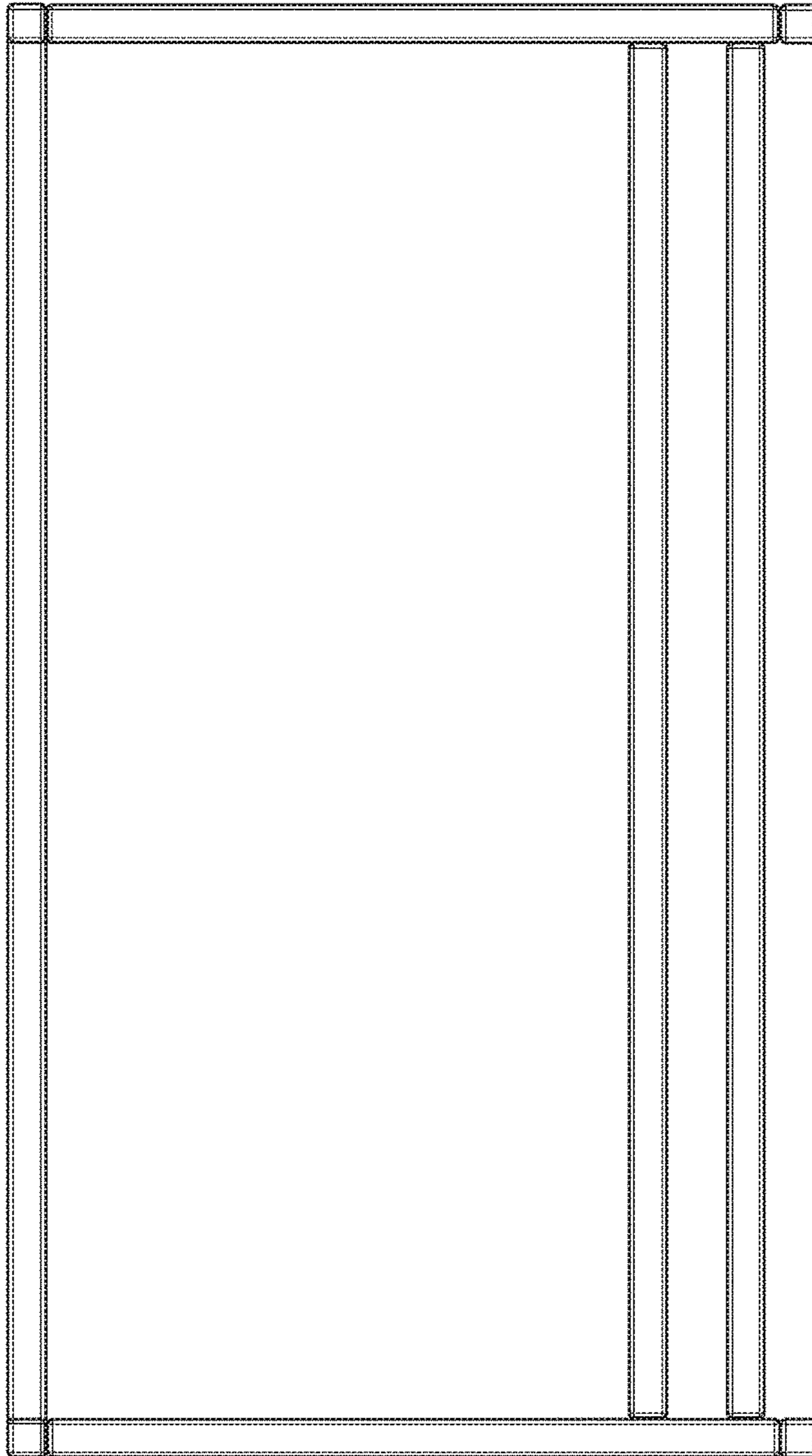

FIG. 4

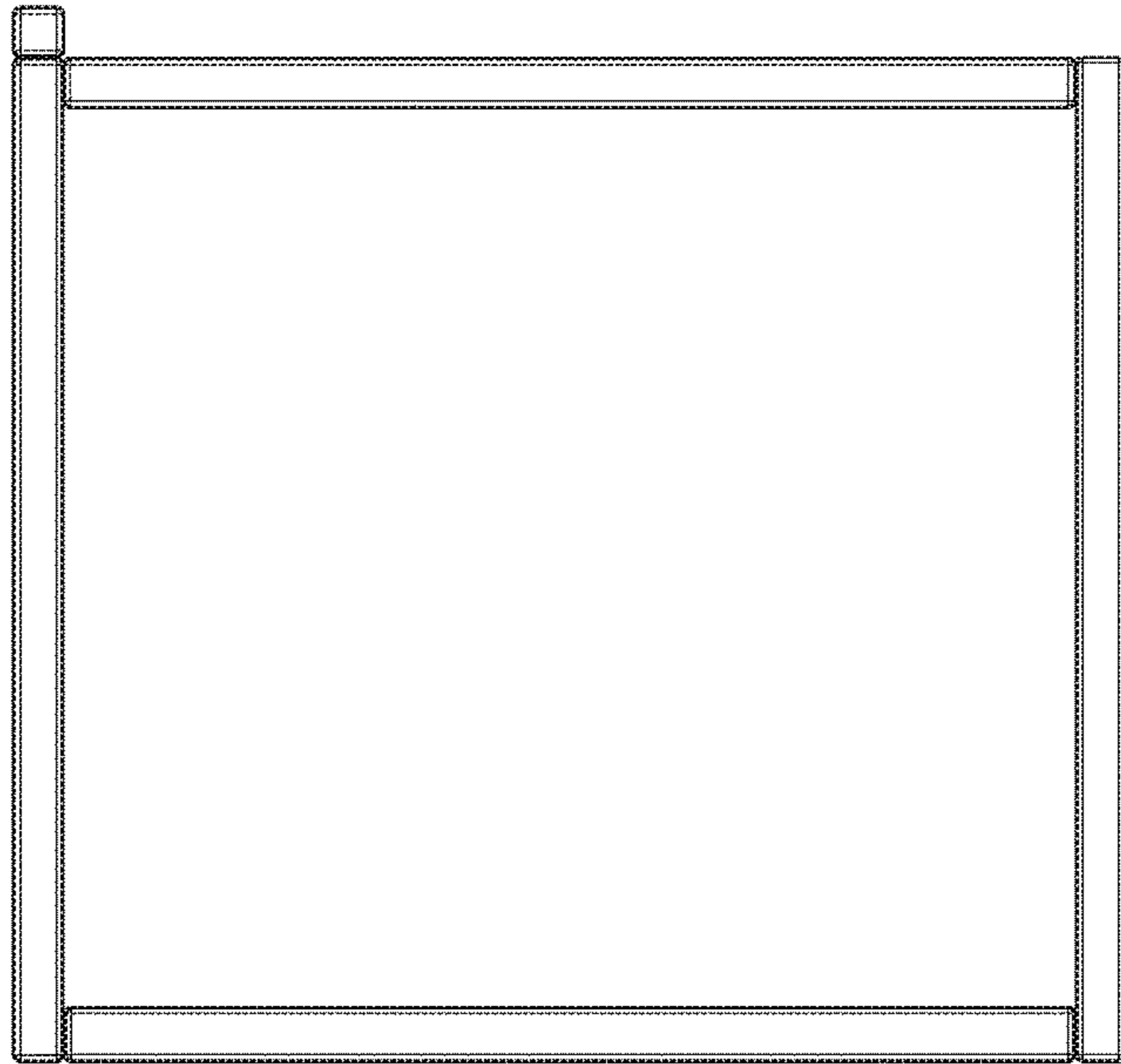

FIG. 5

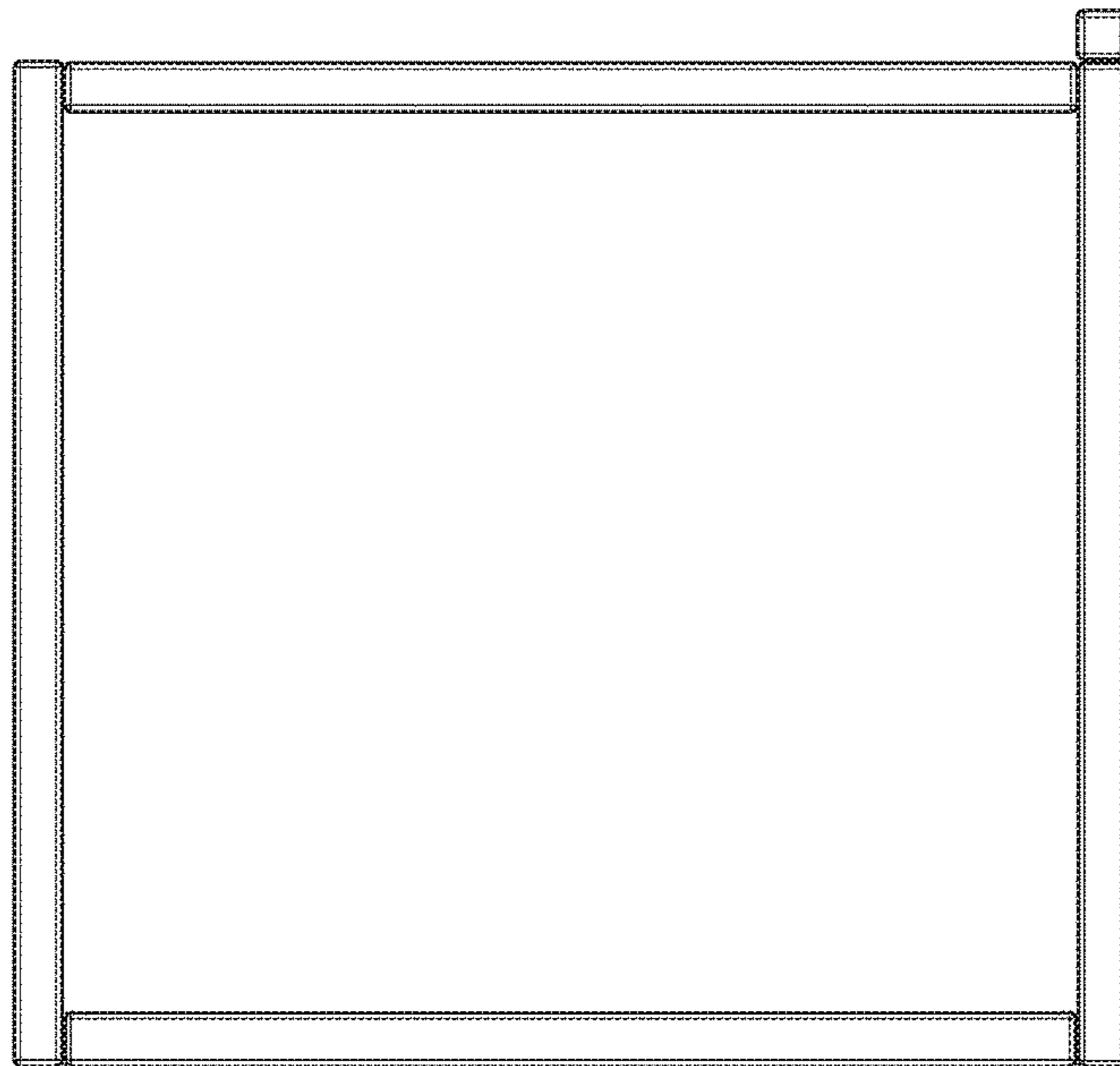

FIG. 6