



US00D844054S

(12) **United States Design Patent**
Bindra

(10) **Patent No.:** **US D844,054 S**

(45) **Date of Patent:** **** Mar. 26, 2019**

(54) **WRITING INSTRUMENT**

(71) Applicant: **Fibro Source U.S.A. Inc.**, San Diego, CA (US)

(72) Inventor: **Sarvjeet S. Bindra**, San Diego, CA (US)

(73) Assignee: **Fibro Source U.S.A. Inc.**, San Diego, CA (US)

(**) Term: **15 Years**

(21) Appl. No.: **29/591,843**

(22) Filed: **Jan. 24, 2017**

(51) **LOC (11) Cl.** **19-06**

(52) **U.S. Cl.**
USPC **D19/166; D19/912**

(58) **Field of Classification Search**
USPC D19/196, 187, 179, 177, 176, 175, 173, D19/169, 153, 117, 113, 164, 166, 912
CPC B43K 24/03; B43K 23/12; B43K 23/001; G09B 5/04; G06F 3/03545
See application file for complete search history.

(56) **References Cited**

U.S. PATENT DOCUMENTS

4,382,706 A	5/1983	Hashimoto et al.	
D330,389 S	* 10/1992	Katami	D19/195
D341,623 S	* 11/1993	Chuang	401/57
D345,759 S	* 4/1994	Poisson	D19/195
D357,276 S	* 4/1995	Bruhn	D19/168
D378,761 S	* 4/1997	Sekine	D19/165
D395,672 S	* 6/1998	Navarro	D19/159
D402,693 S	12/1998	Sunaga	
D408,057 S	4/1999	Izushima	
D410,030 S	5/1999	Sunaga	
D410,681 S	6/1999	Izushima	
D410,682 S	6/1999	Izushima	
D412,014 S	7/1999	Izushima	
D418,163 S	12/1999	Rosen	

D418,870 S	1/2000	Polidoro
D418,871 S	1/2000	Keda
D423,577 S	4/2000	Baudino et al.
6,203,225 B1	3/2001	Baudino et al.
D441,017 S	4/2001	Gault et al.
D444,499 S	7/2001	Nakazawa
D450,769 S	11/2001	Nishida
D453,790 S	2/2002	Tsuchikura
D457,917 S	5/2002	Traut et al.

(Continued)

OTHER PUBLICATIONS

Uni-ball—Power Tank RT; <http://www.uniball-na.com/main.taf?p=2,1,1>; 4 pages; Nov. 27, 2006.

Primary Examiner — Cynthia Ramirez

Assistant Examiner — Laura H Yu

(74) *Attorney, Agent, or Firm* — John F. A. Earley, III; Frank J. Bonini, Jr.; Harding, Earley, Follmer & Frailey, P.C.

(57) **CLAIM**

The ornamental design for a writing instrument, as shown and described.

DESCRIPTION

FIG. 1 is a front, left perspective view of a writing instrument showing my new design; FIG. 2 is a front elevational view thereof; FIG. 3 is a rear elevational view thereof; FIG. 4 is a right side elevational view thereof; FIG. 5 is a left side elevational view thereof; FIG. 6 is a top plan view thereof; and, FIG. 7 is a bottom plan view thereof; and, FIG. 8 is a left side perspective view of the writing instrument of FIG. 1, with the cap removed. The broken lines in the figures are for the purpose of illustrating portions of the writing instrument that form no part of the claimed design.

1 Claim, 7 Drawing Sheets

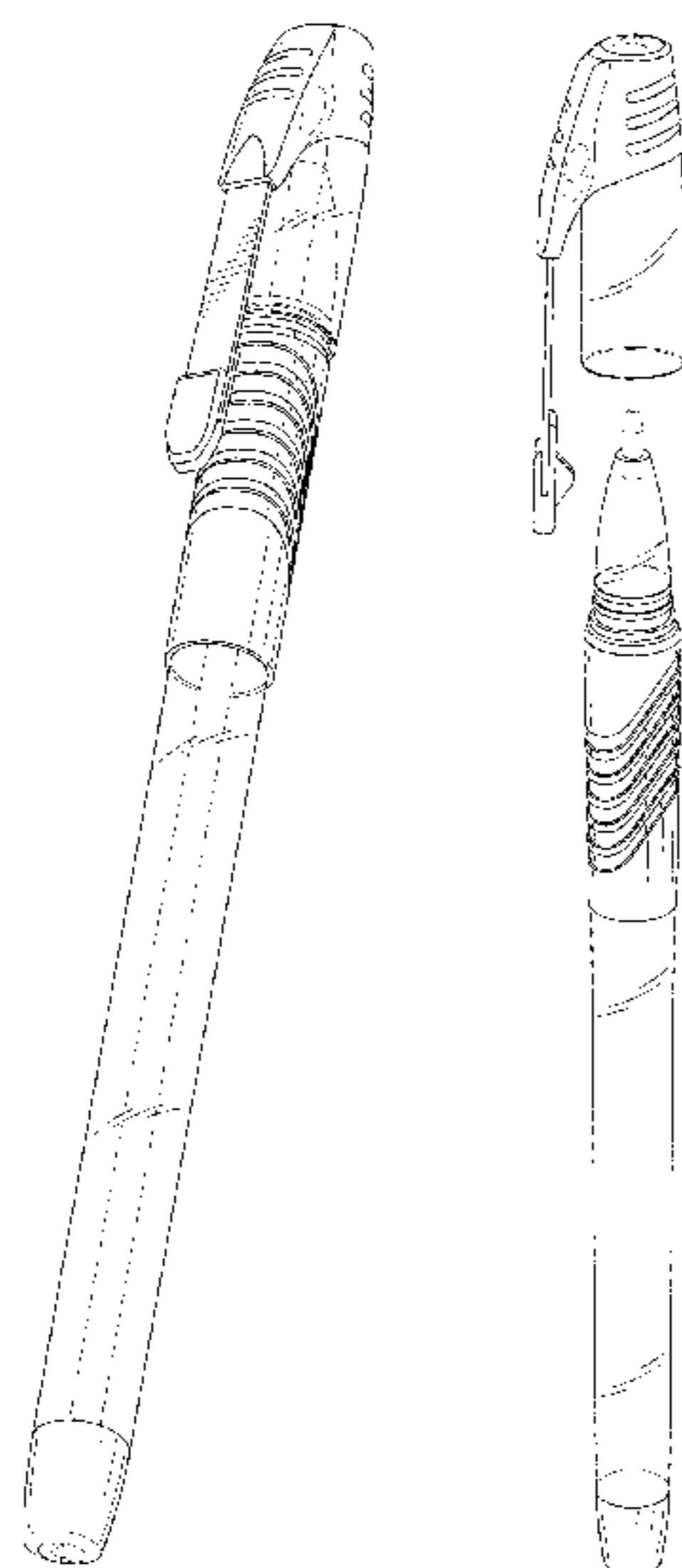

(56)

References Cited

U.S. PATENT DOCUMENTS

D458,306 S 6/2002 Moon
 D463,489 S * 9/2002 Yoon D19/167
 D465,238 S 11/2002 Qiu
 D472,574 S * 4/2003 Andrews D19/169
 D476,364 S 6/2003 Bain
 D482,071 S 11/2003 Kennedy et al.
 D484,187 S 12/2003 Moon
 D492,349 S 6/2004 Qiu
 D492,350 S 6/2004 Morrow
 D495,002 S 8/2004 Sung
 D496,070 S * 9/2004 Furlong D19/195
 D496,688 S 9/2004 Nishida
 D497,643 S 10/2004 Nishida
 D498,791 S 11/2004 Morrow
 D499,142 S 11/2004 Morrow
 D500,520 S 1/2005 Bain et al.
 D500,792 S 1/2005 Bain et al.
 D500,794 S 1/2005 Conklin et al.

D506,500 S * 6/2005 Qiu D19/166
 D506,501 S * 6/2005 Qiu D19/168
 D506,504 S 6/2005 Nakazawa et al.
 D507,301 S 7/2005 Qiu
 D508,717 S 8/2005 Anand
 D508,950 S 8/2005 Kiple et al.
 D534,213 S 12/2006 Hageman et al.
 D541,342 S * 4/2007 Qiu D19/166
 D542,843 S 5/2007 Qiu
 D544,915 S 6/2007 Santa Maria et al.
 D548,791 S 8/2007 Santa Maria et al.
 D550,282 S 9/2007 Neuenschwander et al.
 D559,315 S 1/2008 Qiu et al.
 D562,893 S * 2/2008 Qiu D19/169
 D573,184 S 7/2008 Vadenne
 D590,879 S * 4/2009 Yu D19/168
 D600,282 S 9/2009 Guoguang
 D602,528 S * 10/2009 Takanashi D19/195
 D713,878 S 9/2014 Fleming
 D797,192 S * 9/2017 Casciotti D19/199

* cited by examiner

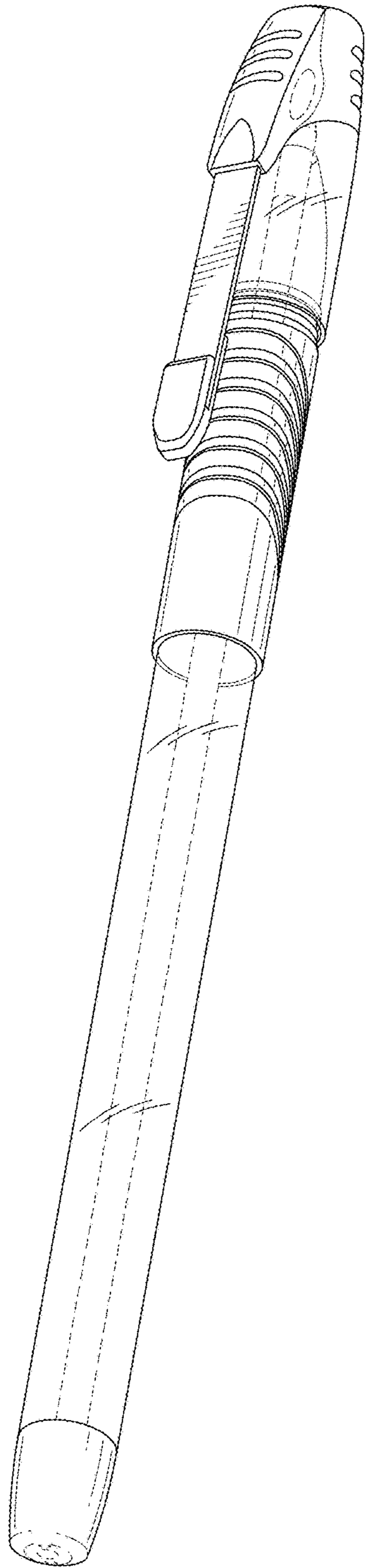

FIG. 1

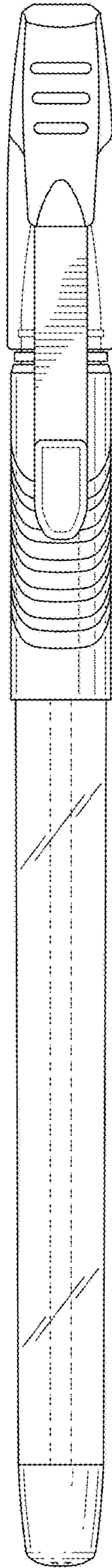

FIG. 2

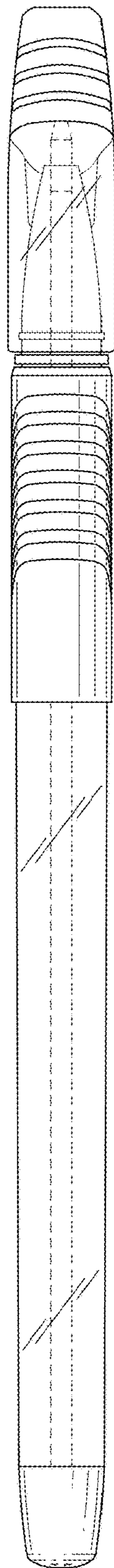

FIG. 3

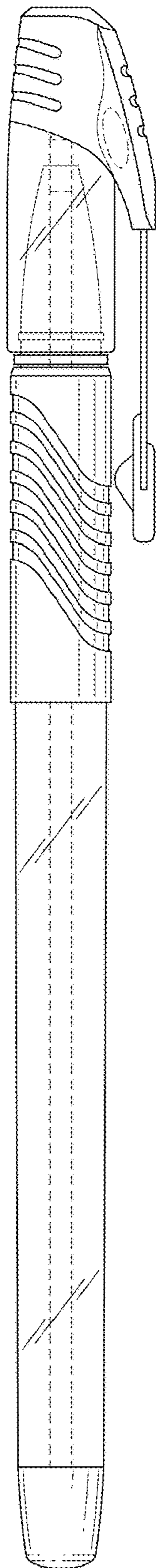

FIG.4

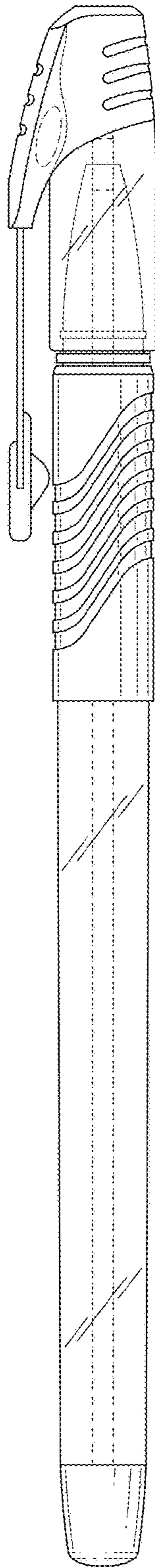

FIG. 5

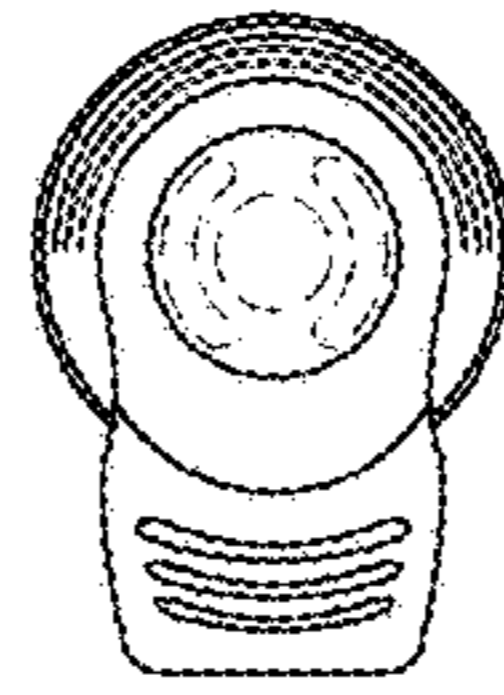

FIG. 6

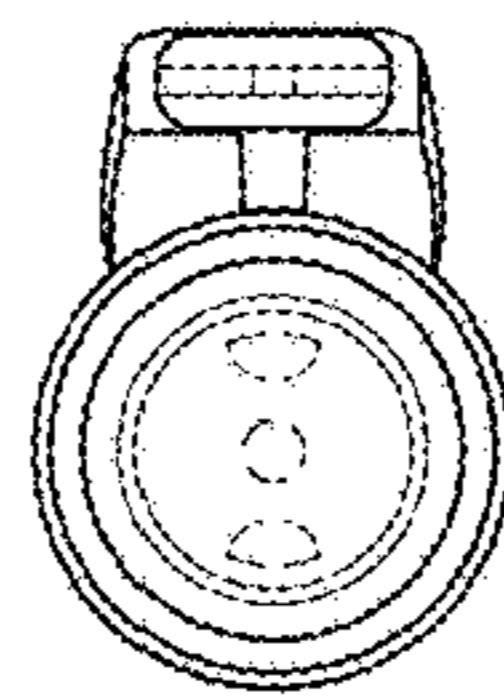

FIG. 7

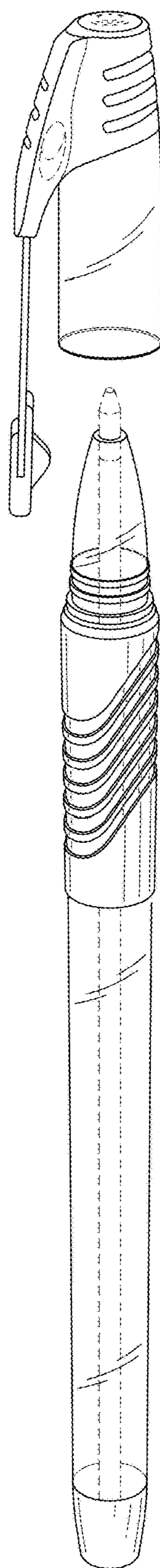

FIG. 8