



US00D843966S

(12) **United States Design Patent**
Cheney

(10) **Patent No.:** **US D843,966 S**

(45) **Date of Patent:** **** Mar. 26, 2019**

(54) **SPEAKER**

(71) Applicant: **Zagg Amplified, Inc.**, Midvale, UT (US)

(72) Inventor: **John Craig Cheney**, Orem, UT (US)

(73) Assignee: **ZAGG Amplified, Inc.**, Midvale, UT (US)

(**) Term: **15 Years**

(21) Appl. No.: **29/589,654**

(22) Filed: **Jan. 3, 2017**

(51) **LOC (11) Cl.** **14-01**

(52) **U.S. Cl.**
USPC **D14/204**

(58) **Field of Classification Search**
USPC D14/188, 204, 209.1, 210–215, 348, 349, D14/352, 498–505; 181/143, 144, 148, 181/153, 157, 198, 199; 369/6–12; 381/300–303, 361–364, 366, 386–388
CPC H04R 1/02; H04R 1/021; H04R 1/025; H04R 1/026; H04R 1/028; H04R 1/403; H04R 1/2803; H04R 1/2834; H04R 5/02; H04R 9/06; H04R 19/013; H04R 2400/00
See application file for complete search history.

(56) **References Cited**

U.S. PATENT DOCUMENTS

D597,064 S * 7/2009 Machida D14/167
D621,384 S * 8/2010 Kao D14/214

D655,272 S * 3/2012 Kawase D14/194
D681,010 S * 4/2013 Cho D14/215
D710,825 S * 8/2014 Florczak D14/214
D711,354 S * 8/2014 Florczak D14/215
D715,766 S * 10/2014 Osborn D14/210
D726,142 S * 4/2015 Itoh D14/196
D727,292 S * 4/2015 Anthony D14/214

* cited by examiner

Primary Examiner — Derrick E Holland

Assistant Examiner — Janice Patyk

(74) *Attorney, Agent, or Firm* — Durham Jones & Pinegar; Sarah W. Matthews

(57) **CLAIM**

The ornamental design for a speaker, as shown and described.

DESCRIPTION

FIG. 1 is a rear perspective view of a speaker, showing our new design.
FIG. 2 is a front perspective view thereof.
FIG. 3 is a front view thereof.
FIG. 4 is a rear view thereof.
FIG. 5 is a right side view thereof.
FIG. 6 is a left side view thereof.
FIG. 7 is a top view thereof; and,
FIG. 8 is a bottom view thereof.
The broken lines in the figures illustrate portions of the design which form no part of the claimed design.

1 Claim, 4 Drawing Sheets

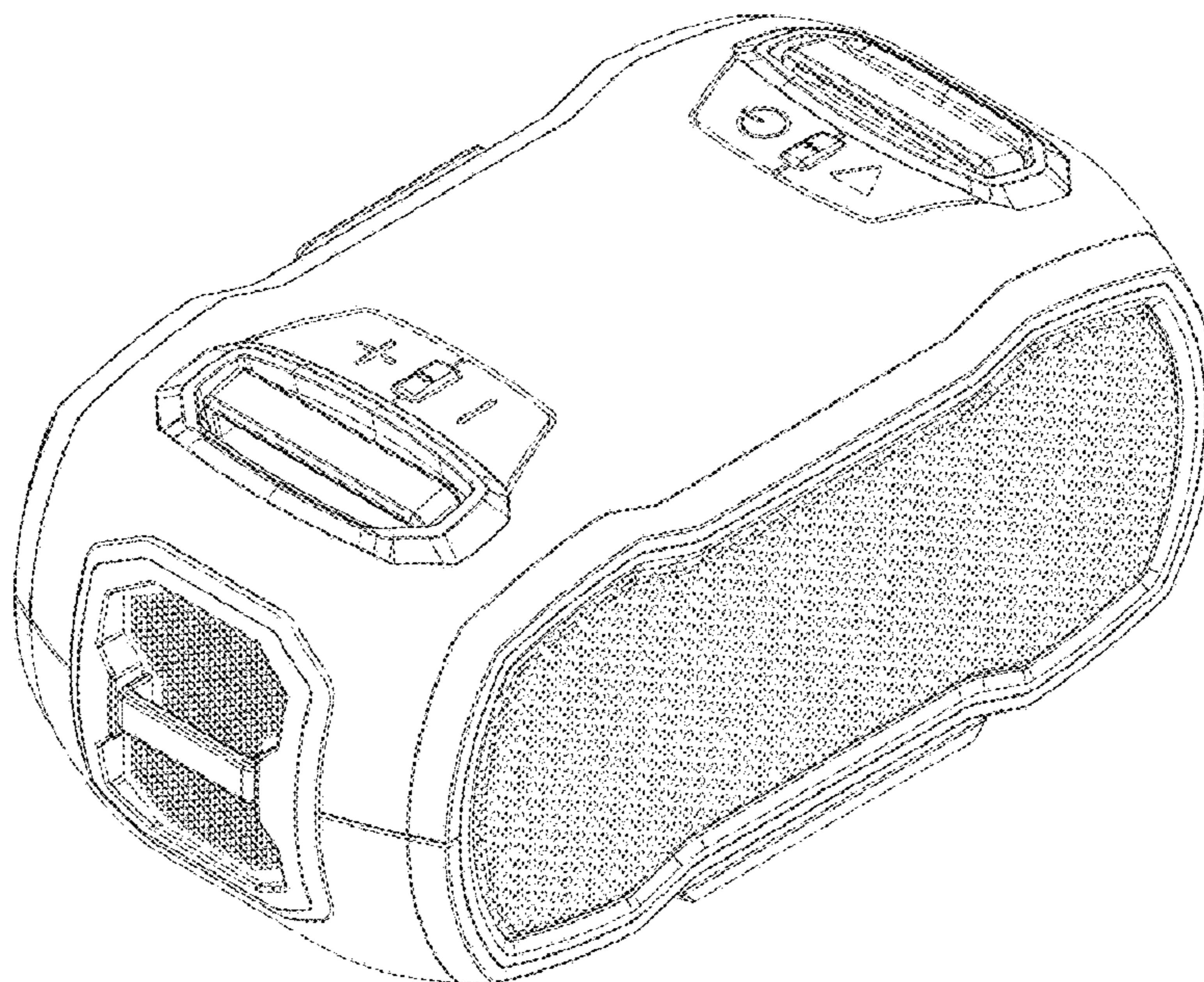

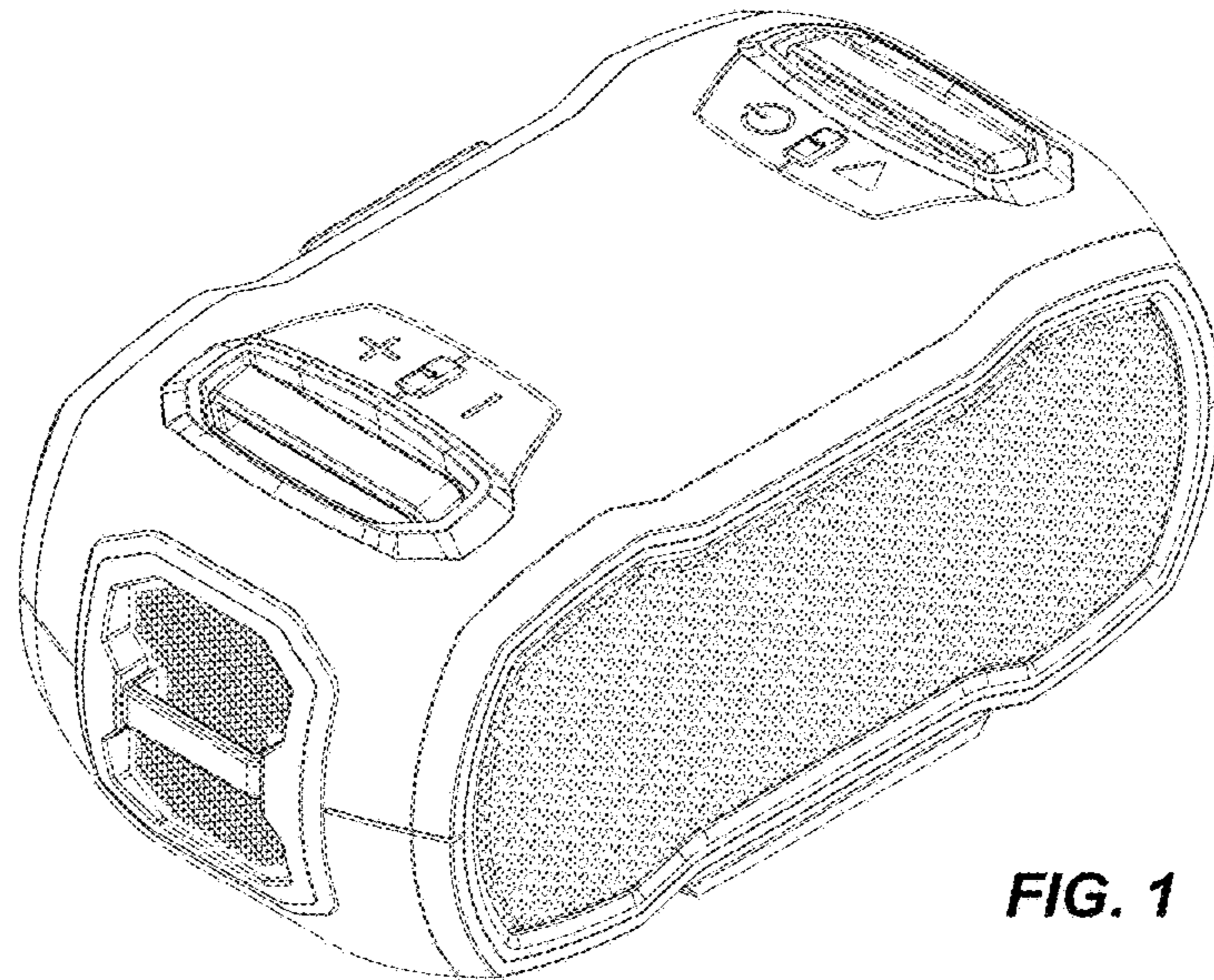

FIG. 1

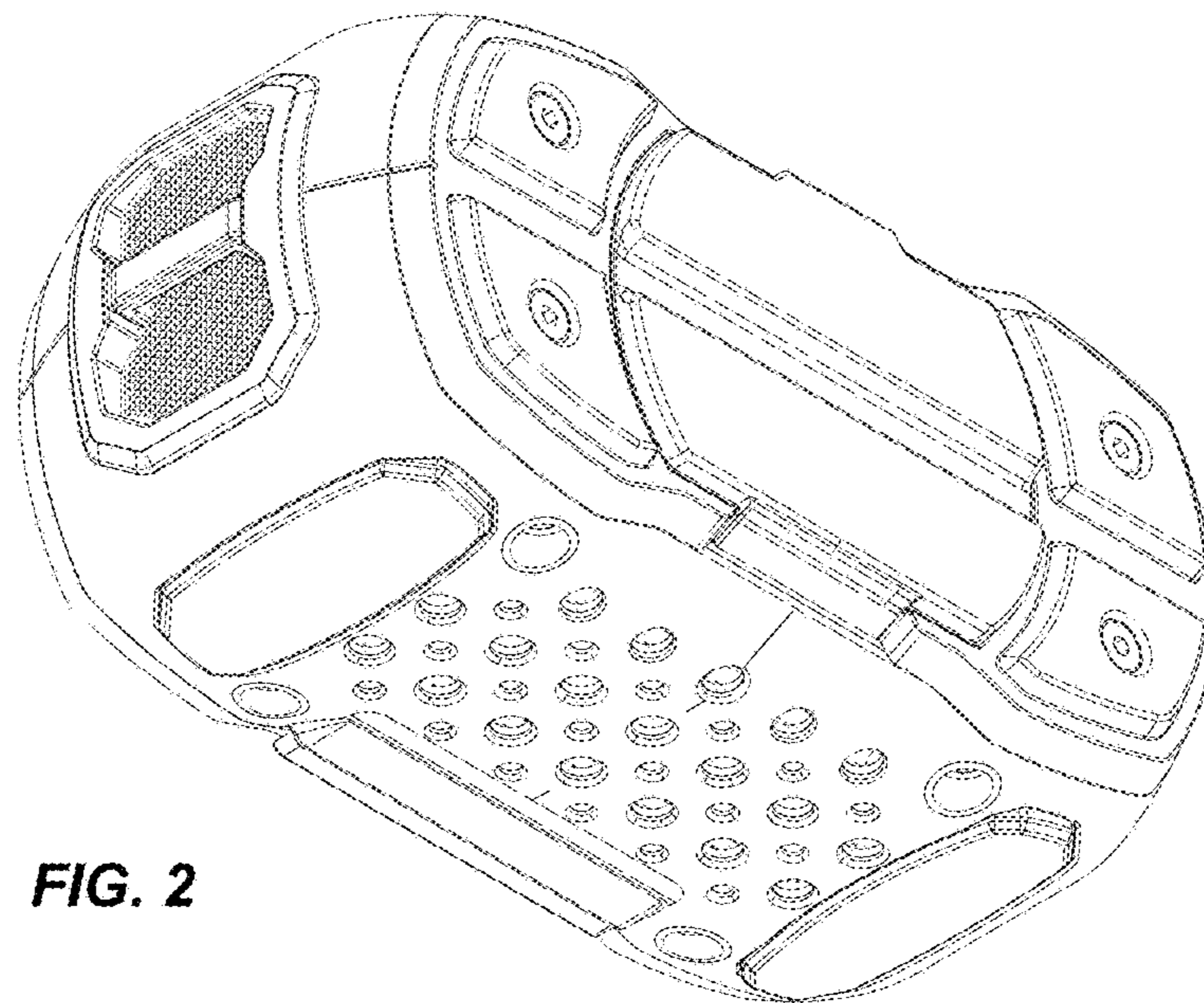

FIG. 2

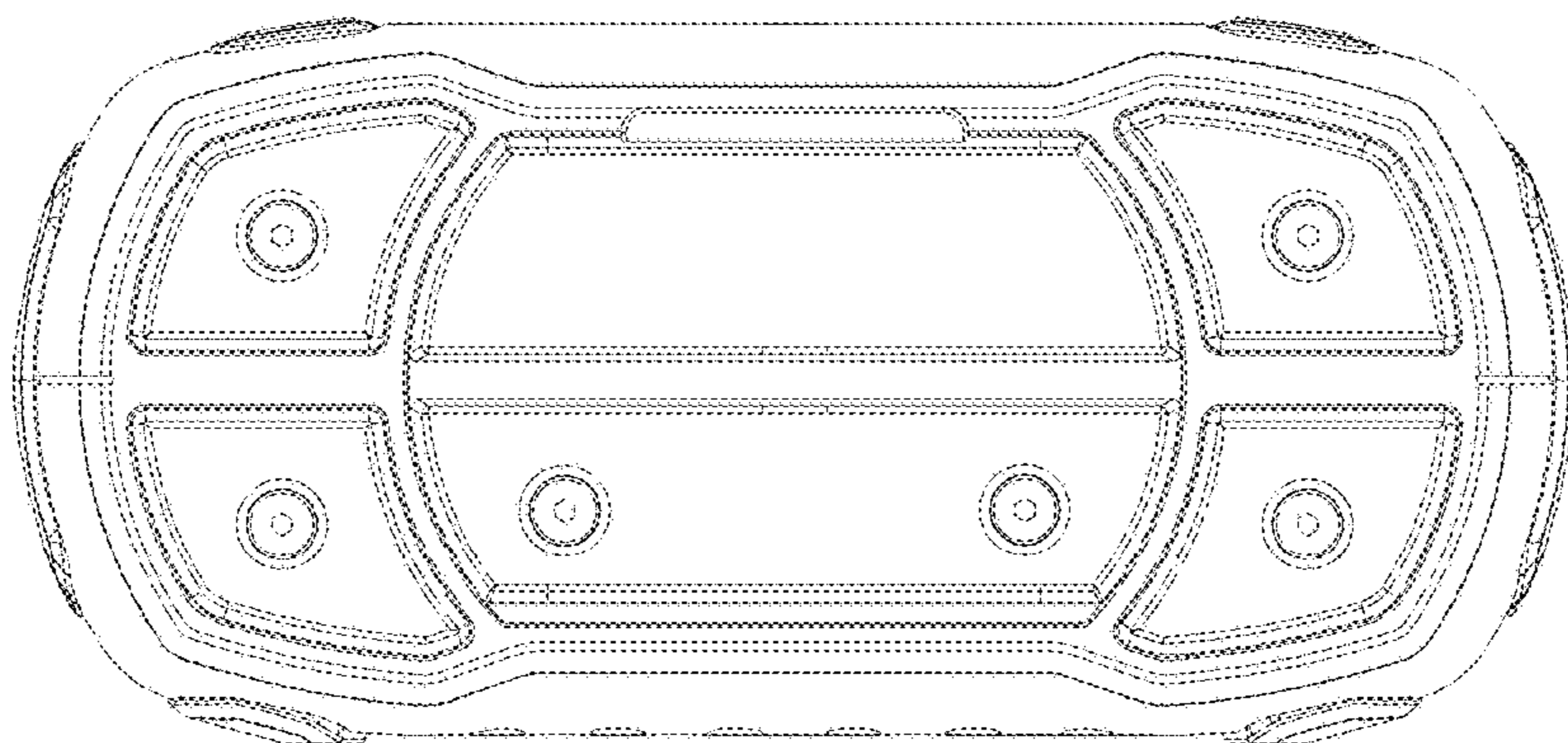

FIG. 3

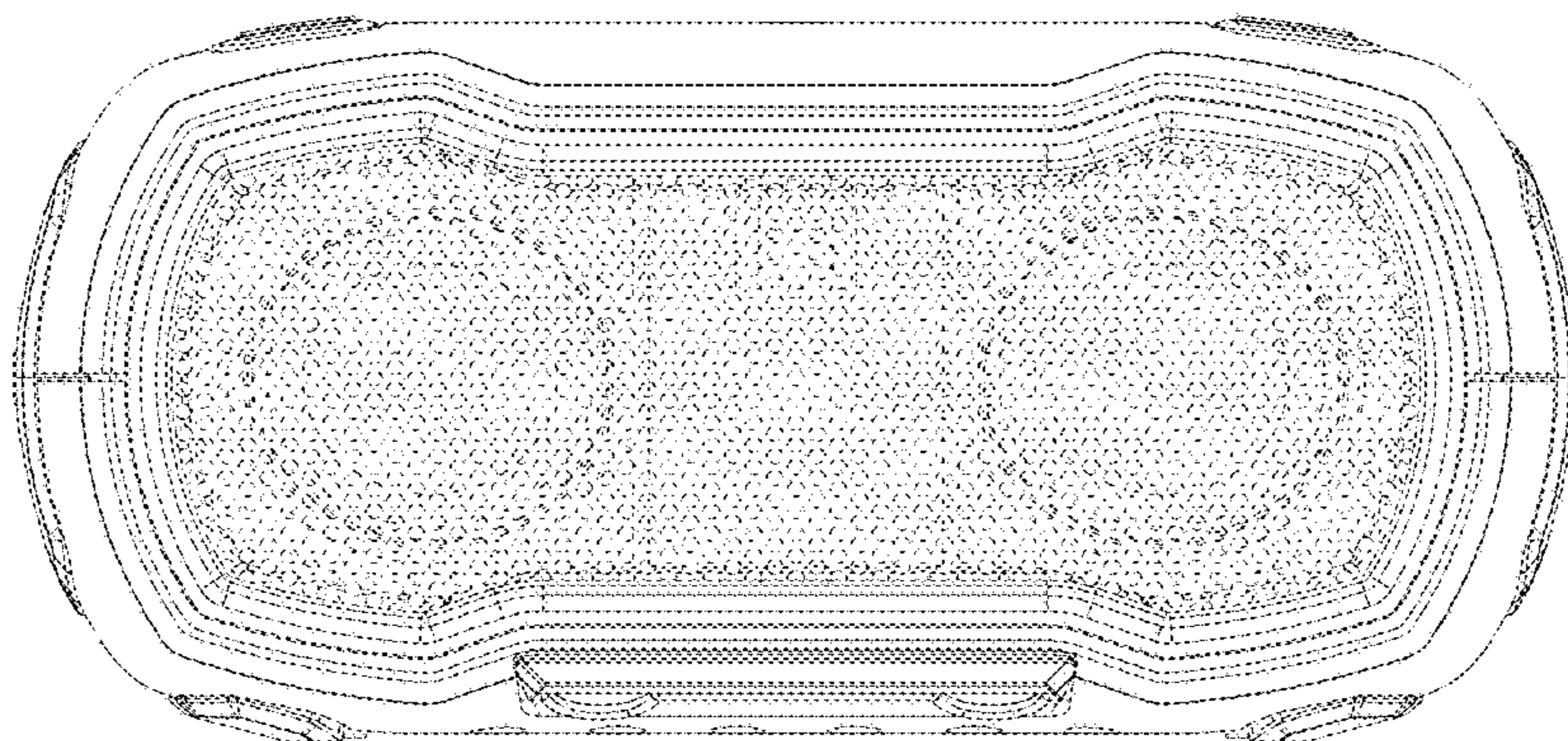

FIG. 4

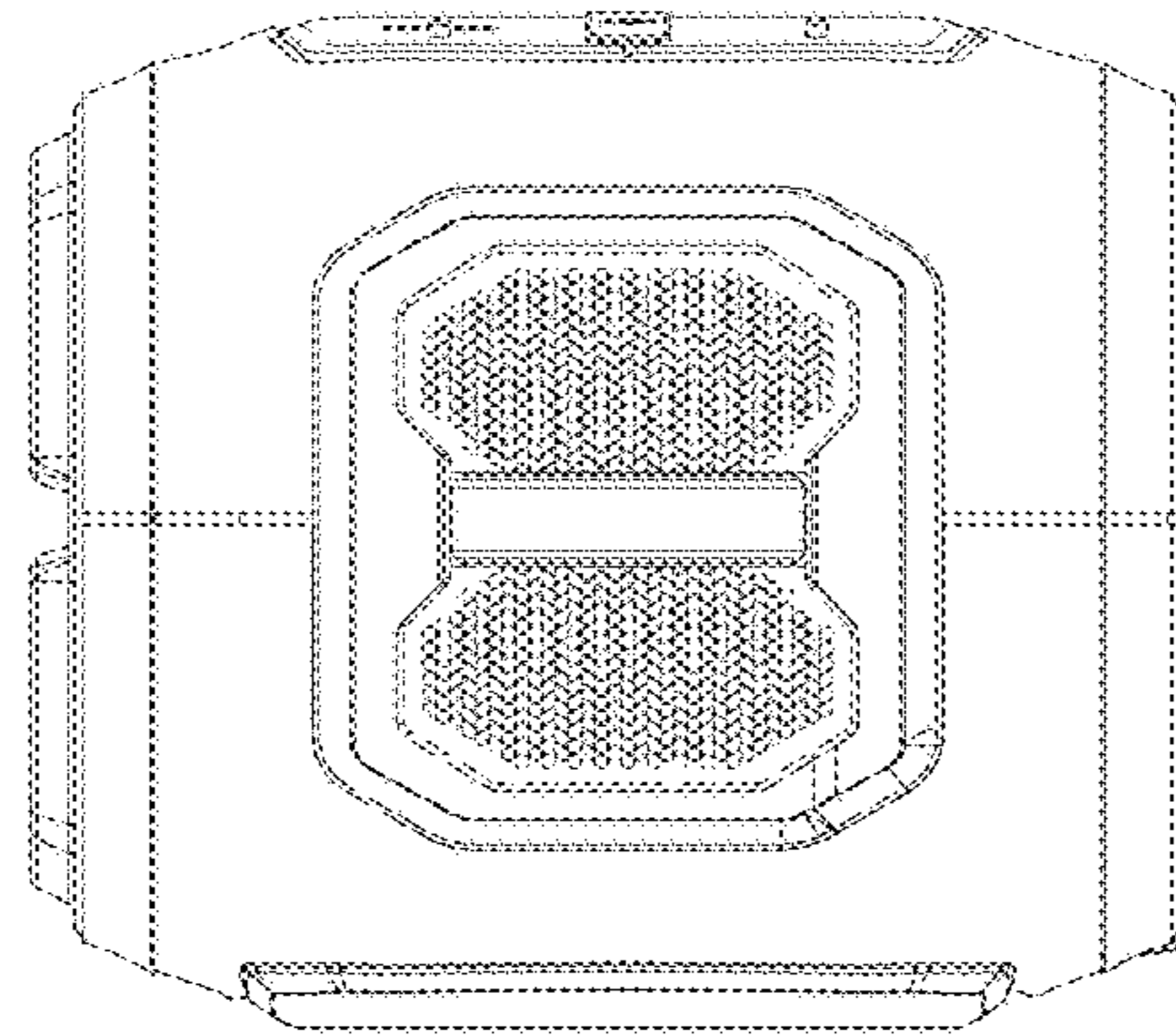

FIG. 5

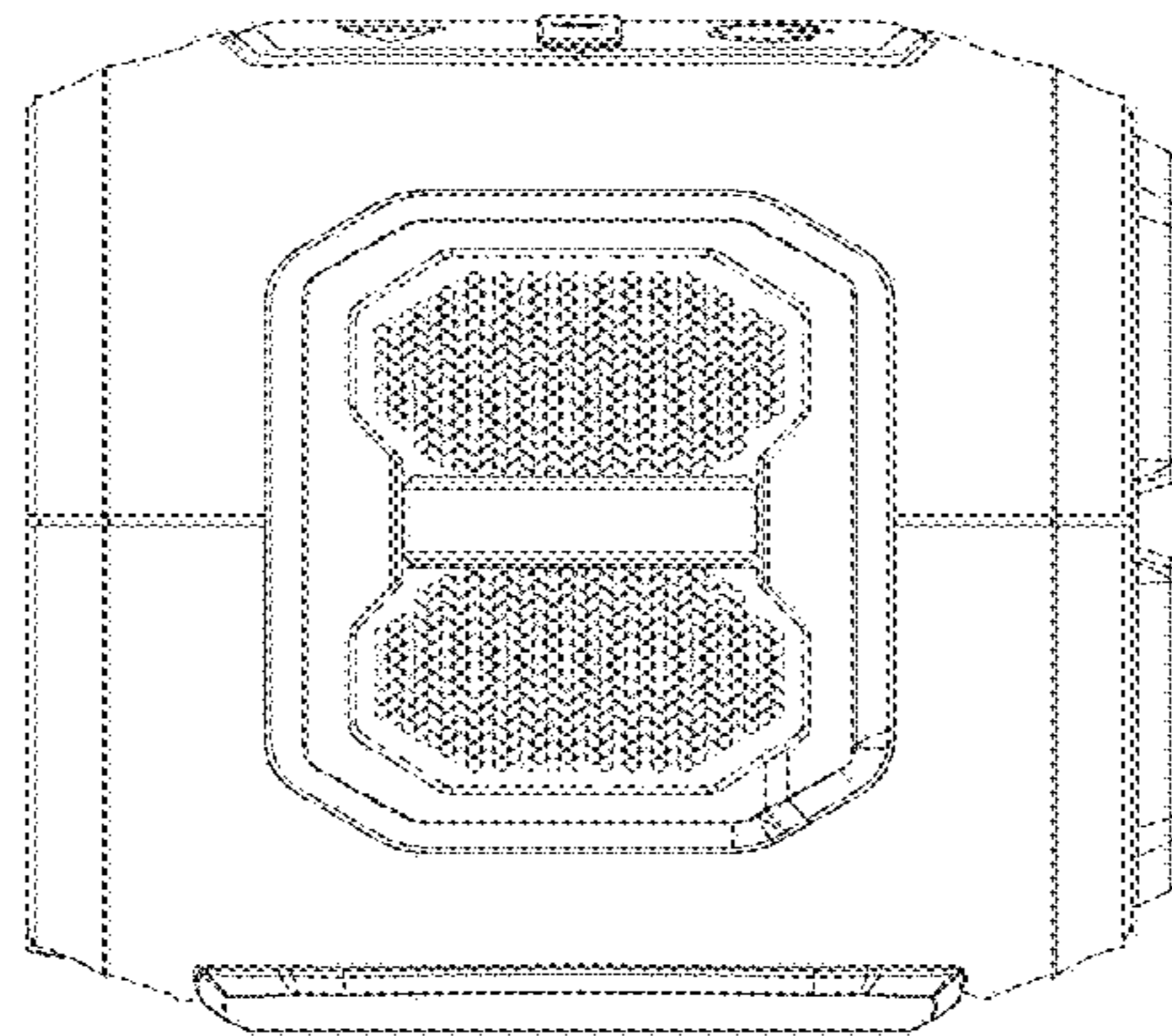

FIG. 6

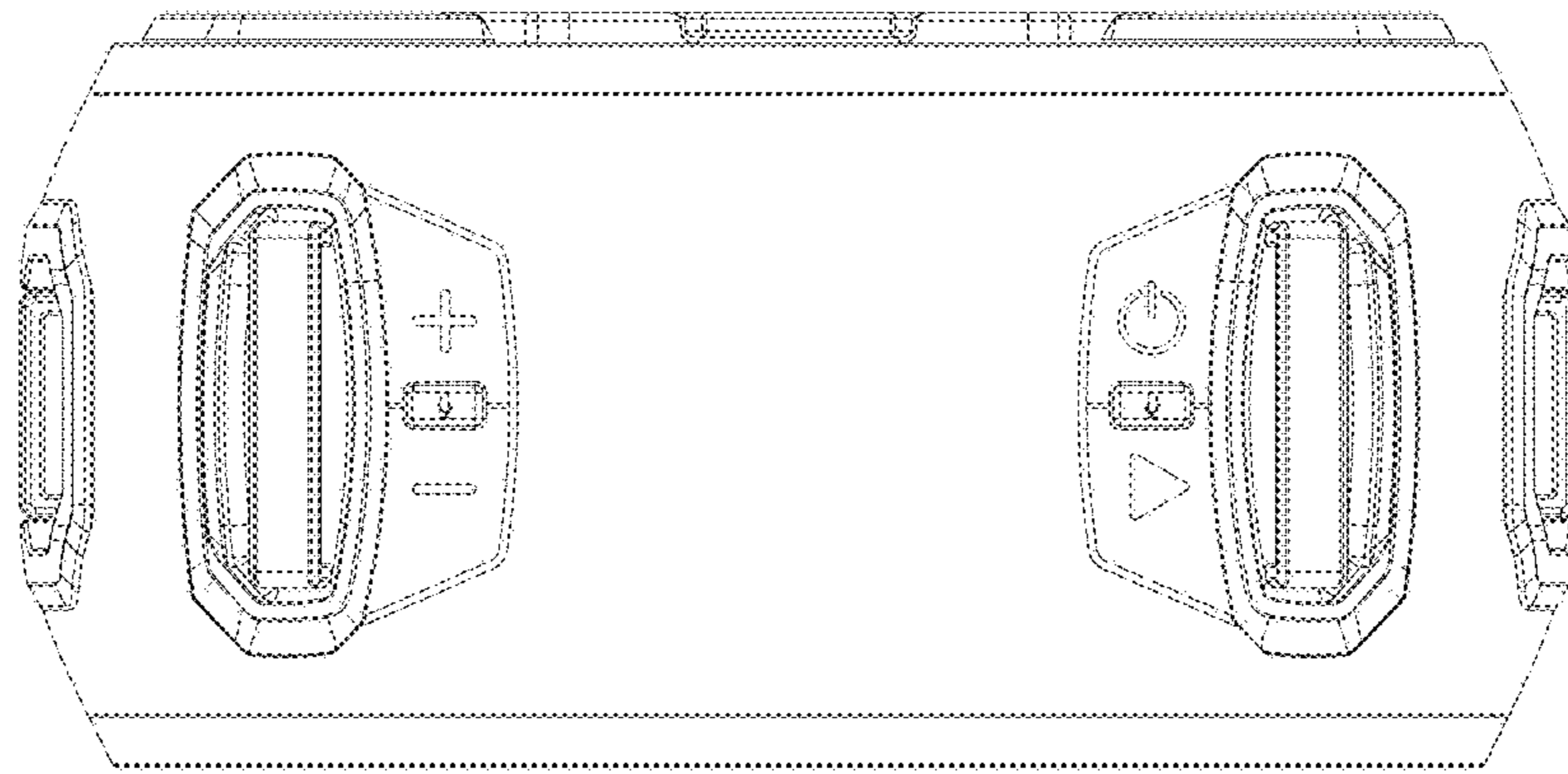

FIG. 7

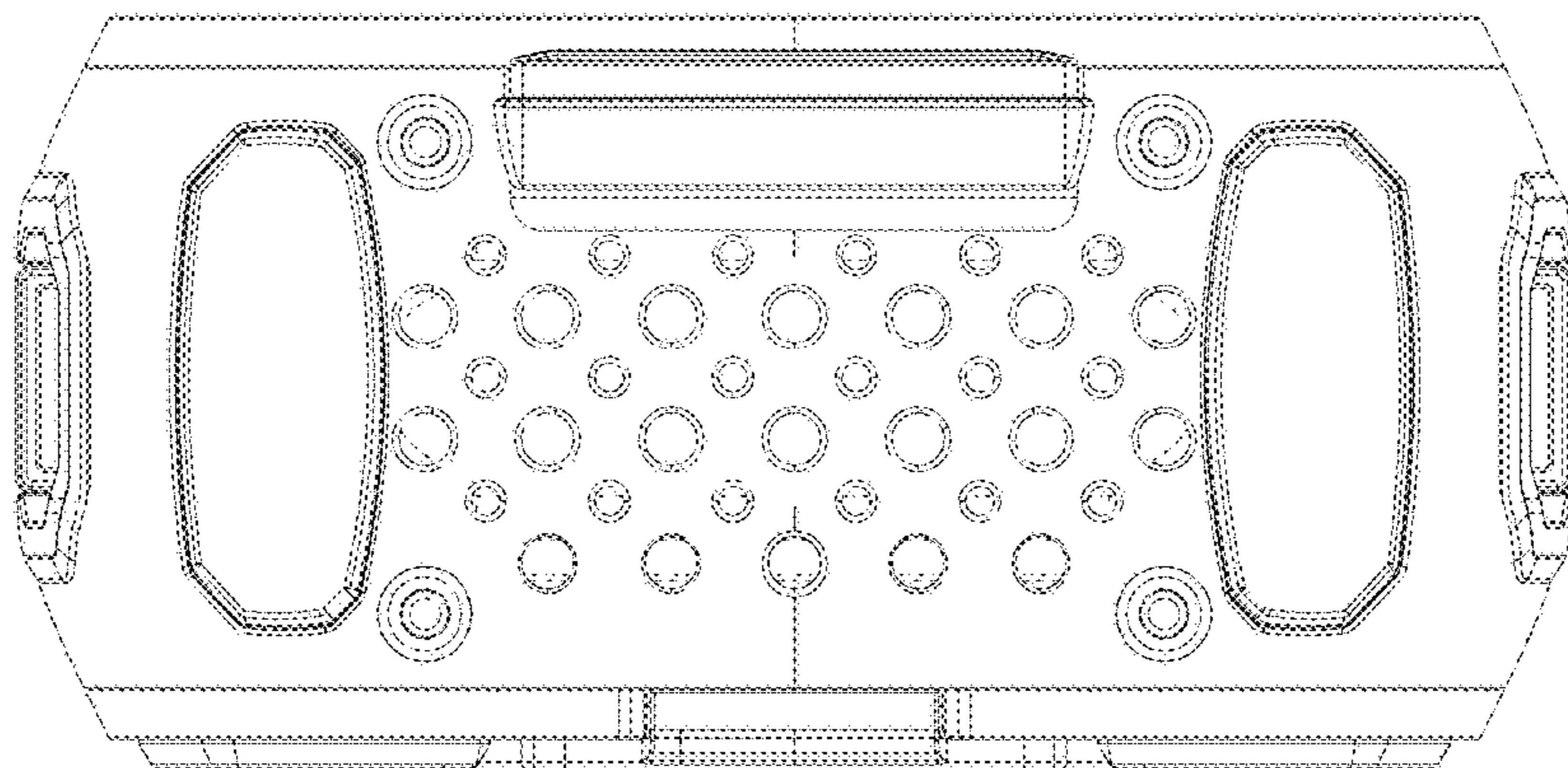

FIG. 8