



US00D843906S

(12) **United States Design Patent** (10) **Patent No.:** **US D843,906 S**  
**Guo** (45) **Date of Patent:** **\*\* \*Mar. 26, 2019**

(54) **AUTOMOBILE STEPPING BAR**

**DESCRIPTION**

(71) Applicant: **Fu Guo**, Vancouver (CA)  
(72) Inventor: **Yonghui Guo**, Taiyuan (CN)  
(\* ) Notice: This patent is subject to a terminal disclaimer.  
(\*\*) Term: **15 Years**  
(21) Appl. No.: **29/592,367**  
(22) Filed: **Jan. 30, 2017**  
(51) **LOC (11) Cl.** ..... **12-16**  
(52) **U.S. Cl.**  
USPC ..... **D12/203**  
(58) **Field of Classification Search**  
USPC ..... D12/203, 89, 98, 314, 162, 190, 196  
CPC .. B60R 3/002; B60R 3/02; B60R 3/00; B60R  
3/005; B60R 3/007  
See application file for complete search history.

(56) **References Cited**

**U.S. PATENT DOCUMENTS**

D330,536 S \* 10/1992 Holloway ..... D12/203  
D349,678 S \* 8/1994 Waddington ..... D12/203  
D349,679 S \* 8/1994 Waddington ..... D12/203  
D351,128 S \* 10/1994 Waddington ..... D12/203  
D436,336 S \* 1/2001 Sadr ..... D12/203  
6,536,790 B1 \* 3/2003 Ojanen ..... B60R 3/002  
280/163  
D473,178 S \* 4/2003 Schumacher ..... D12/203  
D488,759 S \* 4/2004 Hattori ..... D12/203

(Continued)

*Primary Examiner* — Michelle E. Wilson  
*Assistant Examiner* — Clese Moore, Jr.

(57) **CLAIM**

The ornamental design for an automobile stepping bar, as shown and described.

FIG. 1 is a perspective view of an automobile stepping bar showing the new design;  
FIG. 2 is an enlarged left side view thereof;  
FIG. 3 is an enlarged right side view thereof;  
FIG. 4 is a top plan view thereof;  
FIG. 5 is a front elevation view thereof;  
FIG. 6 is a bottom plan view thereof; and  
FIG. 7 is a rear elevation view thereof.  
FIG. 8 is a perspective view of an embodiment of an automobile stepping bar showing the new design;  
FIG. 9 is an enlarged left side view thereof;  
FIG. 10 is an enlarged right side view thereof;  
FIG. 11 is a top plan view thereof;  
FIG. 12 is a front elevation view thereof;  
FIG. 13 is a bottom plan view thereof; and  
FIG. 14 is a rear elevation view thereof.  
FIG. 15 is a perspective view of an automobile stepping bar showing the new design wherein the longitudinal length of the automobile stepping bar is variable;  
FIG. 16 is an enlarged left side view thereof;  
FIG. 17 is an enlarged right side view thereof;  
FIG. 18 is a top plan view thereof;  
FIG. 19 is a front elevation view thereof;  
FIG. 20 is a bottom plan view thereof; and  
FIG. 21 is a rear elevation view thereof.  
FIG. 22 is a perspective view of an embodiment of an automobile stepping bar showing the new design wherein the longitudinal length of the automobile stepping bar is variable;  
FIG. 23 is an enlarged left side view thereof;  
FIG. 24 is an enlarged right side view thereof;  
FIG. 25 is a top plan view thereof;  
FIG. 26 is a front elevation view thereof;  
FIG. 27 is a bottom plan view thereof; and  
FIG. 28 is a rear elevation view thereof.  
The automobile stepping bar is shown with a symbolic break in its length. The appearance of any portion of the article between the break lines forms no part of the claimed design.

**1 Claim, 28 Drawing Sheets**

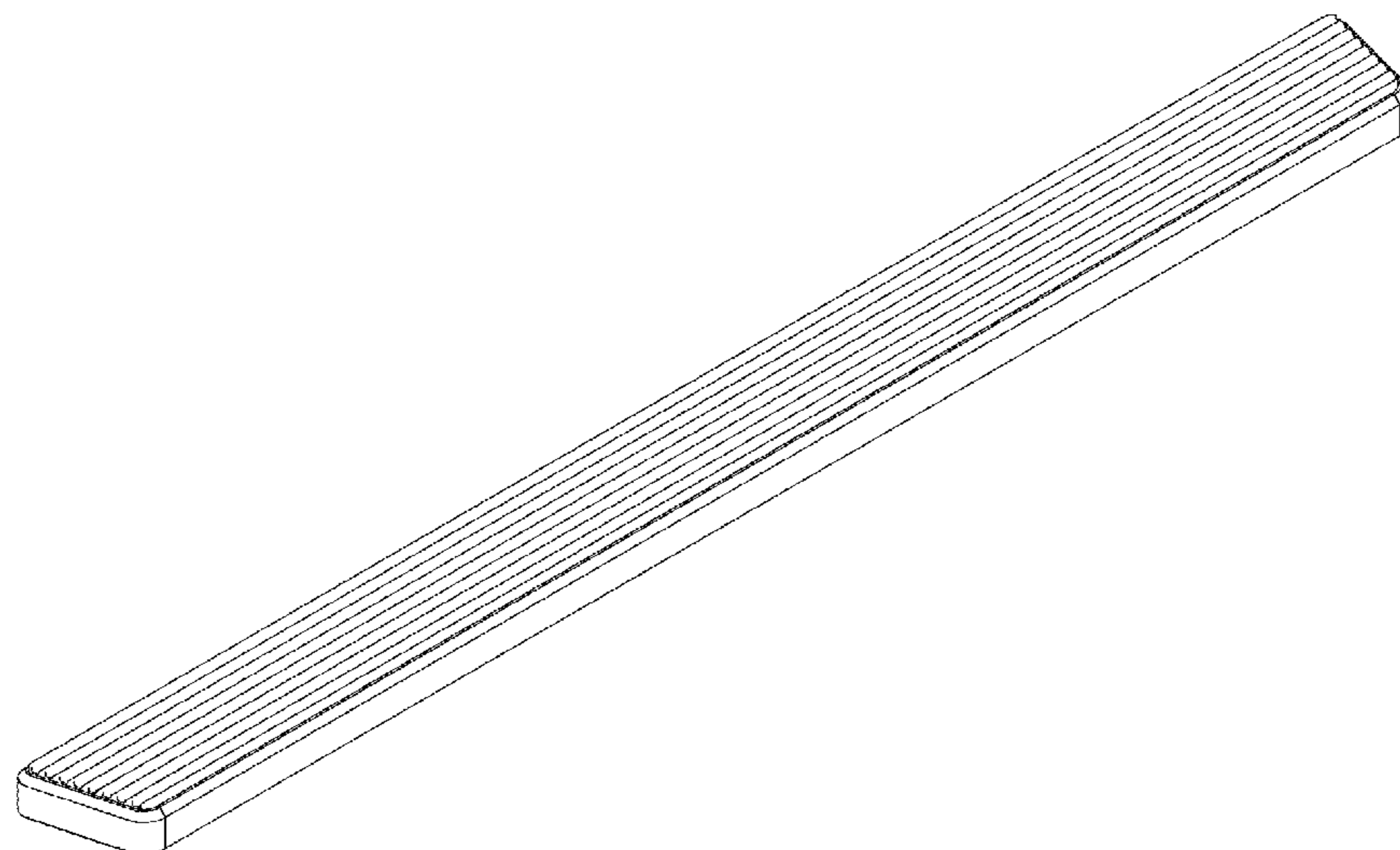

(56)

**References Cited**

U.S. PATENT DOCUMENTS

|              |    |   |         |               |       |                      |
|--------------|----|---|---------|---------------|-------|----------------------|
| D496,898     | S  | * | 10/2004 | Metros        | ..... | D12/203              |
| D497,338     | S  | * | 10/2004 | Metros        | ..... | D12/203              |
| D513,725     | S  | * | 1/2006  | Metros        | ..... | D12/203              |
| D514,492     | S  | * | 2/2006  | Metros        | ..... | D12/203              |
| D535,928     | S  | * | 1/2007  | Crandall      | ..... | D12/203              |
| D546,259     | S  | * | 7/2007  | Metros        | ..... | D12/203              |
| D559,755     | S  | * | 1/2008  | Ito           | ..... | D12/203              |
| D568,221     | S  | * | 5/2008  | Cord          | ..... | D12/203              |
| D588,514     | S  | * | 3/2009  | Kudelko       | ..... | D12/203              |
| D595,630     | S  | * | 7/2009  | McPherson     | ..... | D12/203              |
| D596,097     | S  | * | 7/2009  | Huang-Tsai    | ..... | D12/203              |
| D596,098     | S  | * | 7/2009  | Huang-Tsai    | ..... | D12/203              |
| D632,627     | S  | * | 2/2011  | Huang-Tsai    | ..... | D12/203              |
| D714,703     | S  | * | 10/2014 | Masanek, Jr.  | ..... | B60D 1/36<br>D12/203 |
| D788,669     | S  | * | 6/2017  | Guo           | ..... | D12/203              |
| D813,135     | S  | * | 3/2018  | Baeza         | ..... | D12/203              |
| D817,838     | S  | * | 5/2018  | Dionisopoulos | ..... | D12/203              |
| 2011/0266766 | A1 | * | 11/2011 | Huang-Tsai    | ..... | B60R 3/00<br>280/169 |

\* cited by examiner

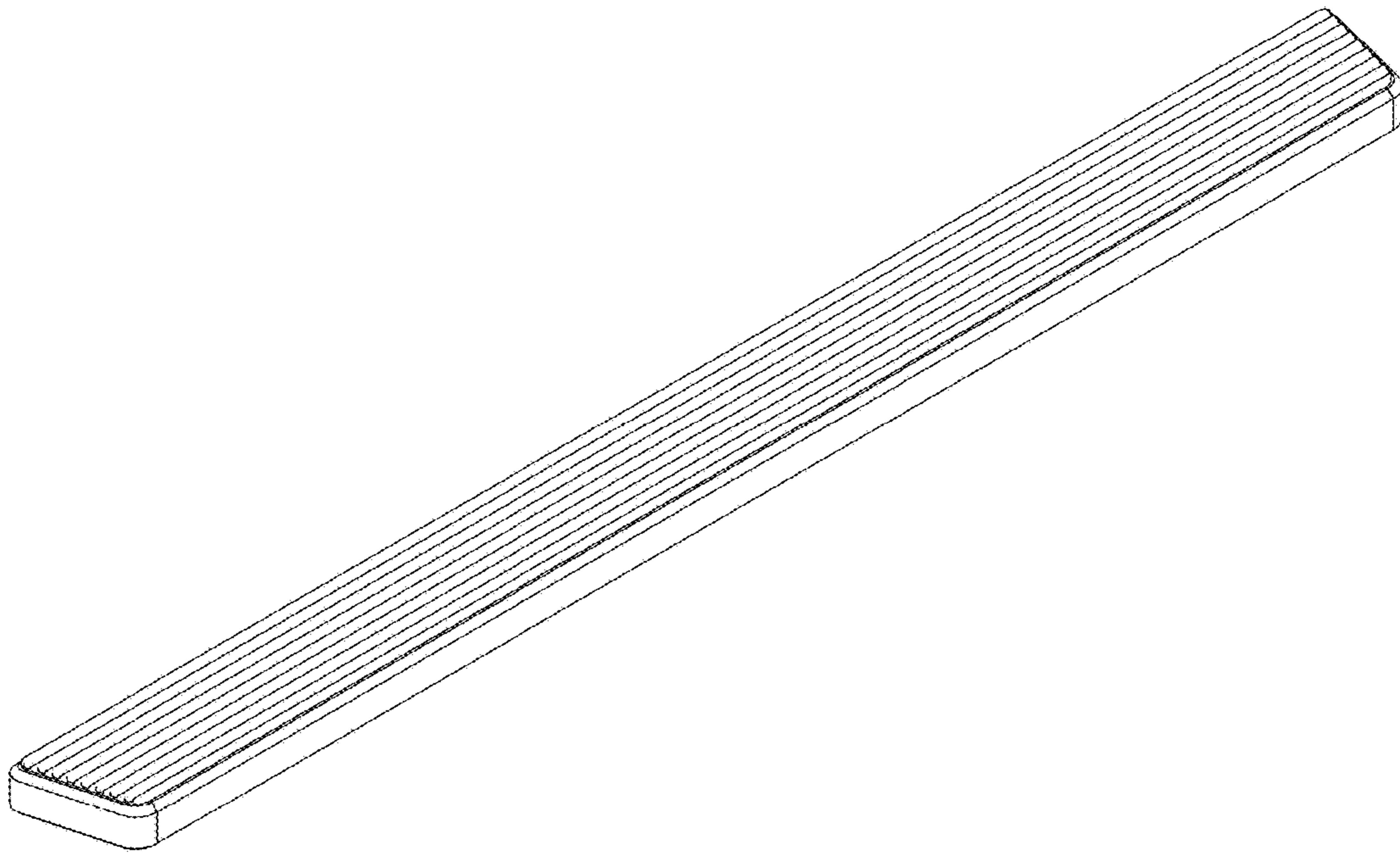

FIG. 1

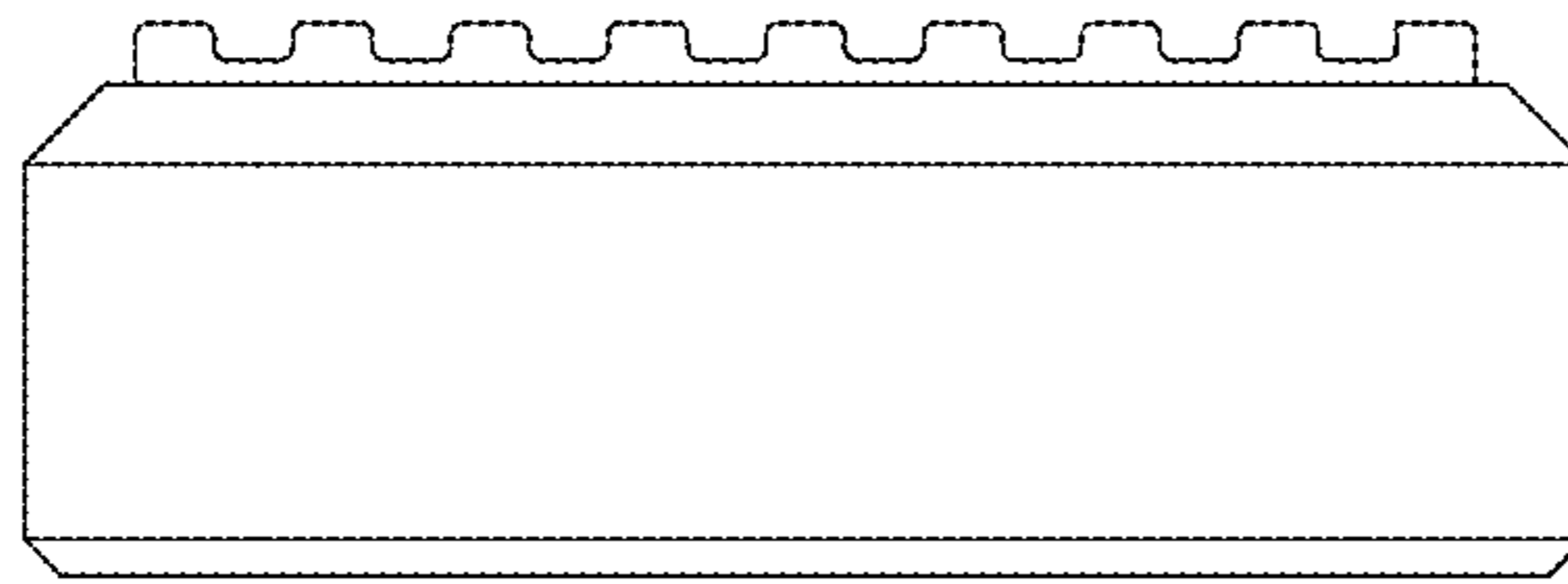

FIG. 2

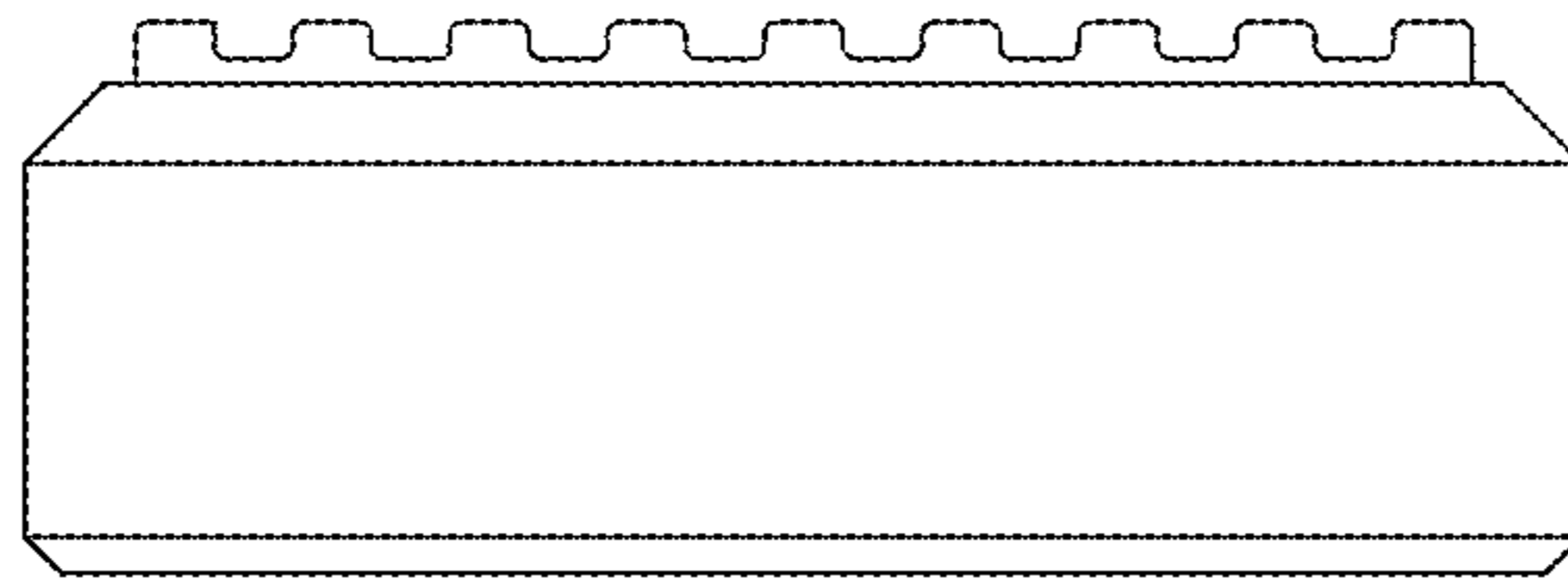

FIG. 3

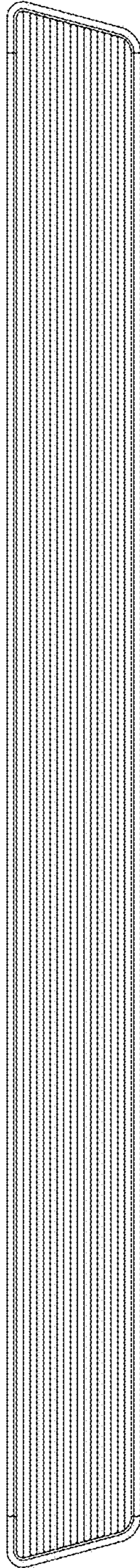

FIG. 4

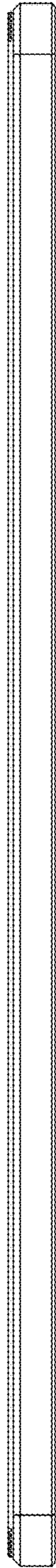

FIG. 5

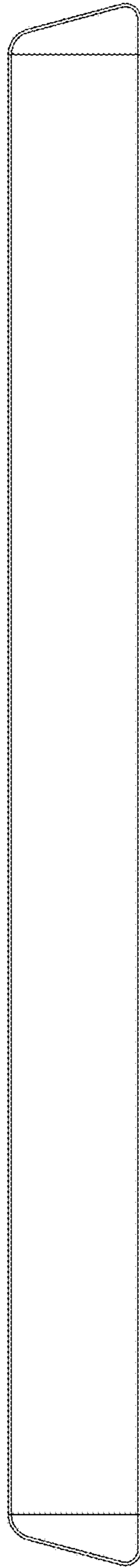

FIG. 6



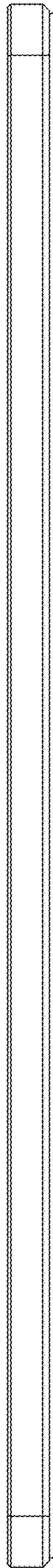

FIG. 7

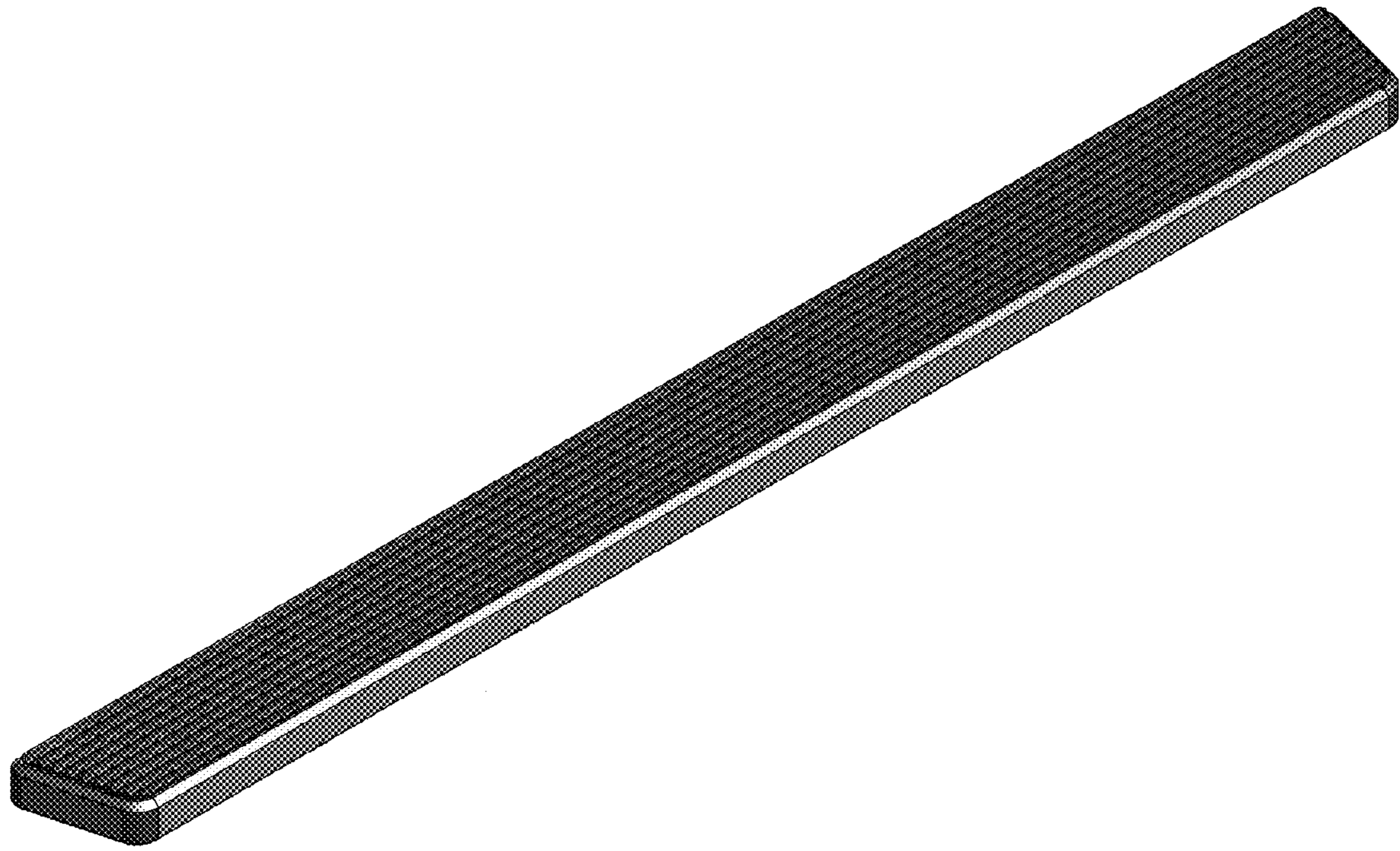

FIG. 8

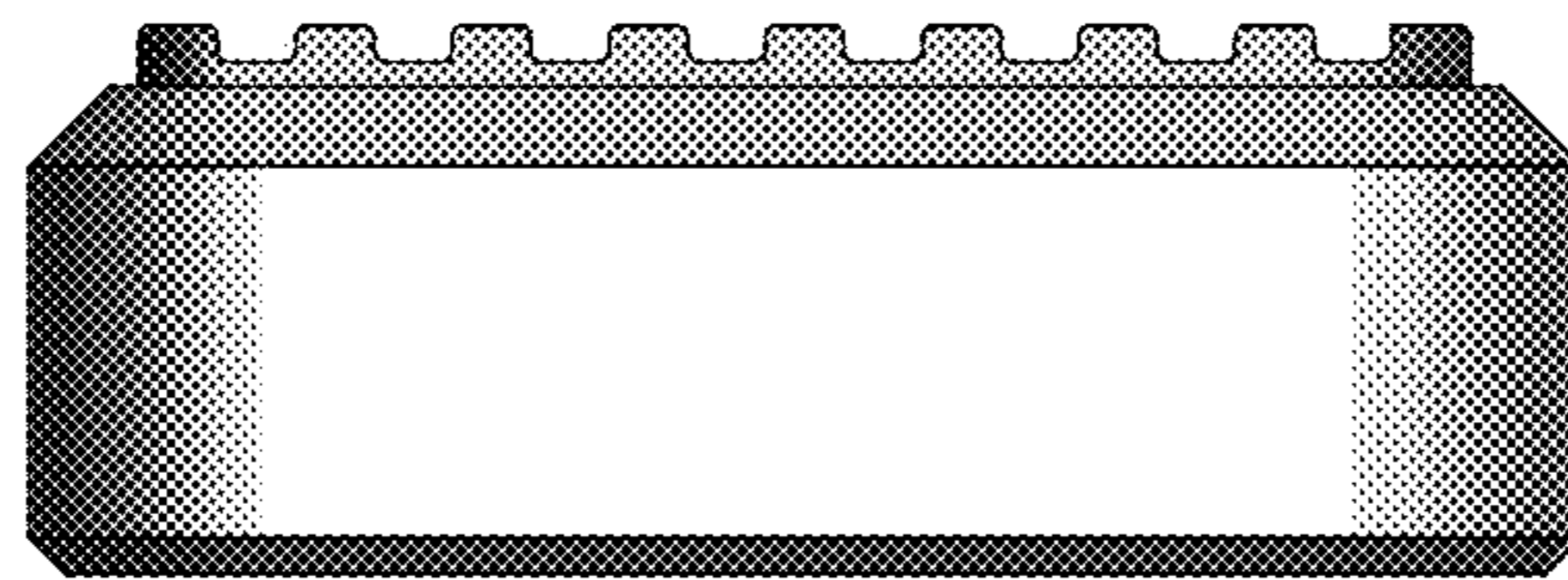

FIG. 9

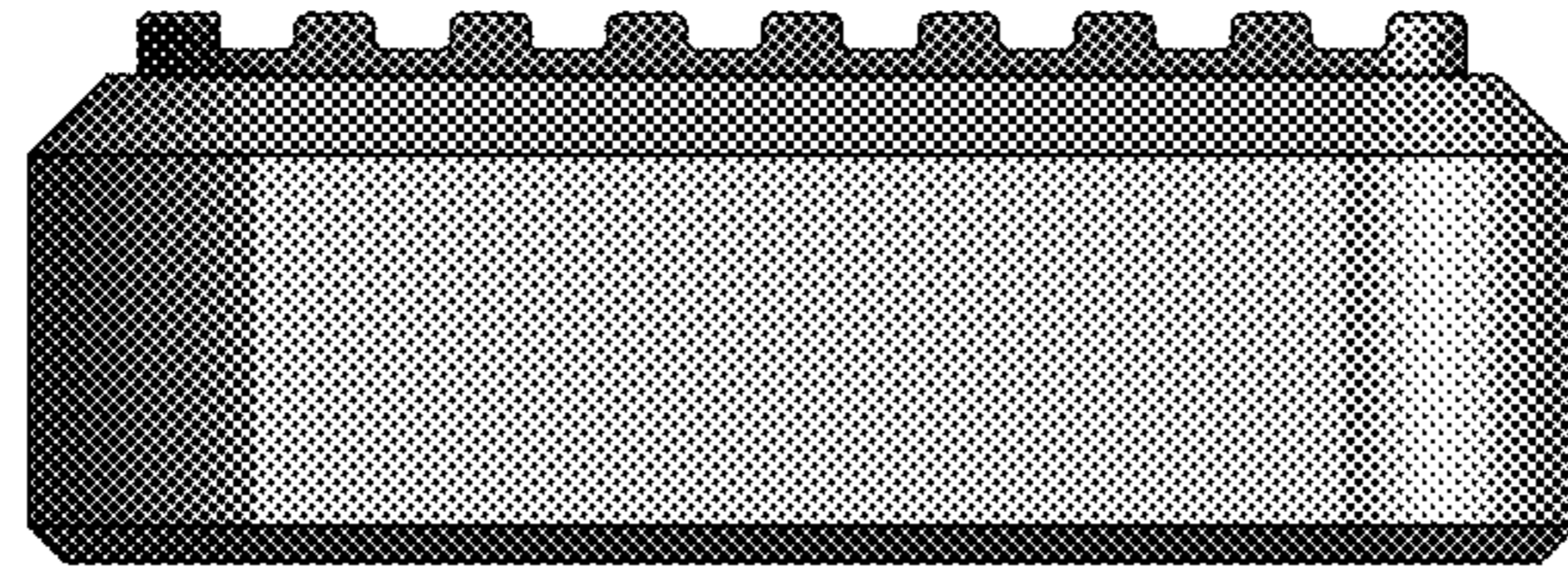

FIG. 10

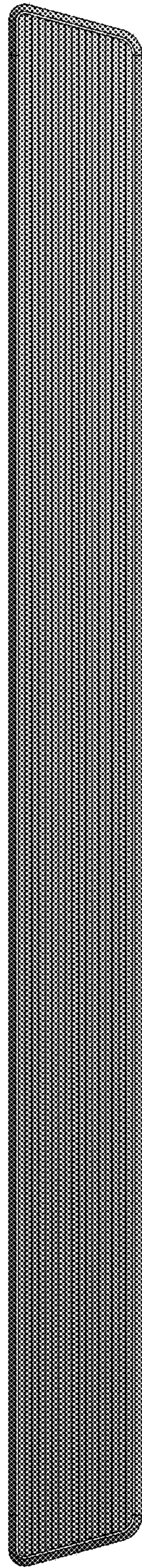

FIG. 11

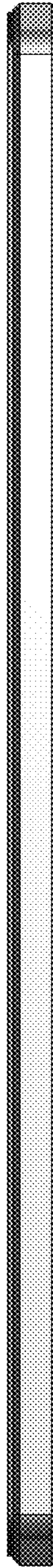

FIG. 12

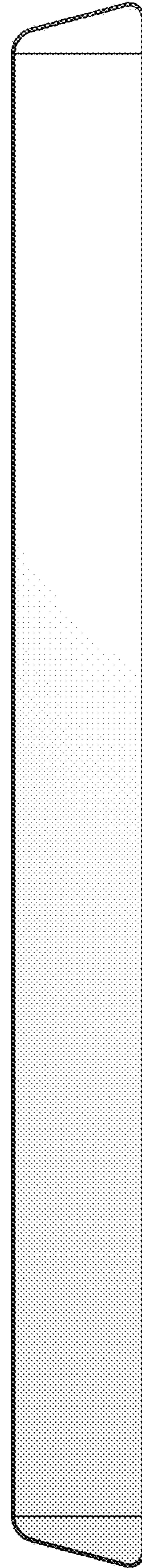

FIG. 13

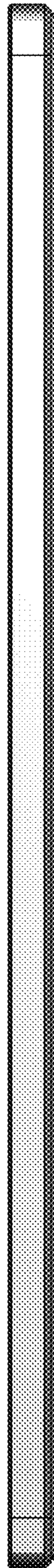

FIG. 14



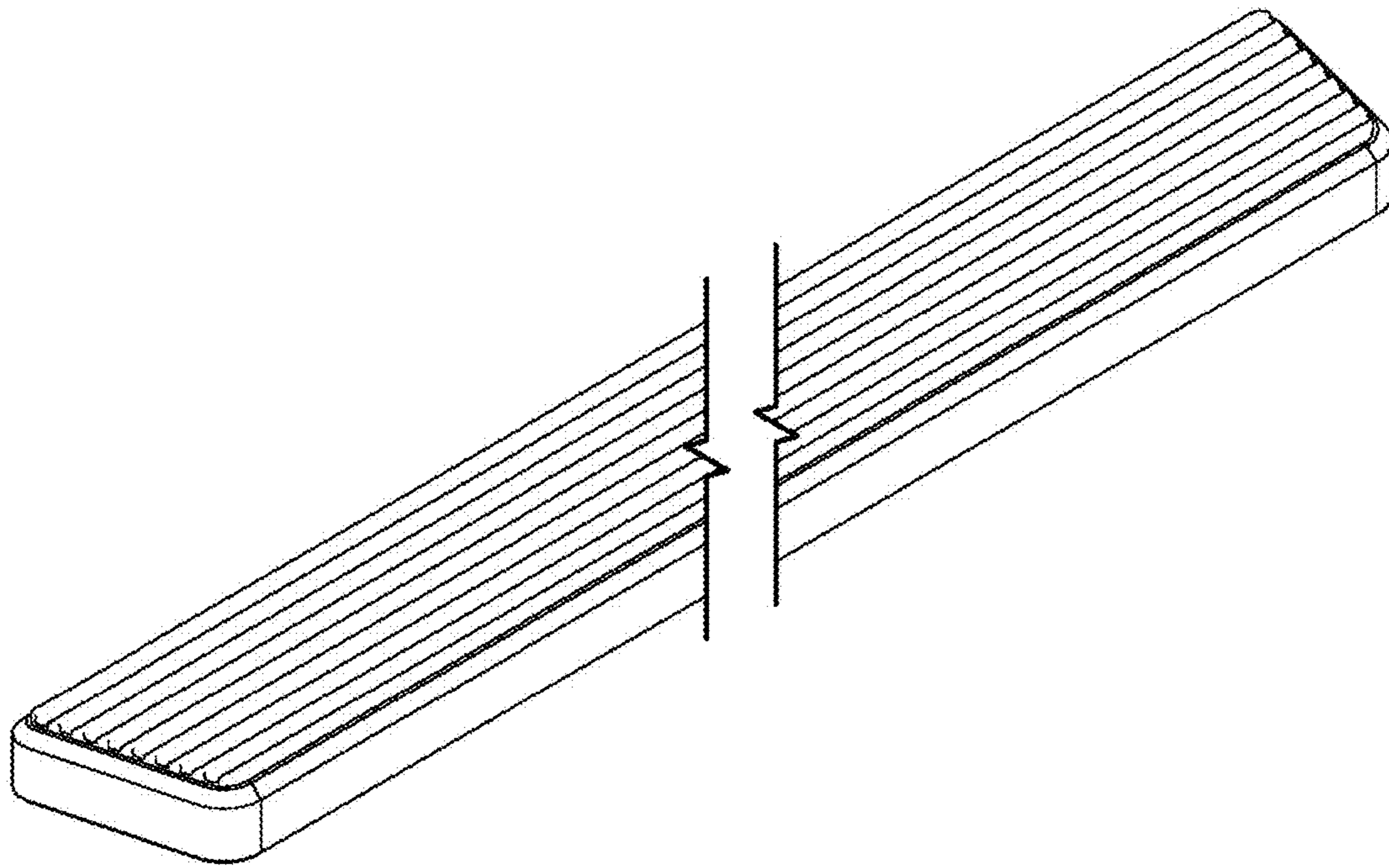

FIG. 15

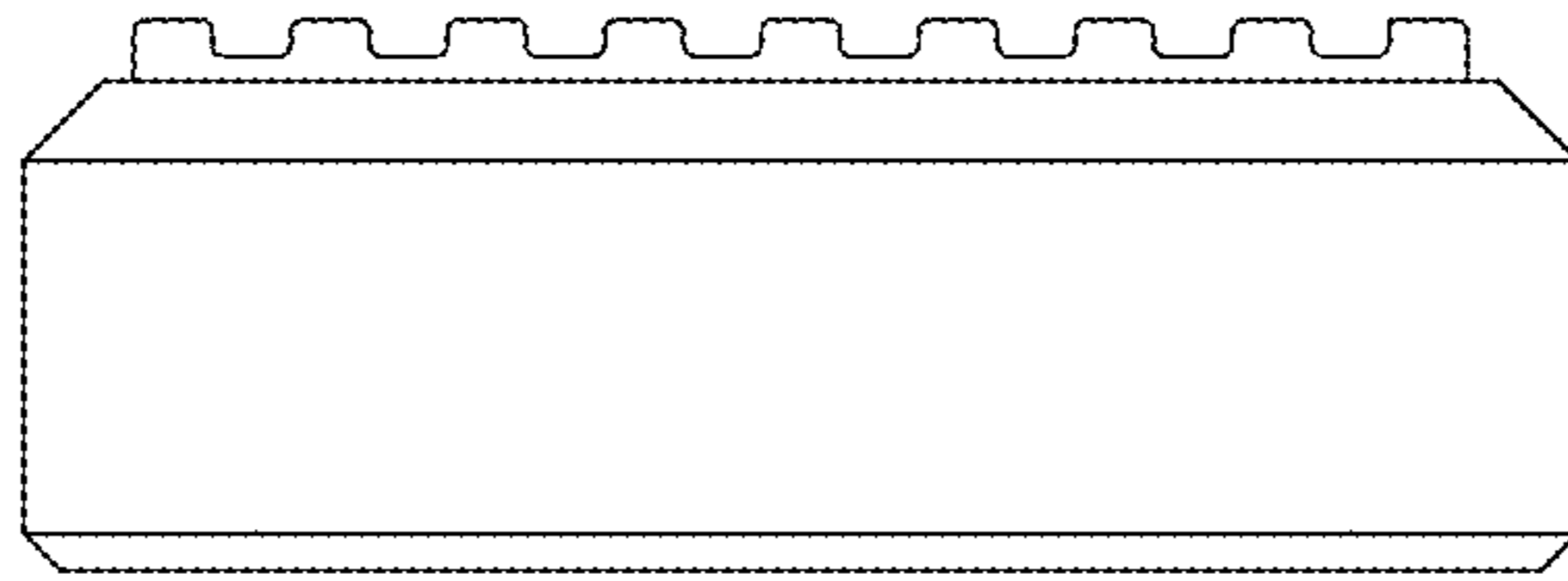

FIG. 16

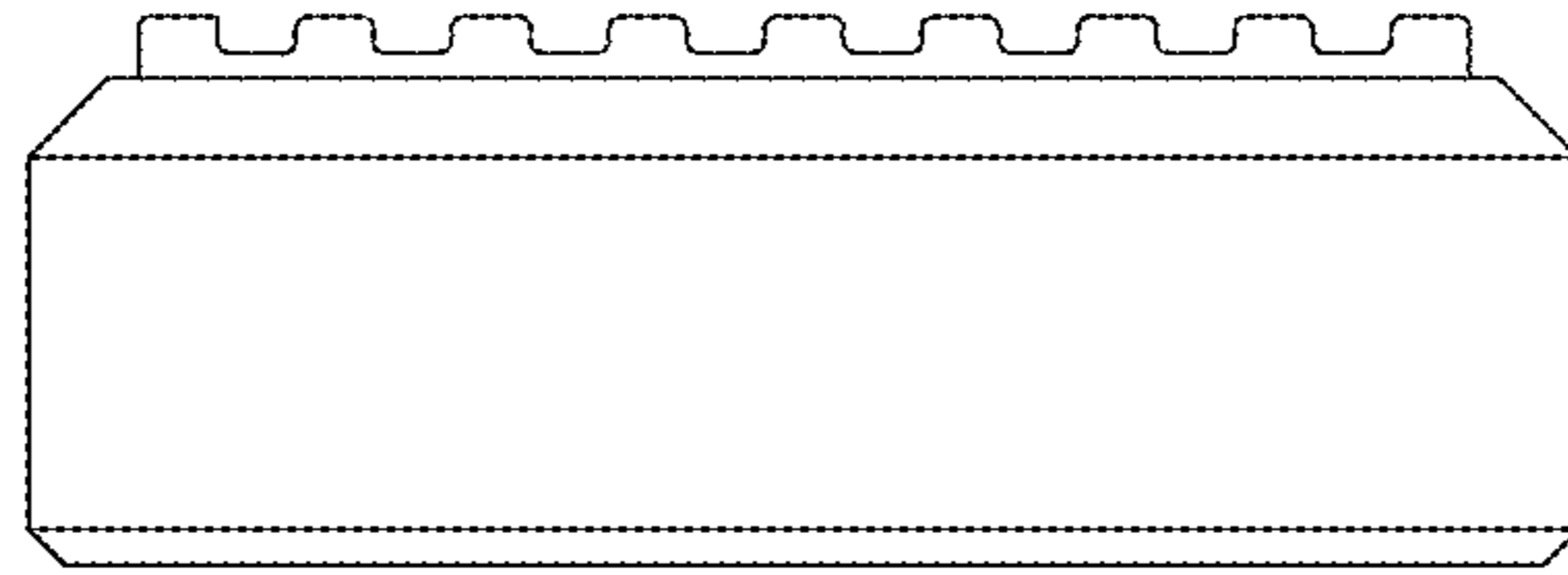

FIG. 17

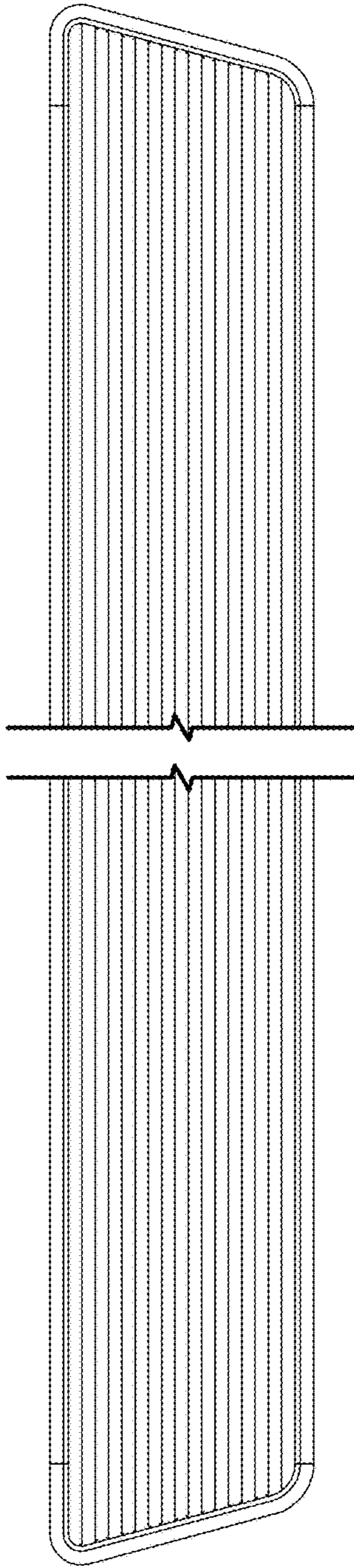

FIG. 18

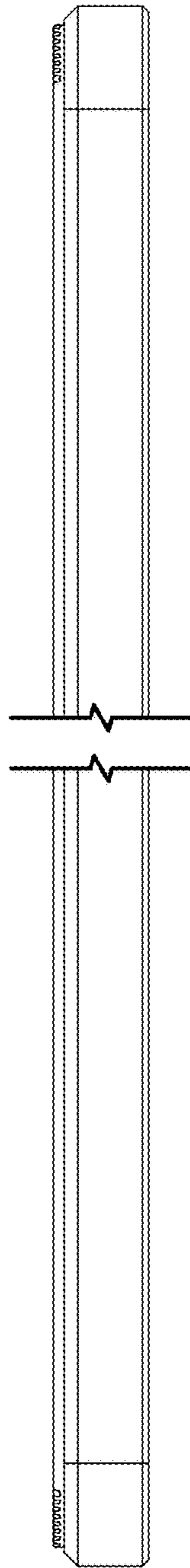

FIG. 19

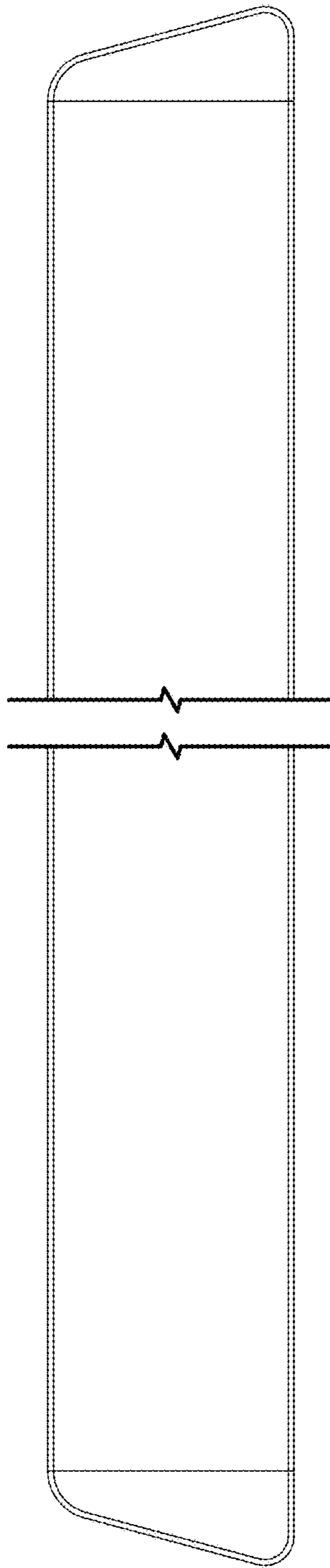

FIG. 20

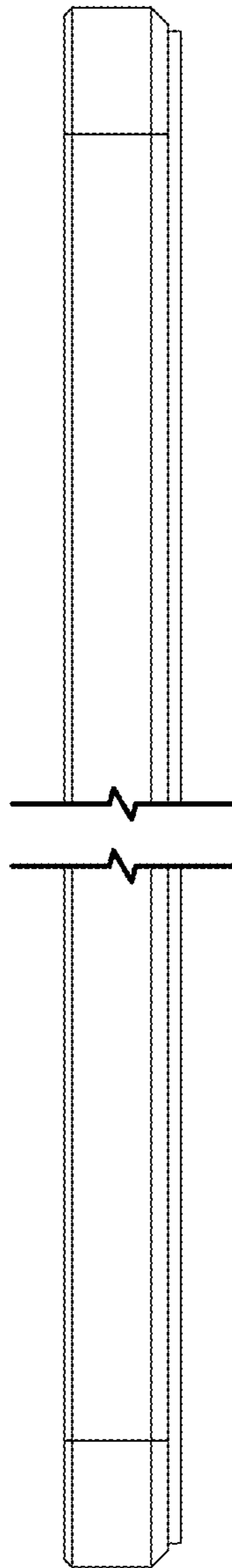

FIG. 21

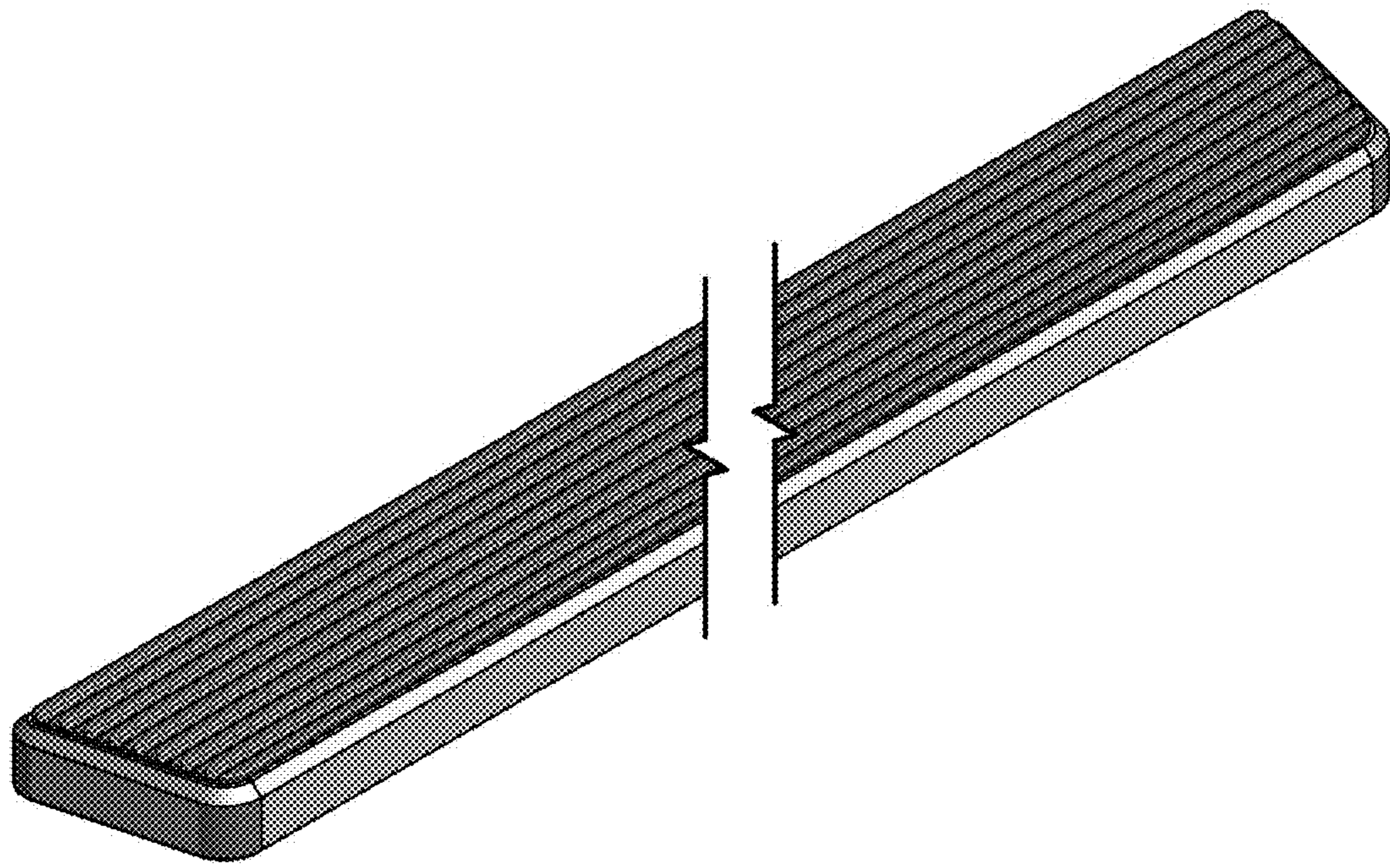

FIG. 22



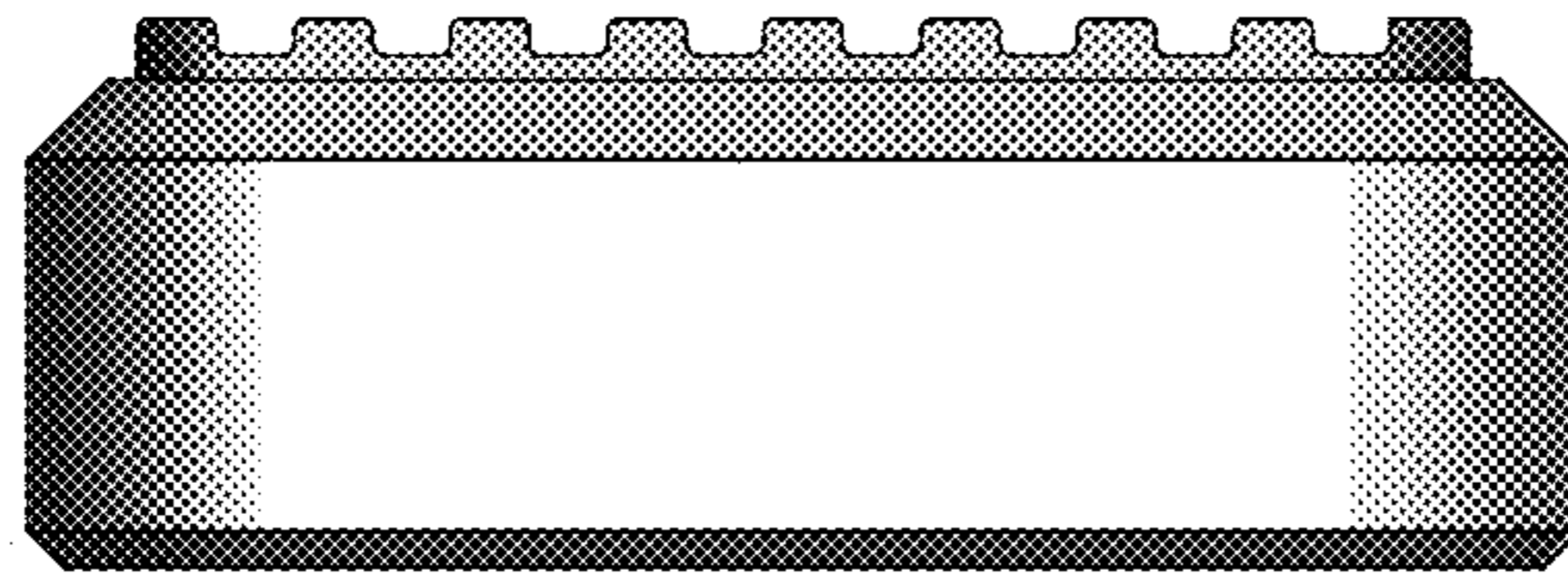

FIG. 23

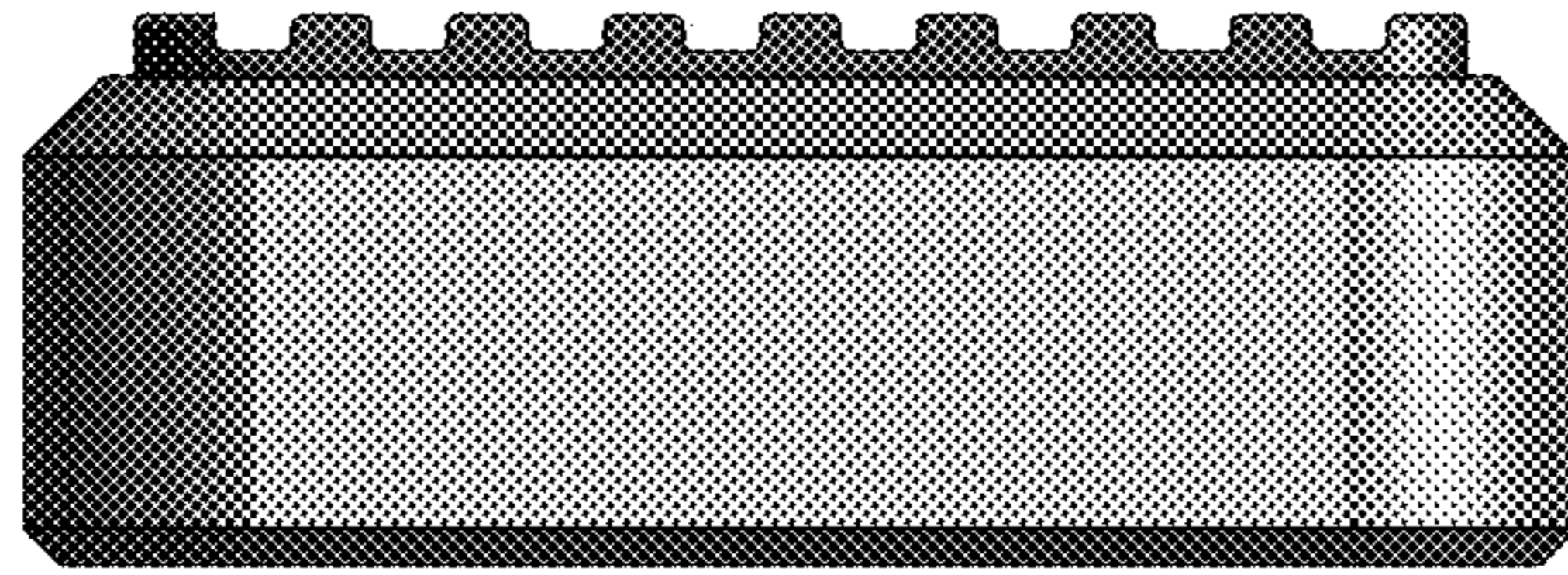

FIG. 24

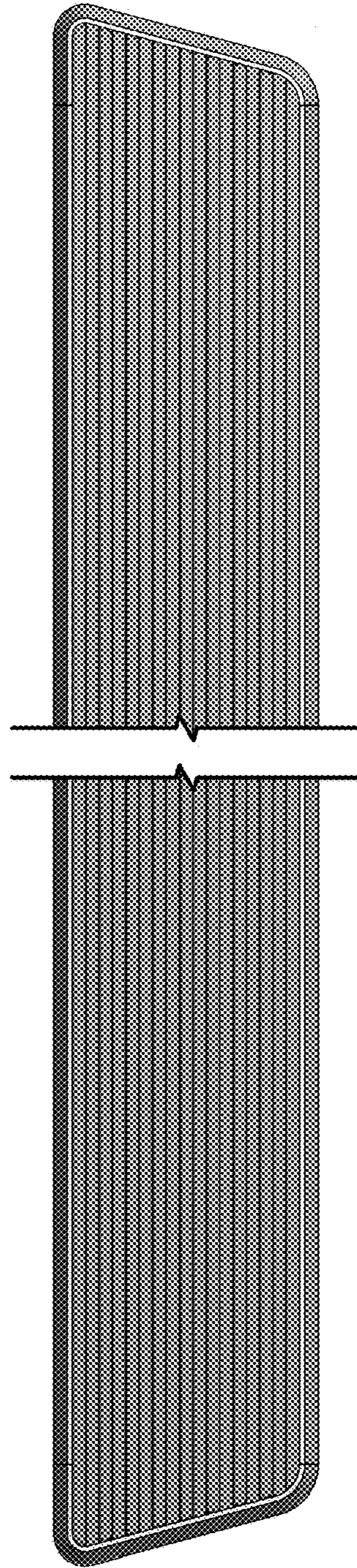

FIG. 25

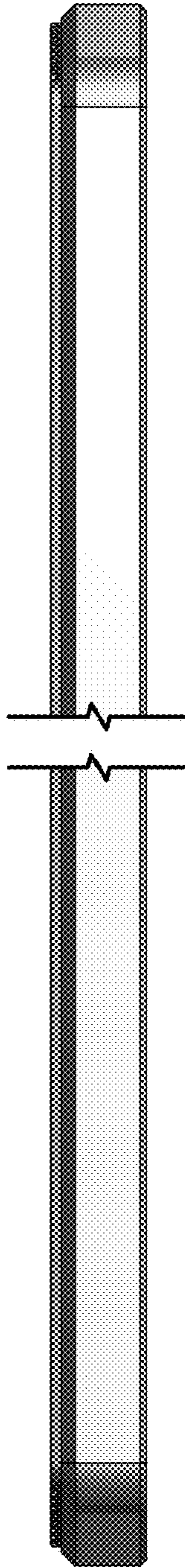

FIG. 26

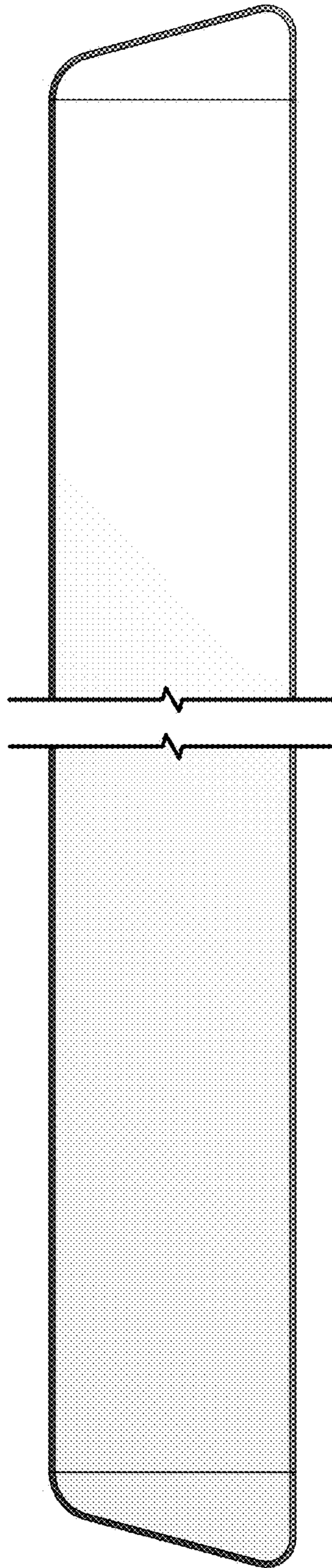

FIG. 27

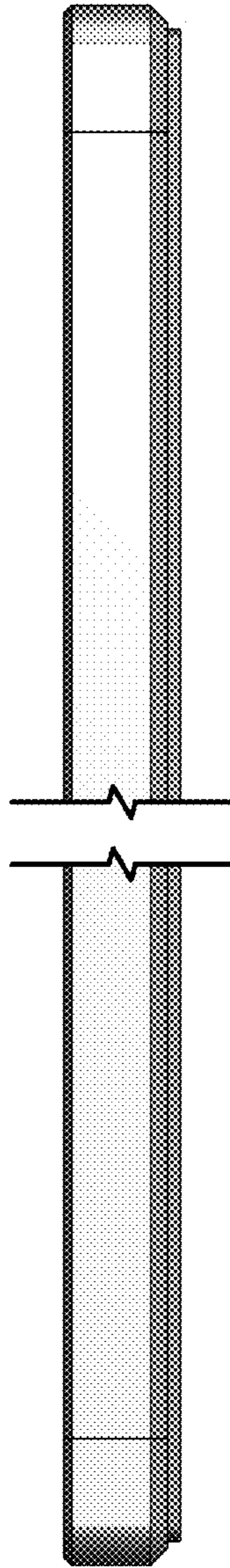

FIG. 28