



US00D843905S

(12) **United States Design Patent** (10) **Patent No.:** **US D843,905 S**
Guo (45) **Date of Patent:** **** *Mar. 26, 2019**

(54) **AUTOMOBILE STEPPING BAR**

(71) Applicant: **Fu Guo**, Vancouver (CA)

(72) Inventor: **Yonghui Guo**, Taiyuan (CN)

(*) Notice: This patent is subject to a terminal disclaimer.

(**) Term: **15 Years**

(21) Appl. No.: **29/592,355**

(22) Filed: **Jan. 30, 2017**

(51) **LOC (11) Cl.** **12-16**

(52) **U.S. Cl.**
USPC **D12/203**

(58) **Field of Classification Search**
USPC D12/203, 89, 98, 314, 162, 190, 196
CPC .. B60R 3/002; B60R 3/02; B60R 3/00; B60R 3/005; B60R 3/007
See application file for complete search history.

(56) **References Cited**

U.S. PATENT DOCUMENTS

D330,536 S *	10/1992	Holloway	D12/203
D349,678 S *	8/1994	Waddington	D12/203
D351,128 S *	10/1994	Waddington	D12/203
D436,336 S *	1/2001	Sadr	D12/203
6,536,790 B1 *	3/2003	Ojanen	B60R 3/002 280/163
D473,178 S *	4/2003	Schumacher	D12/203
D488,759 S *	4/2004	Hattori	D12/203
D496,898 S *	10/2004	Metros	D12/203

(Continued)

Primary Examiner — Michelle E. Wilson

Assistant Examiner — Clese Moore, Jr.

(57) **CLAIM**

The ornamental design for an automobile stepping bar, as shown and described.

DESCRIPTION

FIG. 1 is a perspective view of an automobile stepping bar showing the new design;

FIG. 2 is an enlarged left side view thereof;
 FIG. 3 is an enlarged right side view thereof;
 FIG. 4 is a top plan view thereof;
 FIG. 5 is a front elevation view thereof;
 FIG. 6 is a bottom plan view thereof; and
 FIG. 7 is a rear elevation view thereof.
 FIG. 8 is a perspective view of an embodiment of an automobile stepping bar showing the new design;
 FIG. 9 is an enlarged left side view thereof;
 FIG. 10 is an enlarged right side view thereof;
 FIG. 11 is a top plan view thereof;
 FIG. 12 is a front elevation view thereof;
 FIG. 13 is a bottom plan view thereof; and
 FIG. 14 is a rear elevation view thereof.
 FIG. 15 is a perspective view of an automobile stepping bar showing the new design wherein the longitudinal length of the automobile stepping bar is variable;
 FIG. 16 is an enlarged left side view thereof;
 FIG. 17 is an enlarged right side view thereof;
 FIG. 18 is a top plan view thereof;
 FIG. 19 is a front elevation view thereof;
 FIG. 20 is a bottom plan view thereof; and
 FIG. 21 is a rear elevation view thereof.
 FIG. 22 is a perspective view of an embodiment of an automobile stepping bar showing the new design wherein the longitudinal length of the automobile stepping bar is variable;
 FIG. 23 is an enlarged left side view thereof;
 FIG. 24 is an enlarged right side view thereof;
 FIG. 25 is a top plan view thereof;
 FIG. 26 is a front elevation view thereof;
 FIG. 27 is a bottom plan view thereof; and,
 FIG. 28 is a rear elevation view thereof.
 The automobile stepping bar is shown with a symbolic break in its length. The appearance of any portion of the article between the break lines forms no part of the claimed design.

1 Claim, 28 Drawing Sheets

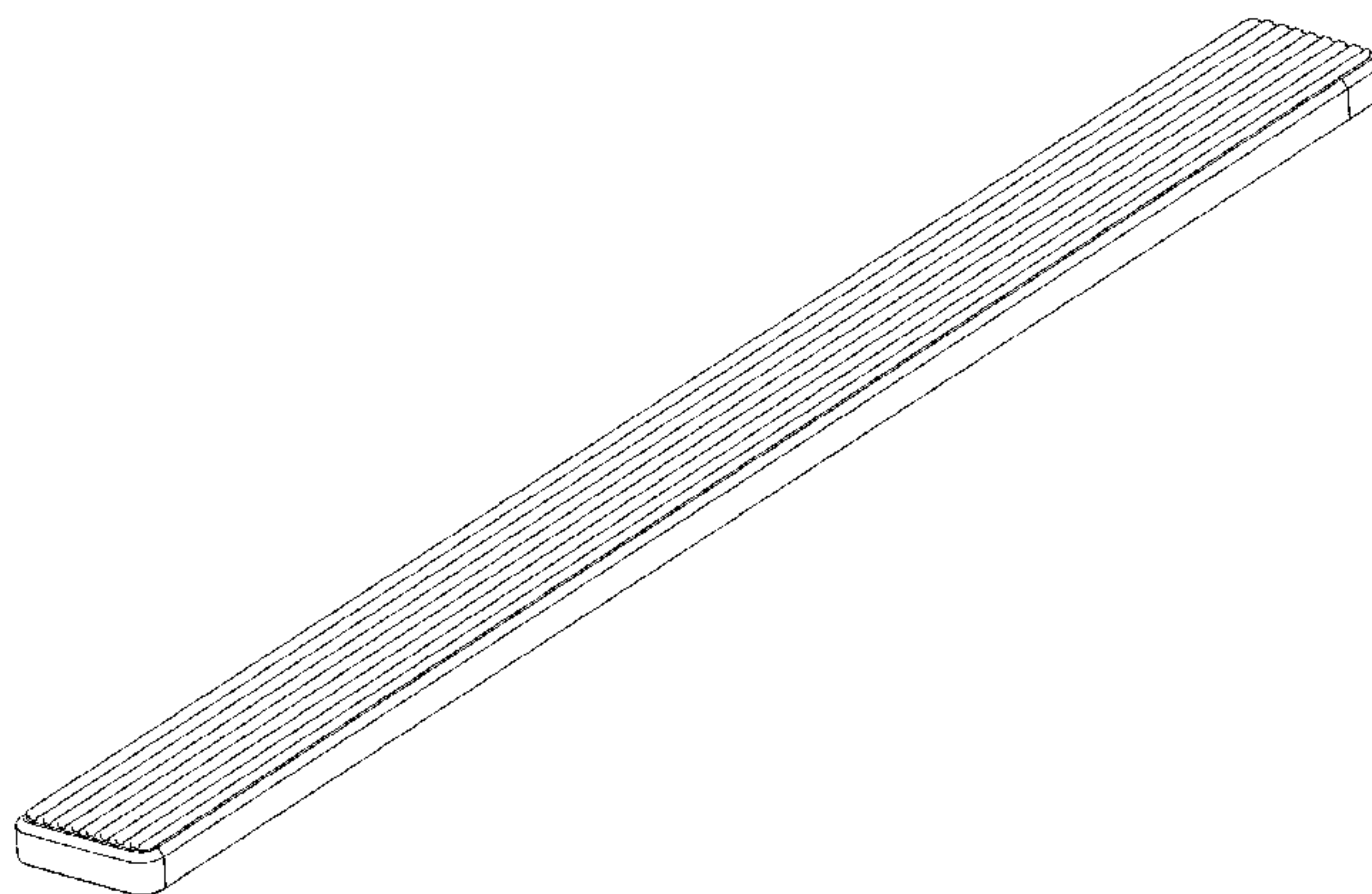

(56)

References Cited

U.S. PATENT DOCUMENTS

D497,338	S *	10/2004	Metros	D12/203
D513,725	S *	1/2006	Metros	D12/203
D514,492	S *	2/2006	Metros	D12/203
D535,928	S *	1/2007	Crandall	D12/203
D546,259	S *	7/2007	Metros	D12/203
D559,755	S *	1/2008	Ito	D12/203
D568,221	S *	5/2008	Cord	D12/203
D588,514	S *	3/2009	Kudelko	D12/203
D595,630	S *	7/2009	McPherson	D12/203
D596,097	S *	7/2009	Huang-Tsai	D12/203
D596,098	S *	7/2009	Huang-Tsai	D12/203
D632,627	S *	2/2011	Huang-Tsai	D12/203
D714,703	S *	10/2014	Masaneck, Jr.	B60D 1/36 D12/203
D788,669	S *	6/2017	Guo	D12/203
D813,135	S *	3/2018	Baeza	D12/203
D817,838	S *	5/2018	Dionisopoulos	D12/203
2011/0266766	A1 *	11/2011	Huang-Tsai	B60R 3/00 280/169

* cited by examiner

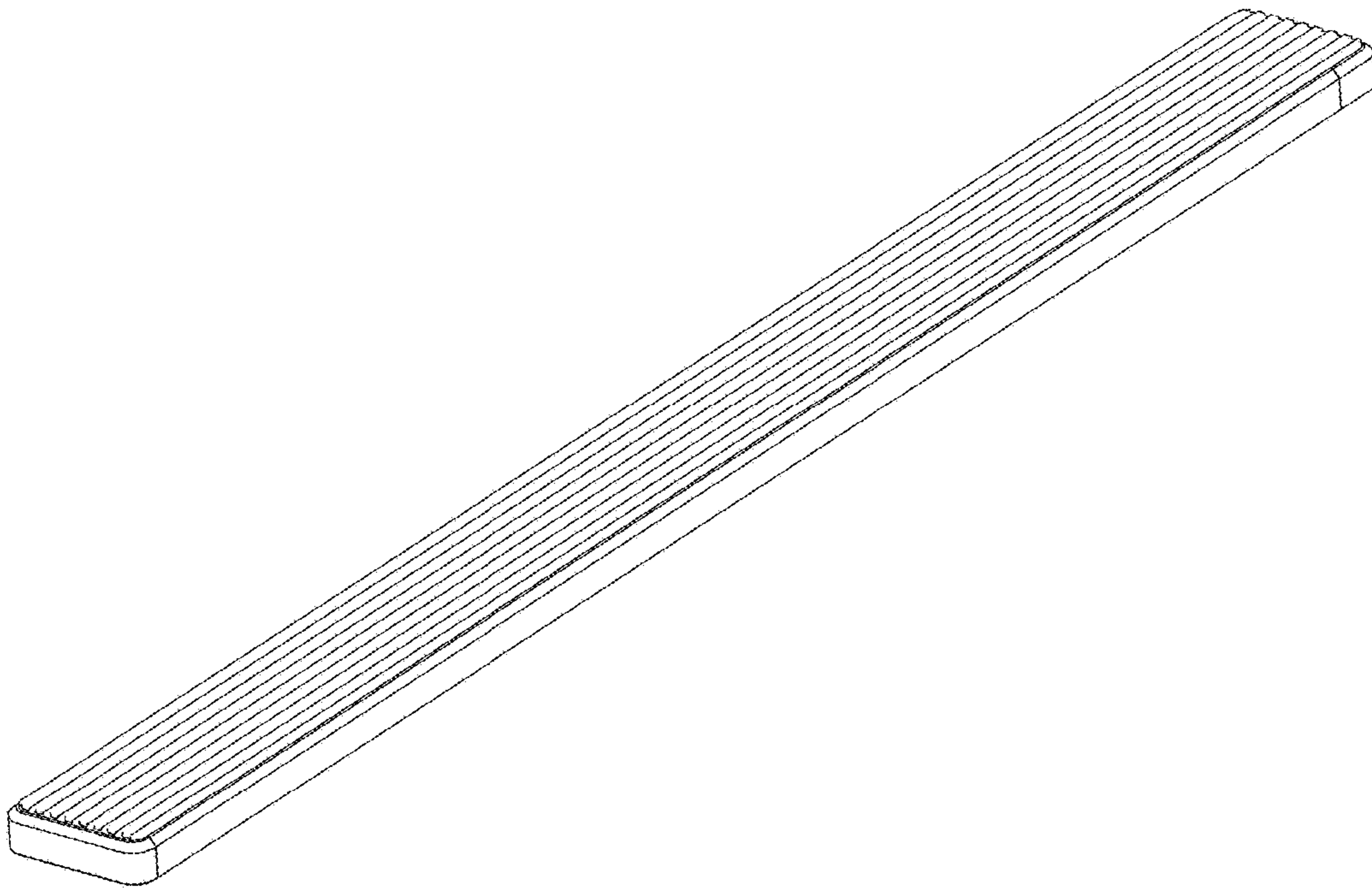

FIG. 1

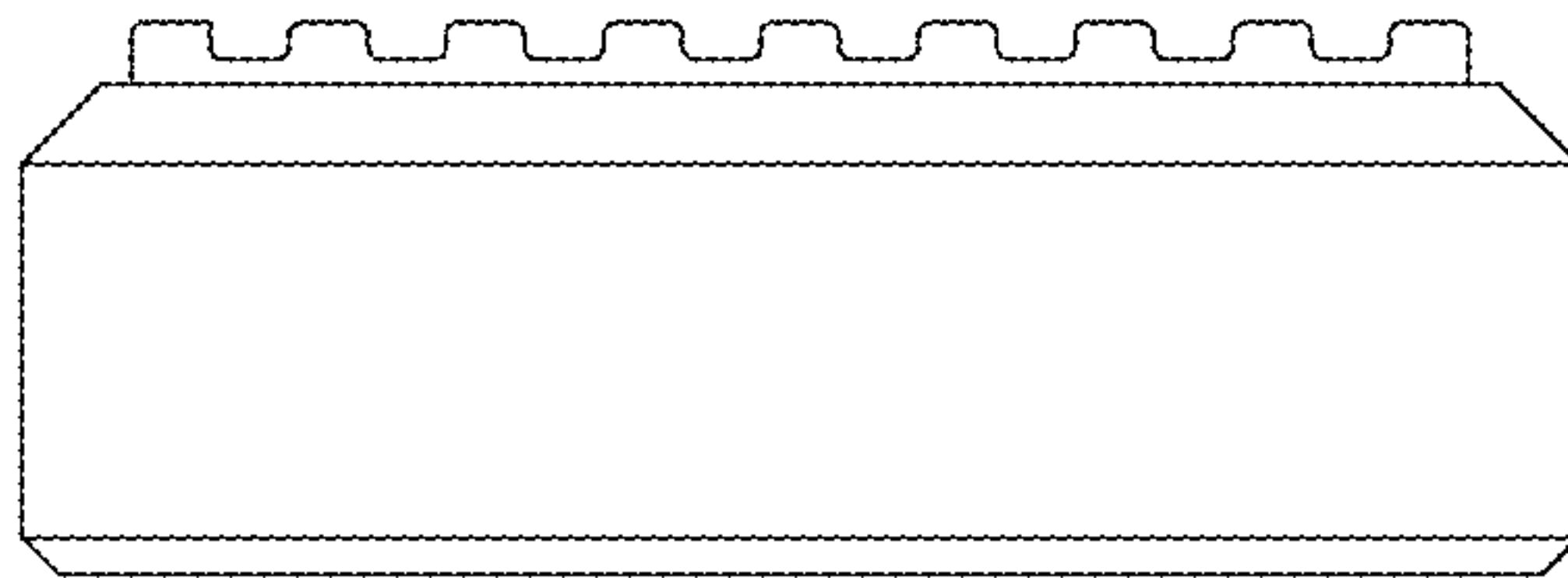

FIG. 2

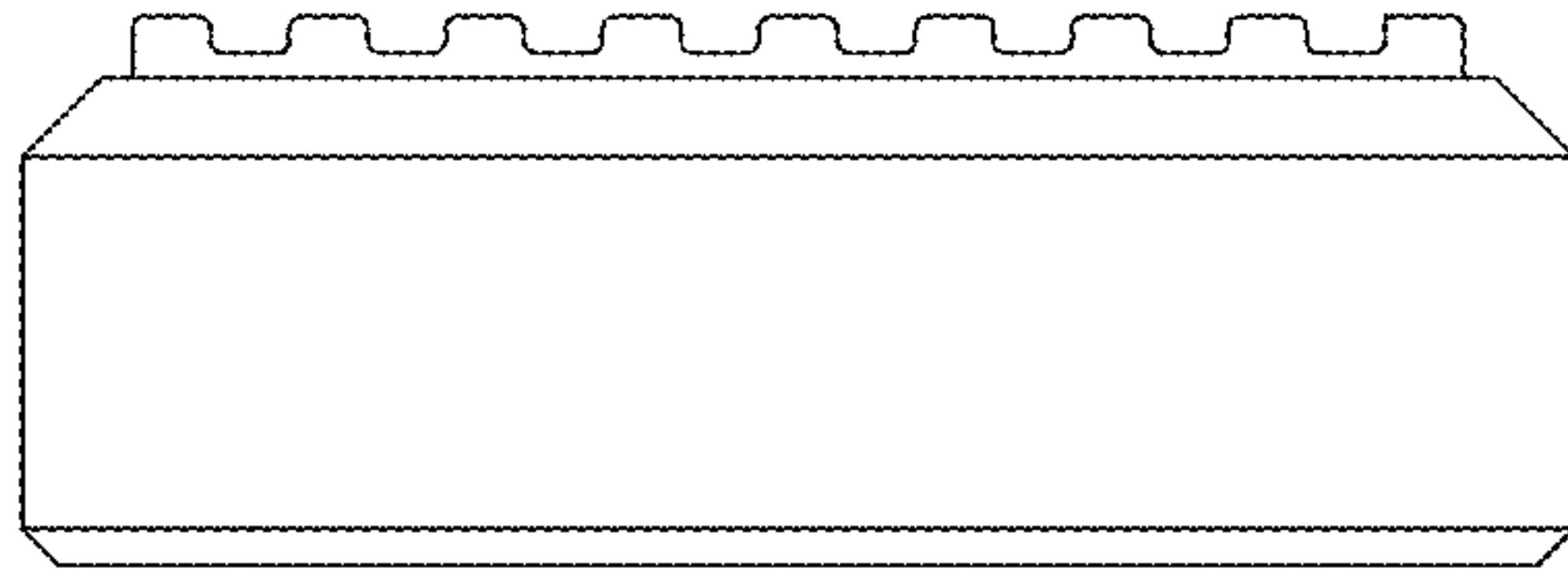

FIG. 3

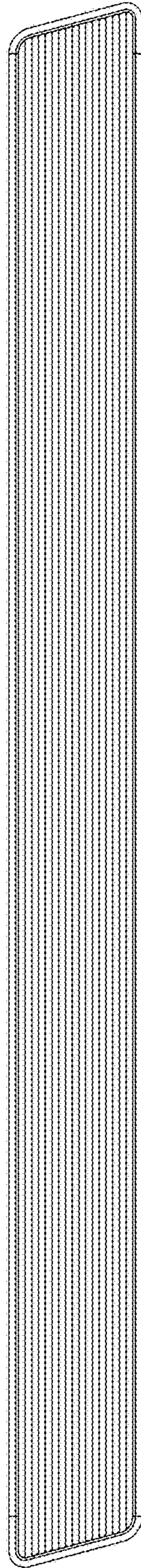

FIG. 4



FIG. 5

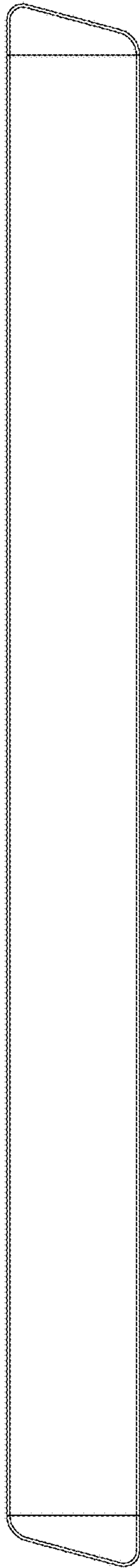

FIG. 6

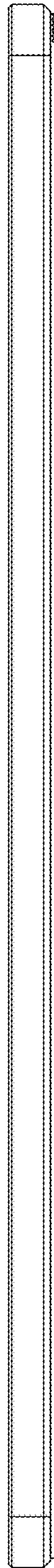

FIG. 7

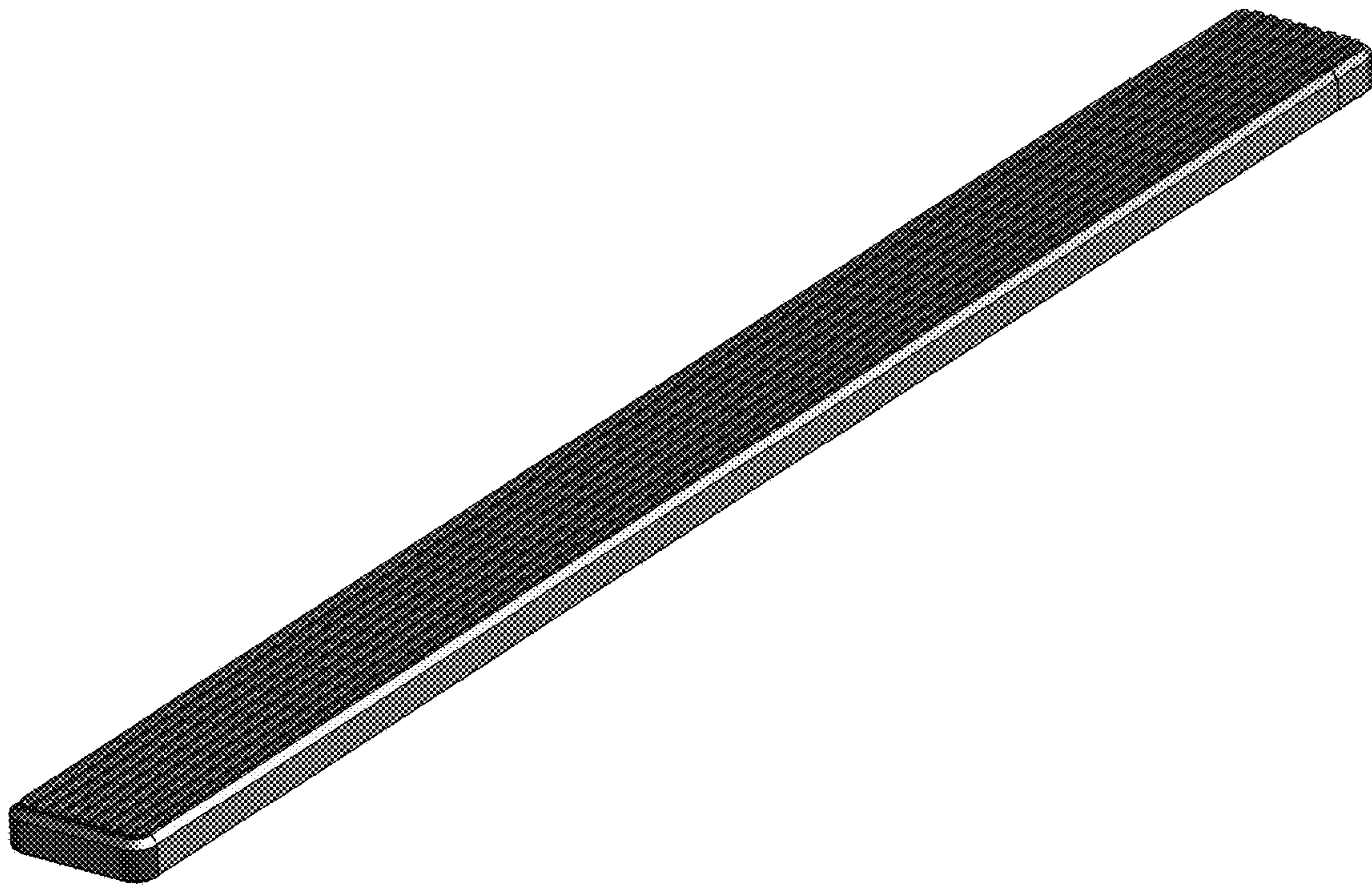

FIG. 8

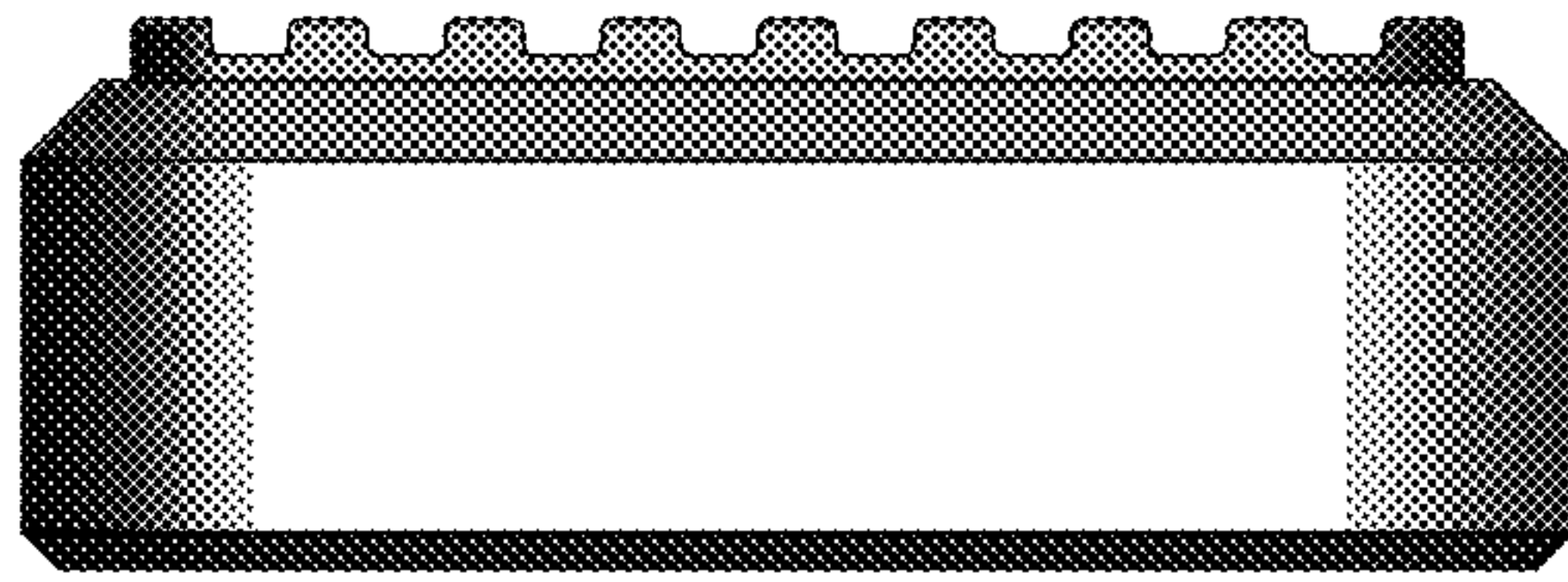

FIG. 9

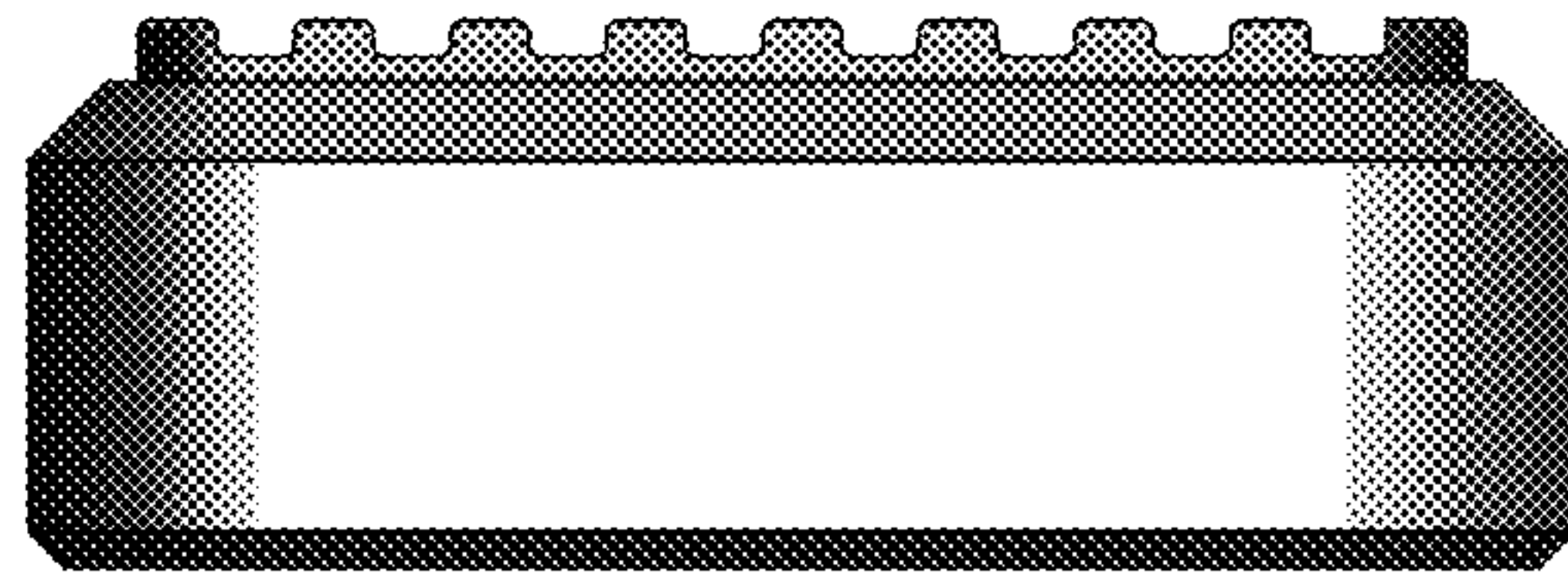

FIG. 10

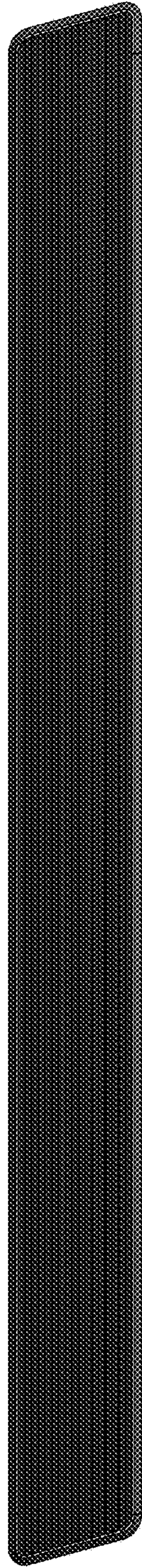

FIG. 11

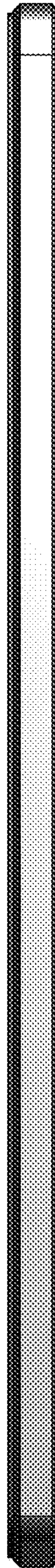

FIG. 12

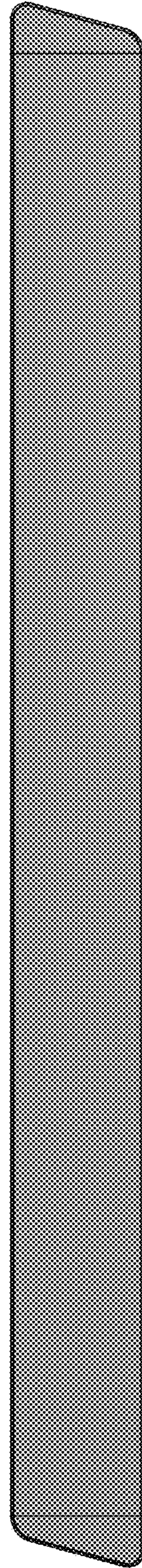

FIG. 13

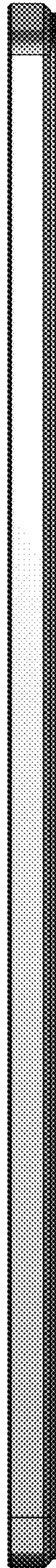

FIG. 14

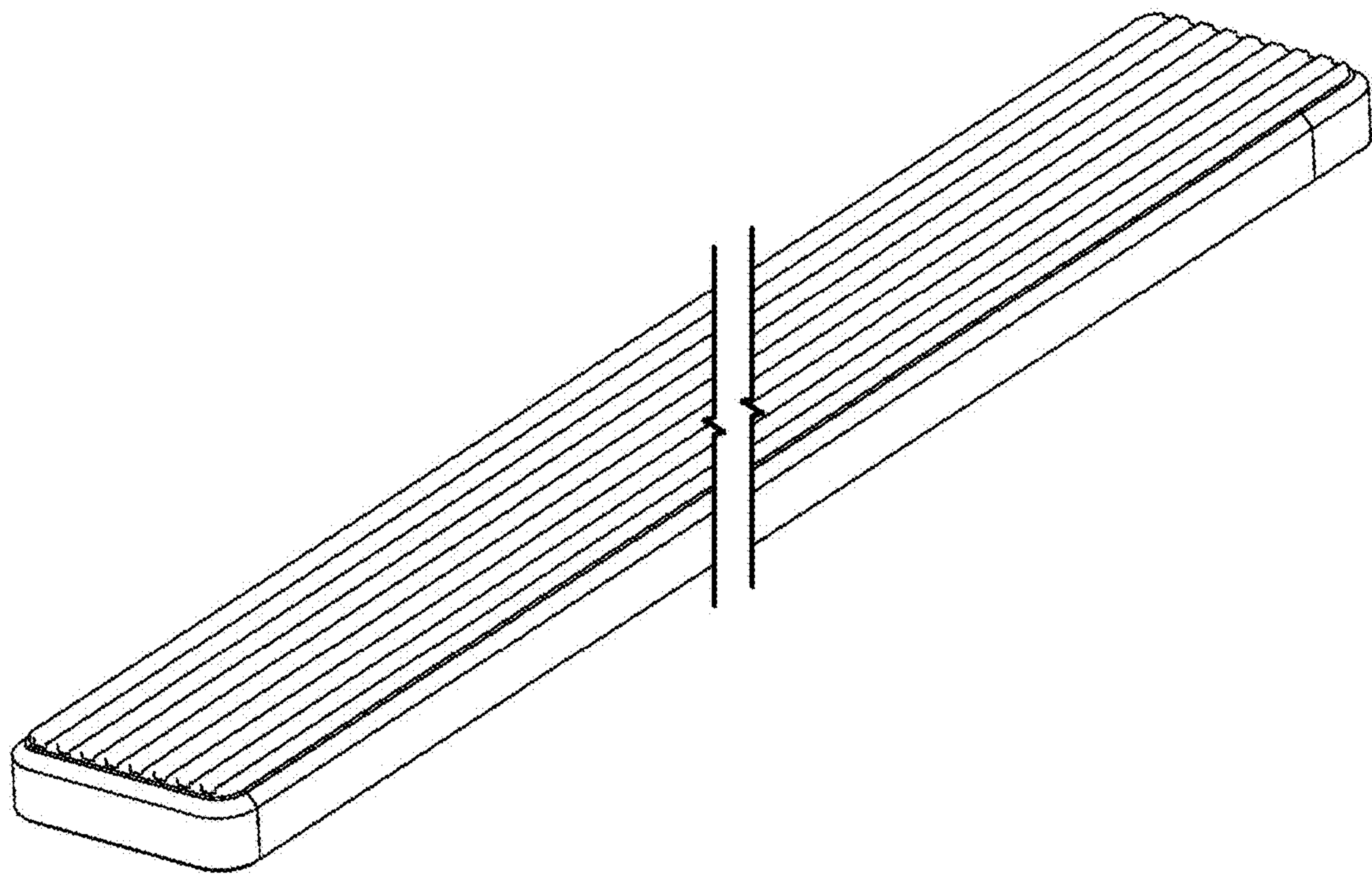

FIG. 15

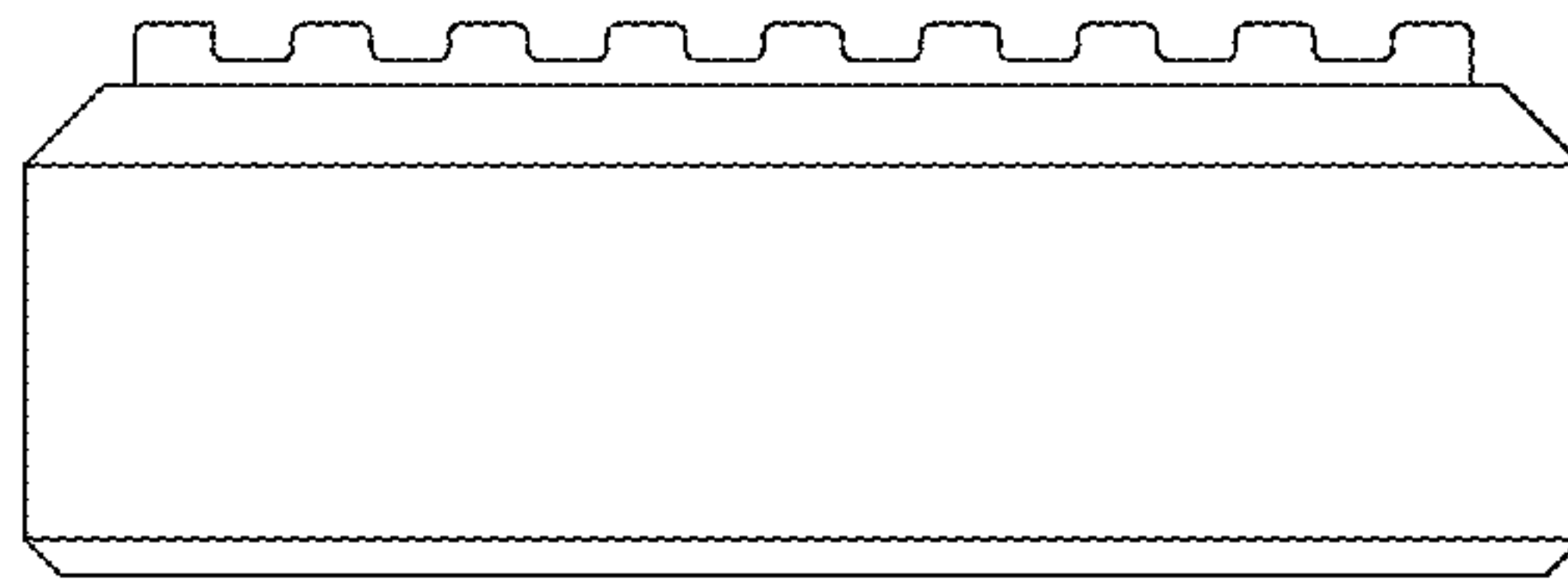

FIG. 16

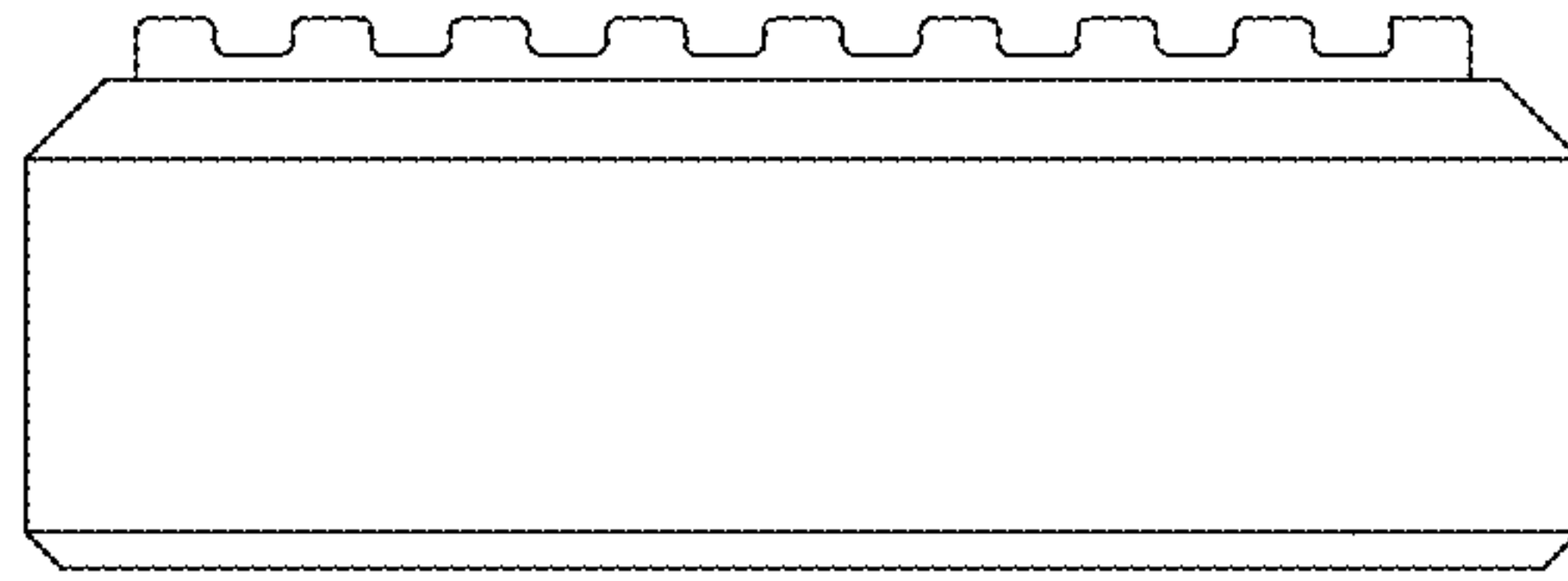

FIG. 17

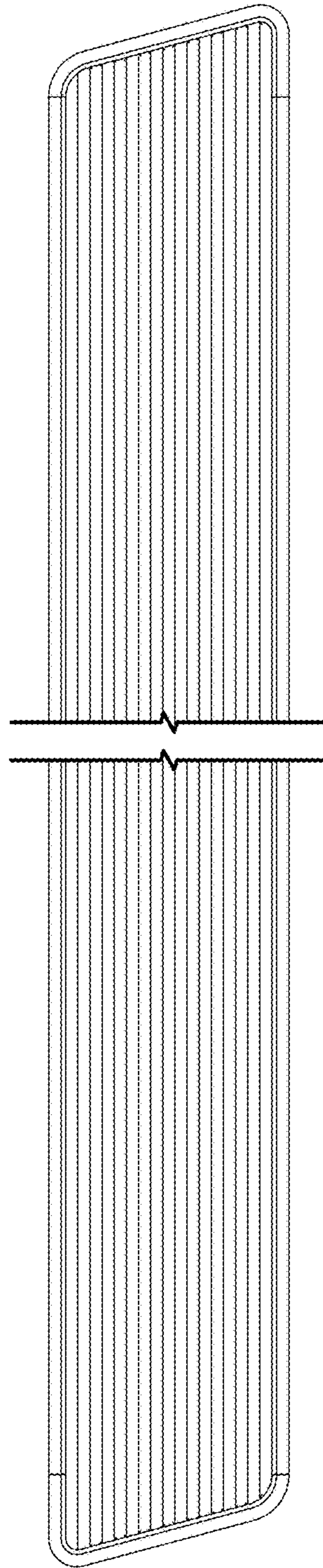

FIG. 18

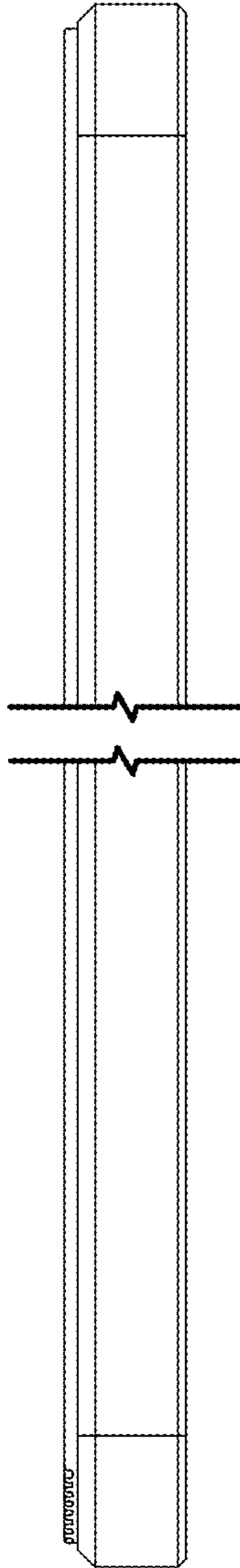

FIG. 19

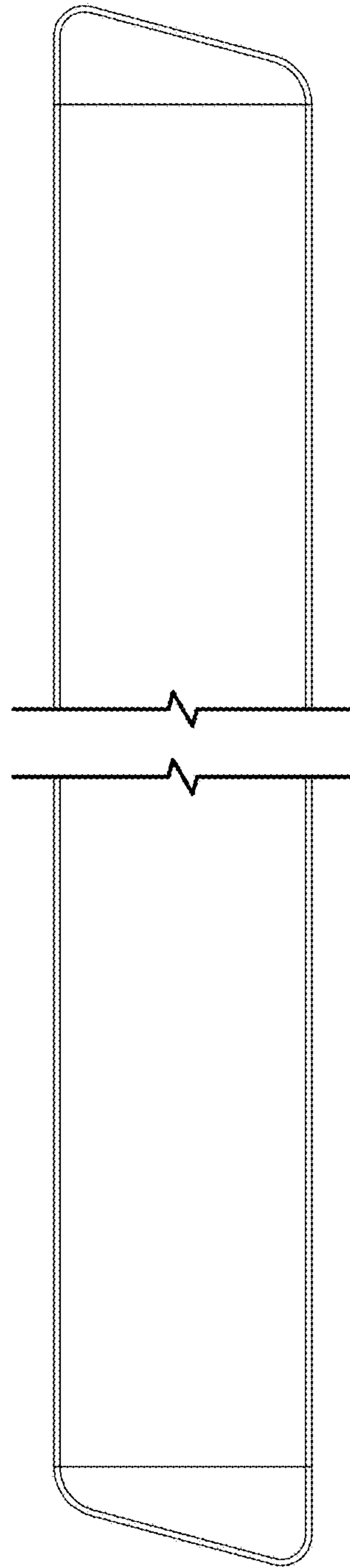

FIG. 20

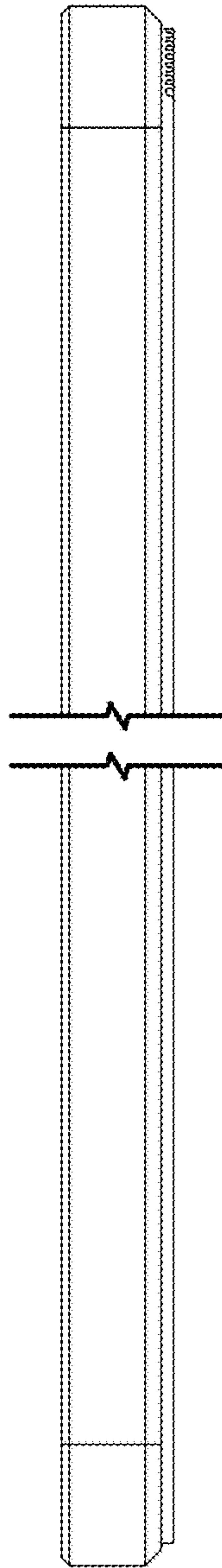

FIG. 21

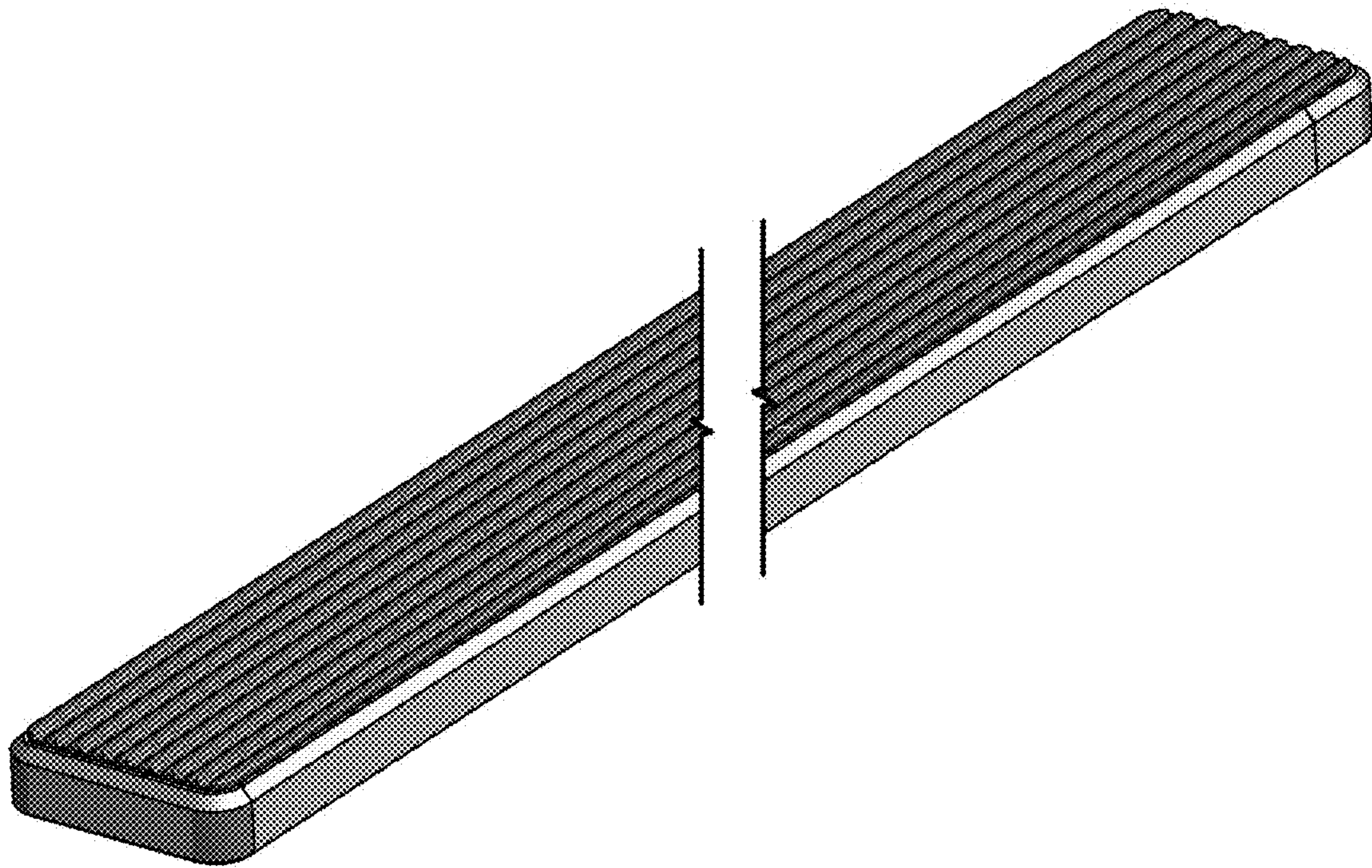

FIG. 22

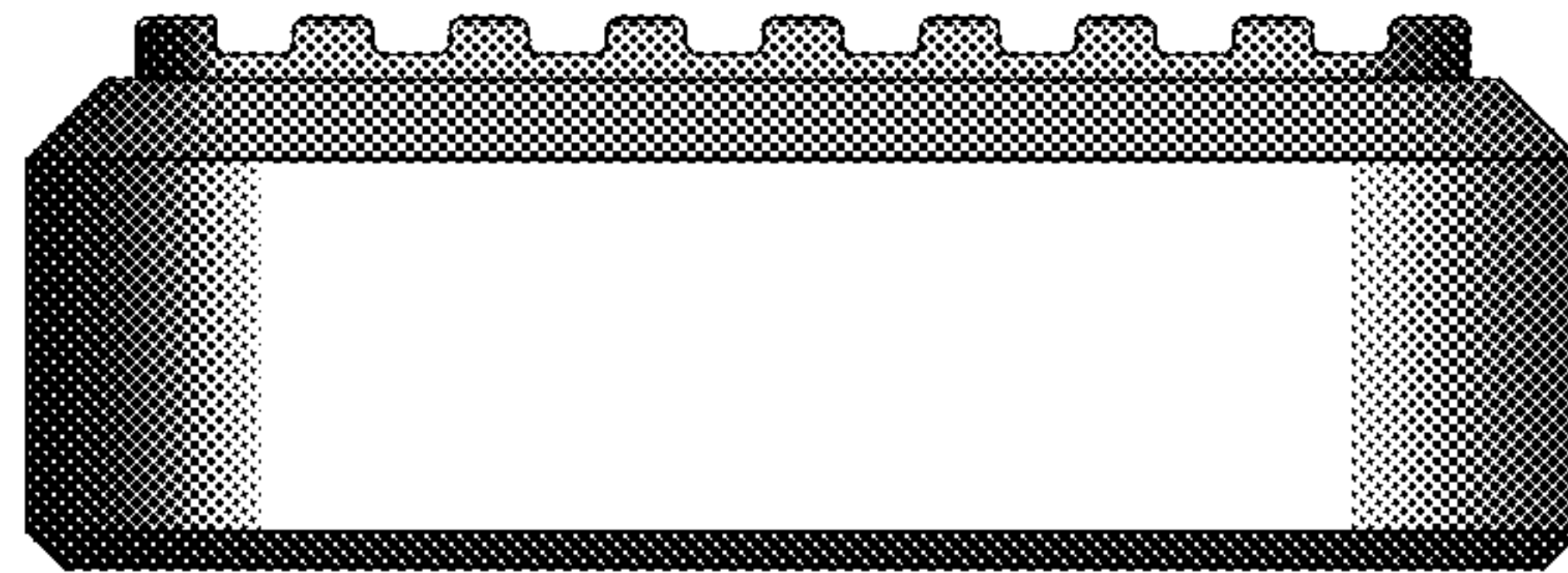

FIG. 23

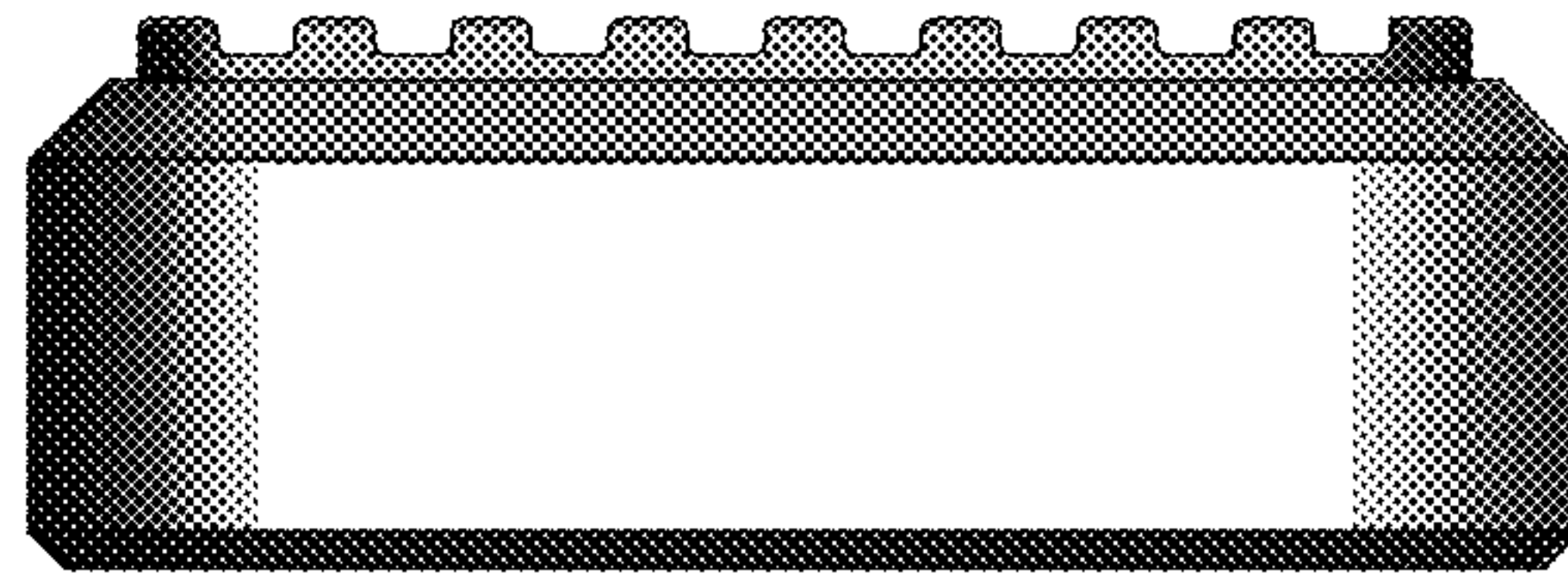

FIG. 24

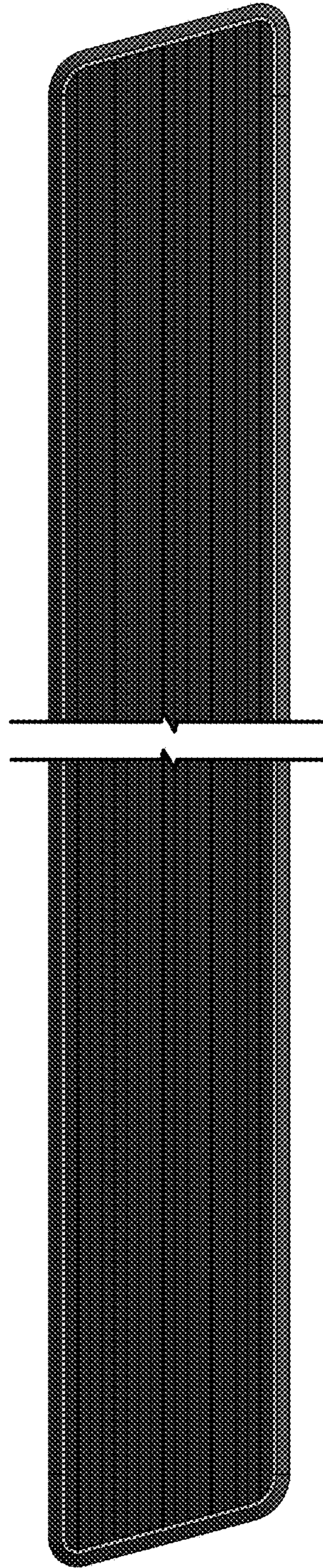

FIG. 25

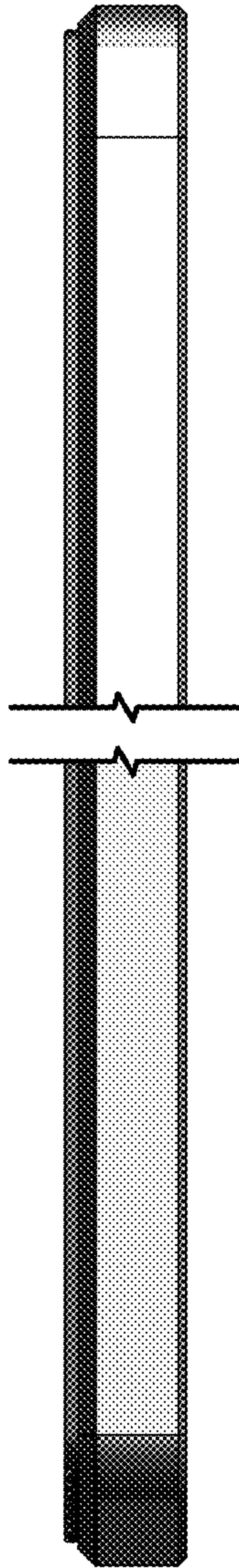

FIG. 26

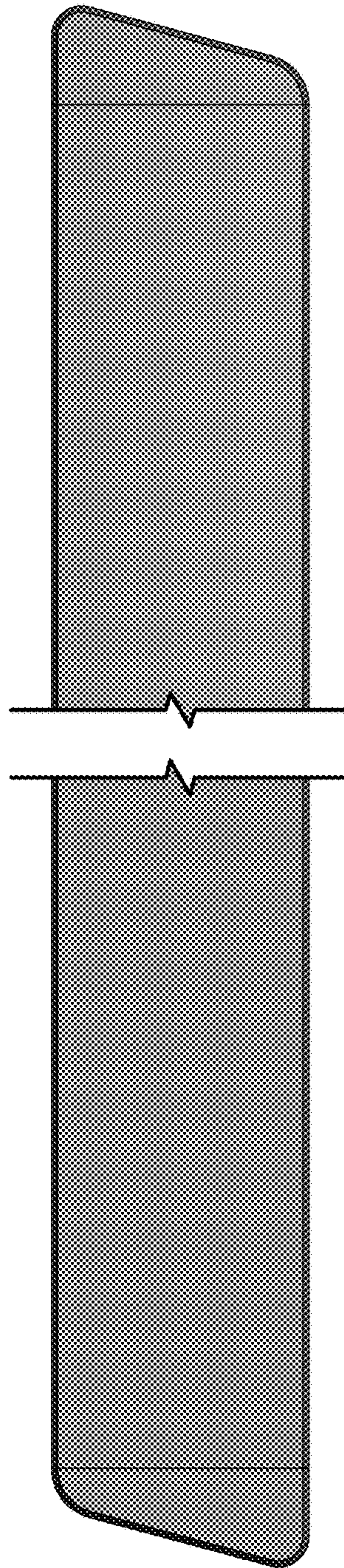

FIG. 27

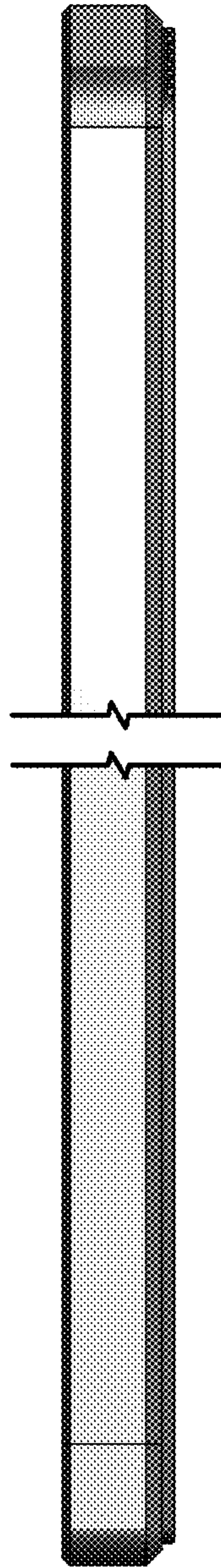

FIG. 28