



US00D843859S

(12) **United States Design Patent**
Thoren et al.

(10) **Patent No.:** **US D843,859 S**
(45) **Date of Patent:** **** Mar. 26, 2019**

(54) **HVAC CONTROL DEVICE**

(71) Applicant: **Daikin Manufacturing Company, L.P.**, Waller, TX (US)

(72) Inventors: **Dennis Thoren**, Lindale, TX (US); **Tao Jia**, Mooresville, NC (US); **Jacky Chen**, Katy, TX (US); **Chris Bellshaw**, Houston, TX (US); **Shawn Beus**, Houston, TX (US); **Kelly Hearnberger**, Katy, TX (US); **Ryohei Hinokuma**, Foster City, CA (US); **Fred Bould**, Menlo Park, CA (US); **Jeremy Wolf**, San Francisco, CA (US); **Byron Lee**, San Mateo, CA (US); **Jamie S. Perin**, San Francisco, CT (US)

(73) Assignee: **DAIKIN MANUFACTURING COMPANY, L.P.**, Houston, TX (US)

(**) Term: **15 Years**

(21) Appl. No.: **29/608,992**

(22) Filed: **Jun. 27, 2017**

(51) **LOC (11) Cl.** **10-04**

(52) **U.S. Cl.**
USPC **D10/50**; D10/60; D13/162.1; D13/177

(58) **Field of Classification Search**
USPC D10/49, 50, 60, 102, 103; D13/162, D13/162.1, 177
CPC H03J 1/0025; H03J 9/00; H03J 9/02; H03J 9/04; H03J 9/06; H01H 2009/187; H01H 9/02; H01H 9/0214; H01H 9/0242; H01H 9/18; H05B 37/02; H05B 37/0272; H05B 39/088; H05B 33/0815; H05B 33/0854; H05B 37/0218; H05B 37/0245; G08C 17/00; G08C 17/02; G08C 19/28; G08C 23/02; G08C 23/04; H04M 1/0262; H04M 1/0266; H04M 2250/12; H04M 2250/22; H05K 5/0017; H05K 5/0243; H05K 5/00; H05K 5/03; G02F 1/1333; G06F 1/1626; G06F 3/0488; G06F 1/1684; G06F 1/30; G06F 3/0362; G06F

3/038; H01M 2/1061; H02J 3/14; H02J 2003/003; Y02B 70/3225; Y10T 307/944; Y10T 307/438; Y04S 10/54; Y04S 20/222; F23N 5/20; F23N 5/203; F23N 5/206; F23N 5/18; F23N 5/184; F23N 5/187; F23N 5/22; F23N 2025/12; F23N 2041/02; F24F 11/00; F24F 11/0012; F24F 11/0009; F24F 11/001; F24F 2011/0057; F24F 2011/0073; F24F 2011/0091; F24F 2011/0094; F24F
(Continued)

(56) **References Cited**

U.S. PATENT DOCUMENTS

D251,482 S * 4/1979 Sugiyama D10/102
D270,815 S * 10/1983 Odom D10/50
(Continued)

Primary Examiner — Antoine Duval Davis

(74) *Attorney, Agent, or Firm* — Manish Vyas

(57) **CLAIM**

The ornamental design for an HVAC control device, as shown and described.

DESCRIPTION

FIG. 1 is a front view of an HVAC control device showing the new design;
FIG. 2 is a right side view thereof;
FIG. 3 is a left side view thereof;
FIG. 4 is a bottom view thereof;
FIG. 5 is a top view thereof;
FIG. 6 is a rear view thereof; and,
FIG. 7 is a front perspective view thereof.
The dashed broken lines represent structures, features or the environment that form no part of the claimed design. And the longer-dash broken lines represent a mounting surface that is environmental and forms no part of the claimed design.

1 Claim, 5 Drawing Sheets

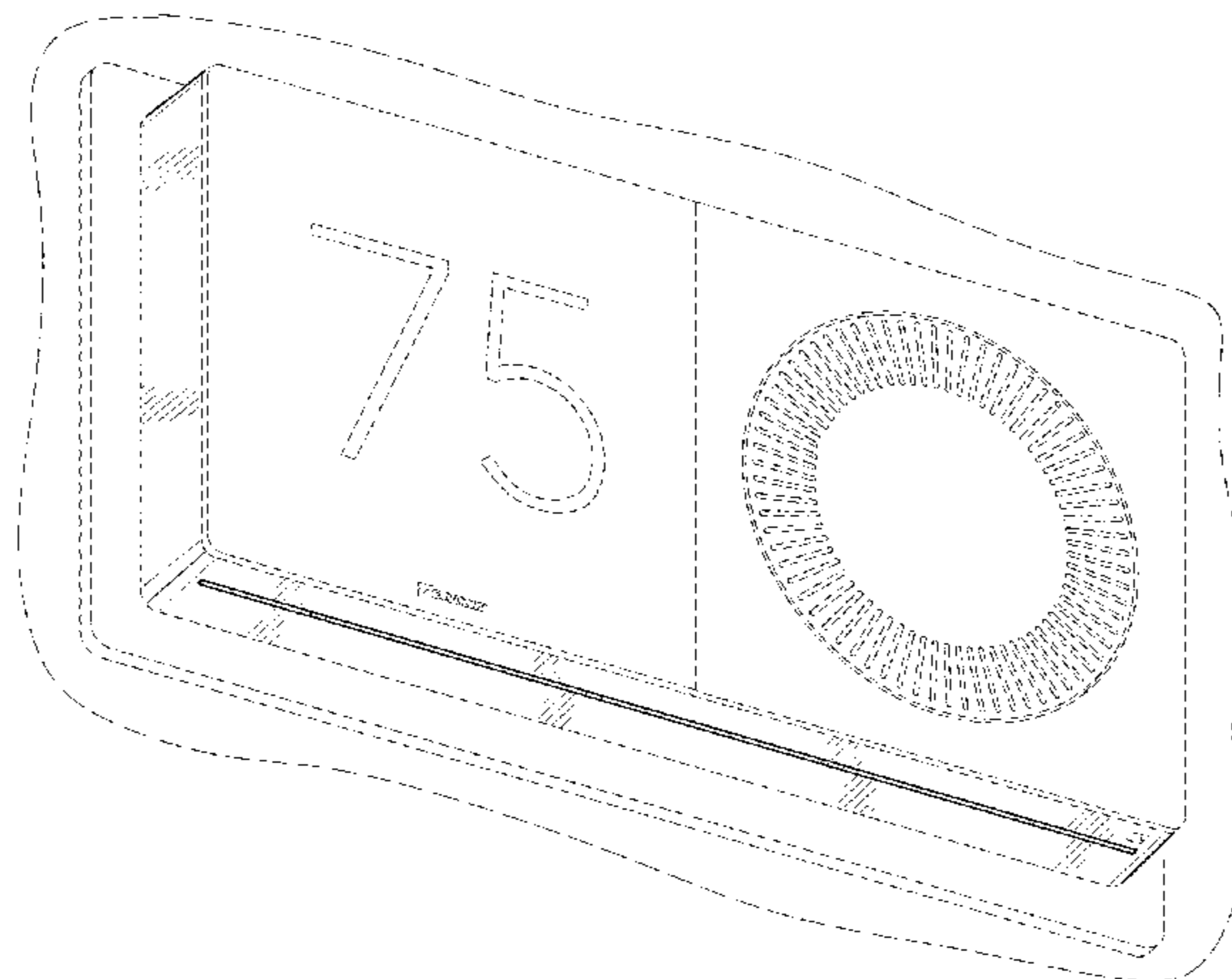

(58) **Field of Classification Search**

CPC 2011/0068; F24F 2011/0012; F24F
2011/0015; F24F 2011/0017; F21V 11/16;
F21V 33/10; G05B 19/042; G05D 23/01;
G05D 23/12; G05D 23/275; G05D
23/1902; G05D 23/1904; G05D
23/27502; G05D 23/27503; G05D
23/1919; G05D 23/19; G05D 23/2723;
G05D 23/00; G09F 13/22; G09F 9/53

See application file for complete search history.

(56) **References Cited**

U.S. PATENT DOCUMENTS

D614,976 S * 5/2010 Skafdrup D10/50
D723,948 S * 3/2015 Baumgartner D10/50
D772,735 S * 11/2016 Mansueto D10/50
2017/0082313 A1 * 3/2017 Benichou F24F 11/0086

* cited by examiner

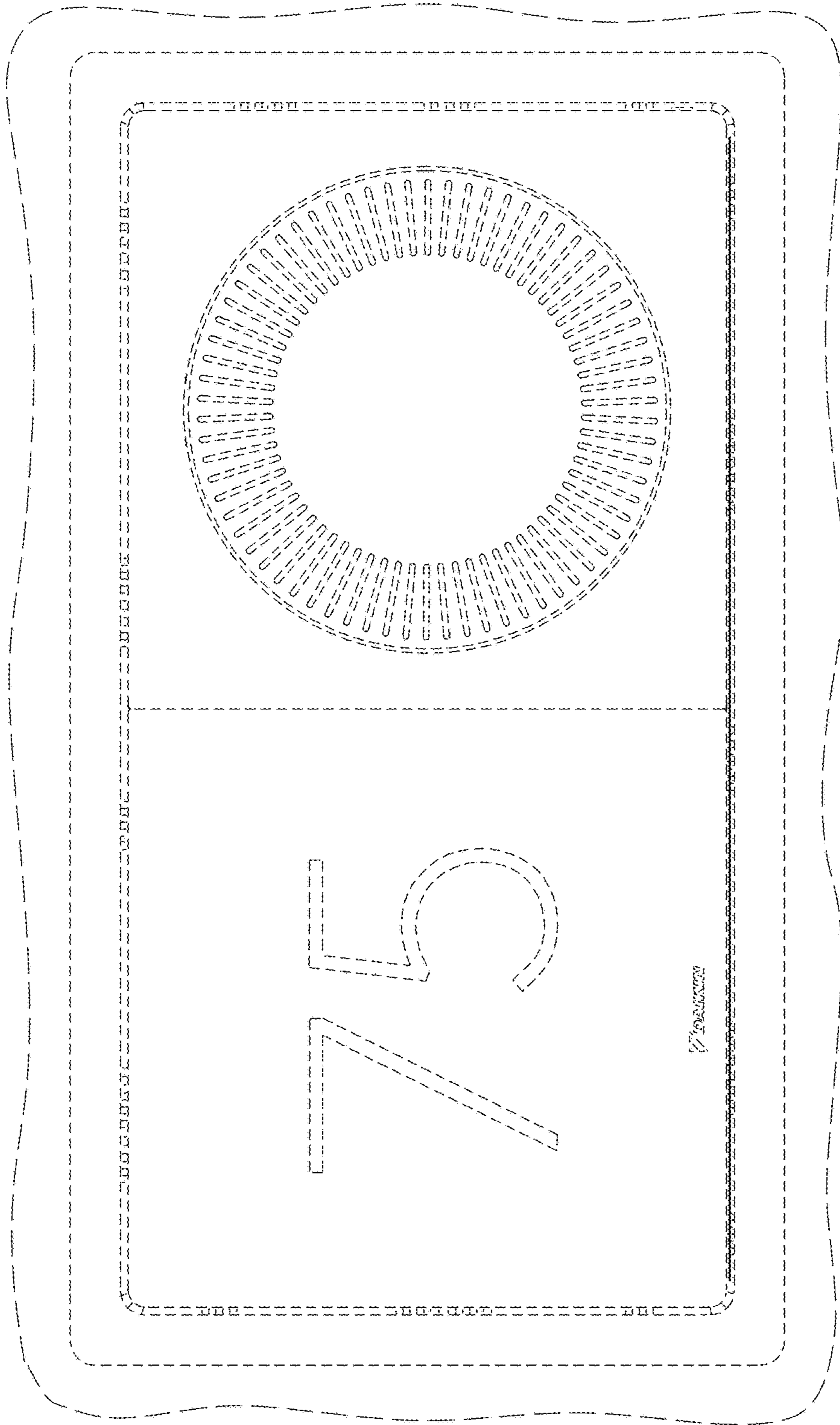

FIG. 1

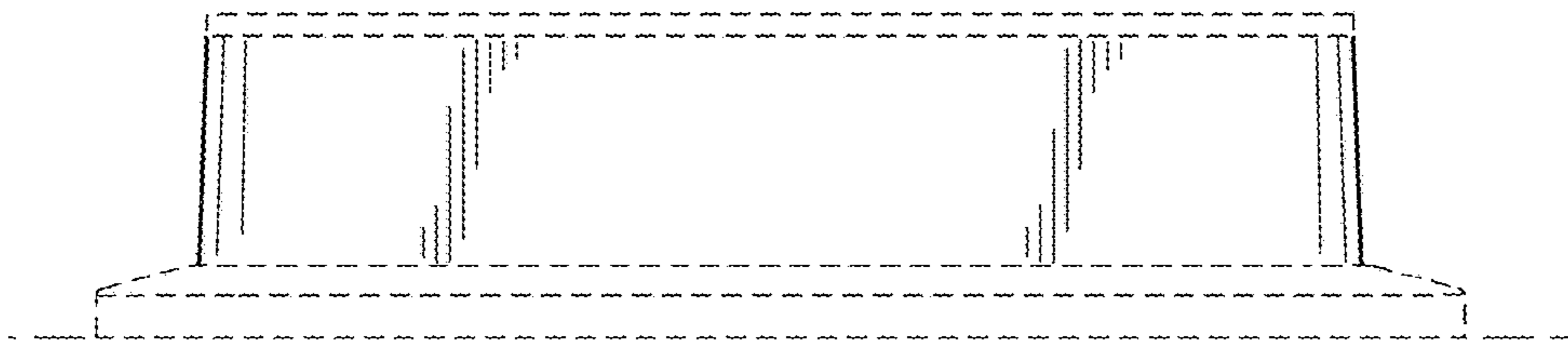

FIG. 3

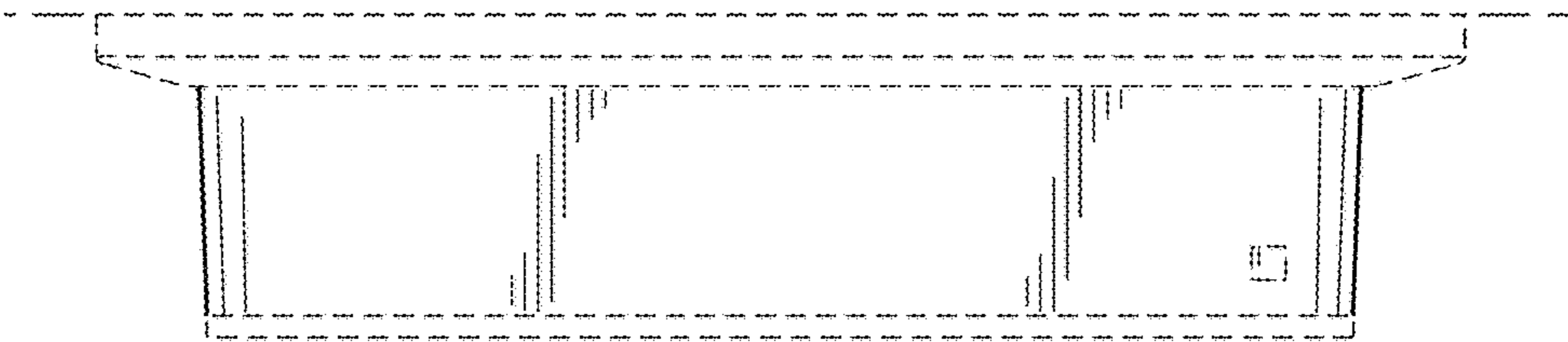

FIG. 2

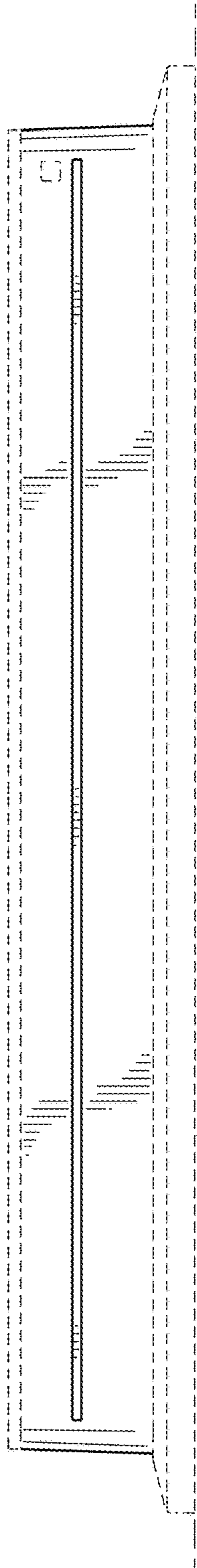

FIG. 4

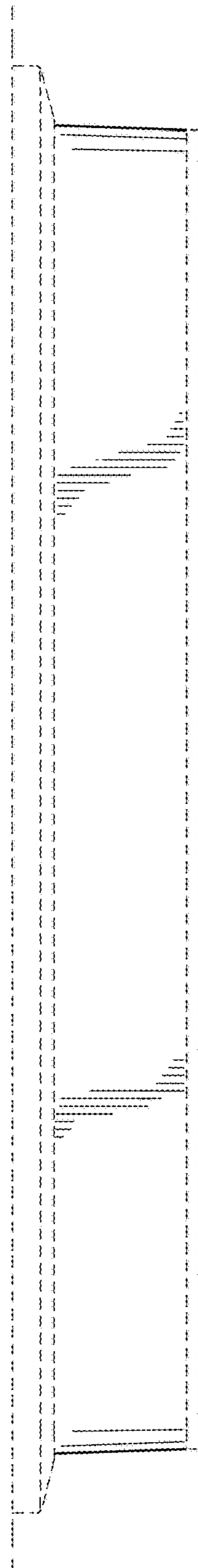

FIG. 5

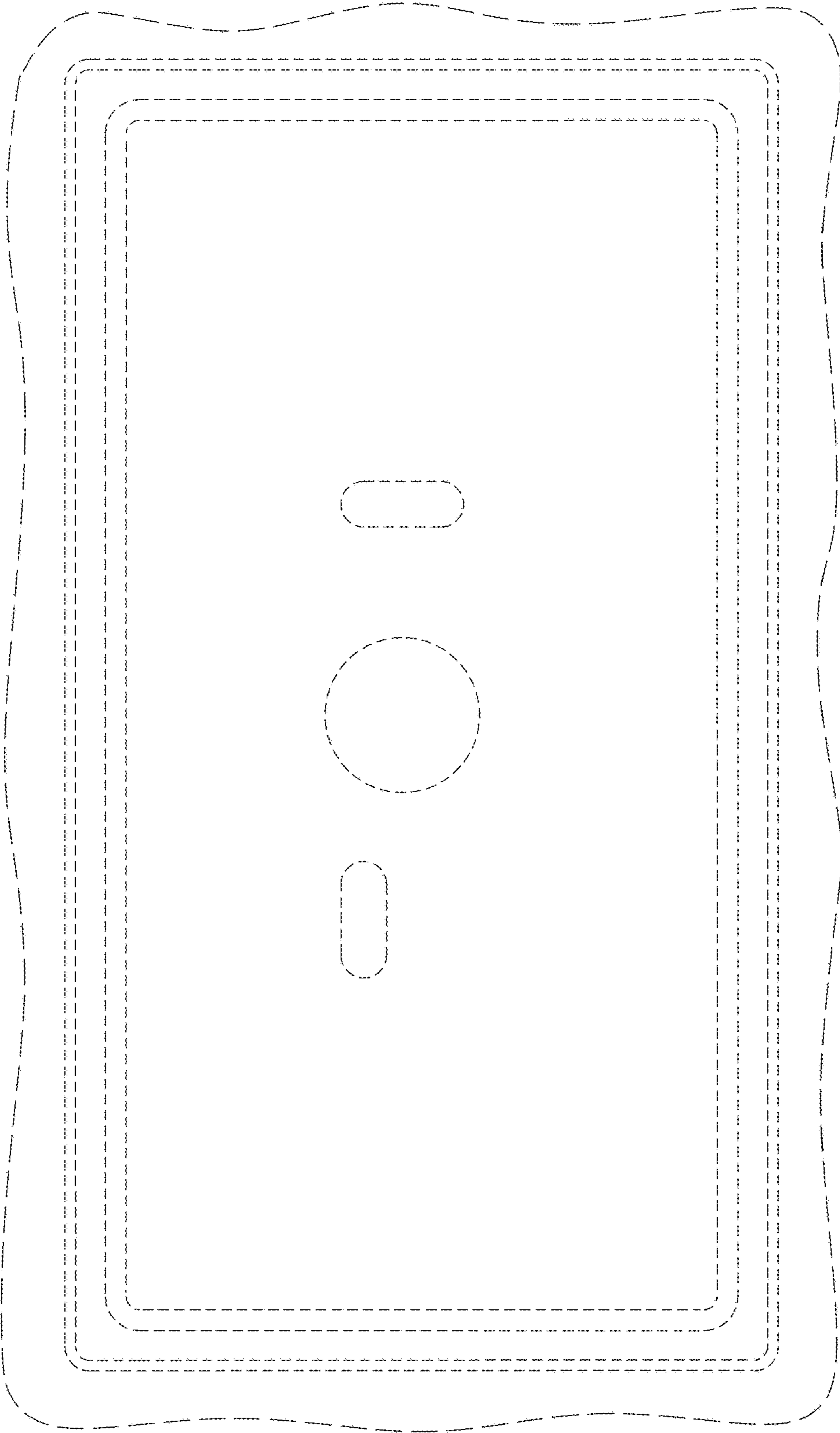

FIG. 6

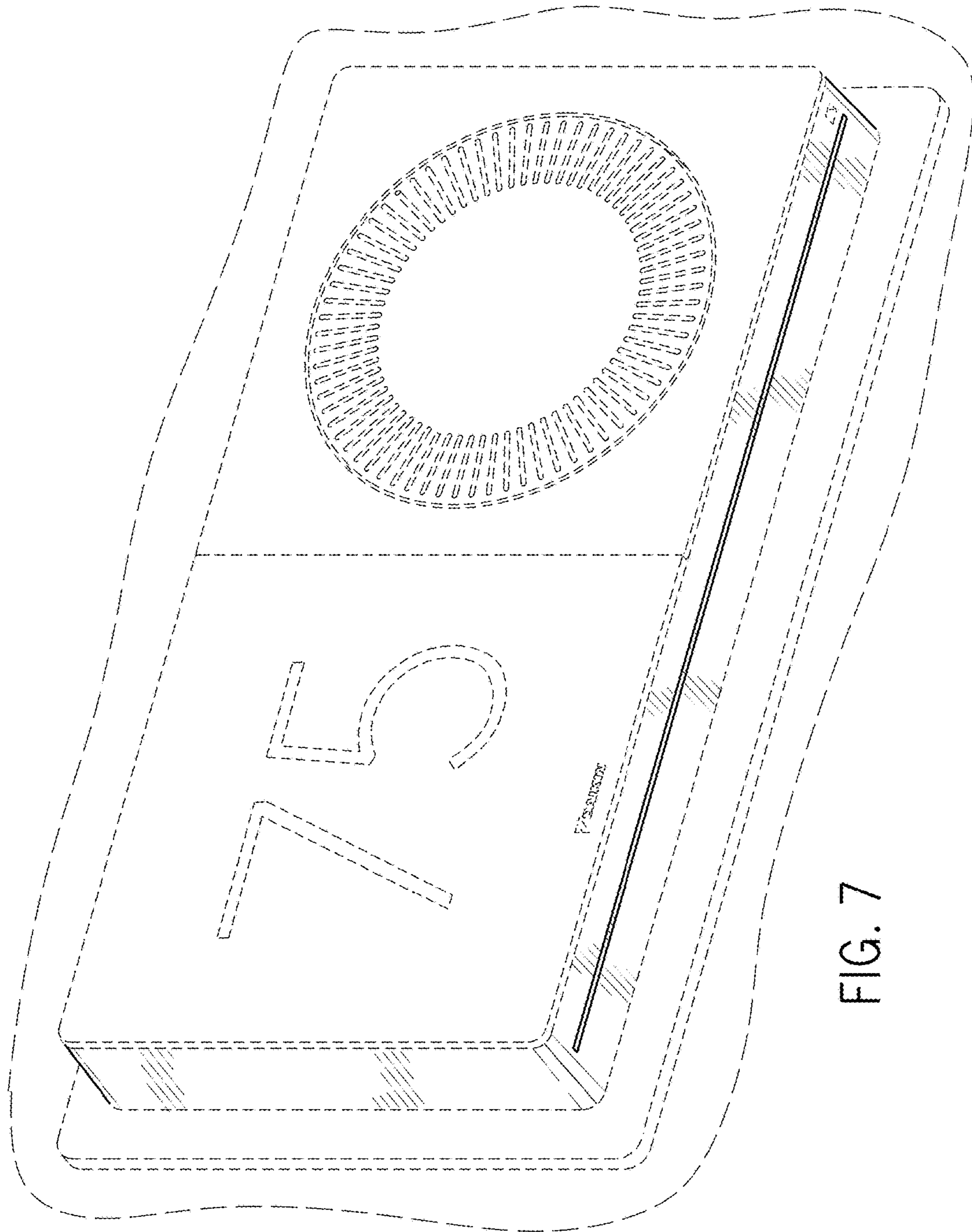

FIG. 7