



US00D843853S

(12) **United States Design Patent**
Wu

(10) **Patent No.:** **US D843,853 S**

(45) **Date of Patent:** **** Mar. 26, 2019**

(54) **WATCH**

(71) Applicant: **Yanxiong Wu**, Guangdong (CN)

(72) Inventor: **Yanxiong Wu**, Guangdong (CN)

(**) Term: **15 Years**

(21) Appl. No.: **29/601,742**

(22) Filed: **Apr. 26, 2017**

(51) **LOC (11) Cl.** **10-02**

(52) **U.S. Cl.**
USPC **D10/39**

(58) **Field of Classification Search**
USPC D10/30, 31, 32, 33, 34, 35, 36, 37, 38,
D10/39, 122, 123, 124, 128, 102; D11/1,
D11/2, 3, 4; D14/300, 341, 344, 137,
D14/138 R, 138 G
CPC G04B 17/00; G04B 17/02; G04B 17/005;
G04B 17/285; G04B 37/00; G04B
37/0058; G04B 45/00; G04B 45/02;
G04B 45/0038; G04B 45/0069; G04B
45/0076; G04B 29/00; G04B 19/268
See application file for complete search history.

(56) **References Cited**

U.S. PATENT DOCUMENTS

D32,683 S	*	5/1900	Baldwin	D10/1
D93,814 S	*	11/1934	Brown	D10/102
D203,760 S	*	2/1966	Morris	D10/1
D278,688 S	*	5/1985	Giugiaro	D10/30
D286,755 S	*	11/1986	Manfredi	D10/39
D301,693 S	*	6/1989	Canta	D10/126
D319,028 S	*	8/1991	Bourquin	D10/39
D368,664 S	*	4/1996	Schick	D10/30
D549,113 S	*	8/2007	Duong	D10/32
D553,019 S	*	10/2007	Senggen	D10/32

D615,883 S	*	5/2010	Laucella	D10/39
D622,164 S	*	8/2010	Mikkelsen	D10/32
D726,557 S	*	4/2015	Lasserre	D10/39
D728,386 S	*	5/2015	Galli	D10/39
D779,342 S	*	2/2017	Lintz	D10/30
D782,339 S	*	3/2017	White	D10/39

OTHER PUBLICATIONS

Amazon, Style Feathers Paidu Analog Watch, posted Sep. 13, 2016, [online], [site visited Sep. 8, 2018]. Available from Internet, <URL: <https://www.amazon.in/Style-Feathers-Paidu-Analog-Men-58791/dp/B01M0QXZ1M>> (Year: 2016).*

Flickr, Moonphase watches, Half-dial watches, posted Jun. 2, 2010, [online], [site visited Sep. 8, 2018]. Available from Internet, <URL: <https://www.flickr.com/photos/27862259@N02/5781904224>> (Year: 2010).*

Youtube, Mr. Jones Watches—Sun and Moon, posted Jan. 25, 2013, [online], [site visited Sep. 10, 2018]. Available from Internet, <URL: <https://www.youtube.com/watch?v=GXkuOFMZ6e8>> (Year: 2013).*

* cited by examiner

Primary Examiner — Sheryl Lane
Assistant Examiner — Samantha N Wood

(57) **CLAIM**

The ornamental design for a watch, as shown.

DESCRIPTION

FIG. 1 is a front elevational view of a watch showing my new design;
FIG. 2 is a rear elevational view thereof;
FIG. 3 is a left side view thereof;
FIG. 4 is a right side view thereof;
FIG. 5 is a top plan view thereof; and,
FIG. 6 is a bottom plan view thereof.

1 Claim, 6 Drawing Sheets

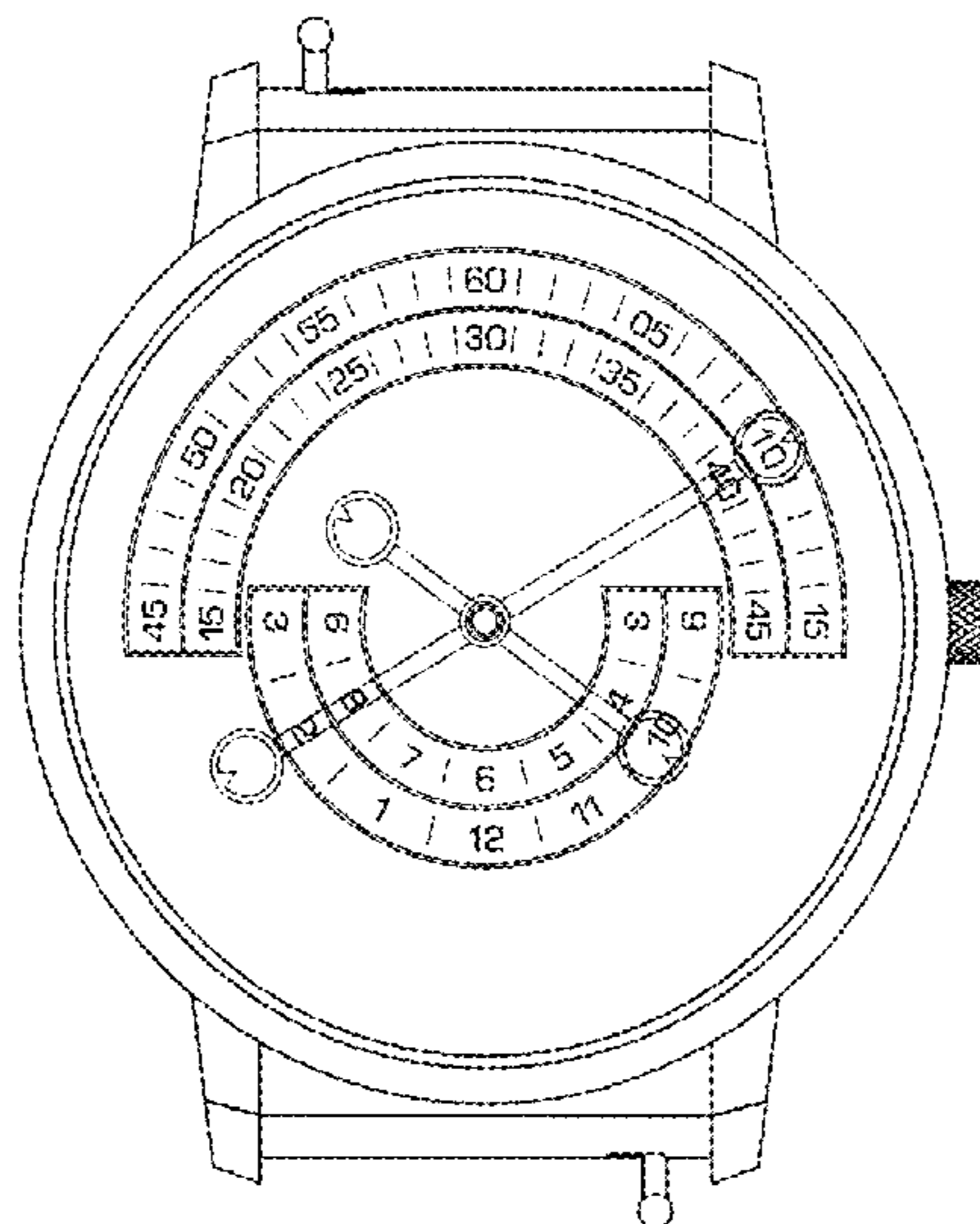

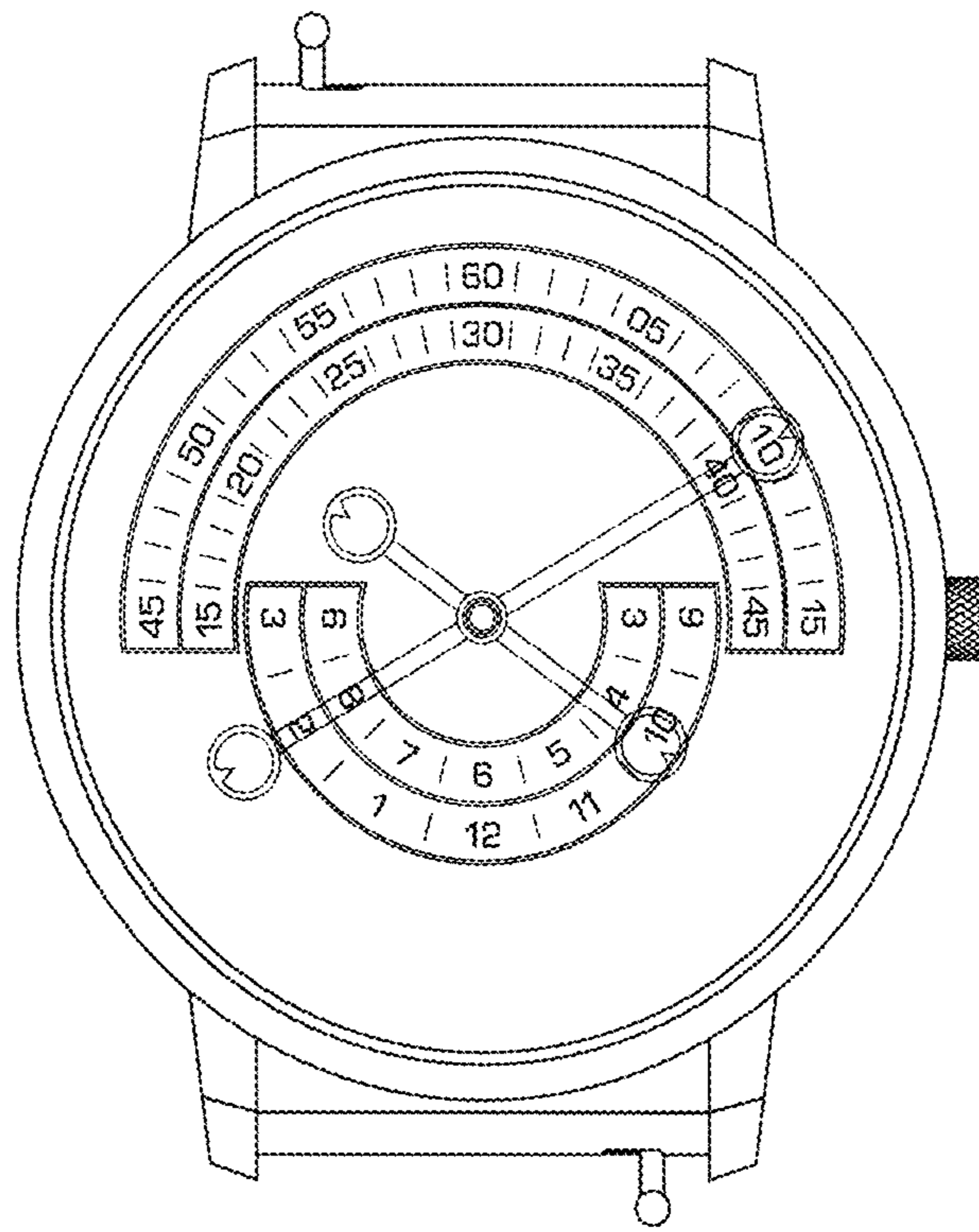

FIG. 1

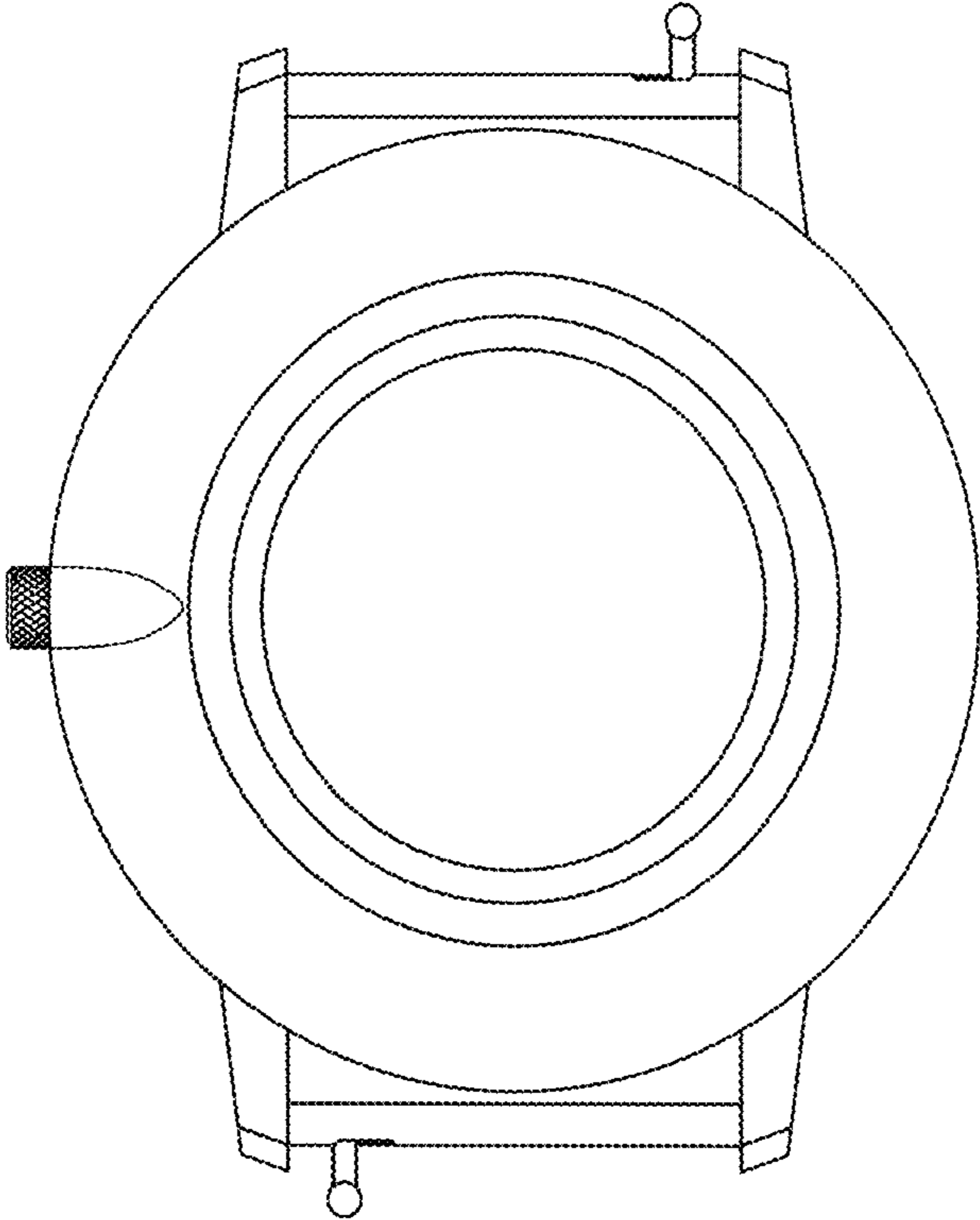

FIG.2

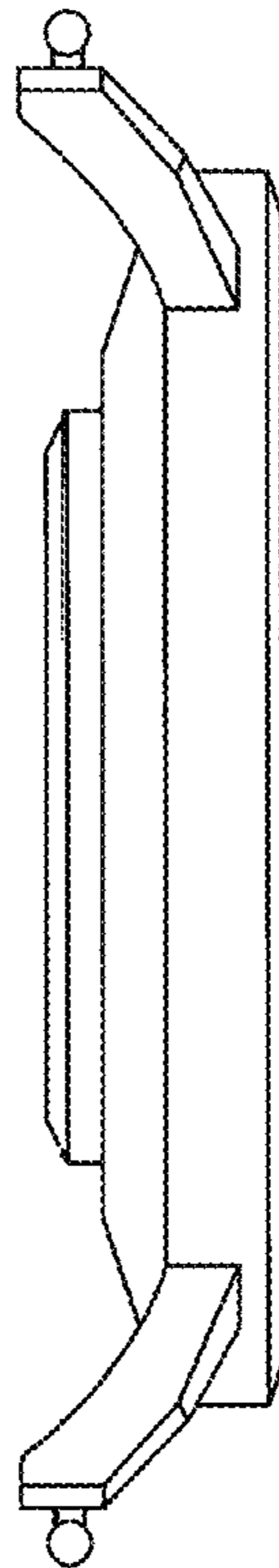

FIG.3

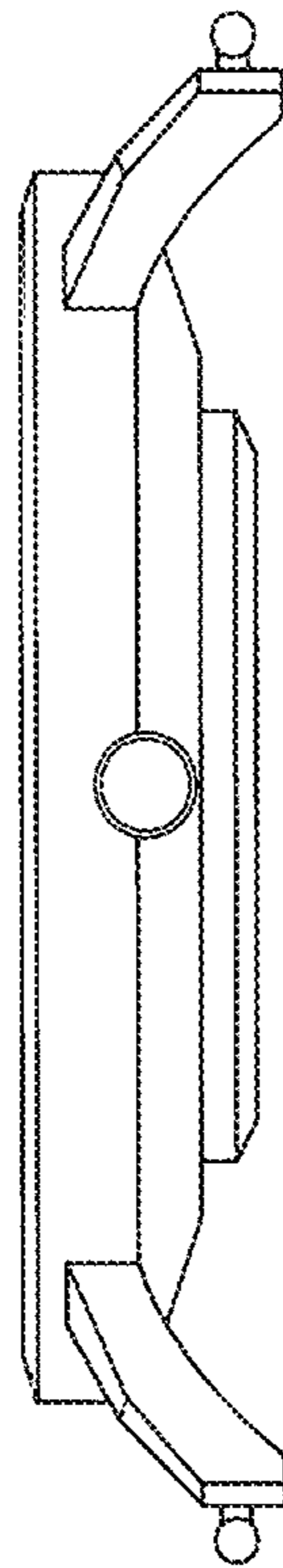

FIG. 4

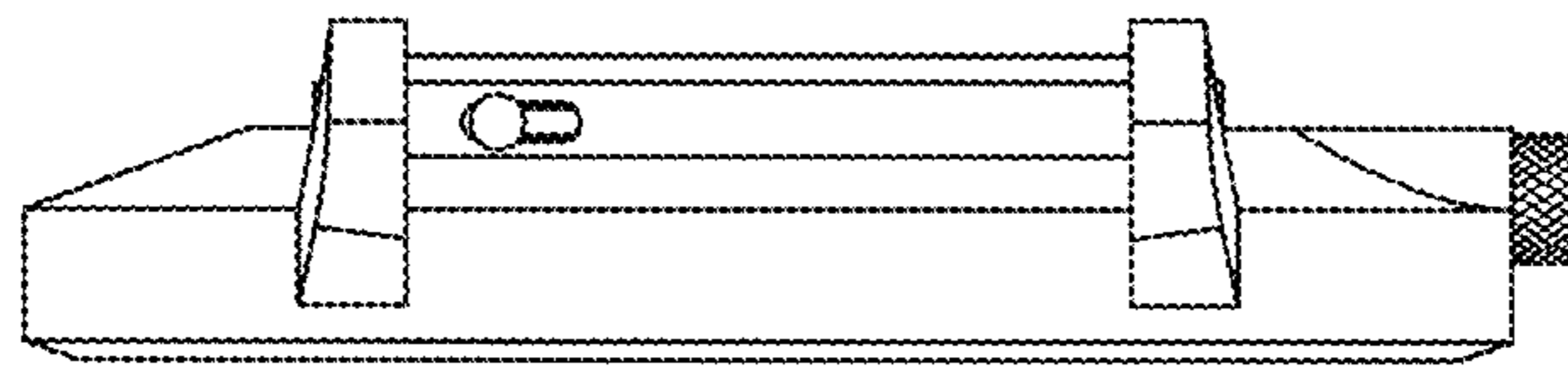

FIG. 5

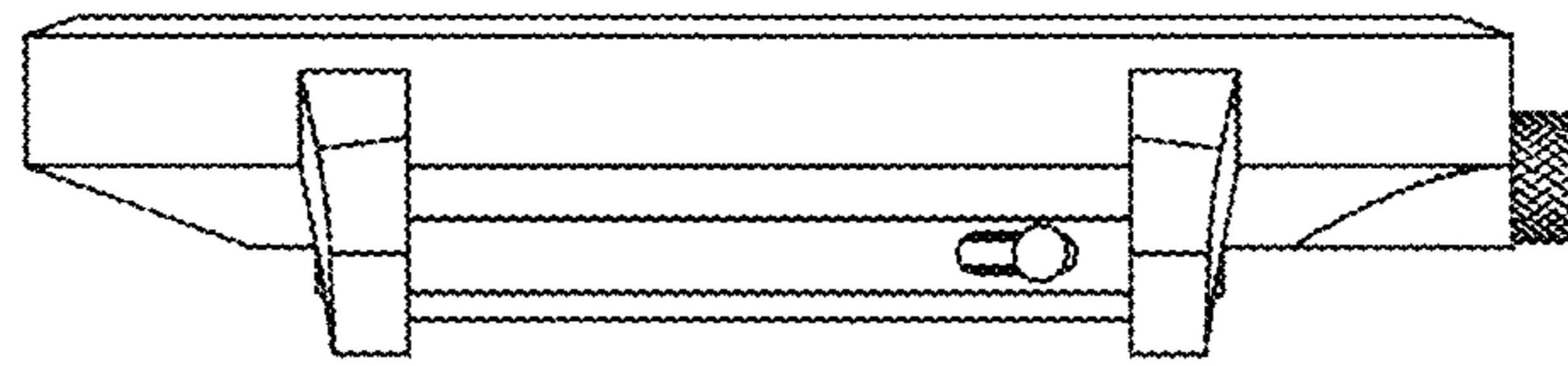

FIG.6