



US00D843797S

(12) **United States Design Patent**
Joseph

(10) **Patent No.:** **US D843,797 S**
(45) **Date of Patent:** **** Mar. 26, 2019**

(54) **FOLDING CHOPPING BOARD**

(71) Applicant: **Joseph Joseph Ltd.**, London (GB)

(72) Inventor: **Antony Joseph**, London (GB)

(73) Assignee: **Joseph Joseph Ltd.**, London (GB)

(**) Term: **15 Years**

(21) Appl. No.: **29/633,810**

(22) Filed: **Jan. 16, 2018**

(30) **Foreign Application Priority Data**

Jul. 17, 2017 (EM) 004107217-0004

(51) **LOC (11) Cl.** **07-04**

(52) **U.S. Cl.**
USPC **D7/698**

(58) **Field of Classification Search**
USPC D6/703.1; D7/393, 396.1, 543, 549,
D7/550.1, 586, 698-699; D32/55-57
CPC A47J 47/00; A47J 47/005; A47J 47/20;
B26D 7/0006; B26D 7/018; B26D 7/20;
B23D 21/00; B23K 37/04; B23K 37/053;
B23Q 16/001
See application file for complete search history.

(56) **References Cited**

U.S. PATENT DOCUMENTS

D283,390 S * 4/1986 McGinnis D7/698
D363,195 S * 10/1995 Bransby D7/698

D382,735 S * 8/1997 Zapf D6/703.1
D492,166 S * 6/2004 Kaposi D7/698
D673,007 S * 12/2012 Zox D7/393
D700,025 S * 2/2014 Murison D7/698
D720,179 S * 12/2014 Zox D7/396.1
D752,383 S * 3/2016 Zox D7/396.1
D804,259 S * 12/2017 Donald D7/698

* cited by examiner

Primary Examiner — Ricky Pham

(74) *Attorney, Agent, or Firm* — Millen, White, Zelano & Branigan, PC

(57) **CLAIM**

The ornamental design for a folding chopping board, as shown and described.

DESCRIPTION

FIG. 1 is a top view of the folding chopping board showing my new design.
FIG. 2 is a bottom view thereof.
FIG. 3 is another top view thereof.
FIG. 4 is another top view thereof.
FIG. 5 is another bottom view thereof.
FIG. 6 is a side view thereof.
FIG. 7 is another side view thereof.
FIG. 8 is another side view thereof; and,
FIG. 9 is another side view thereof.
The broken lines in the drawings illustrate portions of the folding chopping board which form no part of the claimed design.

1 Claim, 9 Drawing Sheets

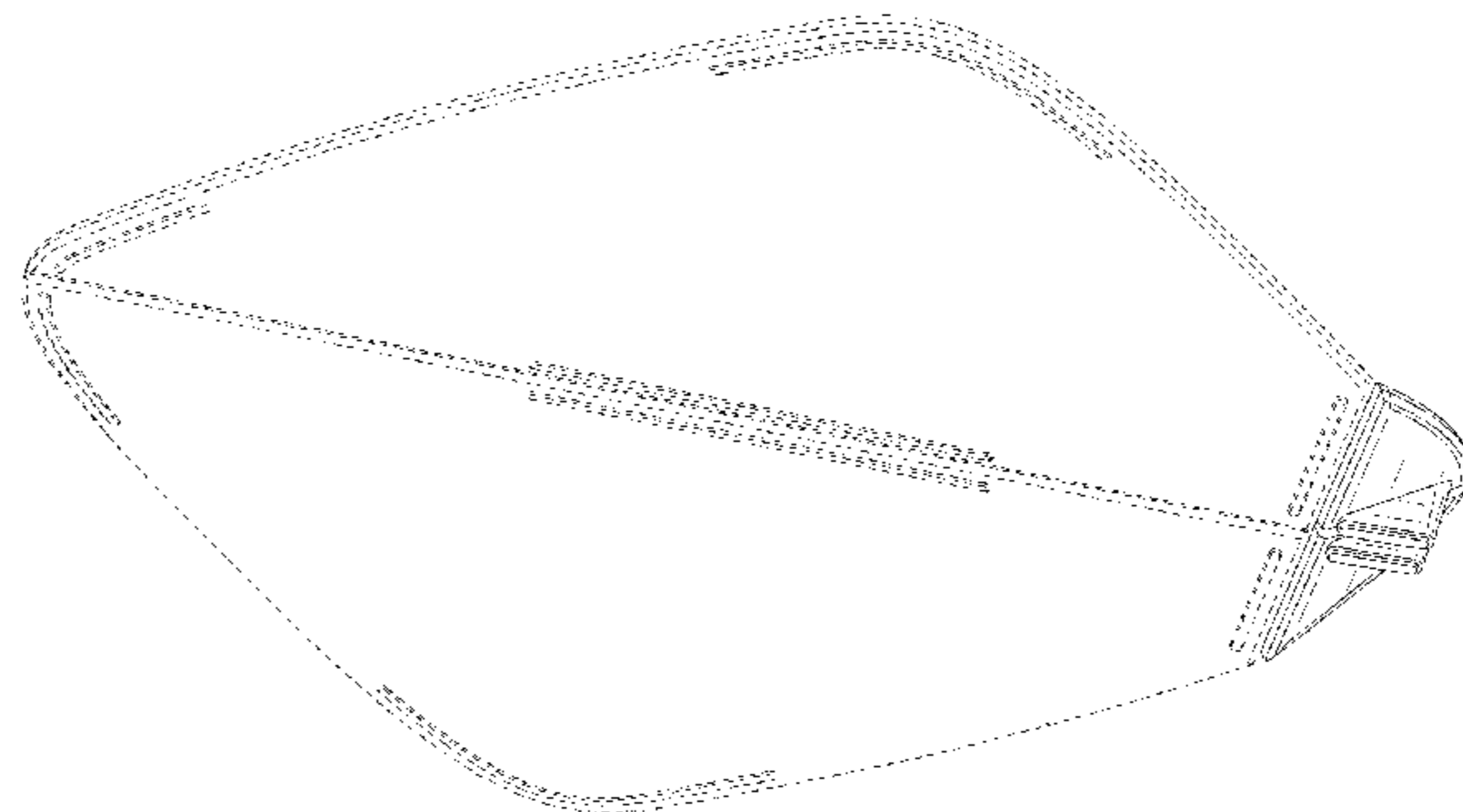
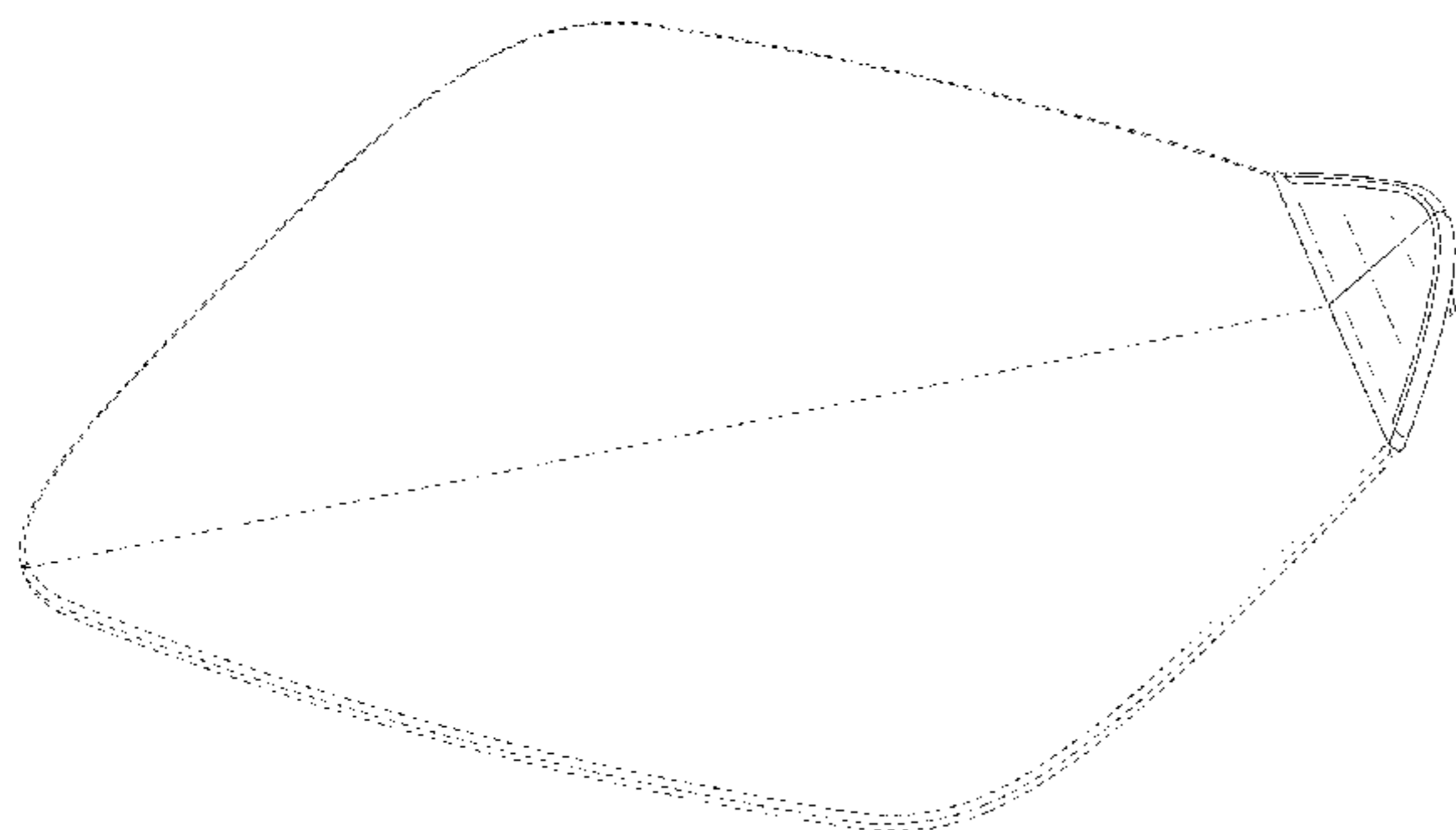

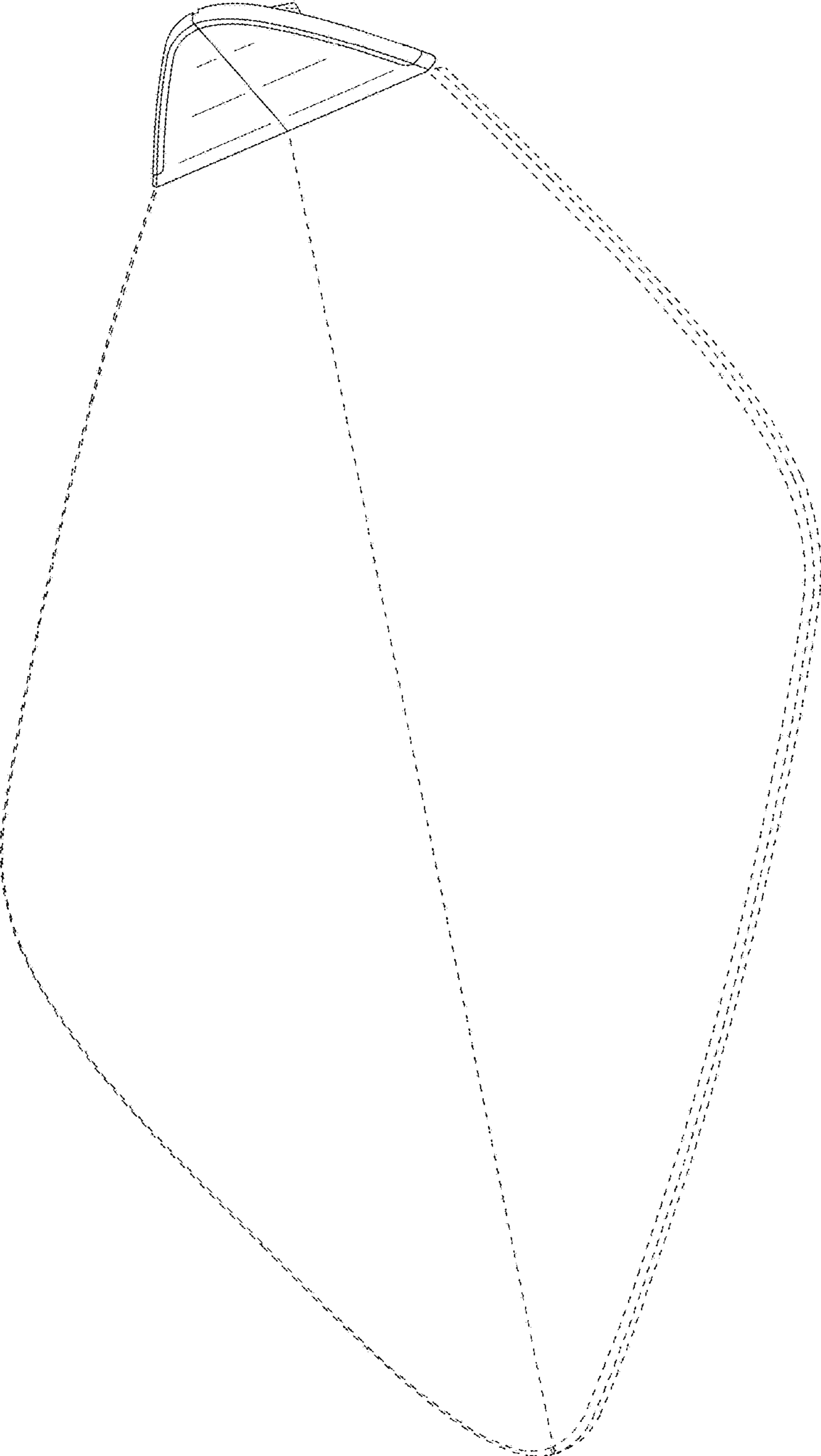

FIG. 1

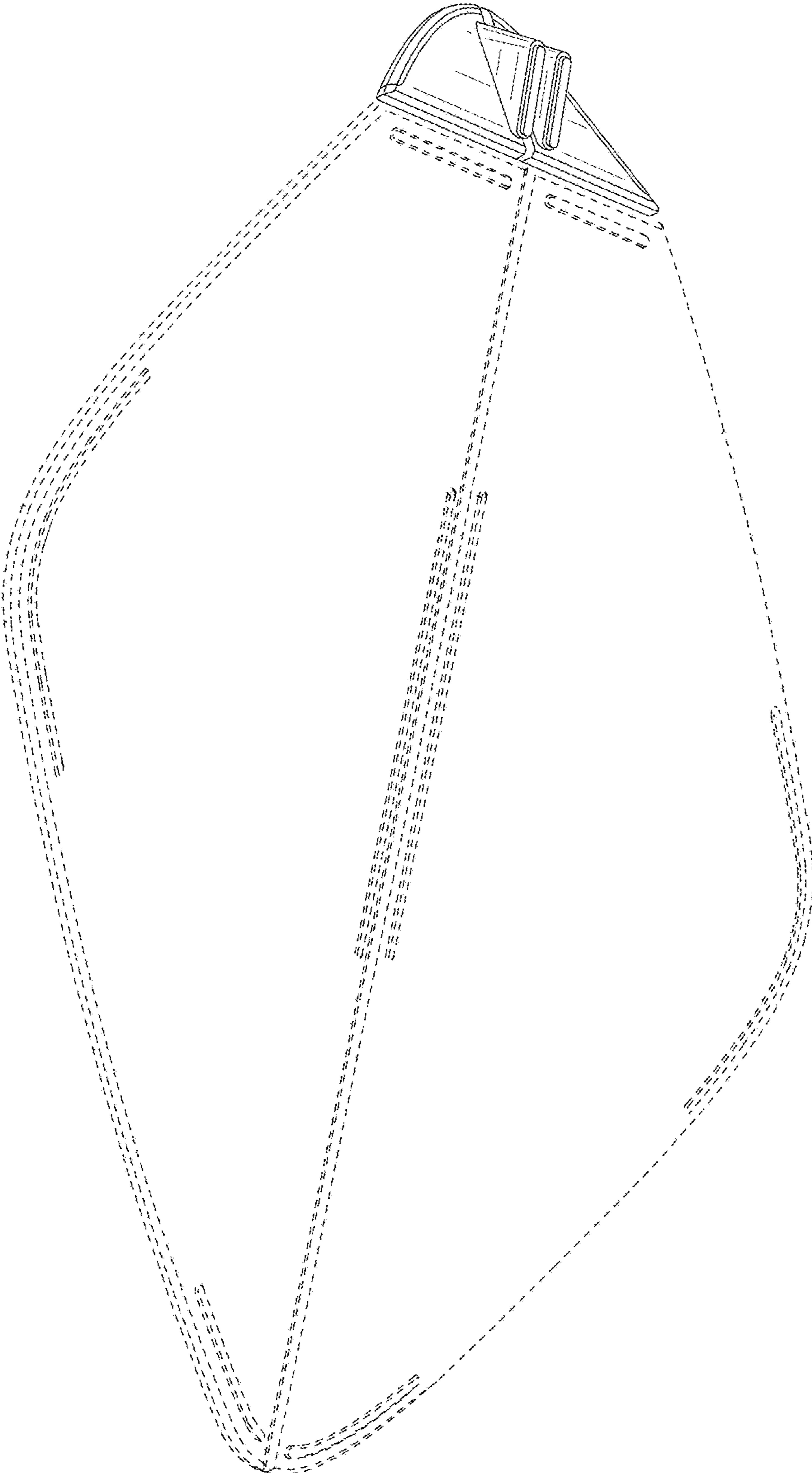

FIG. 2

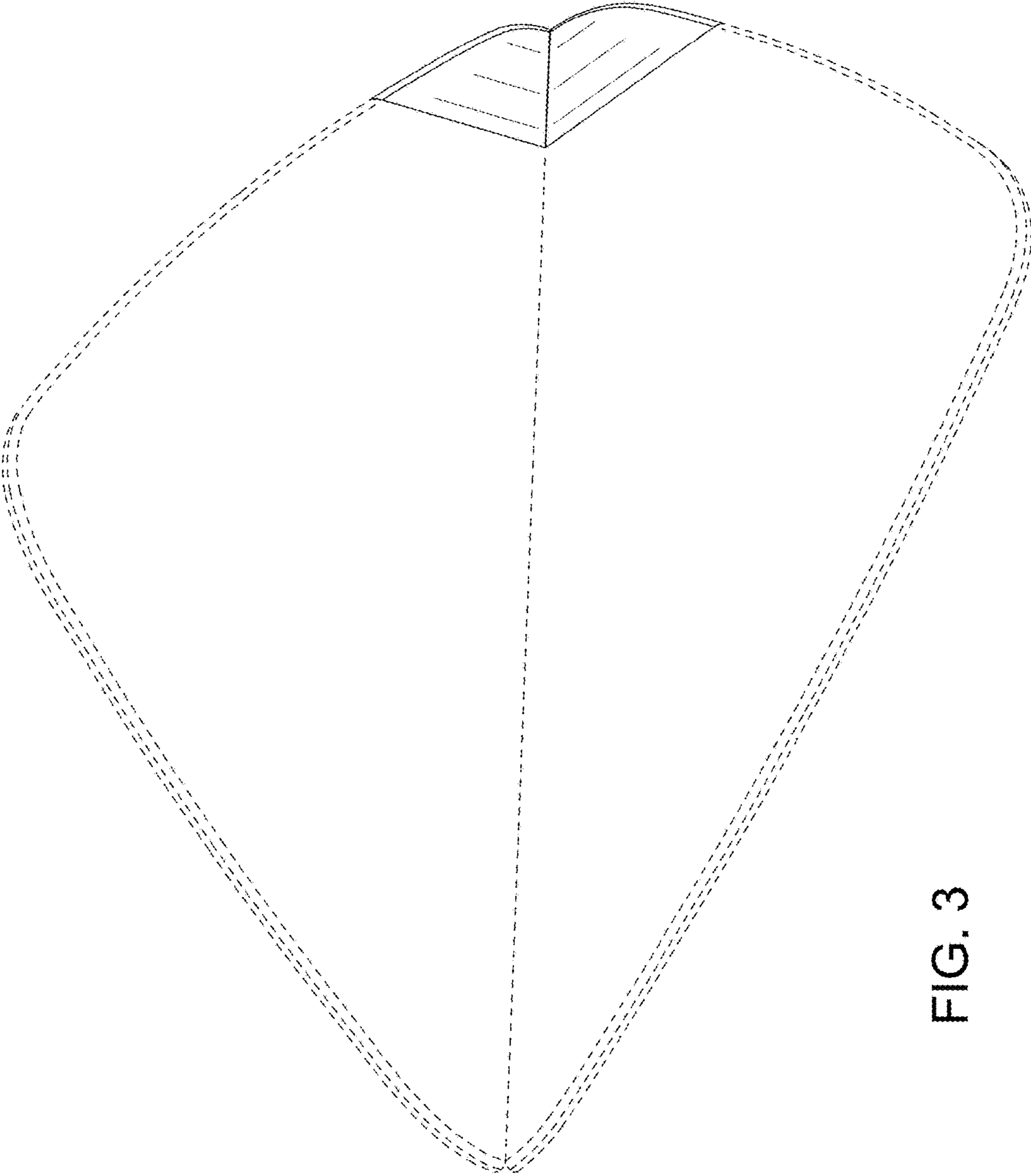

FIG. 3

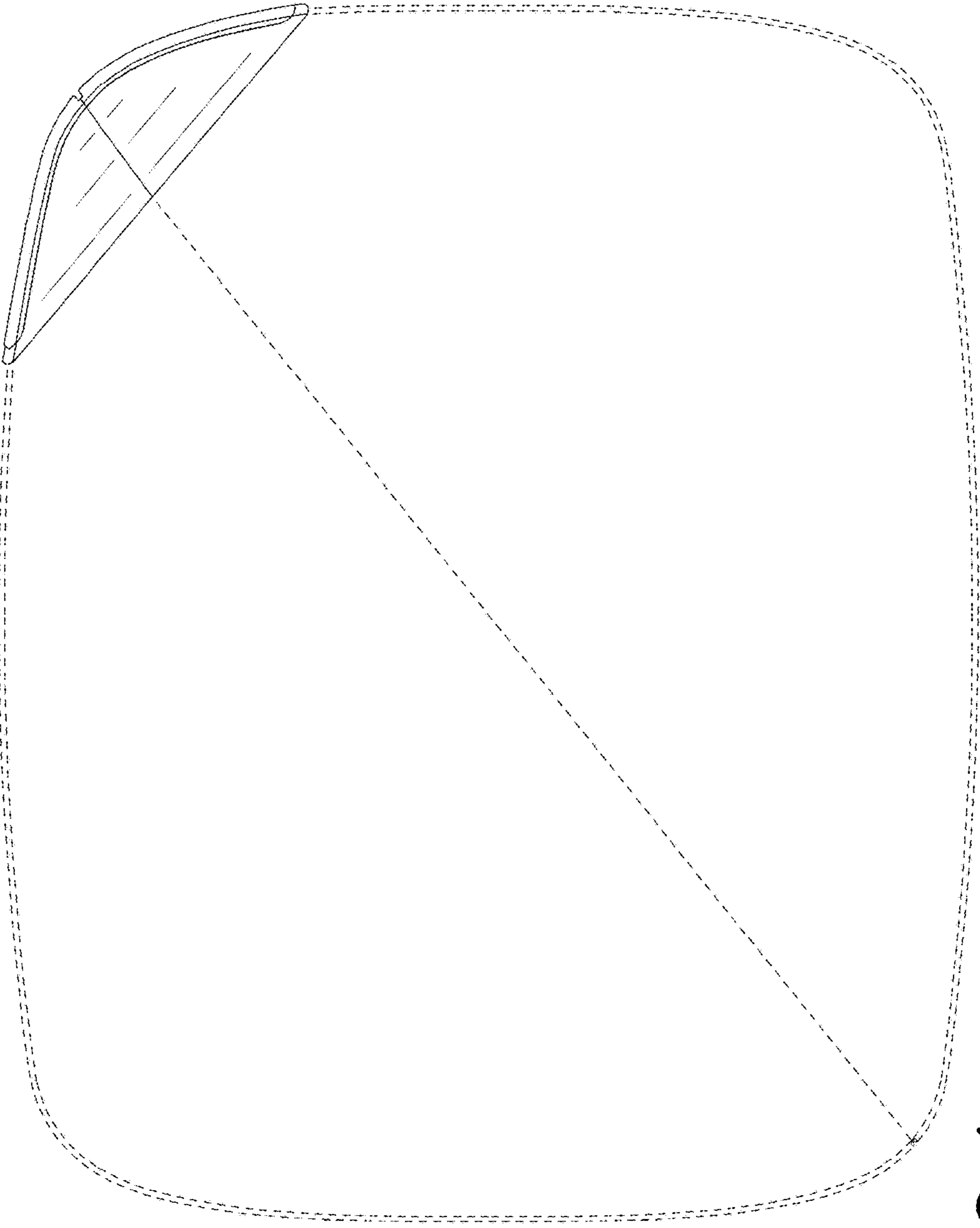

FIG. 4

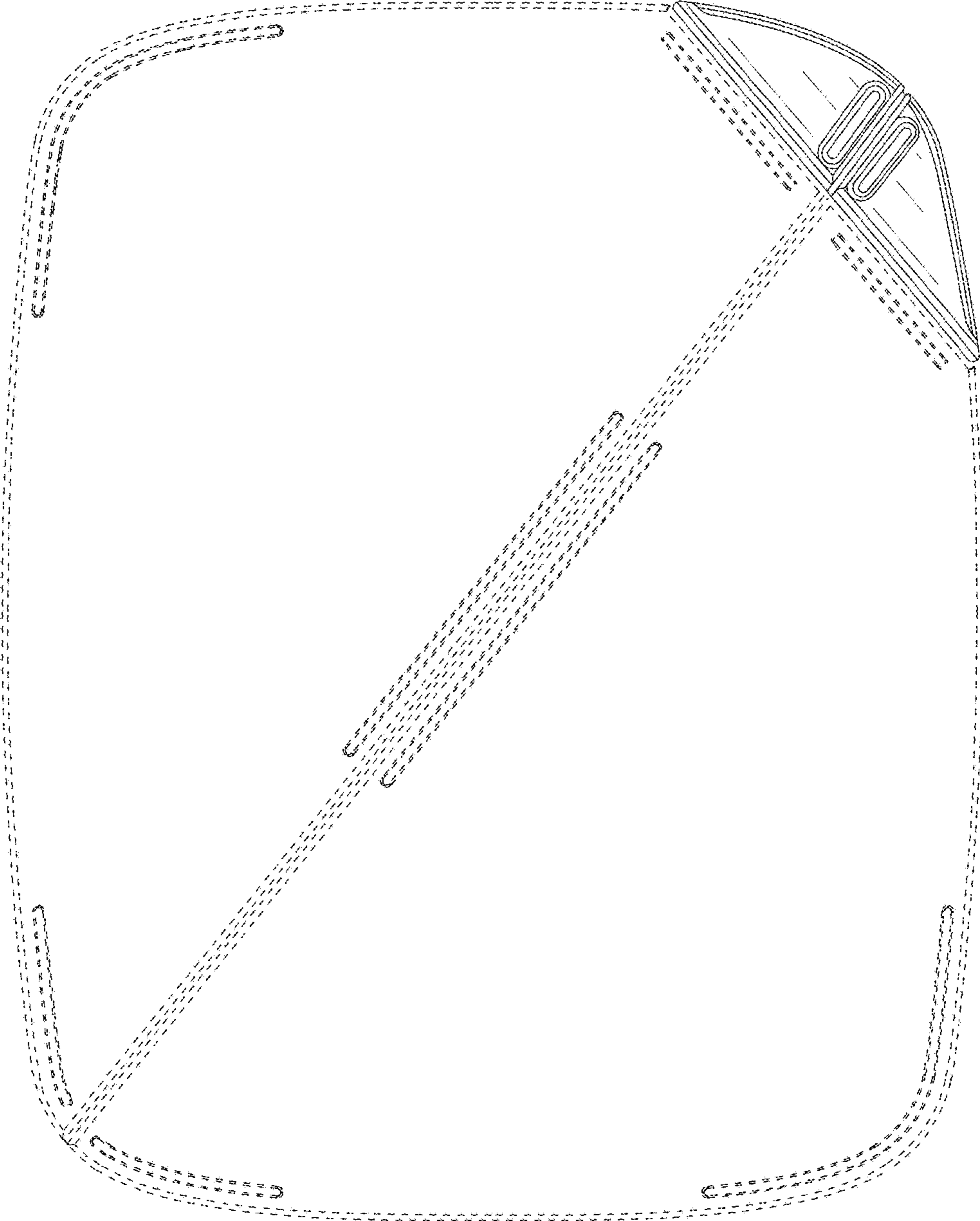

FIG. 5

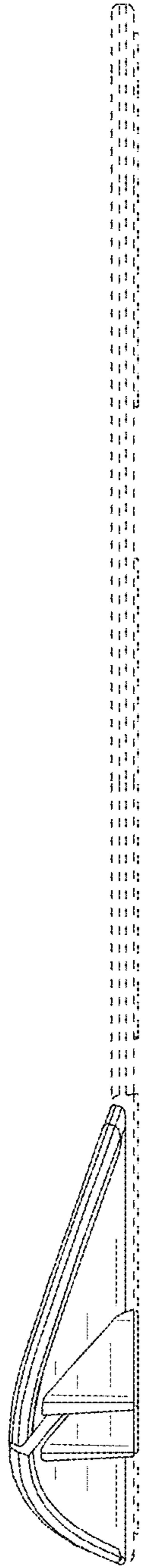

FIG. 6



FIG. 7



FIG. 8



FIG. 9