



US00D843729S

(12) **United States Design Patent**
Lacy

(10) **Patent No.:** **US D843,729 S**
(45) **Date of Patent:** **** Mar. 26, 2019**

- (54) **CHAINSAW CARRYING CASE**
- (71) Applicant: **TriLink Saw Chain, LLC**, Atlanta, GA (US)
- (72) Inventor: **Stephen B. Lacy**, Spring City, TN (US)
- (73) Assignee: **Trilink Saw Chain, LLC**, Atlanta, GA (US)
- (**) Term: **15 Years**
- (21) Appl. No.: **29/635,494**
- (22) Filed: **Jan. 31, 2018**

D684,771 S 6/2013 Leblanc
 D818,265 S * 5/2018 Hawkes D3/232
 D821,744 S * 7/2018 Armani D3/232

OTHER PUBLICATIONS

Chain Saw Accessories, Retrieved from internet: <http://www.echo-usa.com/Products/Accessories/Chain-Saw-Accessories>, Dec. 5, 2016, 22 pages.

(Continued)

Primary Examiner — Holly H Baynham
(74) *Attorney, Agent, or Firm* — Kilpatrick Townsend & Stockton LLP

Related U.S. Application Data

- (63) Continuation of application No. 29/586,687, filed on Dec. 6, 2016, now Pat. No. Des. 811,091.
- (51) **LOC (11) Cl.** **03-01**
- (52) **U.S. Cl.**
USPC **D3/318**
- (58) **Field of Classification Search**
USPC D3/318, 246, 273, 283, 321
CPC A45F 3/02; A45C 11/26; B65D 85/00; B65D 85/28
See application file for complete search history.

(57) **CLAIM**

The ornamental design for a chainsaw carrying case, as shown and described.

DESCRIPTION

FIG. 1 is a perspective front view of a chainsaw carrying case.
 FIG. 2 is a front view of the chainsaw carrying case of FIG. 1.
 FIG. 3 is a rear view of the chainsaw carrying case of FIG. 1.
 FIG. 4 is a right side view of the chainsaw carrying case of FIG. 1.
 FIG. 5 is a left side view of the chainsaw carrying case of FIG. 1.
 FIG. 6 is a top view of the chainsaw carrying case of FIG. 1; and,
 FIG. 7 is a bottom view of the chainsaw carrying case of FIG. 1.
 The broken line showing of portions of the carrying case is included for the purpose of illustrating environment and forms no part of the claimed design.

(56) **References Cited**

U.S. PATENT DOCUMENTS

D248,508 S 7/1978 Malcolm
 6,126,003 A * 10/2000 Brouard A45C 3/00
 206/372
 6,659,276 B2 12/2003 Anderson et al.
 6,823,992 B2 11/2004 Redzisz
 7,150,345 B2 12/2006 Redzisz
 7,780,051 B2 * 8/2010 Godshaw A45C 3/00
 206/372
 D641,552 S 7/2011 Sosnovsky
 D667,636 S 9/2012 Maglieri

1 Claim, 7 Drawing Sheets

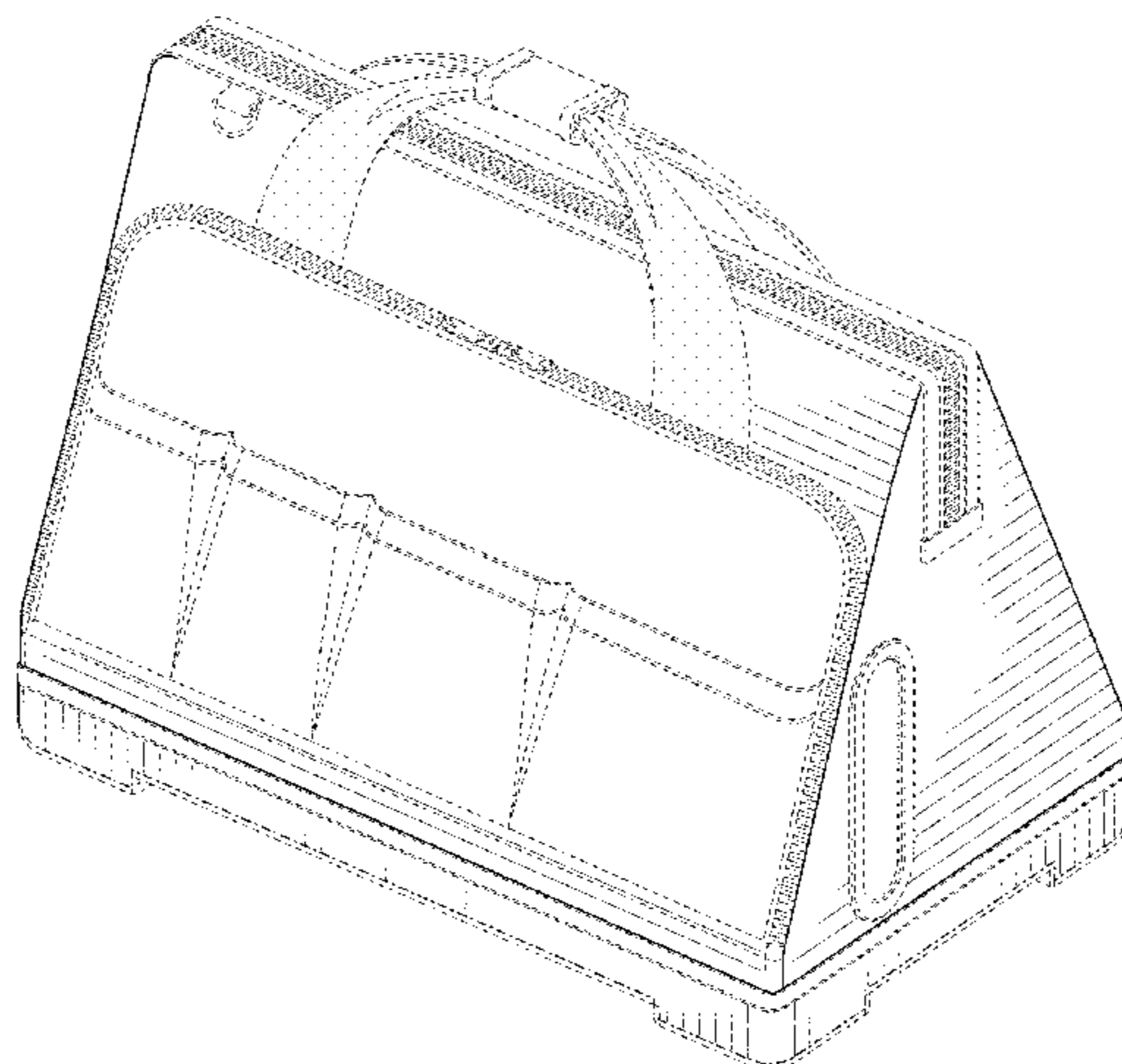

(56)

References Cited

OTHER PUBLICATIONS

Chainsaw Cases and Bags, Retrieved from internet:<http://www.husqvarna.com/us/accessories/chainsaw-bags-boxes/chainsaw-bag/576859101/>, 2016, believed to be publicly available as early as Aug. 5, 2016, Dec. 5, 2016, 4 pages.

Classic Carry Case US, Retrieved from internet :<http://www.husqvarna.com/us/accessories/chainsaw-bags-boxes/classic-carry-case-us/100000101/>, Dec. 5, 2016, 2 pages.

Motosierra Husqvarna Bolsa P/N 505690095 [193512], Retrieved from internet: <http://www.ebay.es/itm/Husqvarna-Chainsaw-Bag-p-n-505690095-193512-/252316815064>, Dec. 5, 2016, 2 pages.

Oregon PowerNow Chainsaw Carrying Case, Retrieved from internet: <https://www.ombwarehouse.com/Oregon-PowerNow-Chainsaw-Carrying-Case.html>, Dec. 5, 2016, 7 pages.

“U.S Appl. No. 29/586,687, Notice of Allowance”, dated Oct. 20, 2017, 12 pages.

* cited by examiner

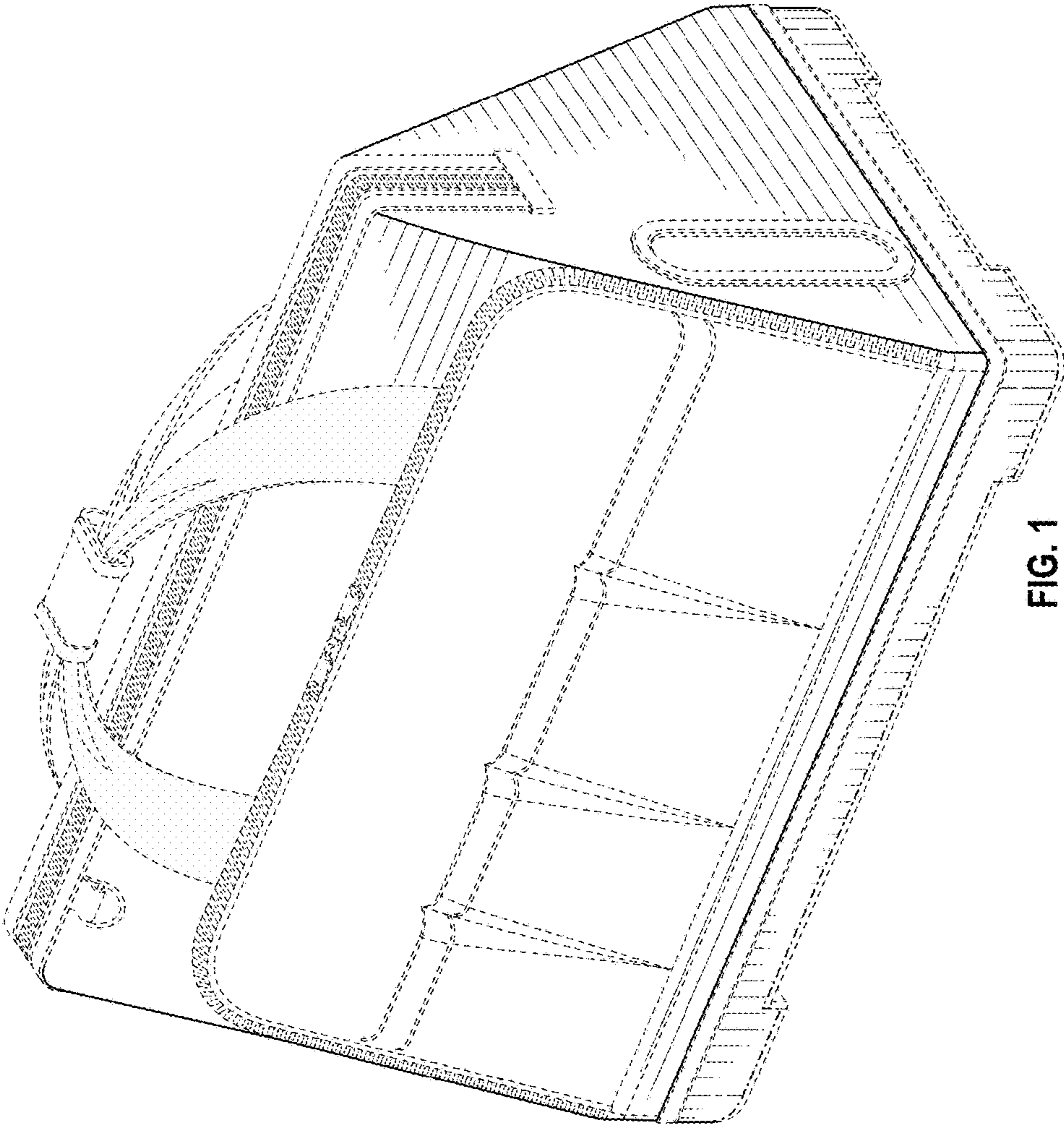

FIG. 1

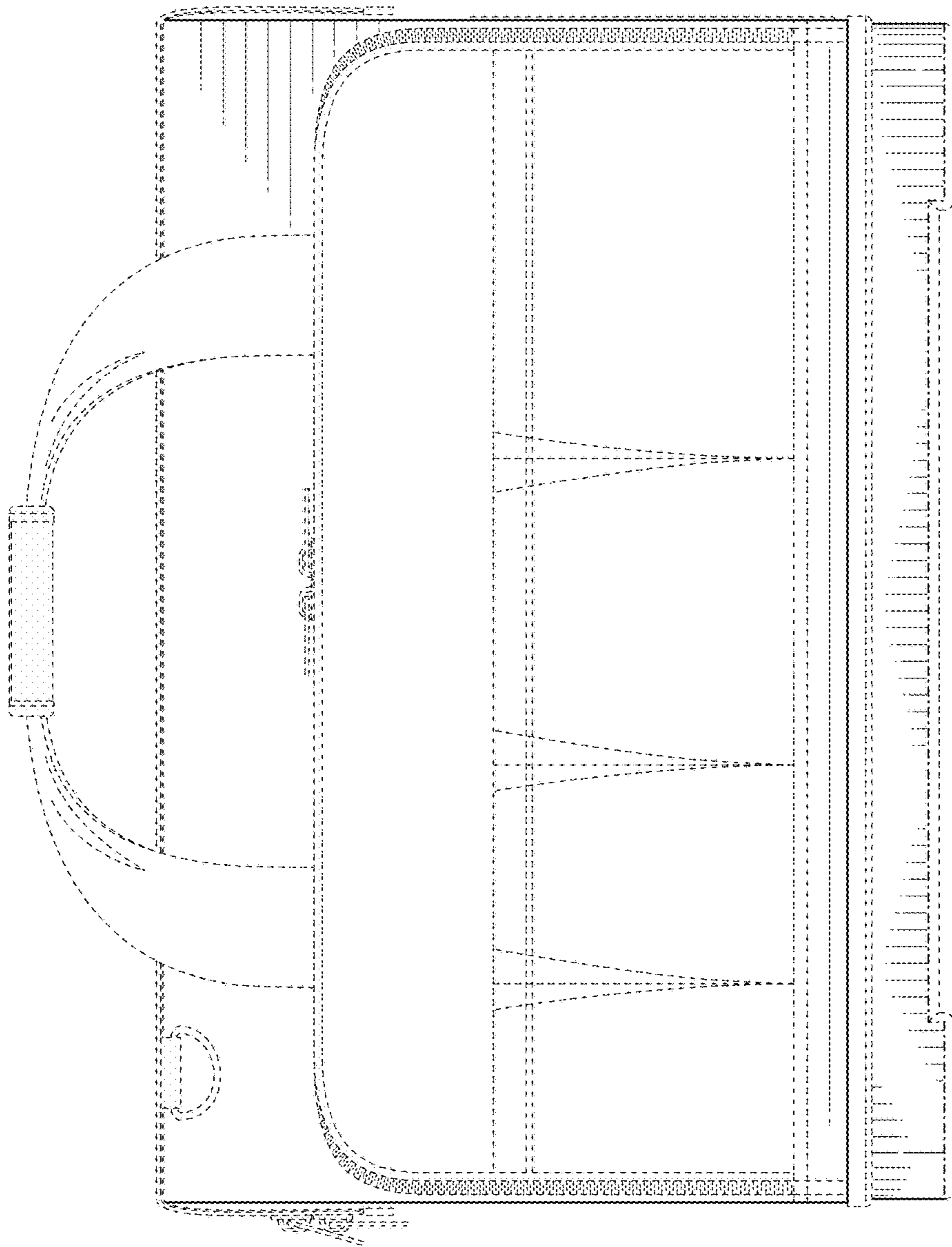

FIG. 2

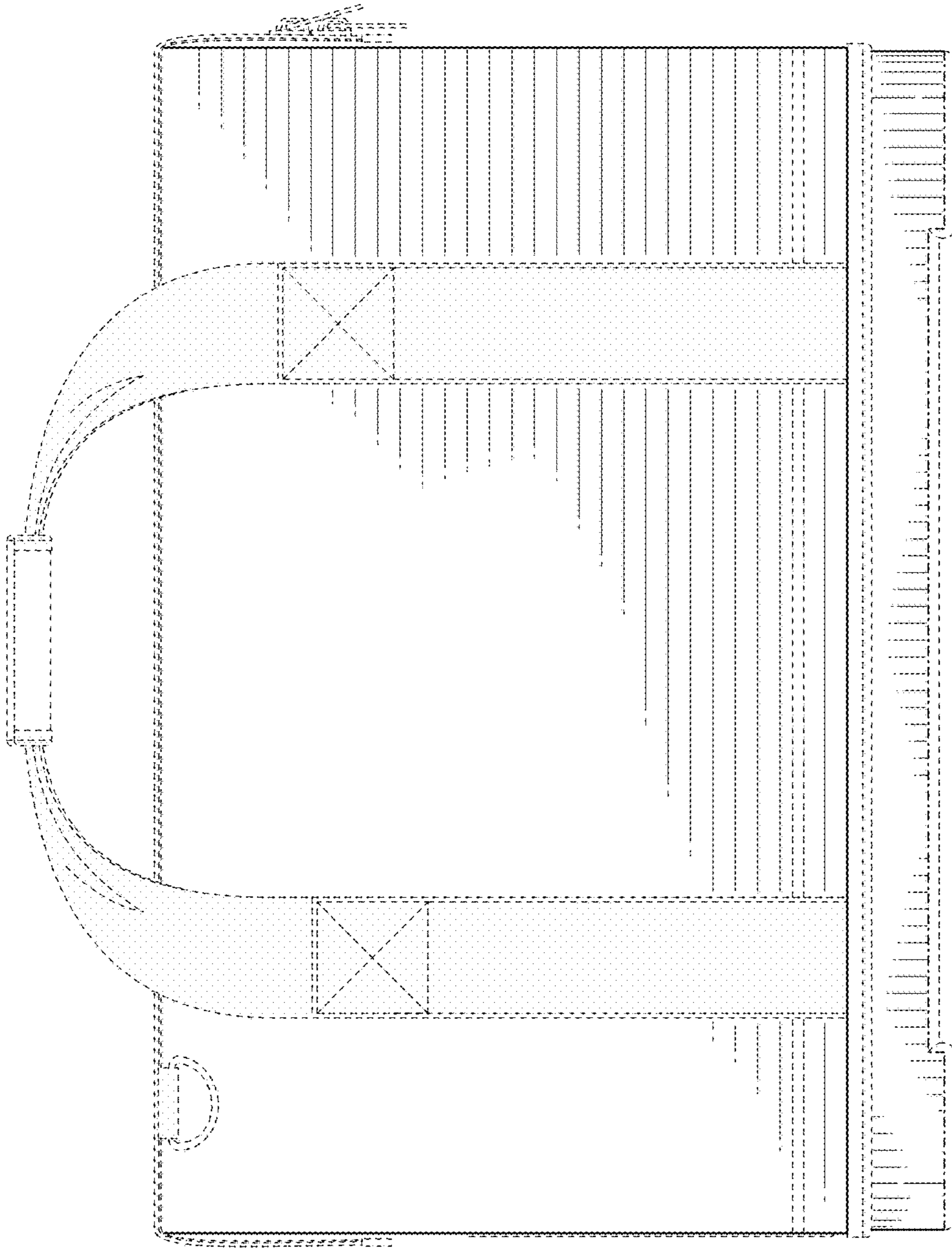

FIG. 3

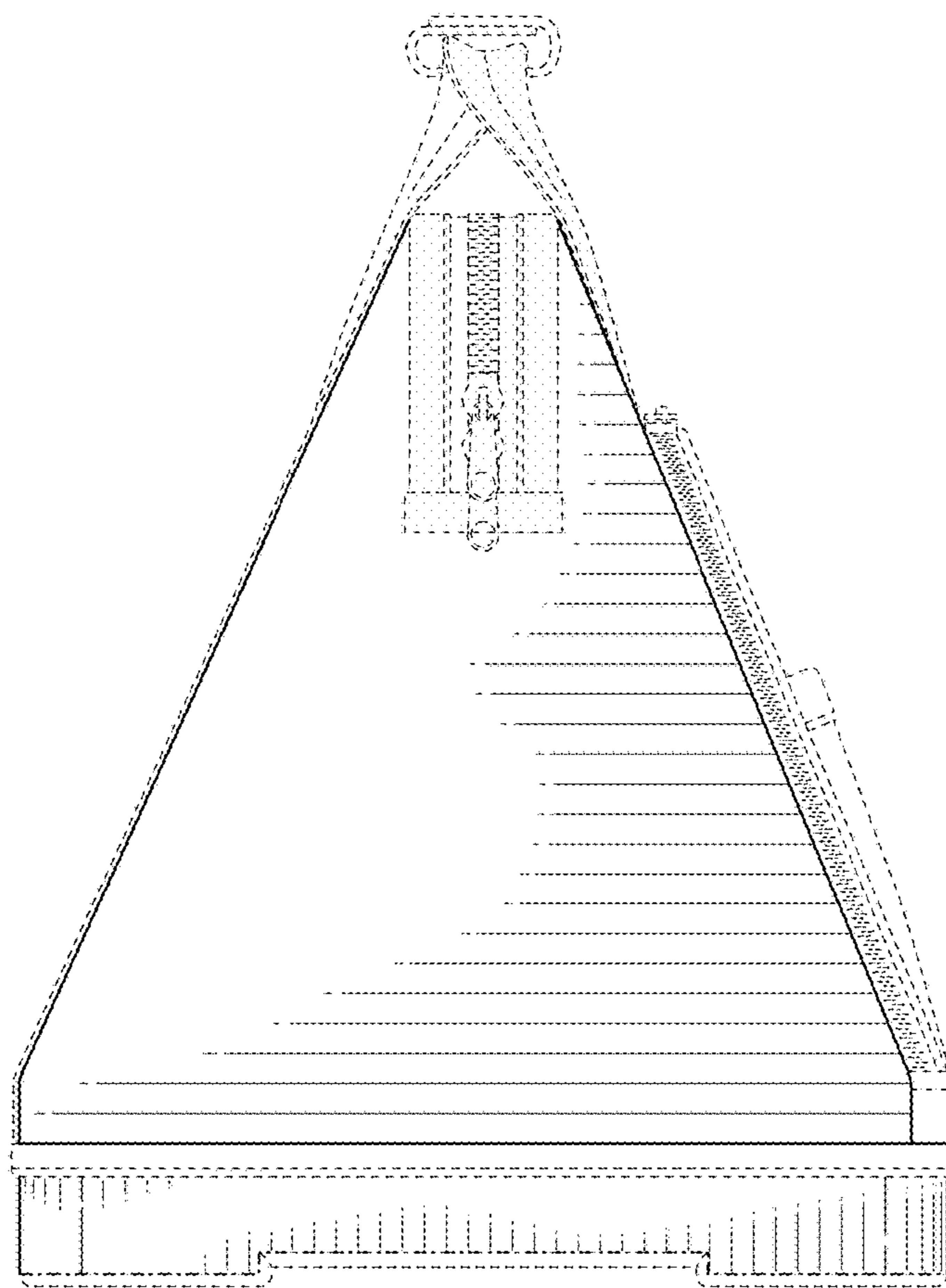

FIG. 4

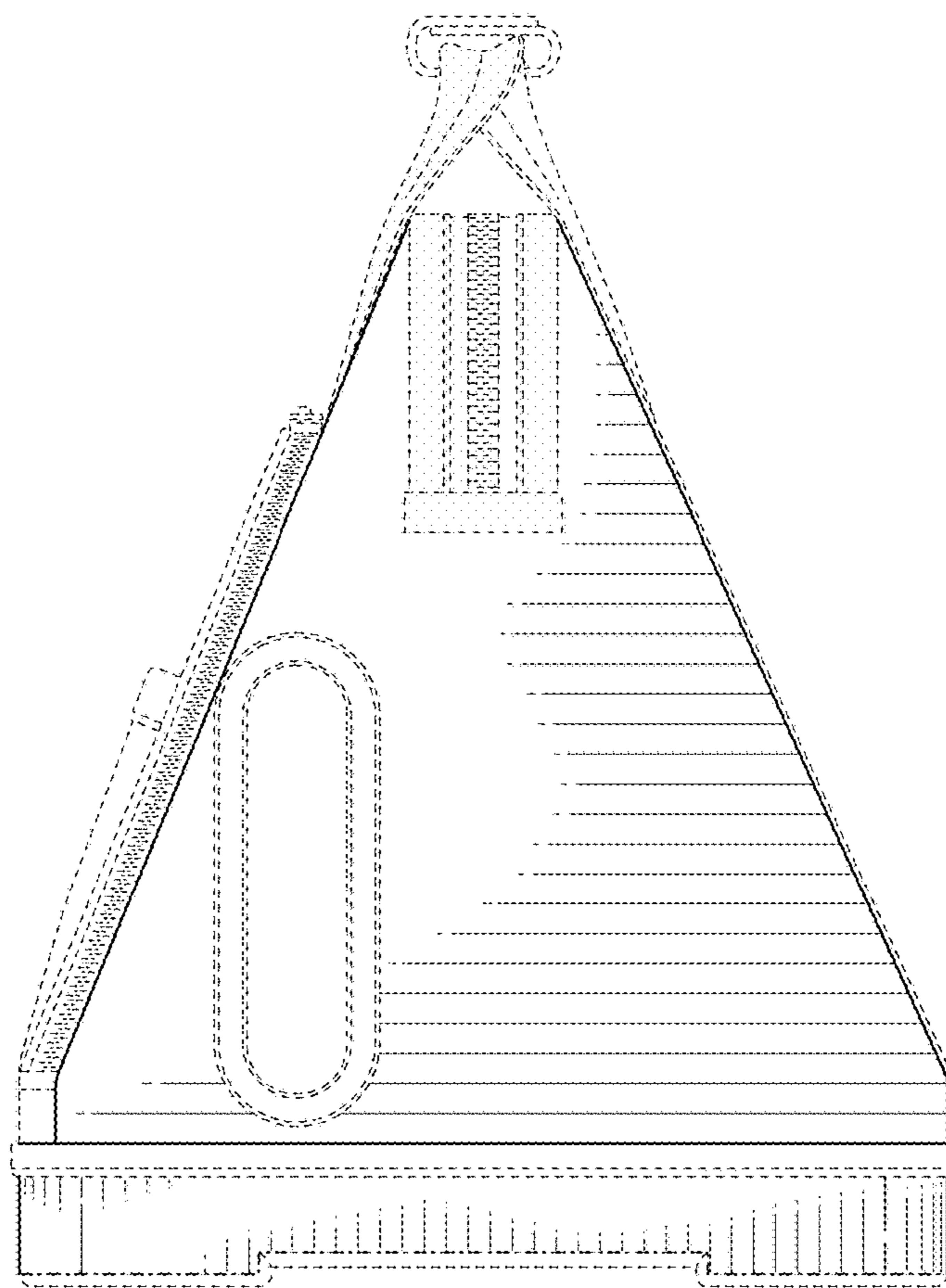

FIG. 5

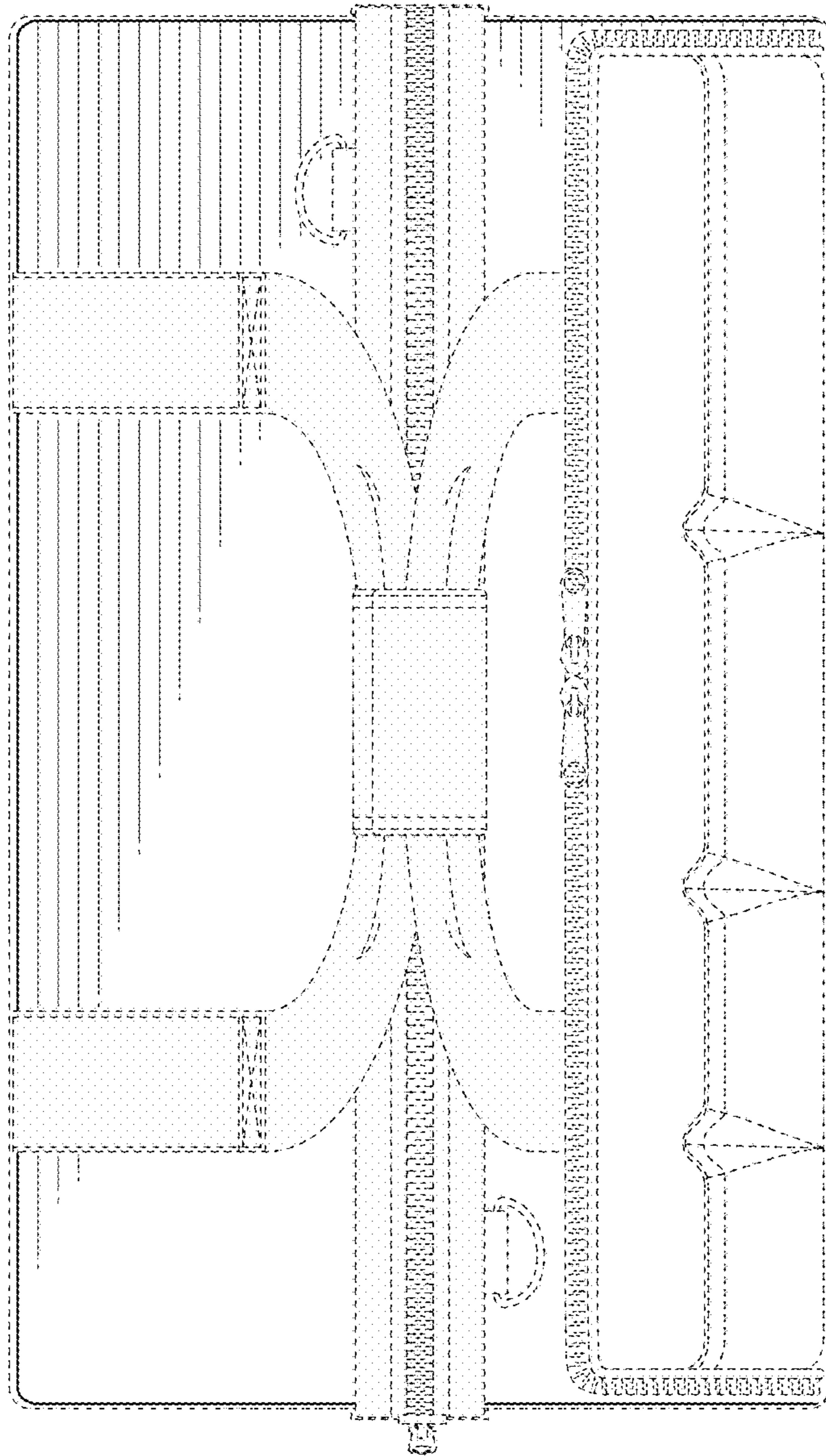

FIG. 6

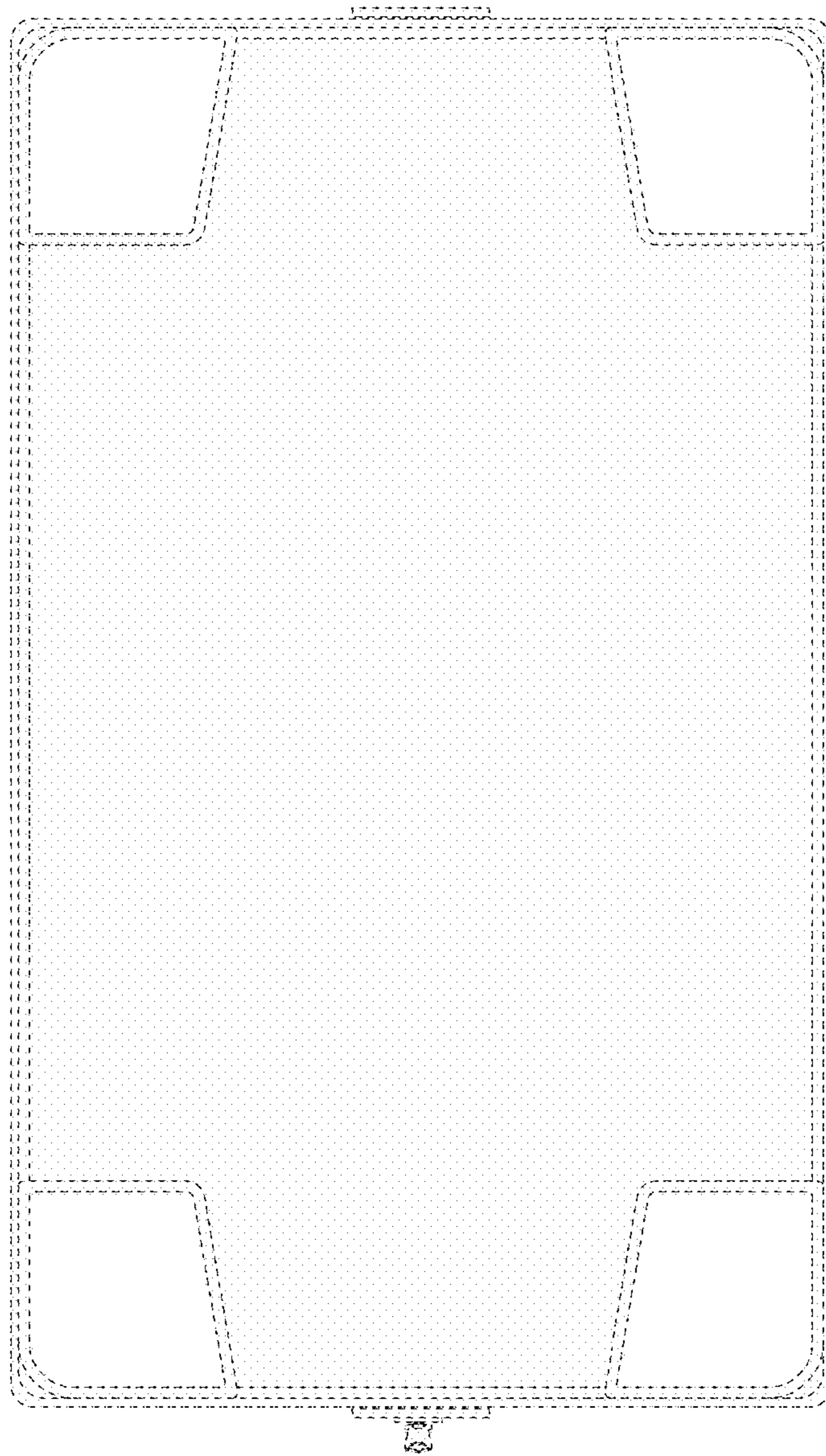

FIG. 7