



US00D843653S

(12) **United States Design Patent**  
**Teyu et al.**

(10) **Patent No.:** **US D843,653 S**  
(45) **Date of Patent:** **\*\* Mar. 19, 2019**

(54) **SUPPORT FOR A HAIR CARE APPLIANCE**

(71) Applicant: **Dyson Technology Limited**, Wiltshire (GB)

(72) Inventors: **Mon Shy Teyu**, Johor Bahru (MY);  
**Paul Andrew McLuckie**, Bristol (GB);  
**Alexander Stuart Knox**, Swindon (GB);  
**Stephen Benjamin Courtney**, Gloucester (GB);  
**William John Darvill**, Singapore (SG)

(73) Assignee: **Dyson Technology Limited**, Malmesbury, Wiltshire (GB)

(\*\*) Term: **15 Years**

(21) Appl. No.: **29/618,534**

(22) Filed: **Sep. 21, 2017**

(30) **Foreign Application Priority Data**

Mar. 22, 2017 (GB) ..... 6009491

(51) **LOC (11) Cl.** ..... **28-03**

(52) **U.S. Cl.**  
USPC ..... **D28/18**

(58) **Field of Classification Search**

USPC ..... D28/10, 12, 13, 14, 15, 16, 17, 18, 20,  
D28/81, 82, 83, 84

CPC ..... A45D 20/00; A45D 20/48; A45D 20/50;  
A45D 20/52; A45D 20/525; A45D 20/04;  
A45D 20/08; A45D 20/10; A45D 20/12;  
A45D 20/122; A45D 44/08; A45D  
2019/005; A45D 2019/0058; A45D 19/04;  
A45D 19/06; A45D 19/08; A45D 19/12;  
A45D 40/00; A45D 40/18; A45D  
40/0087; A45D 40/222; A45D 40/0093;  
A45D 33/00; A45D 33/006; A45D  
33/025; A45D 33/008; A45D 33/003;  
A45D 33/18; A45D 2040/225; A45D  
2034/007

See application file for complete search history.

(56) **References Cited**

U.S. PATENT DOCUMENTS

5,590,475 A \* 1/1997 Andis ..... A45D 20/12  
34/90  
D378,892 S \* 4/1997 Garcia ..... D28/73  
(Continued)

OTHER PUBLICATIONS

Dyson Supersonic™ White/Silver with Presentation Stand, posted © 2017 [online], retrieved Oct. 9, 2018, retrieved from internet, <<https://www.metro.com.sg/product/dyson-supersonic-hair-dryer-whitesilver-with-metal-stand?r=c-5556>>.\*

(Continued)

*Primary Examiner* — Barbara Fox

*Assistant Examiner* — Messina L Smith

(74) *Attorney, Agent, or Firm* — Morrison & Foerster LLP

(57) **CLAIM**

We claim the ornamental design for a support for a hair care appliance, as shown and described.

**DESCRIPTION**

FIG. 1 is a front perspective view of a support for a hair care appliance showing our new design;

FIG. 2 is a rear perspective view thereof;

FIG. 3 is a side view thereof;

FIG. 4 is a front view thereof;

FIG. 5 is a rear view thereof;

FIG. 6 is a top view thereof; and,

FIG. 7 is a bottom view thereof.

The view opposite the side view of FIG. 3 is a mirror image of the side view of FIG. 3 and, therefore, is omitted herein. The broken lines shown in the drawings illustrate portions of a support for a hair care appliance that form no part of the claimed design.

**1 Claim, 7 Drawing Sheets**

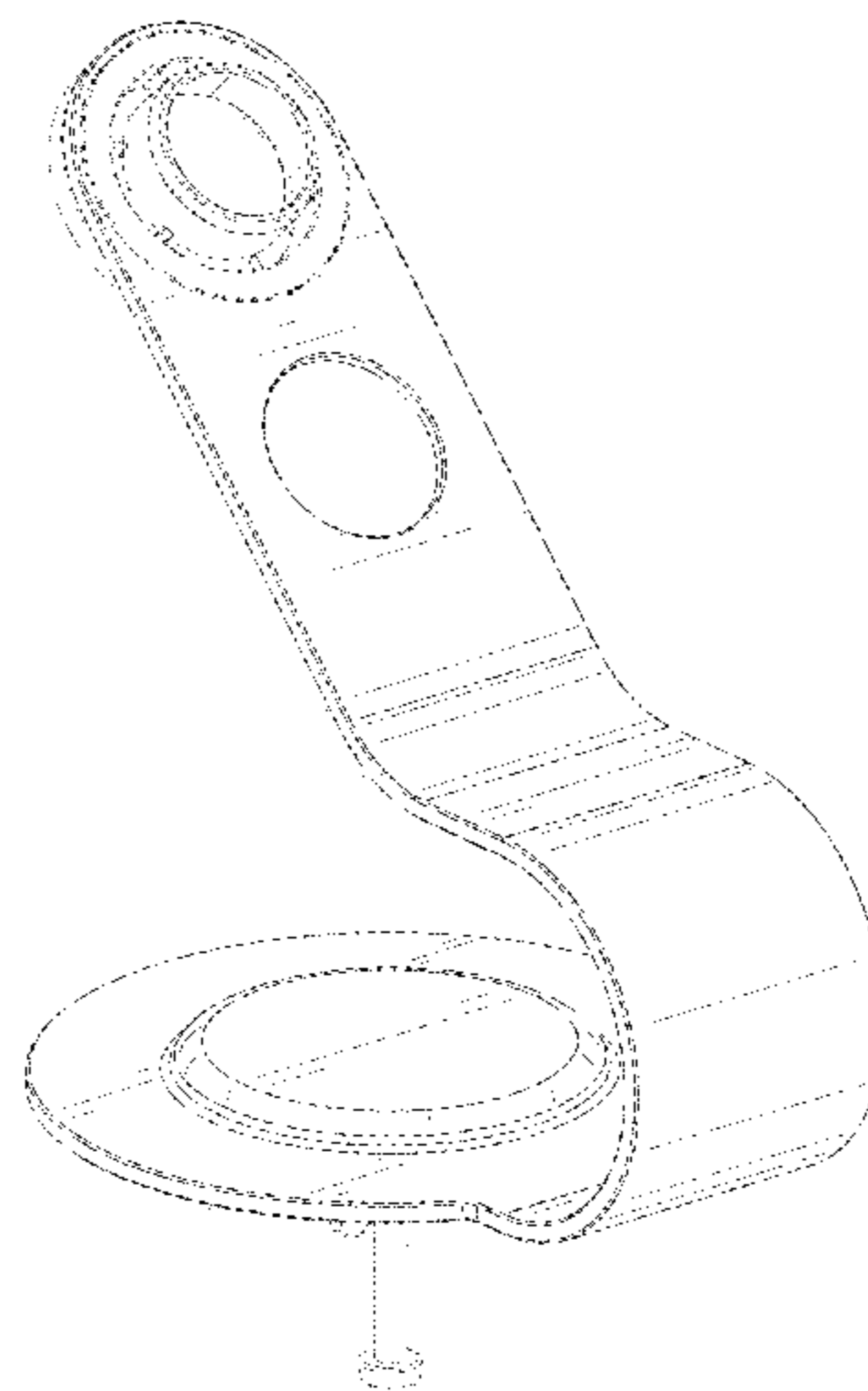
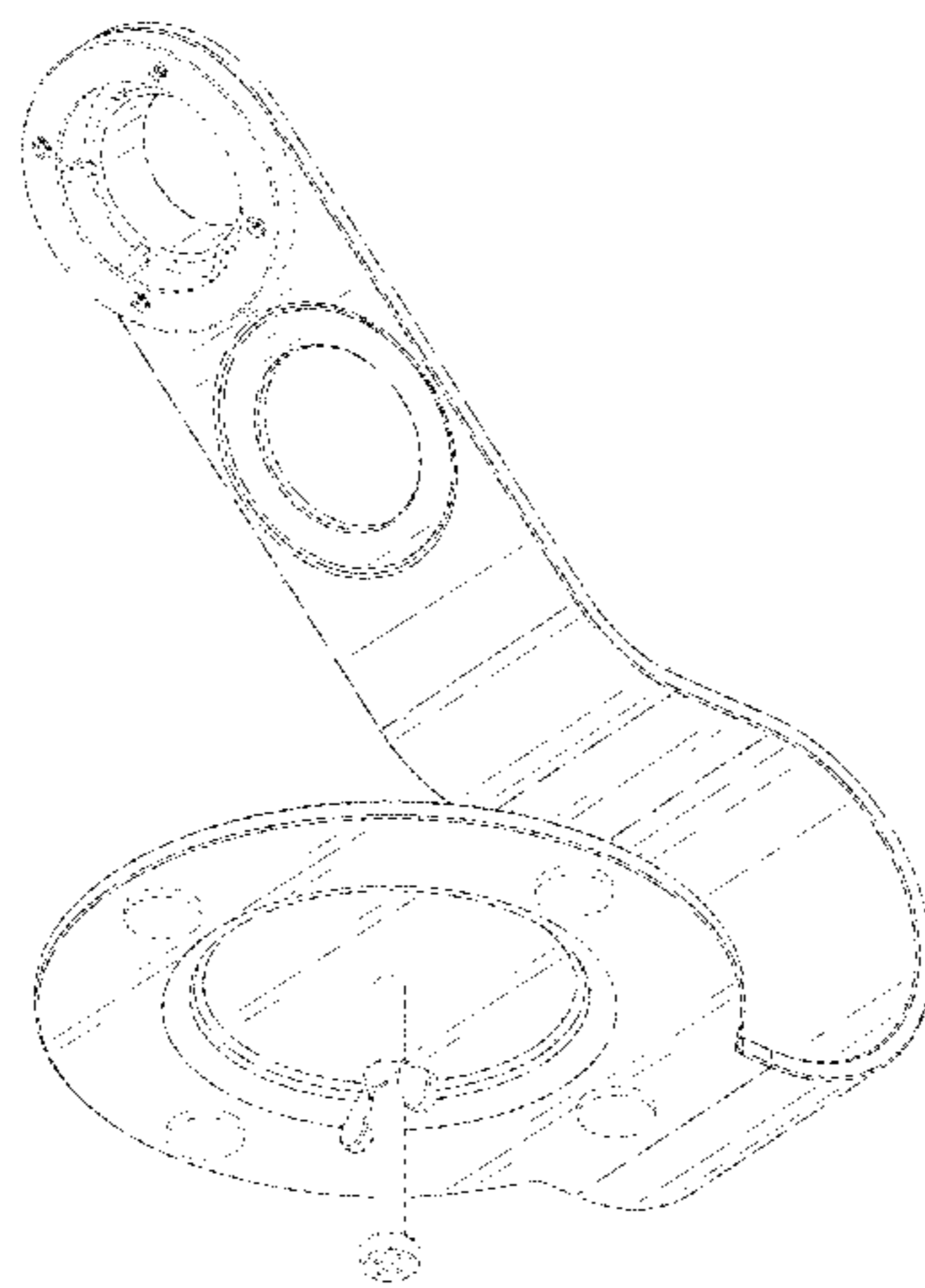

(56)

**References Cited**

U.S. PATENT DOCUMENTS

7,506,849 B1 \* 3/2009 Koster ..... A45D 20/12  
248/214  
D601,300 S \* 9/2009 Burk ..... D28/18  
7,748,583 B1 \* 7/2010 Woltman ..... A45D 20/12  
224/242  
D645,462 S \* 9/2011 Choi ..... D14/253  
D669,636 S \* 10/2012 Goodman ..... D28/38  
D717,289 S \* 11/2014 Takabatake ..... D14/252  
D748,334 S \* 1/2016 Goodman ..... D28/38  
D752,595 S \* 3/2016 Heckler ..... D14/447  
D769,235 S \* 10/2016 Li ..... D14/253  
D806,436 S \* 1/2018 Bartolomucci ..... D6/546  
9,968,188 B1 \* 5/2018 Floersch ..... A47B 23/04  
D828,843 S \* 9/2018 Foldvary ..... D14/447  
2004/0065688 A1 \* 4/2004 Duquet ..... A45D 37/00  
222/215  
2011/0057082 A1 \* 3/2011 West ..... A45D 20/12  
248/222.14

OTHER PUBLICATIONS

Dyson Supersonic™ hair dryer stand, no posting date given [online],  
retrieved Oct. 9, 2018, retrieved from internet, <<https://shop.dyson.com.sg/haircare/dyson-supersonic-hair-dryer-stand-968685-02>>.\*

\* cited by examiner

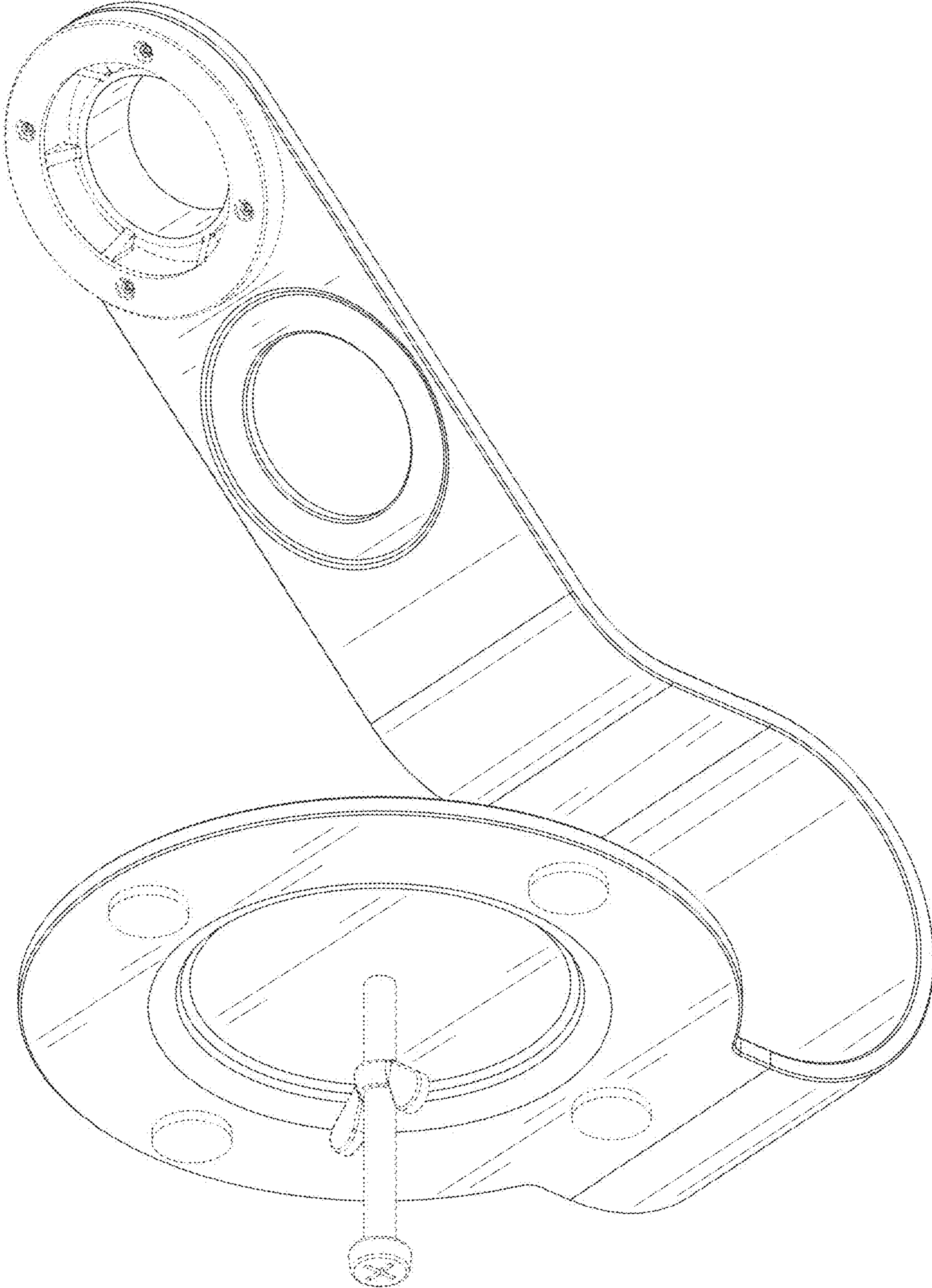

FIG. 1

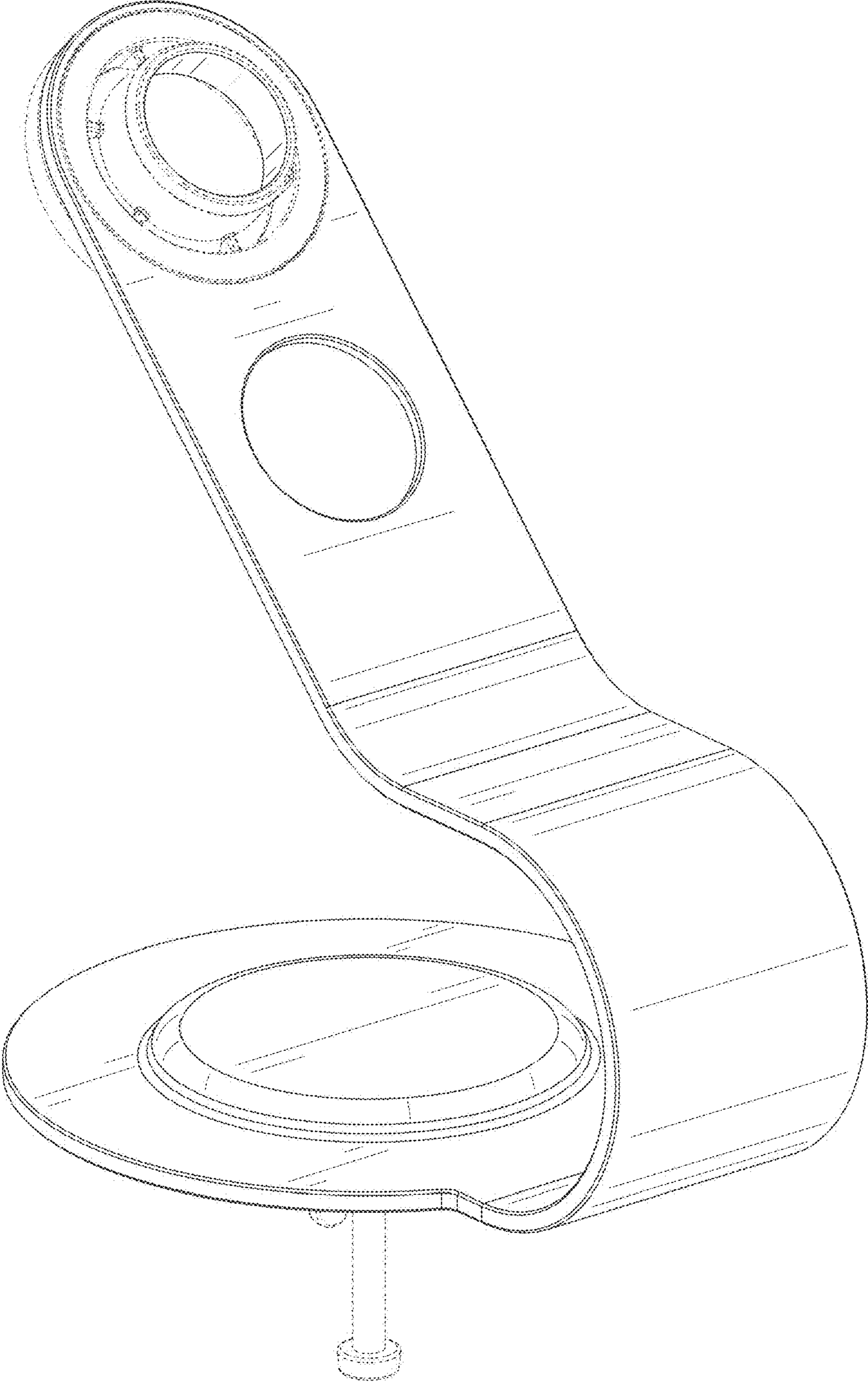

FIG. 2

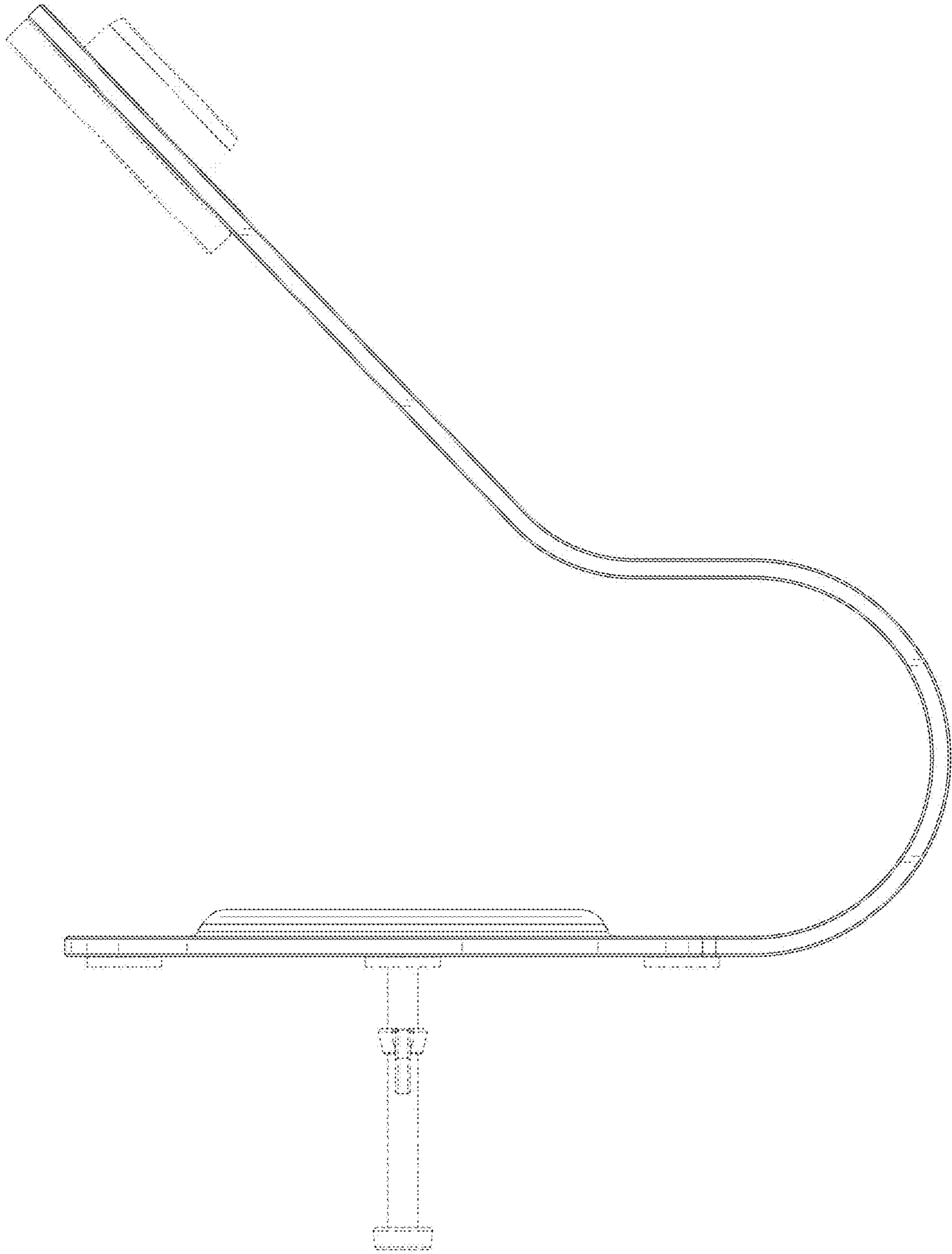

FIG. 3

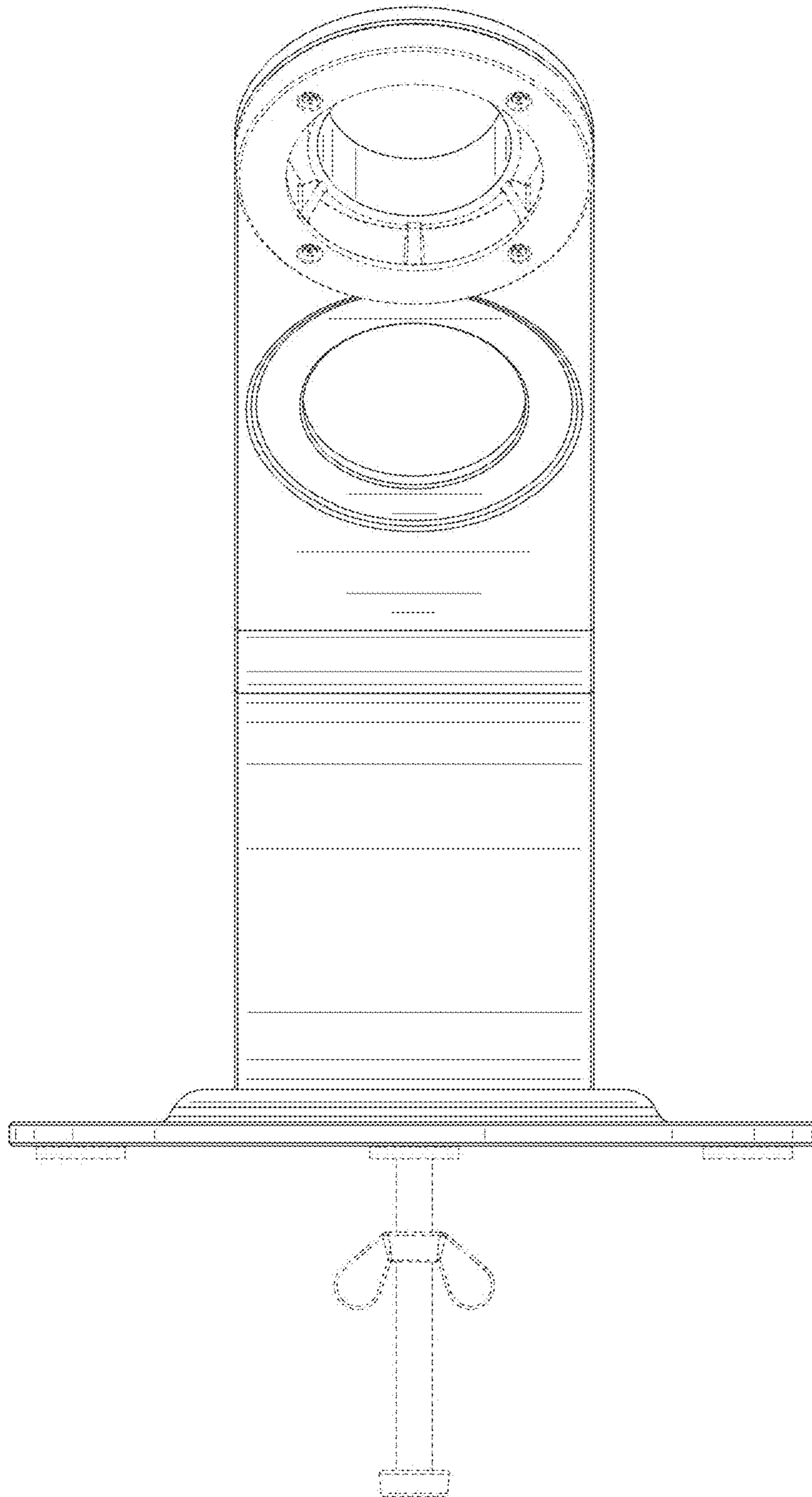

FIG. 4

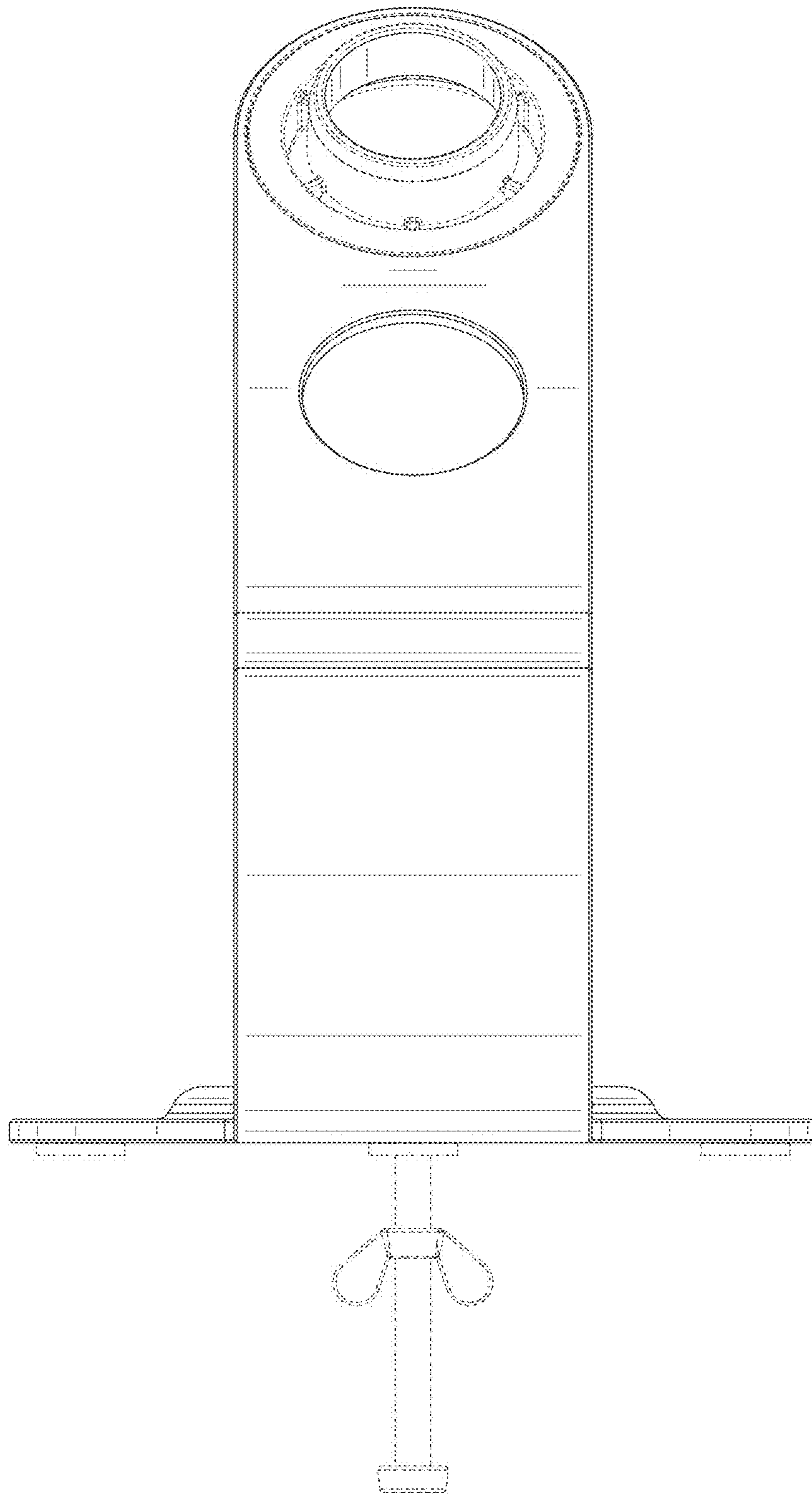

FIG. 5

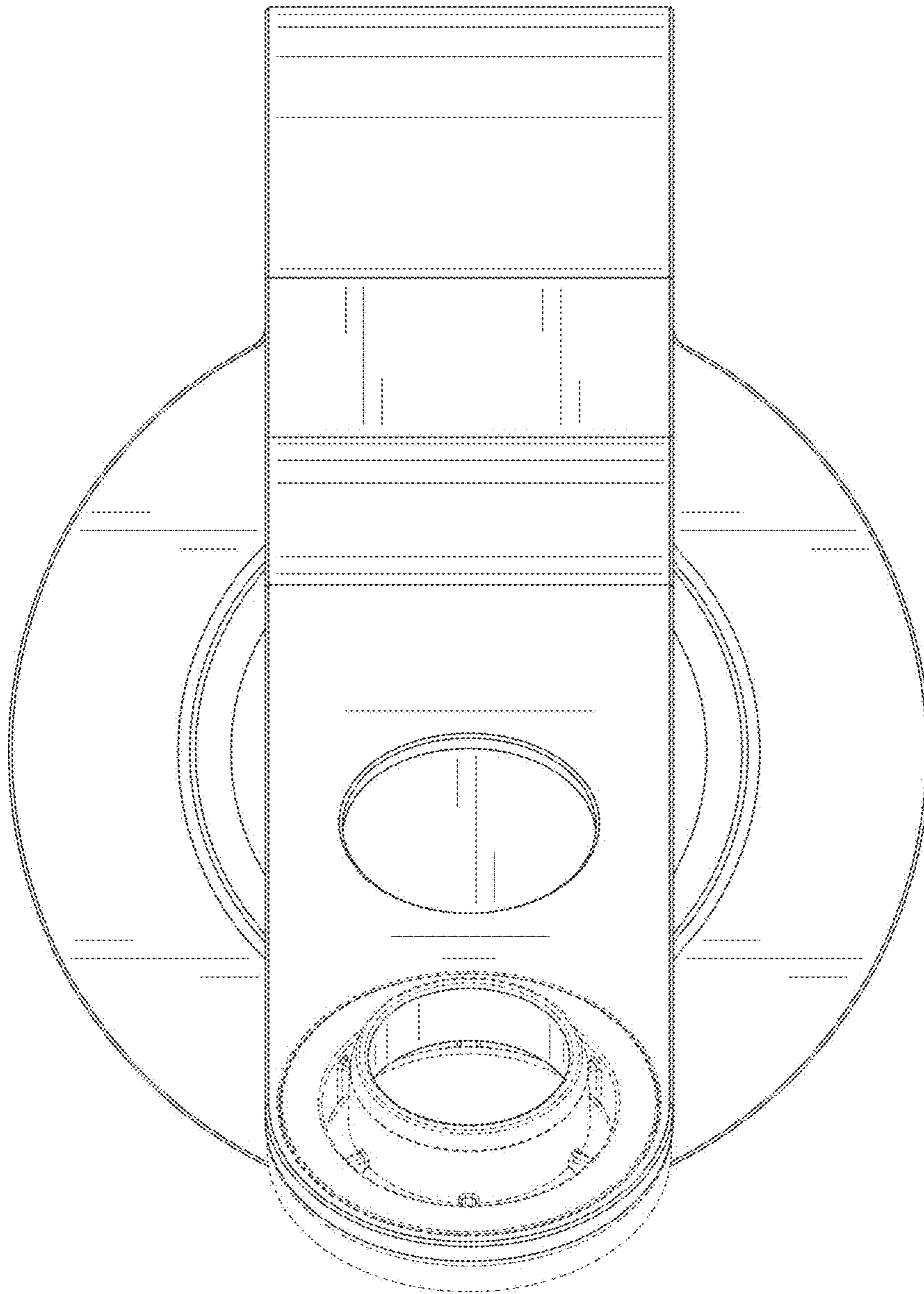

FIG. 6



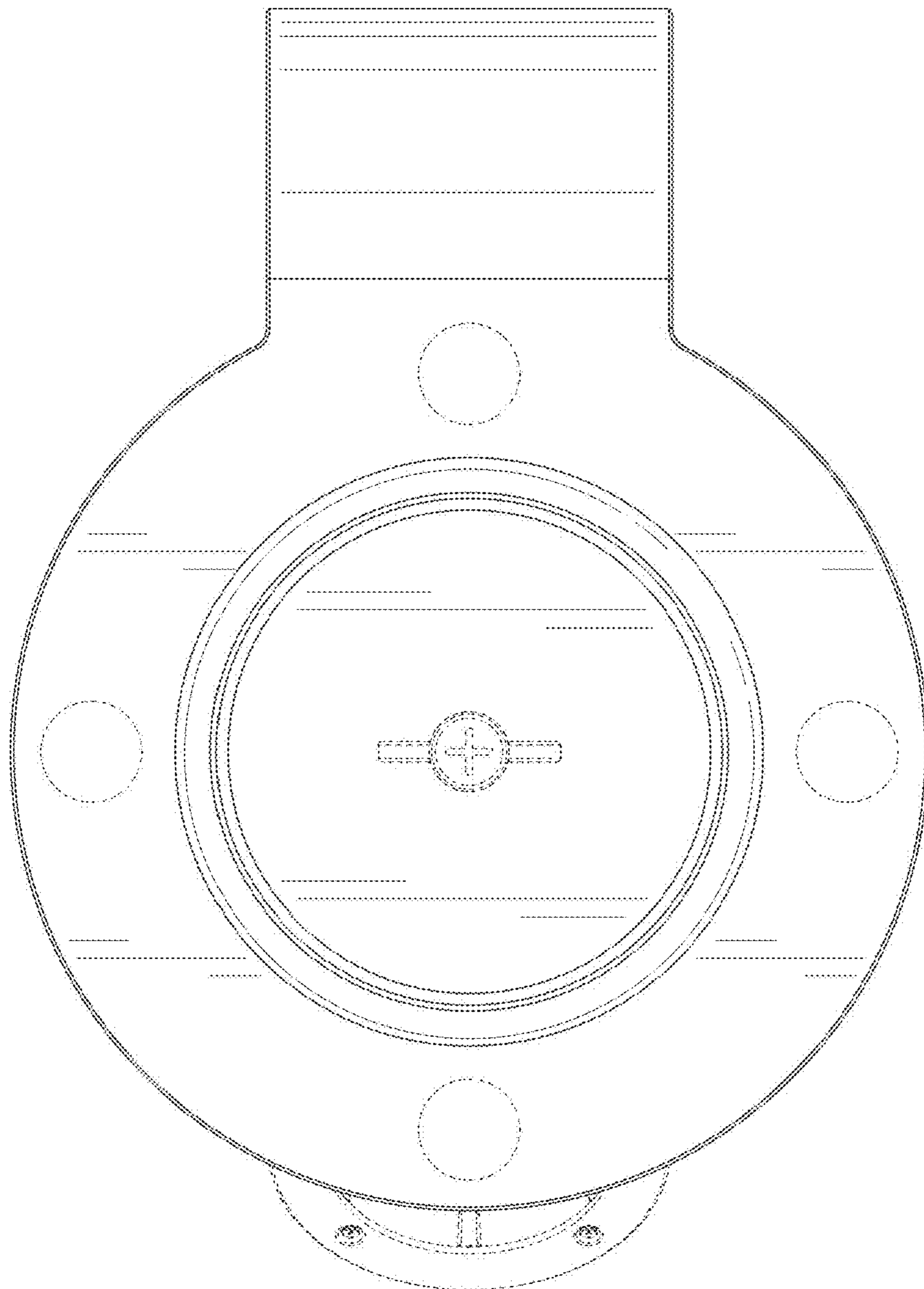

FIG. 7