



US00D843588S

(12) **United States Design Patent**
Slowey

(10) **Patent No.:** **US D843,588 S**

(45) **Date of Patent:** **** Mar. 19, 2019**

(54) **COMBINED MULTIPURPOSE ADHESIVE
BANDAGE AND SPLINT DEVICE**

(71) Applicant: **Timothy John Slowey**, North
Attleboro, MA (US)

(72) Inventor: **Timothy John Slowey**, North
Attleboro, MA (US)

(**) Term: **15 Years**

(21) Appl. No.: **29/625,710**

(22) Filed: **Nov. 13, 2017**

(51) **LOC (11) Cl.** **24-04**

(52) **U.S. Cl.**
USPC **D24/189**

(58) **Field of Classification Search**
USPC D24/124–128, 132, 133, 185–193, 199,
D24/200, 206, 209, 210, 212–215;
D29/100, 108, 121.1, 121.2; D30/146
(Continued)

(56) **References Cited**

U.S. PATENT DOCUMENTS

2,280,506 A * 4/1942 Betts A61F 13/0203
128/894
4,614,183 A * 9/1986 McCracken A61F 13/023
128/846

(Continued)

OTHER PUBLICATIONS

Health Products for You. Tapeless Medical Great Finger Toe Non Adhesive Dressing Holder. Aug. 2018 [earliest online date], [site visited Aug. 8, 2018]. Available from Internet, <URL:https://www.healthproductsforyou.com/p-tapeless-medical-great-finger-toe-dressing-holder.html>. (Year: 2018).*

Primary Examiner — George D. Kirschbaum

Assistant Examiner — Darcey E Heflin

(74) *Attorney, Agent, or Firm* — Ashok Tankha; Lipton,
Weinberger & Husick

(57) **CLAIM**

The ornamental design for a combined multipurpose adhesive bandage and splint device, as shown and described.

DESCRIPTION

FIG. 1 is a front perspective view of an ornamental design for a combined multipurpose adhesive bandage and splint device with three peel-off protective films; FIG. 2 is a rear perspective view thereof; FIG. 3 is a front elevation view thereof; FIG. 4 is a rear elevation view thereof; FIG. 5 is a right side elevation view thereof; FIG. 6 is a left side elevation view thereof; FIG. 7 is a top plan view thereof; FIG. 8 is a bottom view thereof; FIG. 9 is a front perspective view thereof, with one peel-off protective film removed; FIG. 10 is a front perspective view thereof, with two peel-off protective films removed; FIG. 11 is a front perspective view thereof, with three peel-off protective films removed, exposing a splint; FIG. 12 is a front elevation view thereof, with the three peel-off protective films removed; FIG. 13 is a right side elevation view thereof, with the three peel-off protective films removed; FIG. 14 is a left side elevation view thereof, with the three peel-off protective films removed; FIG. 15 is a top plan view thereof, with the three peel-off protective films removed; FIG. 16 is a bottom view thereof, with the three peel-off protective films removed; FIG. 17 is a perspective view of the multipurpose adhesive bandage and splint device placed over a wounded area of an extended elbow of an arm of a user; FIG. 18 is a perspective view of the multipurpose adhesive bandage and splint device wrapped around the wounded area of the extended elbow of the arm of the user; and, FIG. 19 is a perspective view of the multipurpose adhesive bandage and splint device wrapped around a wounded area of a finger of a hand of the user.

(Continued)

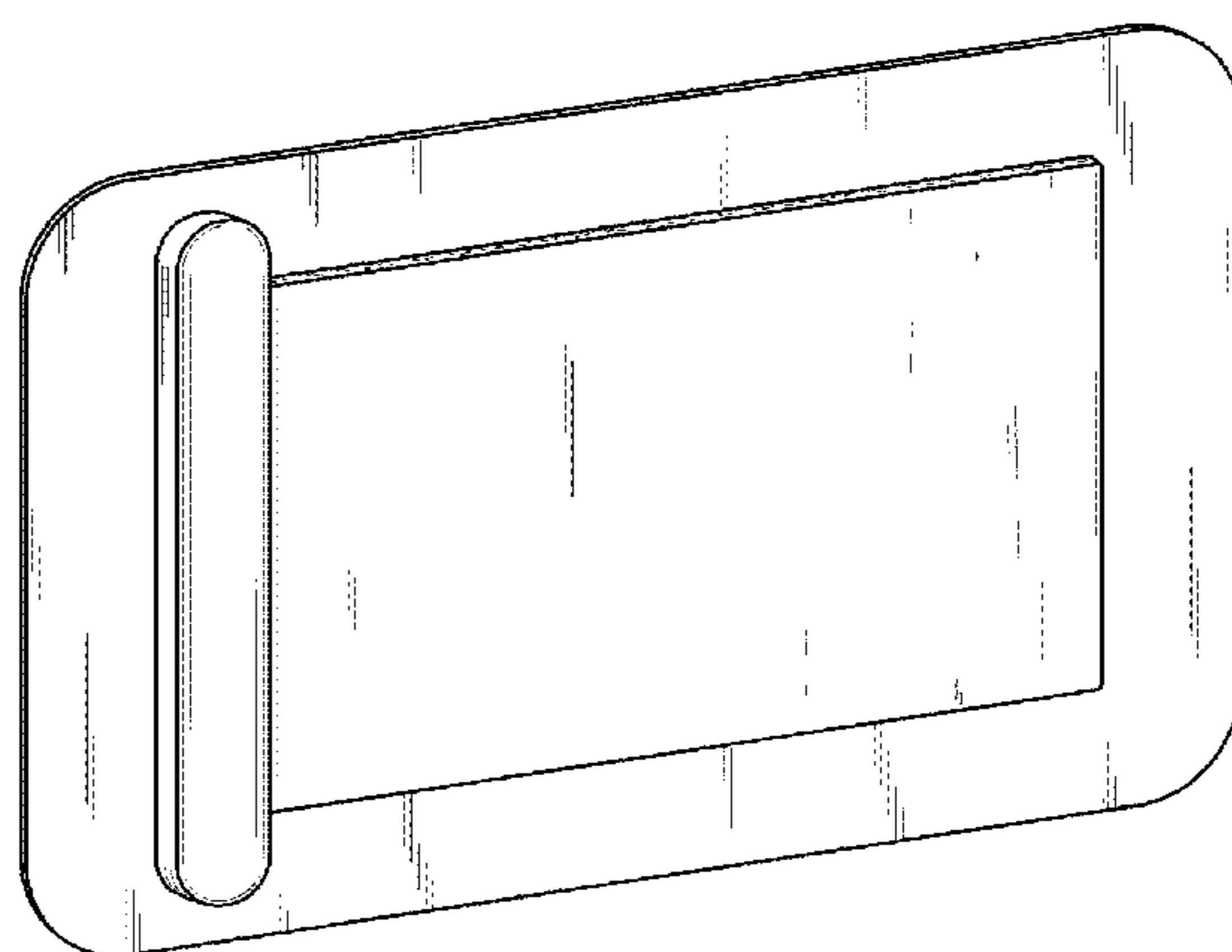
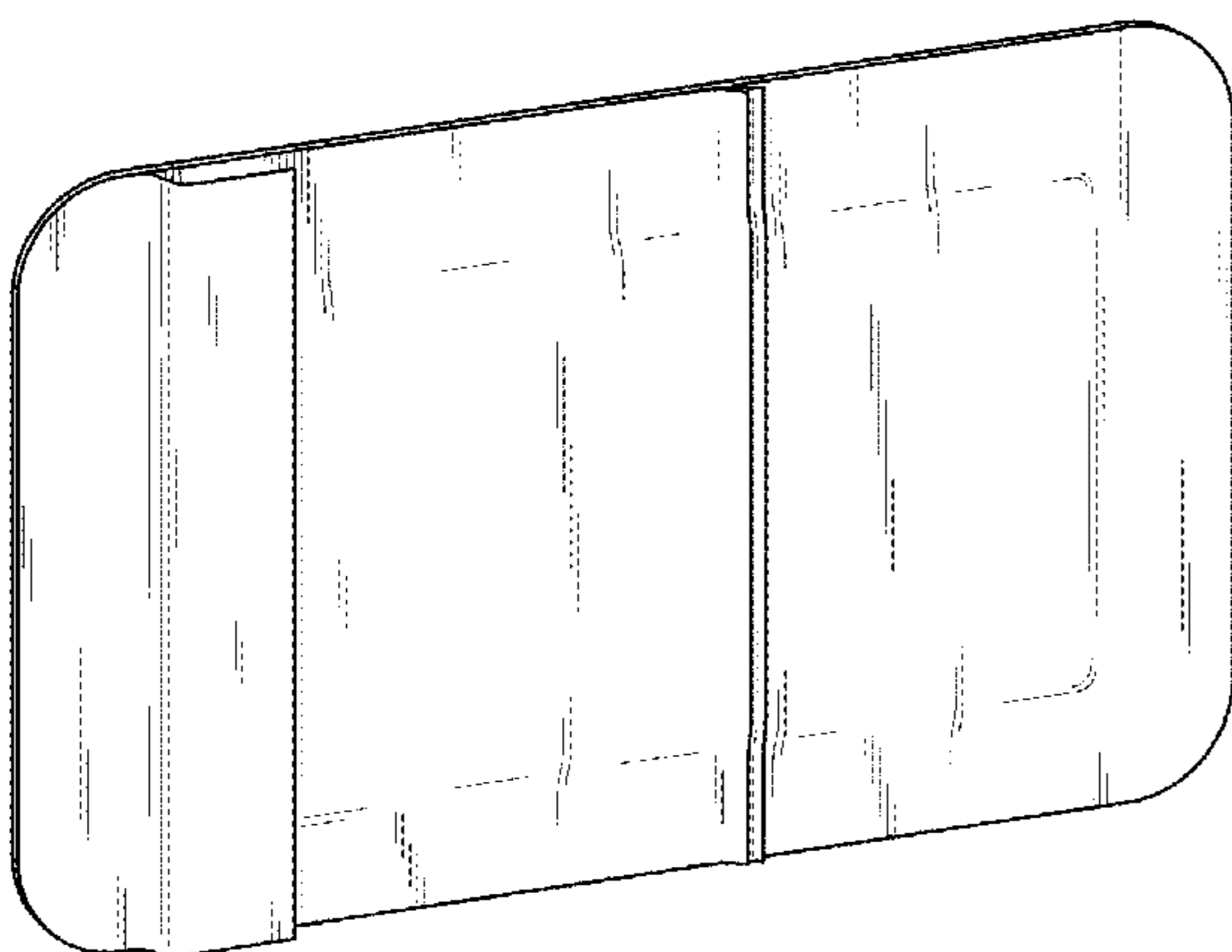

The broken line showing of the arm with the extended elbow and the hand with the fingers of the user in FIGS. 17-19 is for the purpose of illustrating environment and forms no part of the claimed design.

1 Claim, 15 Drawing Sheets

(58) **Field of Classification Search**

CPC A61F 13/023; A61F 15/008; A61F 15/004;
A61F 2013/00646; A61M 2025/0246
See application file for complete search history.

(56) **References Cited**

U.S. PATENT DOCUMENTS

4,744,355	A *	5/1988	Faasse, Jr.	A61F 13/023 602/52
5,012,801	A *	5/1991	Feret	A61F 13/023 128/888
D515,701	S *	2/2006	Horhota	D24/189
D535,032	S *	1/2007	Bendjy	D24/189
D545,441	S *	6/2007	Miyachika	D24/189
D686,734	S *	7/2013	Tsuruta	D24/189
D686,735	S *	7/2013	Tsuruta	D24/189
D692,151	S *	10/2013	Inoo	D24/189
D792,977	S *	7/2017	Riesinger	D24/189

* cited by examiner

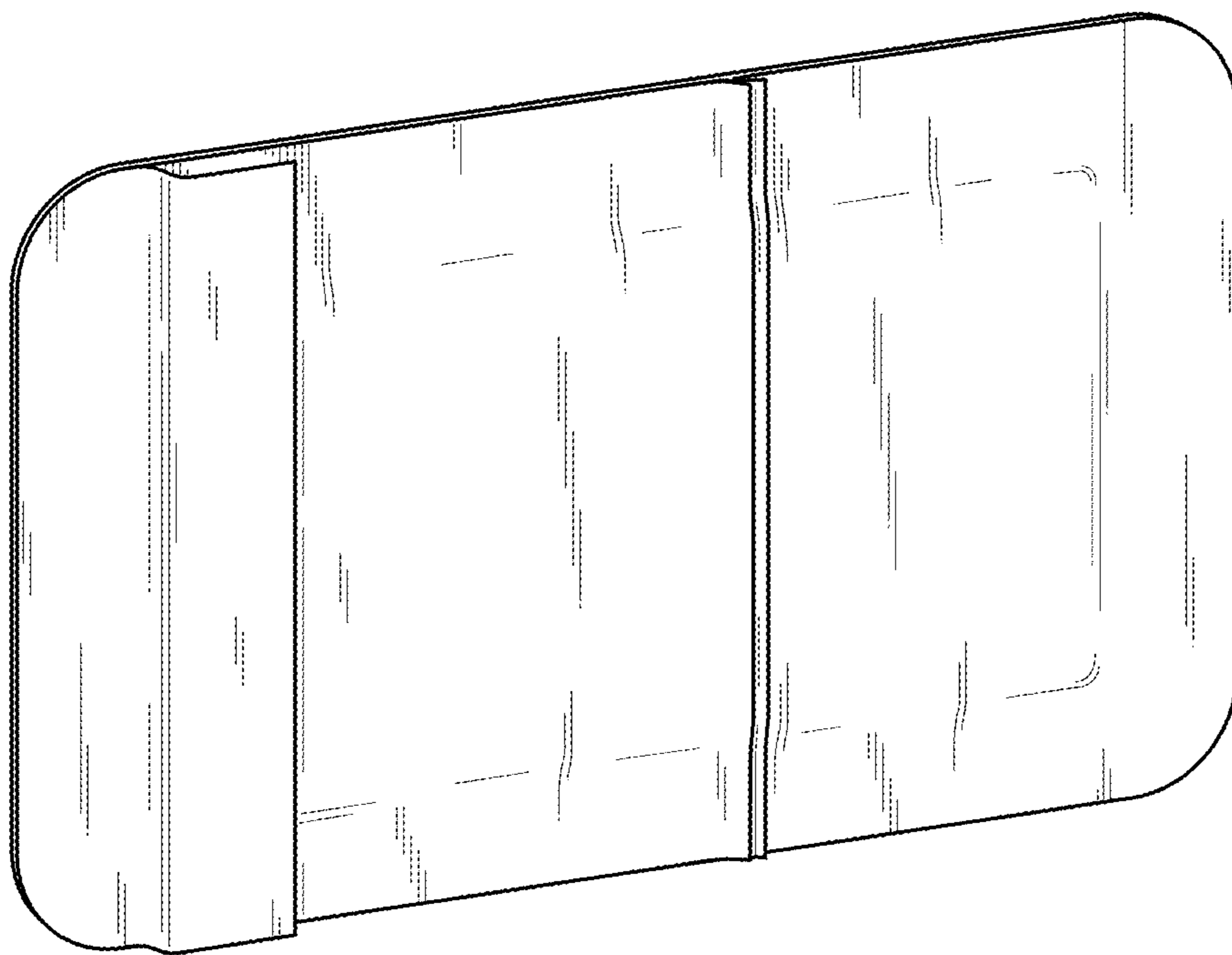

FIG. 1

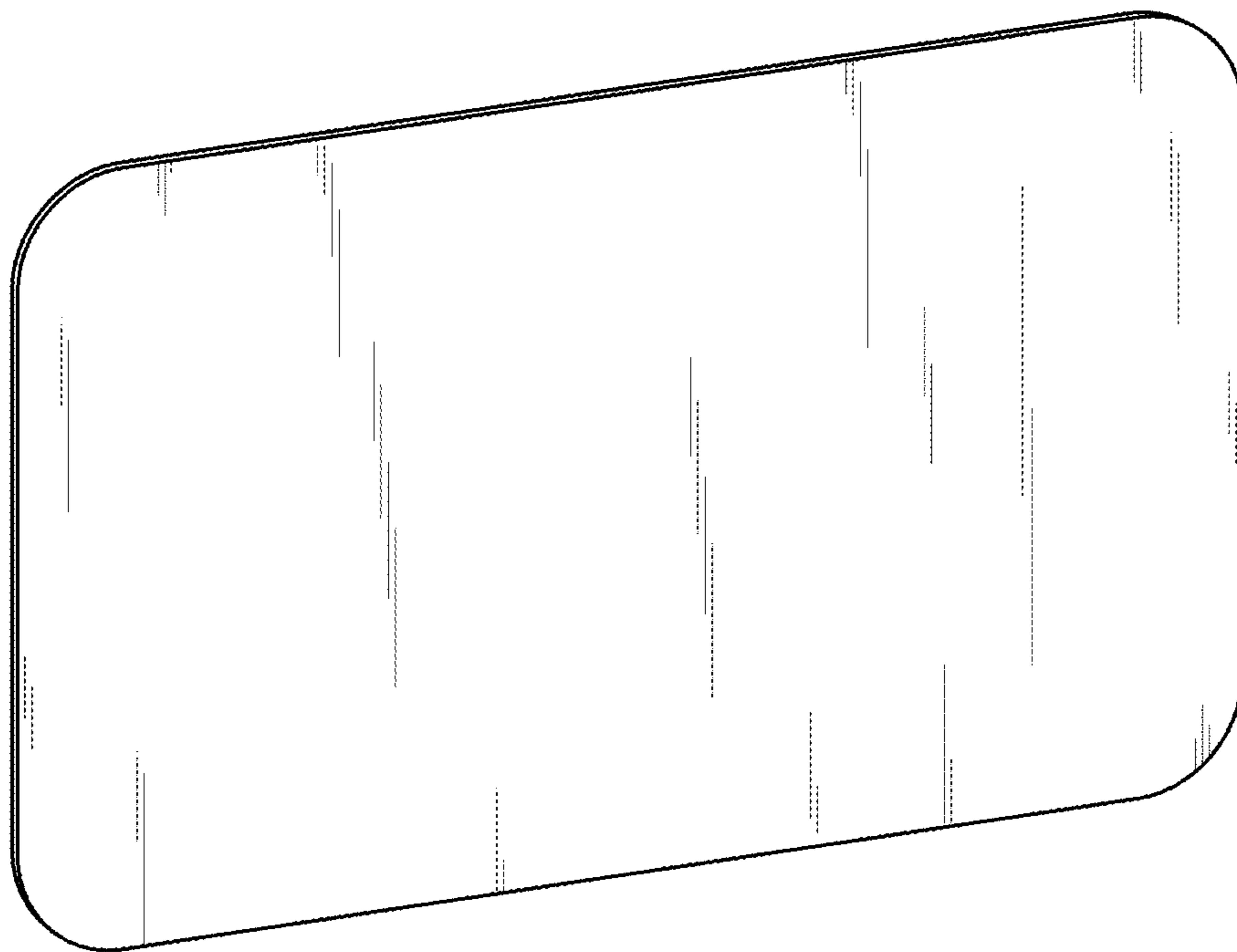

FIG. 2

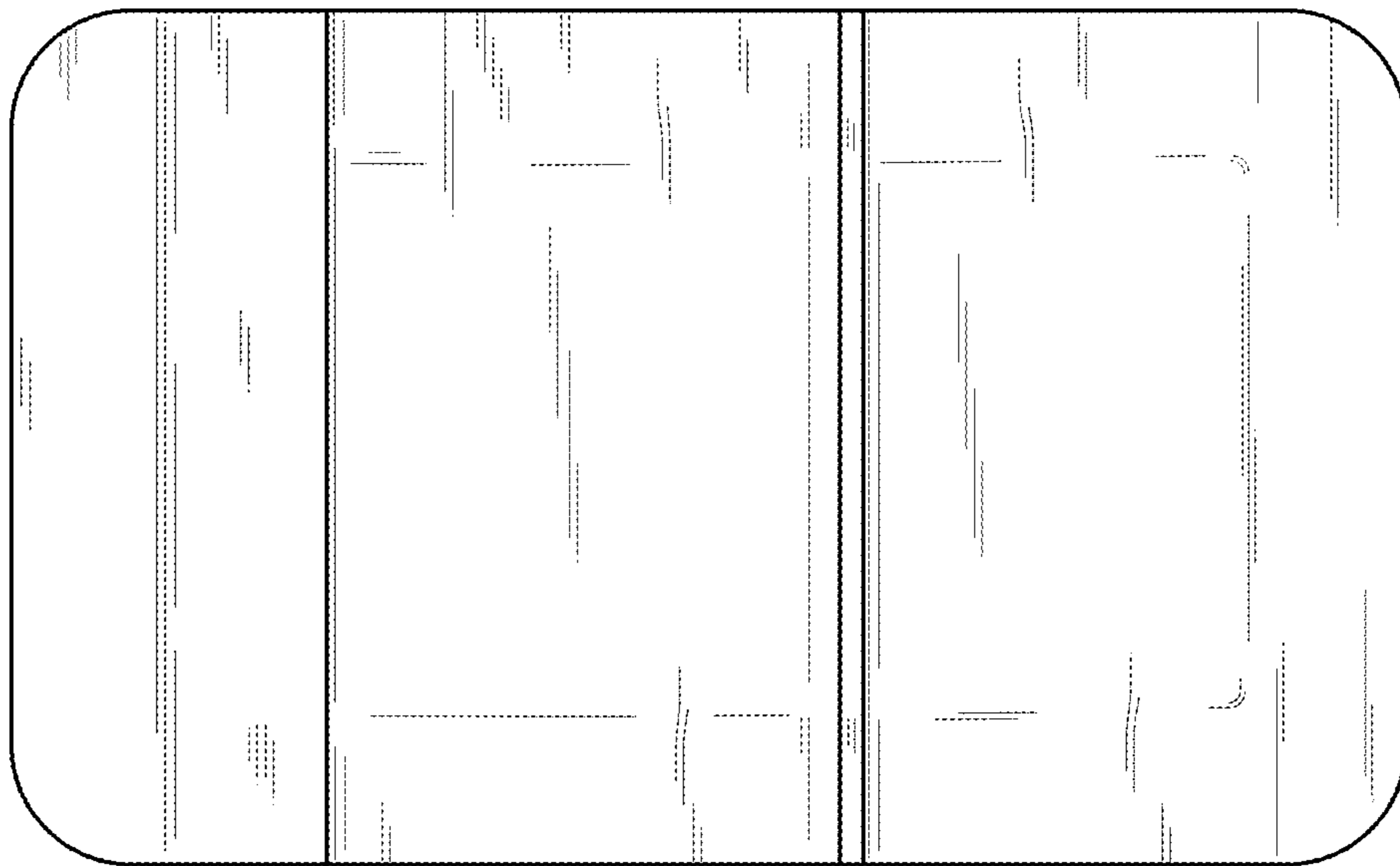

FIG. 3

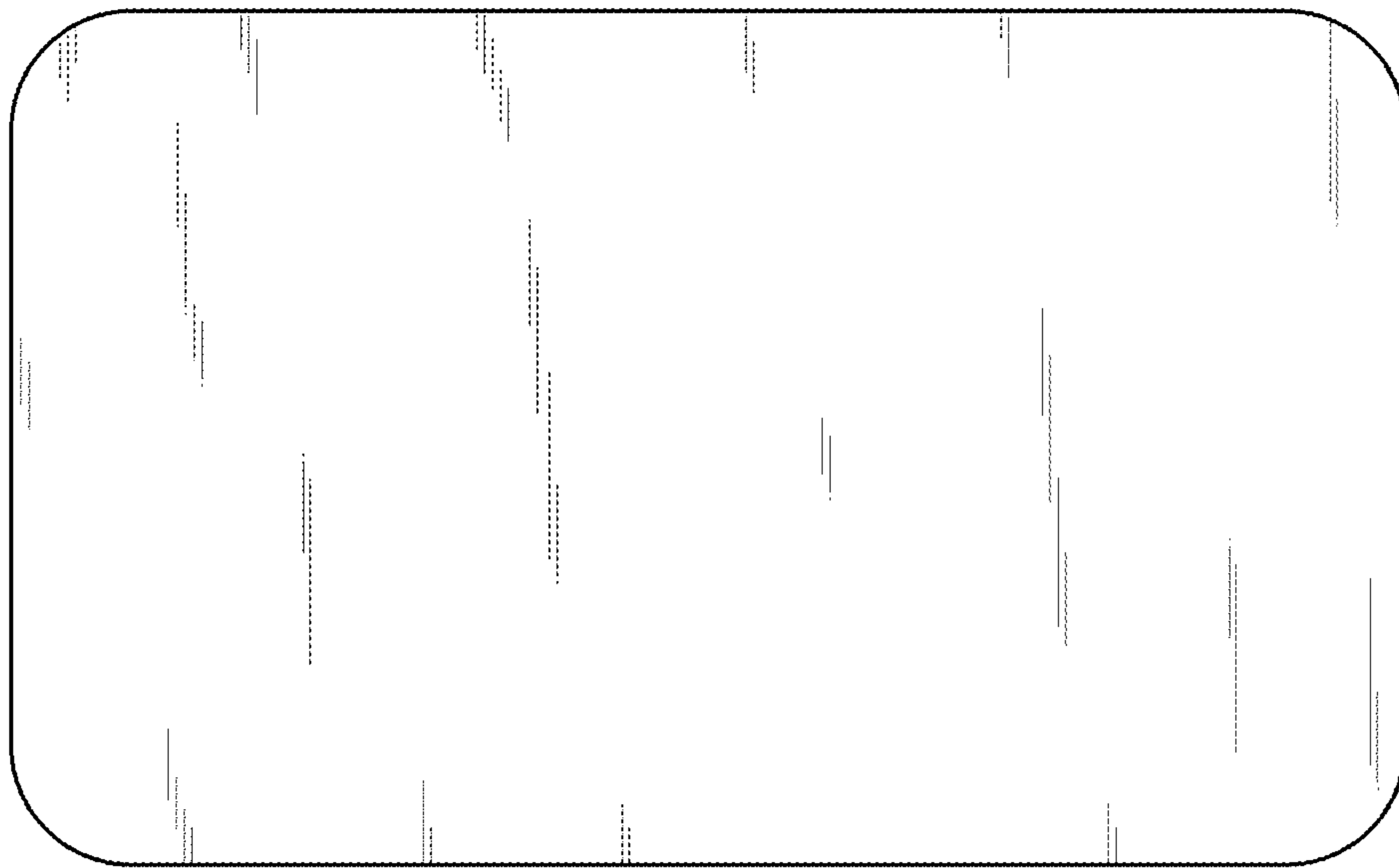

FIG. 4



FIG. 5

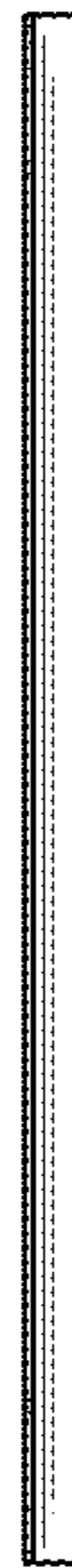

FIG. 6

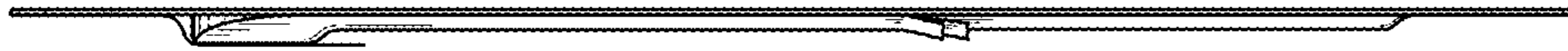

FIG. 7

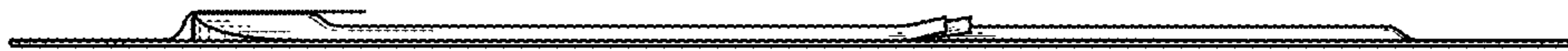

FIG. 8

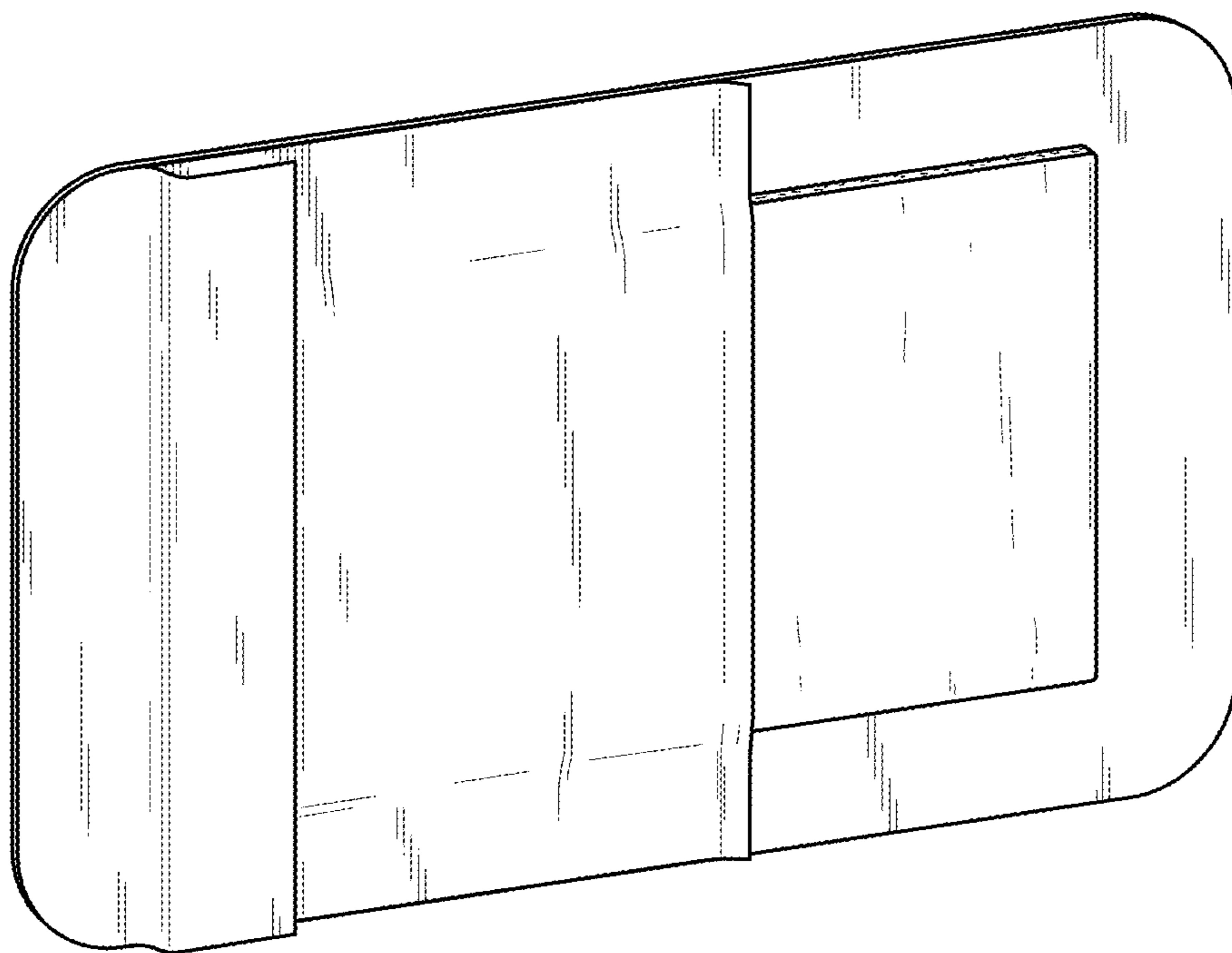

FIG. 9

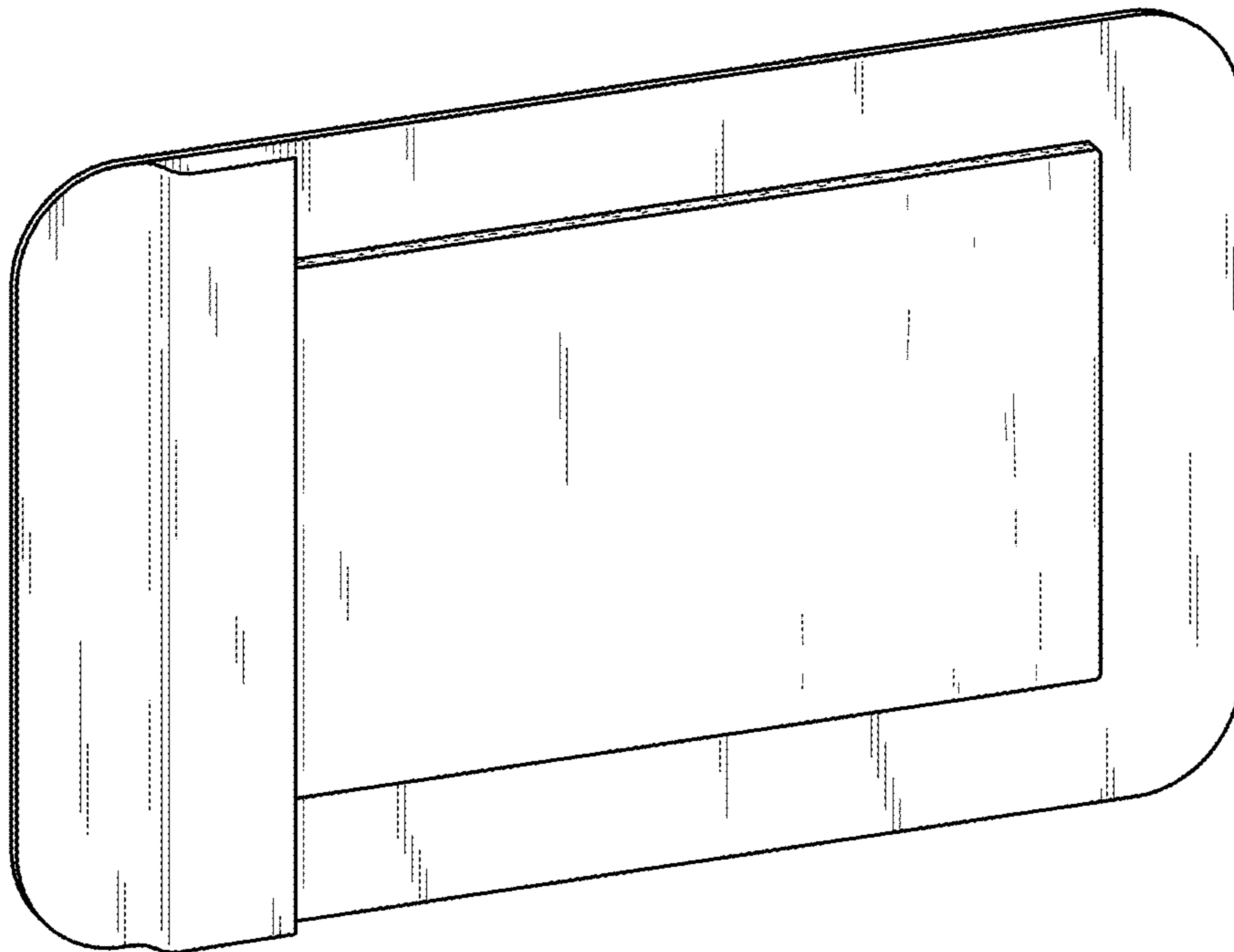

FIG. 10

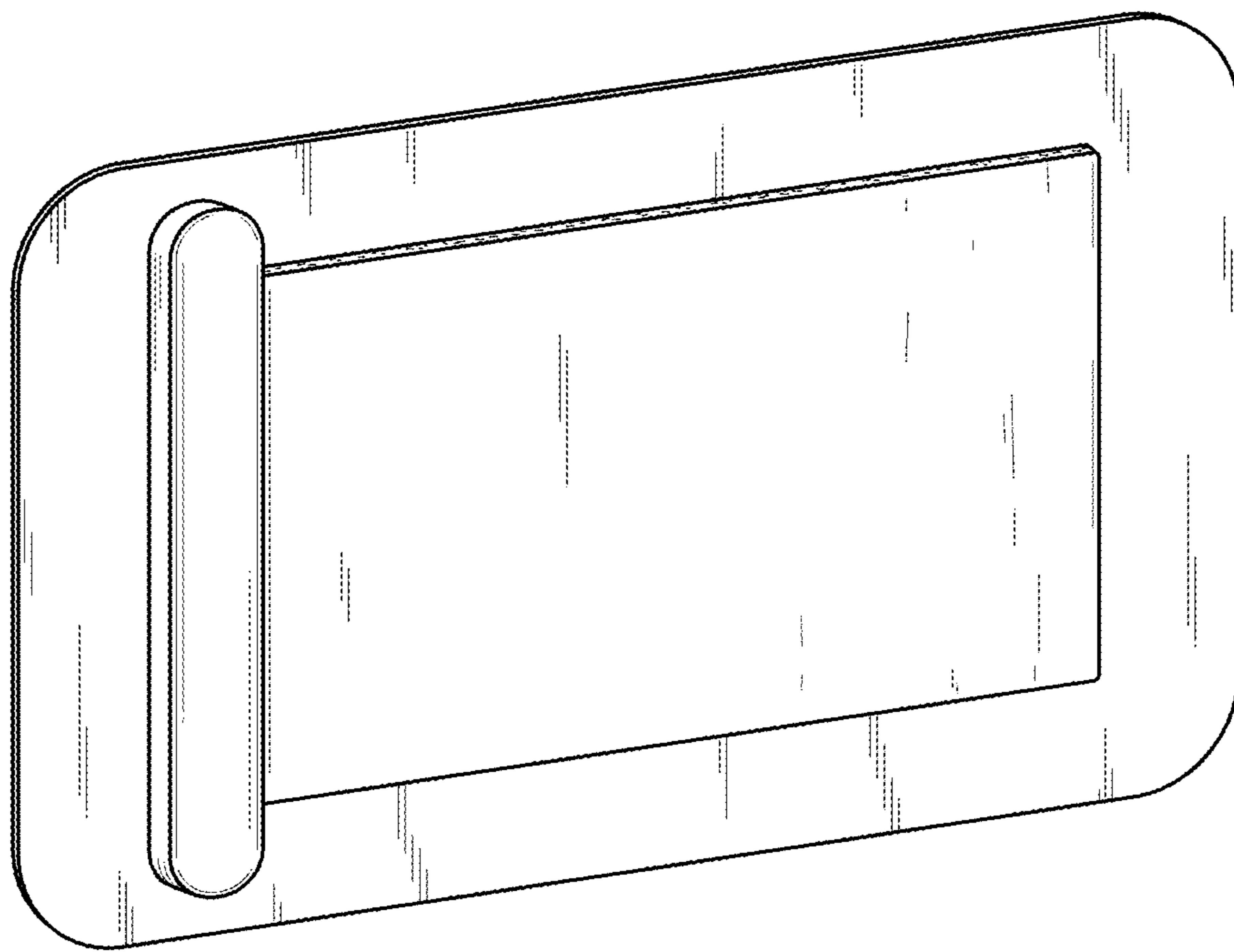

FIG. 11

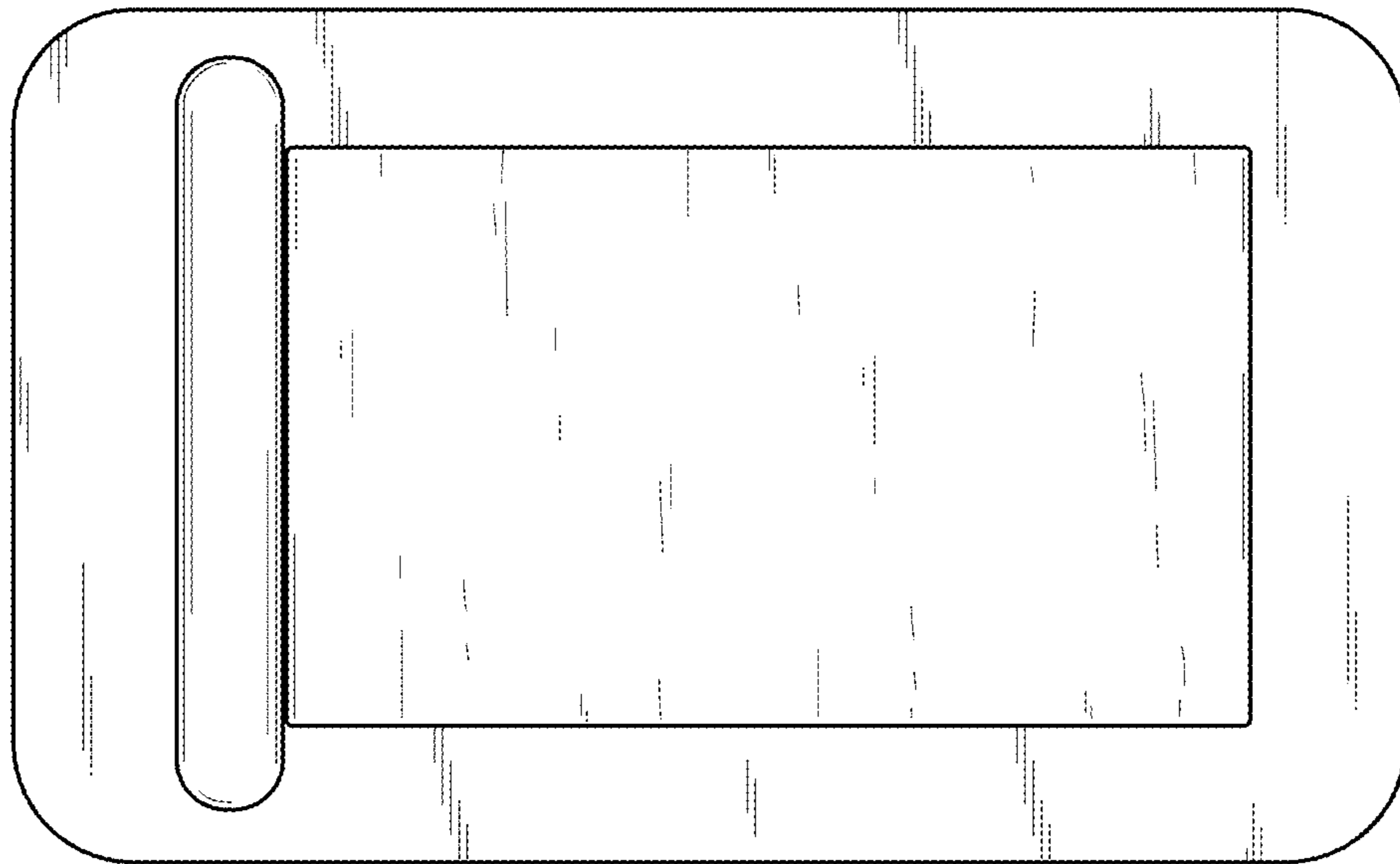

FIG. 12



FIG. 13



FIG. 14

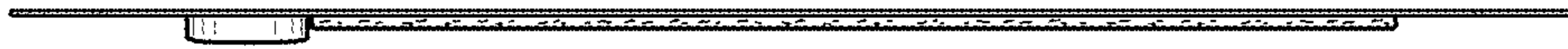

FIG. 15

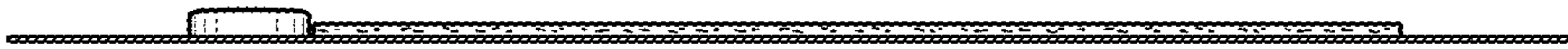

FIG. 16

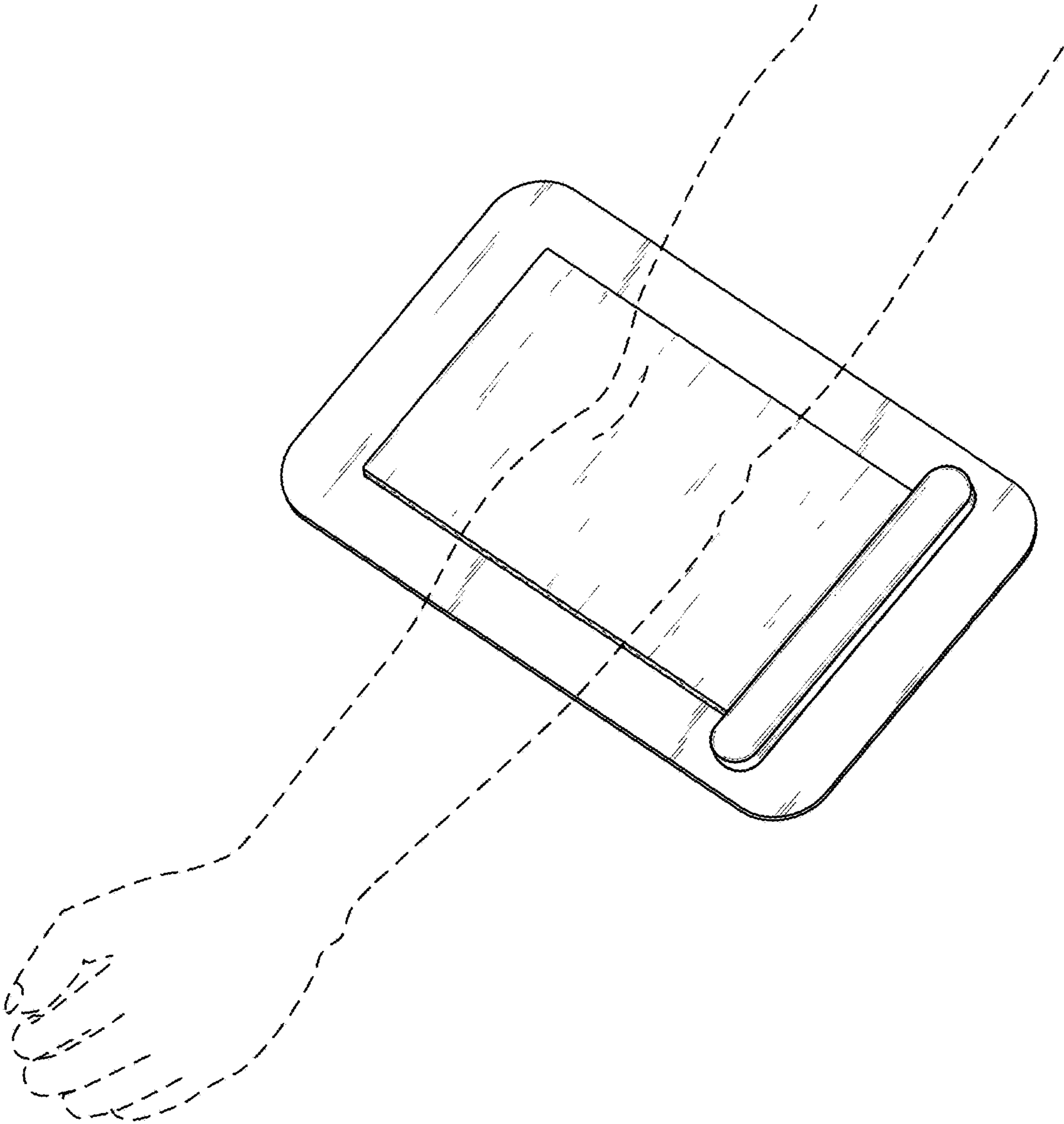

FIG. 17

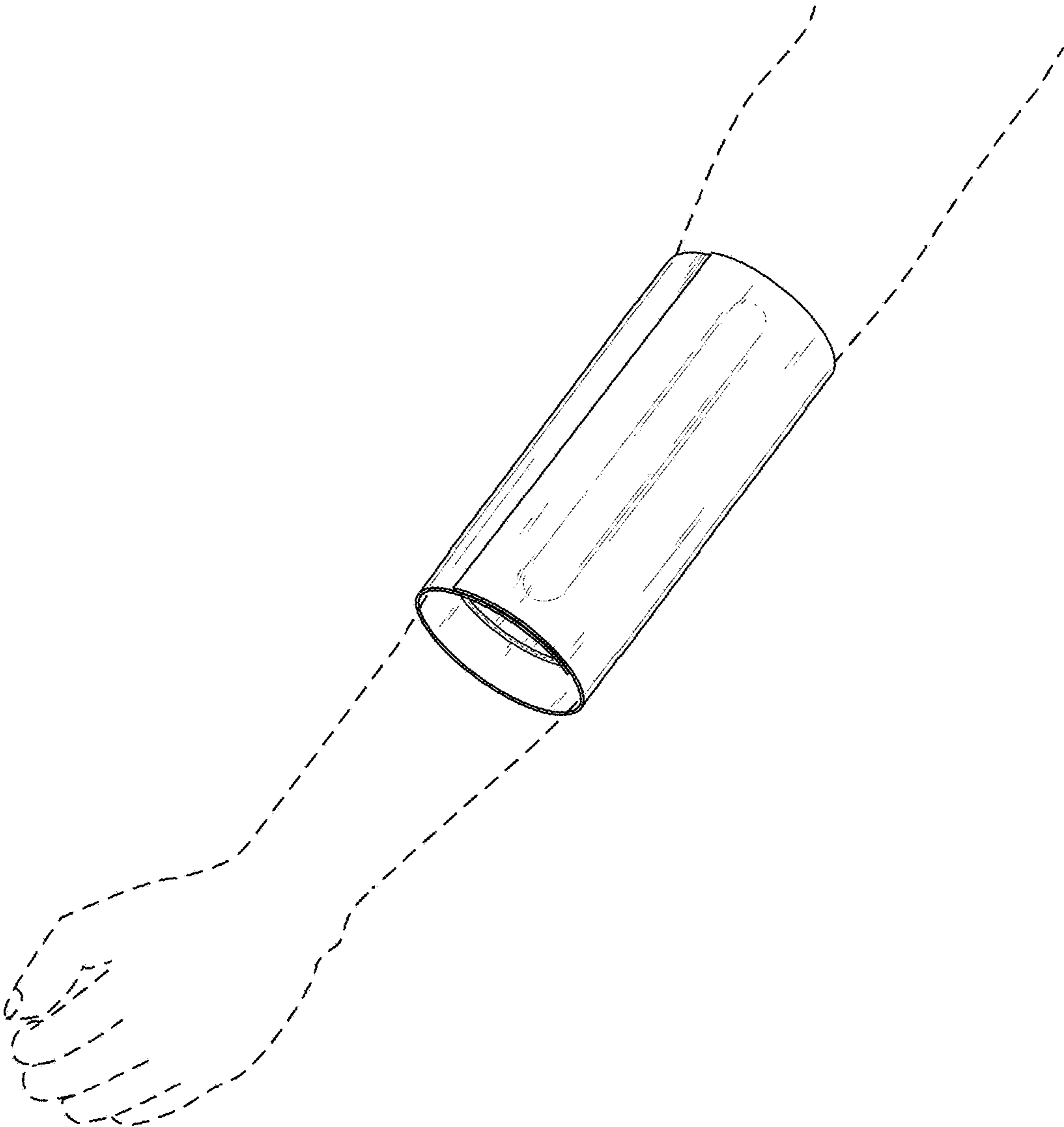

FIG. 18

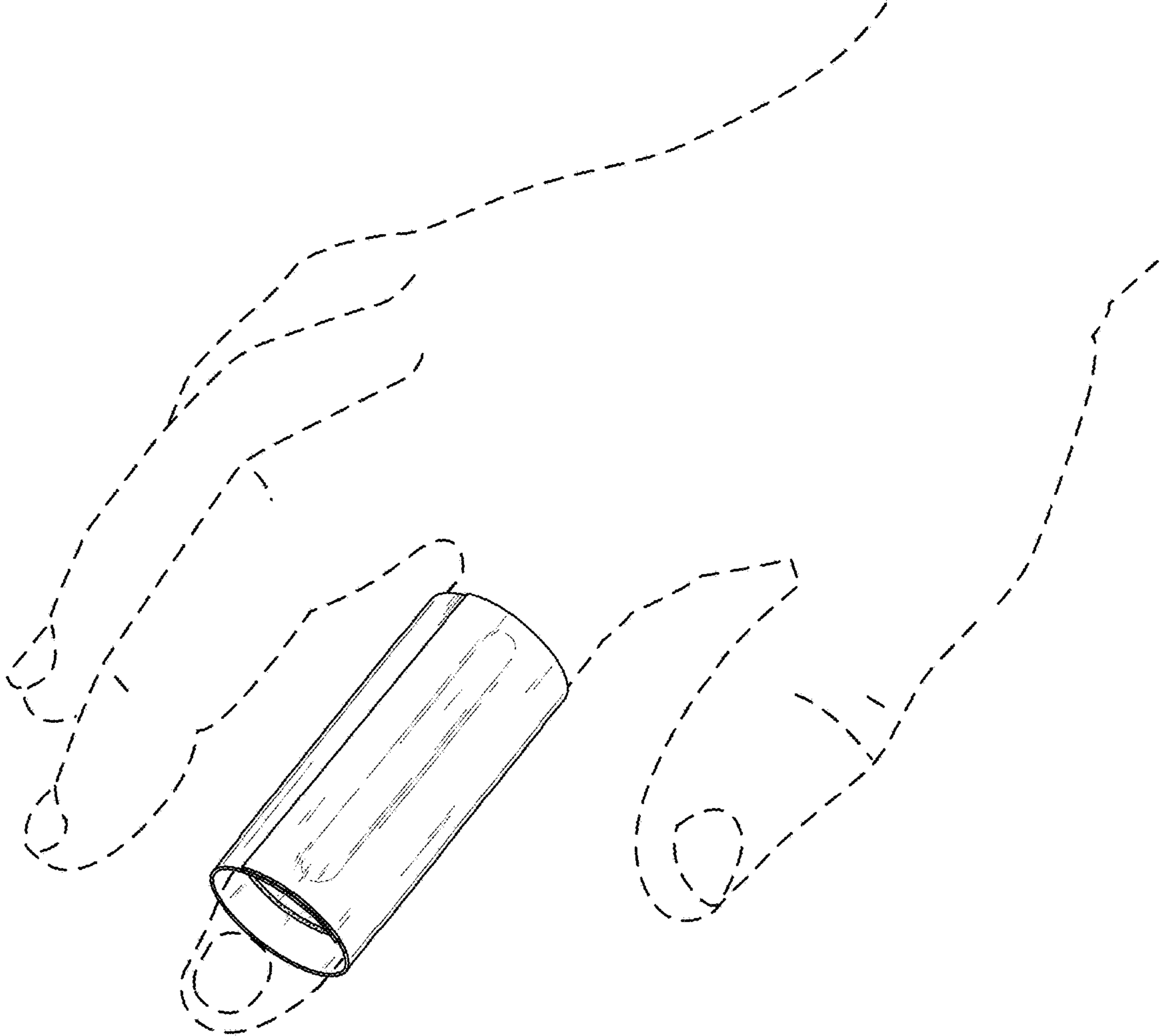

FIG. 19