



US00D843535S

(12) **United States Design Patent**
Kopf

(10) **Patent No.:** **US D843,535 S**

(45) **Date of Patent:** **** Mar. 19, 2019**

- (54) **TRAMPOLINE WITH A SKIRT**
- (71) Applicant: **Bellicon AG**, Lucerne (CH)
- (72) Inventor: **Guenter Kopf**, Lahr (DE)
- (73) Assignee: **Bellicon AG**, Lucerne (CH)
- (**) Term: **15 Years**

- D362,478 S 9/1995 Wilkinson et al.
- D363,325 S 10/1995 Wilkinson
- 5,545,110 A 8/1996 Hsiang
- D384,115 S 9/1997 Wilkinson et al.
- 6,001,045 A 12/1999 Gift et al.
- 6,053,845 A 4/2000 Publicover et al.
- (Continued)

- (21) Appl. No.: **29/612,319**
- (22) Filed: **Jul. 31, 2017**
- (51) **LOC (11) Cl.** **21-02**
- (52) **U.S. Cl.**
USPC **D21/797**
- (58) **Field of Classification Search**
USPC D21/797, 668, 669, 834, 826; D6/716;
482/27, 35, 29, 112, 33, 110, 148, 28, 77,
482/147, 51; 297/452.18; 135/96, 117;
D30/112; D25/1, 16, 22, 56; 446/220;
473/469; 182/139, 224; 273/395, 402
CPC A63B 5/11; A63B 21/023; A63B 2208/12;
A63B 71/022; A63B 2210/50
See application file for complete search history.

OTHER PUBLICATIONS

A Thrifty Mom. "Replace a Worn Out Trampoline Safety Pad with Pool Noodles—Easy DIY". Apr. 18, 2014. <http://athriftymom.com/replace-a-worn-out-trampoline-safety-pad-with-pool-noodles-easy-diy/>.

(Continued)

Primary Examiner — Ryan Harvey

(74) *Attorney, Agent, or Firm* — Husch Blackwell LLP

(57) **CLAIM**

The ornamental design for a trampoline with a skirt, as shown and described.

DESCRIPTION

FIG. 1 is a front perspective view of a trampoline with a skirt showing the new design;
 FIG. 2 is a top plan view thereof;
 FIG. 3 is a bottom plan view thereof;
 FIG. 4 is a front elevation view thereof;
 FIG. 5 is a rear elevation view thereof;
 FIG. 6 is a right elevation view thereof; and,
 FIG. 7 is a left elevation view thereof.

The broken lines in the drawings represent unclaimed environmental subject matter and form no part of the claim. In FIGS. 1-3, the intermittent lines extending along the circular perimeter of the jumping mat represent stitching and are part of the claimed design. In FIG. 3, the circular band bordering the jumping mat is flat and planar.

(56) **References Cited**

U.S. PATENT DOCUMENTS

- 3,195,890 A 7/1965 Sails
- 3,256,021 A 6/1966 Nissen et al.
- 3,765,673 A 10/1973 Daw
- 4,331,329 A * 5/1982 Mirkovich A63B 5/11
482/27
- D270,557 S 9/1983 Williams
- 4,477,070 A 10/1984 Appelbaum
- 4,489,933 A 12/1984 Fisher et al.
- 4,598,905 A 7/1986 Vrana
- D287,909 S * 1/1987 Weiss D21/797
- 4,730,826 A 3/1988 Sudmeier
- 4,824,100 A * 4/1989 Hall A63B 5/11
482/28
- D304,850 S 11/1989 Chambers
- D325,951 S 5/1992 Johnson

1 Claim, 7 Drawing Sheets

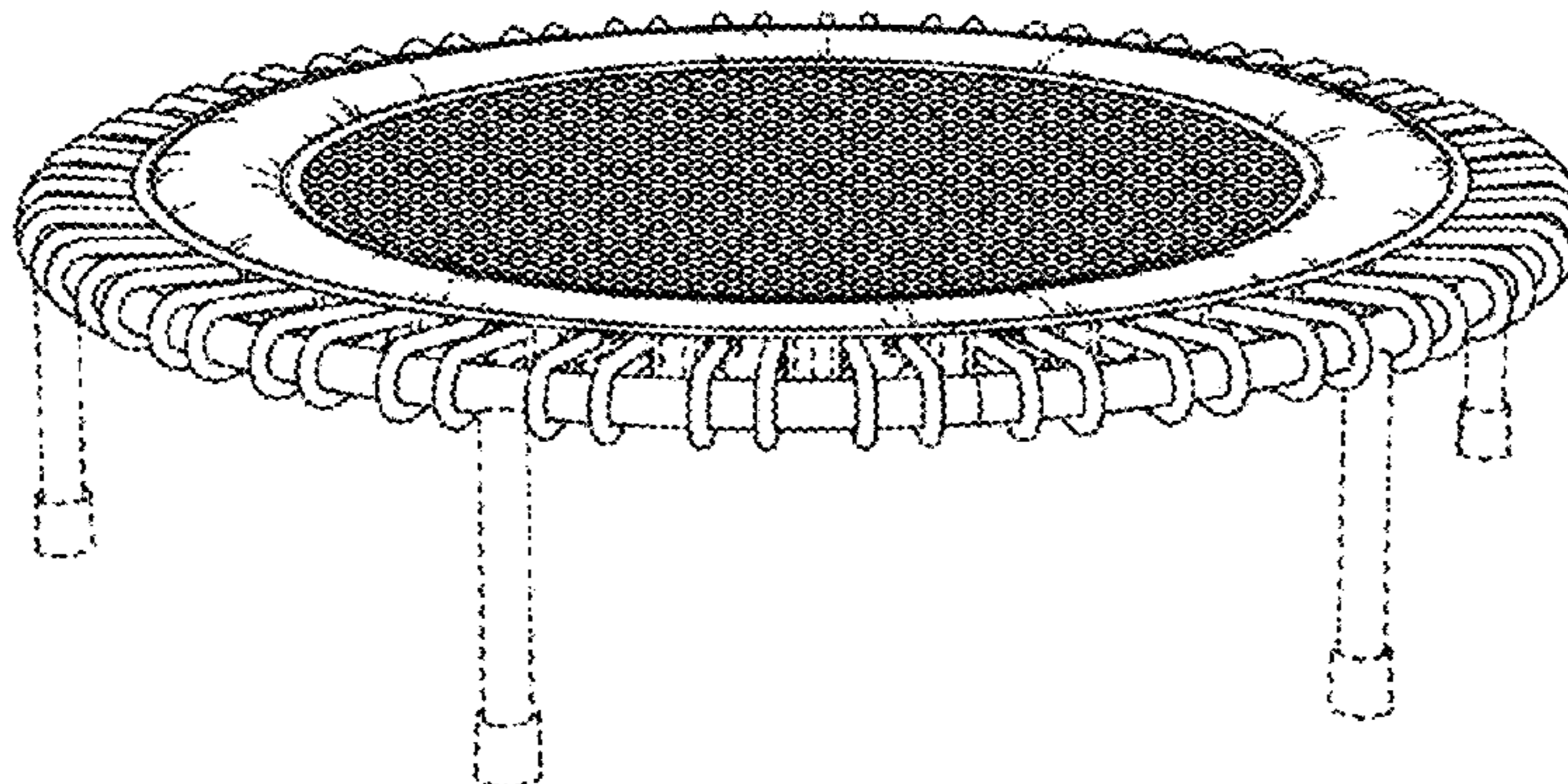

(56)

References Cited

U.S. PATENT DOCUMENTS

6,139,474 A 10/2000 Gift et al.
 6,162,061 A * 12/2000 Taylor A63B 5/11
 434/253
 6,193,632 B1 2/2001 Steger
 D496,422 S 9/2004 Rota
 6,840,891 B2 1/2005 Publicover
 D504,711 S 5/2005 Hsiung
 D570,947 S 6/2008 Horne
 8,038,580 B2 10/2011 Schmauck et al.
 D661,360 S * 6/2012 Campanaro D21/797
 D666,266 S 8/2012 Publicover et al.
 8,246,521 B2 8/2012 Alexander et al.
 8,255,807 B2 8/2012 Ganz et al.
 D680,609 S 4/2013 Publicover et al.
 D712,185 S * 9/2014 Akkad D6/716
 D712,497 S 9/2014 Yang et al.
 D716,574 S 11/2014 Akkad
 D720,550 S 1/2015 Akkad
 9,033,853 B1 5/2015 McMurtrey
 D742,467 S * 11/2015 Giorgi D21/797
 D758,515 S * 6/2016 Tsai D21/797
 D777,279 S 1/2017 de Boer
 D777,280 S 1/2017 de Boer
 D777,865 S 1/2017 de Boer
 D786,997 S * 5/2017 Gaut D21/797
 D788,240 S * 5/2017 Ho D21/797
 D788,241 S * 5/2017 Ho D21/797
 D788,243 S 5/2017 Bisang et al.
 9,656,110 B2 * 5/2017 Alexander A63B 5/11
 D788,868 S 6/2017 Bisang et al.
 D791,260 S * 7/2017 Ho D21/797
 D792,934 S * 7/2017 Gaut D21/797
 9,707,426 B2 * 7/2017 Tsai A63B 5/11
 D799,625 S * 10/2017 Chen D21/797
 2002/0137598 A1 9/2002 Publicover et al.
 2002/0160884 A1 10/2002 Hall
 2005/0113213 A1 5/2005 Alexander

2005/0227812 A1 10/2005 James
 2006/0058157 A1 3/2006 Greiner et al.
 2006/0106682 A1 5/2006 Van Dyck et al.
 2006/0172861 A1 8/2006 Wang et al.
 2006/0223676 A1 10/2006 Rote
 2007/0004559 A1 1/2007 Alexander
 2008/0314427 A1 12/2008 Lai
 2009/0280961 A1 11/2009 Ikegami
 2010/0081549 A1 4/2010 Thompson
 2011/0021322 A1 1/2011 Schaffer et al.
 2012/0123897 A1 5/2012 Gargiulo
 2013/0097050 A1 4/2013 Soracco et al.
 2013/0210590 A1 8/2013 Publicover et al.
 2013/0316876 A1 11/2013 Publicover et al.
 2014/0006204 A1 1/2014 Candrian et al.
 2014/0032356 A1 1/2014 Chuang et al.
 2014/0228176 A1 8/2014 Miller et al.
 2014/0287879 A1 9/2014 Hall
 2014/0315691 A1 10/2014 Turner
 2014/0336005 A1 11/2014 Miller
 2014/0342880 A1 11/2014 Nelson et al.
 2014/0344098 A1 11/2014 Vaughn
 2015/0006313 A1 1/2015 Beaver et al.
 2015/0076888 A1 3/2015 Xu et al.
 2015/0080186 A1 3/2015 Carlin et al.
 2015/0157889 A1 6/2015 Miller
 2016/0310774 A1 * 10/2016 Publicover A63B 5/11
 2017/0182343 A1 * 6/2017 Ho A63B 5/11
 2017/0232288 A1 * 8/2017 Ho A63B 5/11
 482/28

OTHER PUBLICATIONS

Alibaba.com, Fitness Bungee Trampoline Hexagon Trampoline Rebounder, http://www.alibaba.com/product-detail/Fitness-bungree-trampoline-hexagone-trampoline-rebounder_60030786115.html; printed Sep. 26, 2014.

* cited by examiner

FIG. 1

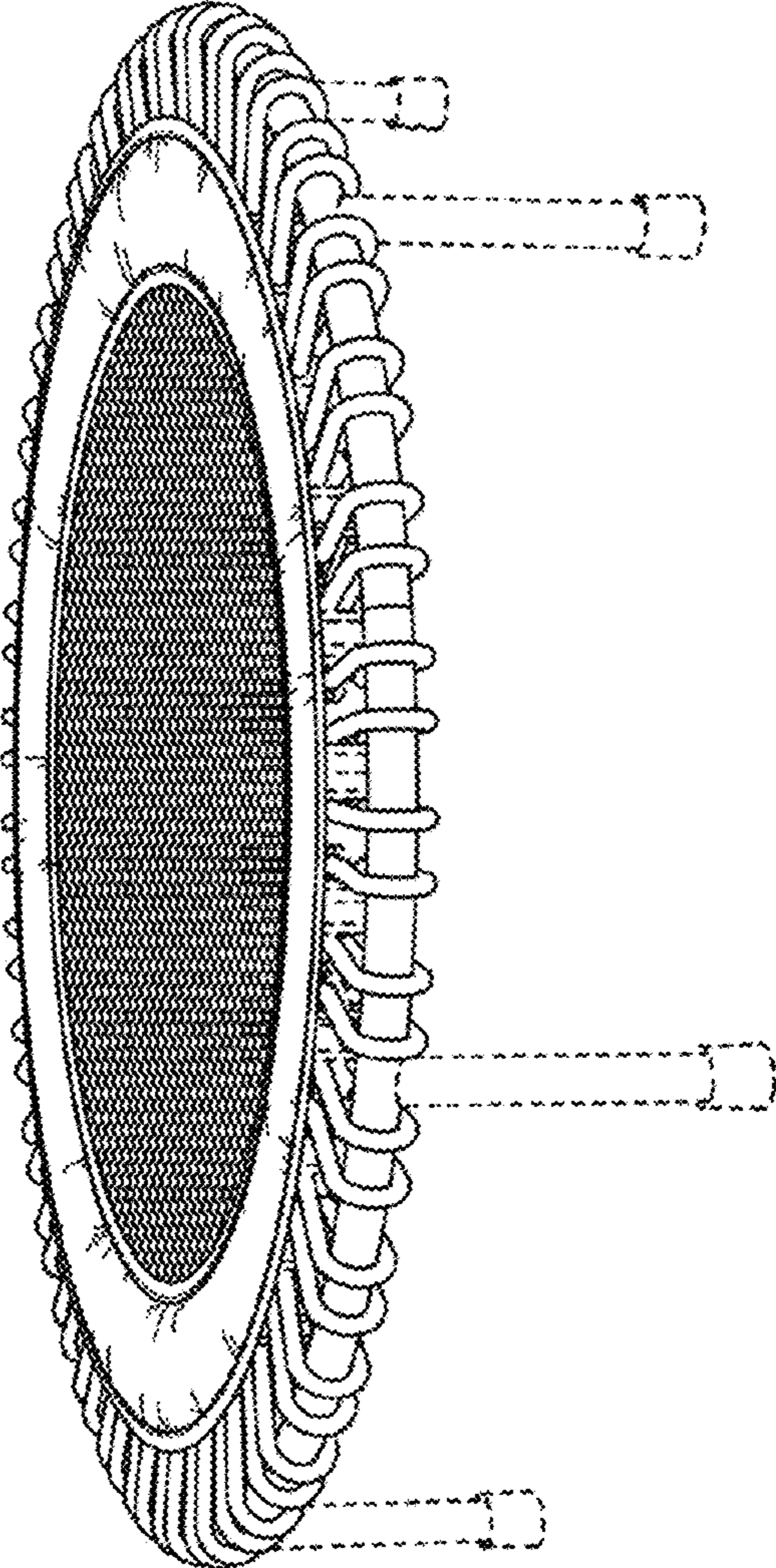

FIG. 2

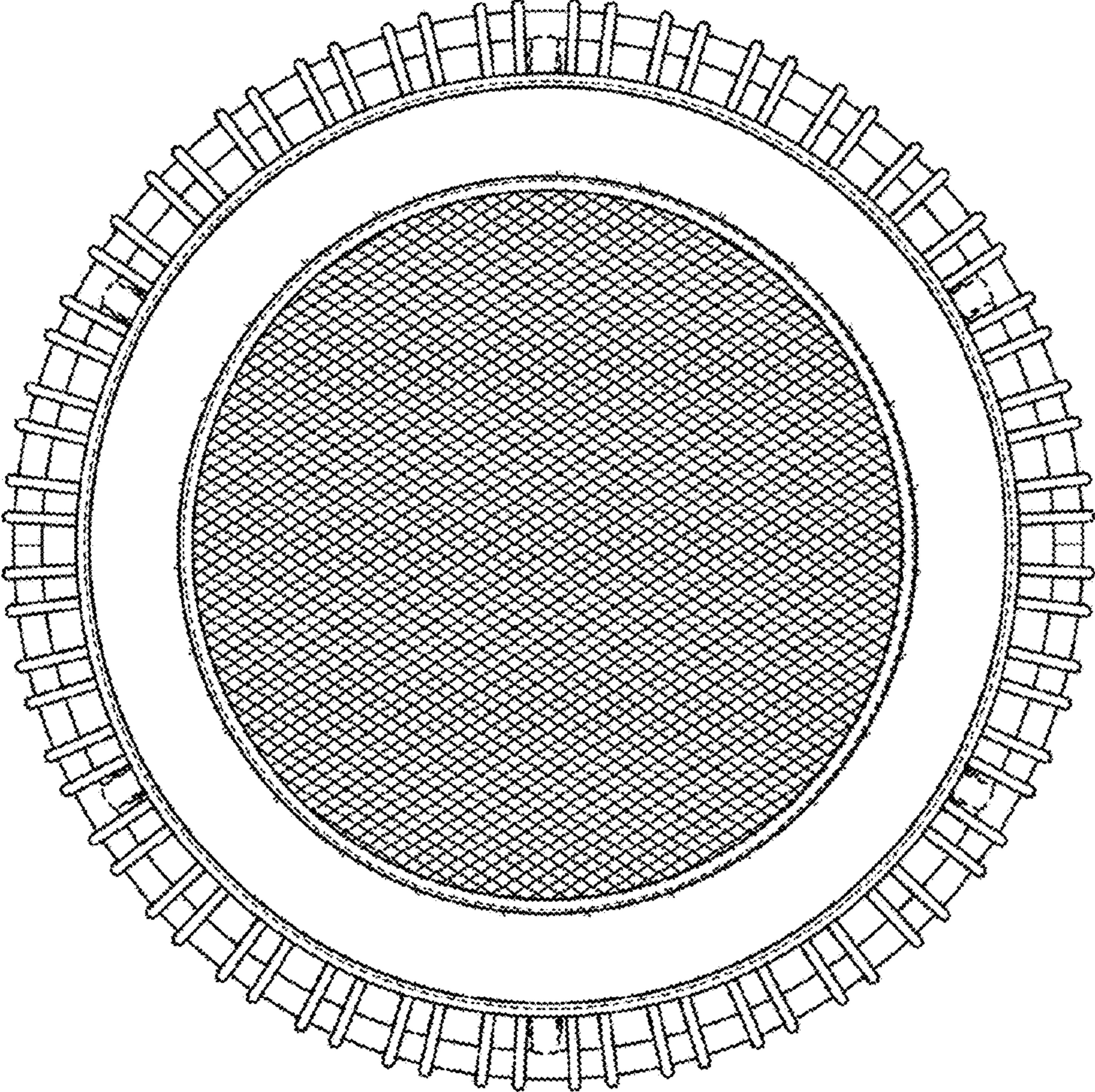

FIG. 3

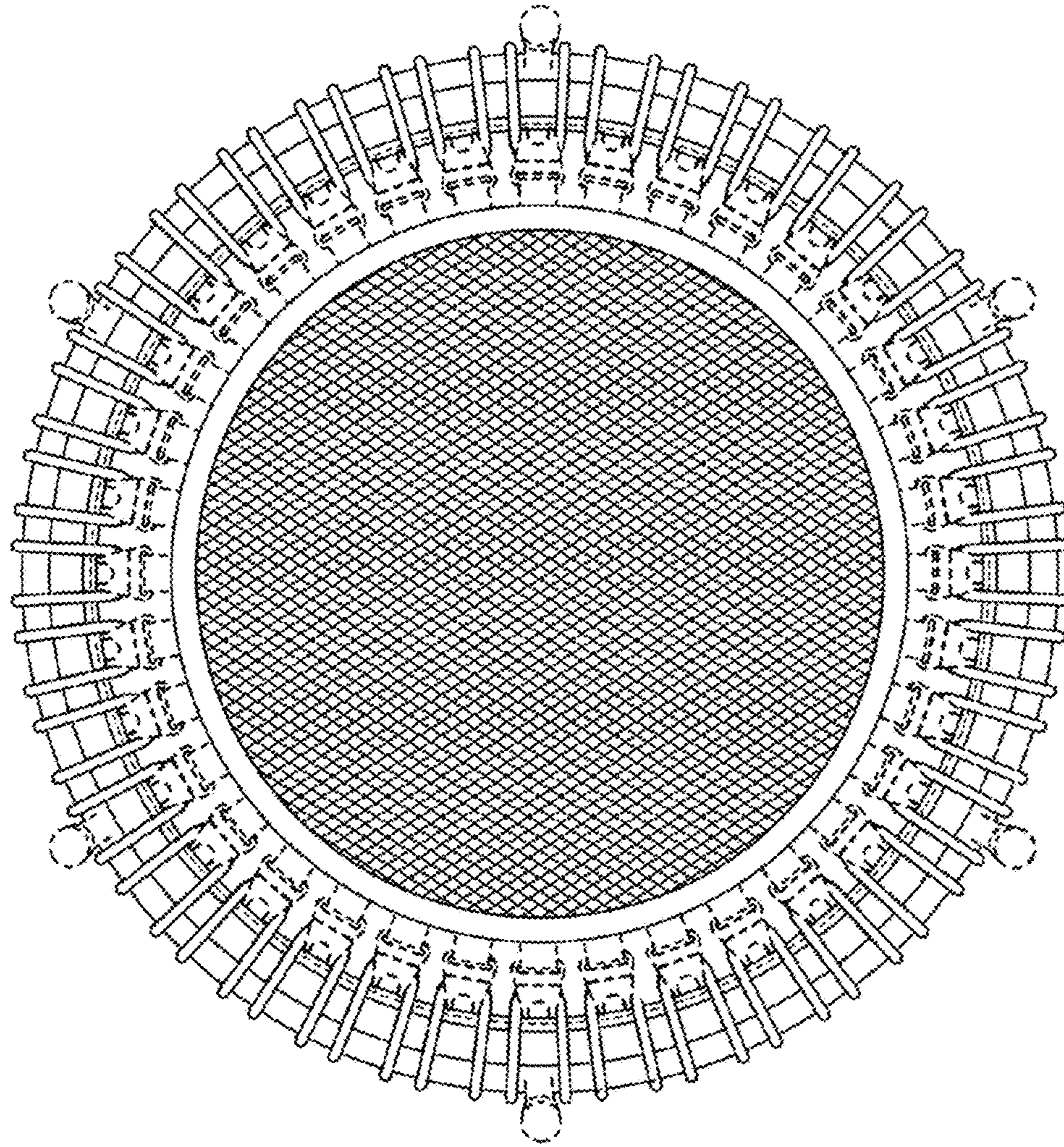

FIG. 4

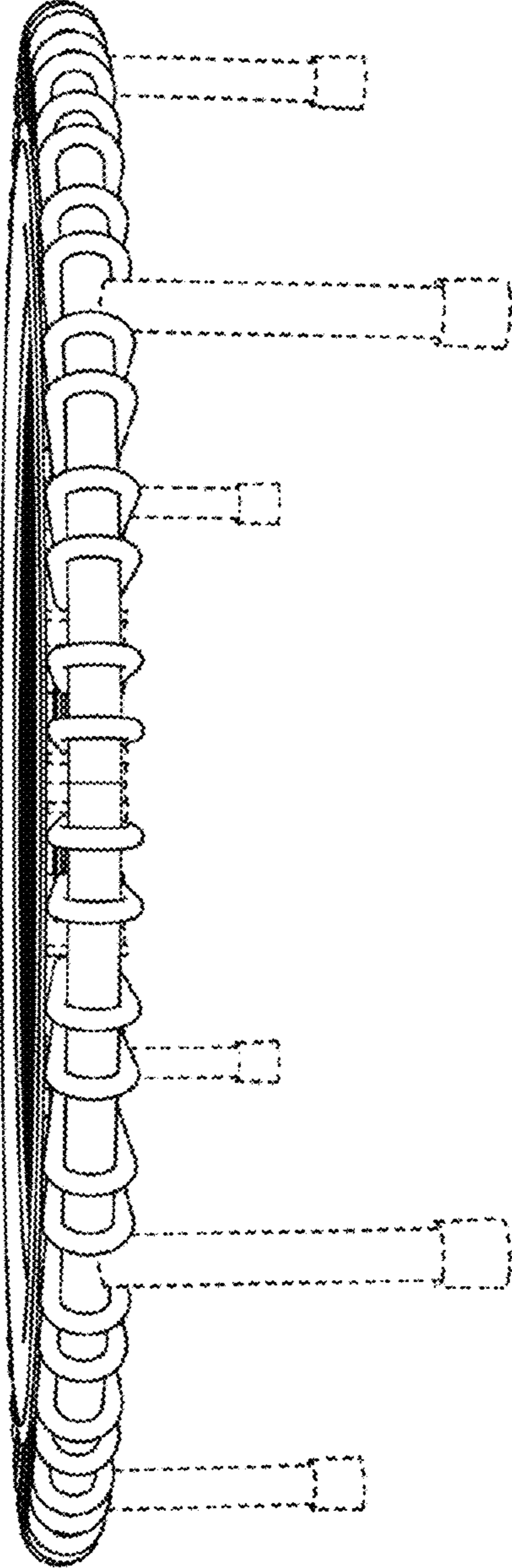

FIG. 5

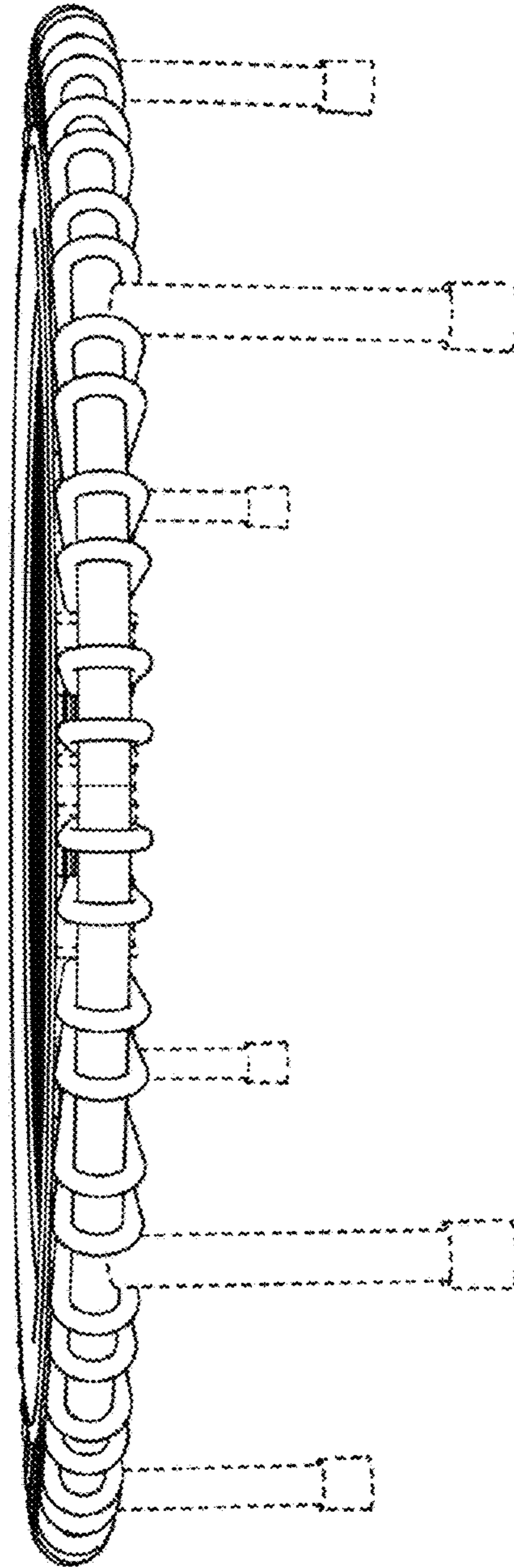

FIG. 6

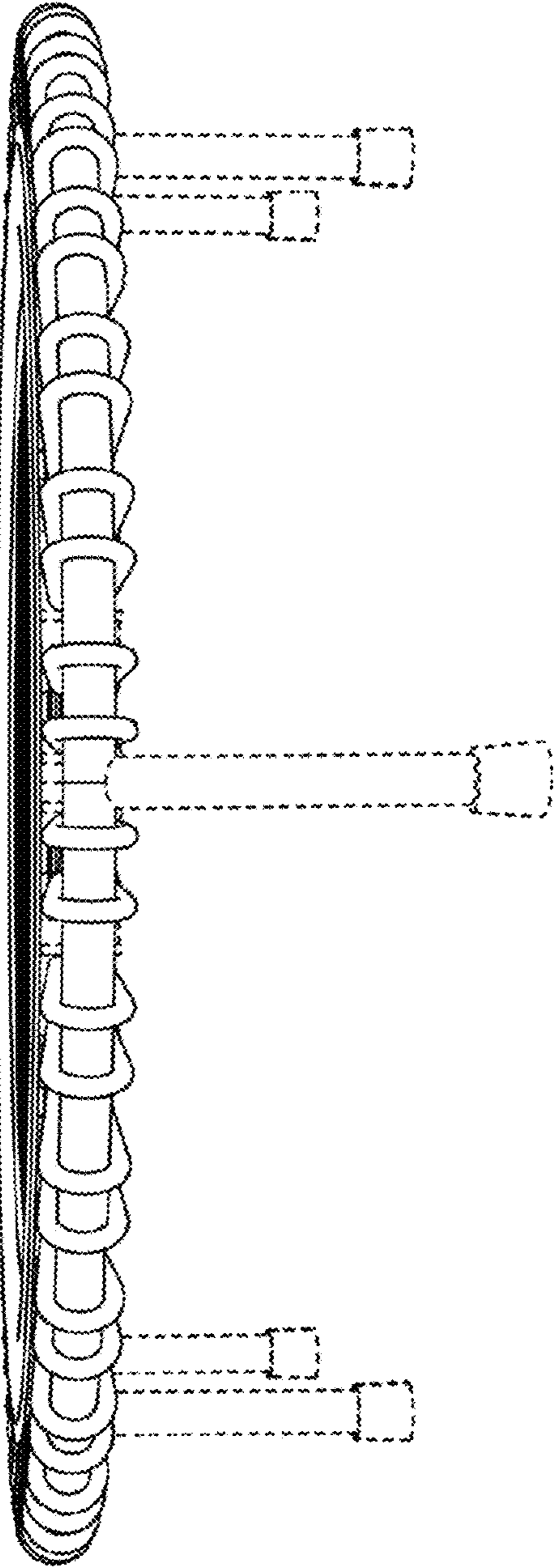

FIG. 7

