



US00D843430S

(12) **United States Design Patent**  
**Hodgson**

(10) **Patent No.:** **US D843,430 S**

(45) **Date of Patent:** **\*\* Mar. 19, 2019**

(54) **MAGNIFIER**

(71) Applicant: **The Daylight Company (Holdings) Limited, London (GB)**

(72) Inventor: **Fraser Hodgson, London (GB)**

(73) Assignee: **The Daylight Company (Holdings) Limited (GB)**

(\*\*) Term: **15 Years**

(21) Appl. No.: **29/570,368**

(22) Filed: **Jul. 7, 2016**

(30) **Foreign Application Priority Data**

Feb. 25, 2016 (EM) ..... 003002252-0002

(51) **LOC (11) Cl.** ..... **16-06**

(52) **U.S. Cl.**  
USPC ..... **D16/135**

(58) **Field of Classification Search**  
USPC ..... D16/130, 134, 135; D14/203.3-203.7,  
D14/217, 238.1, 240, 248, 250-253  
CPC ..... G02B 27/026; H04J 11/00; H04J 13/00  
See application file for complete search history.

(56) **References Cited**

**U.S. PATENT DOCUMENTS**

D278,087 S \* 3/1985 Pruefer ..... D16/101  
6,816,325 B1 \* 11/2004 Becker ..... G02B 7/023  
359/811

D526,340 S \* 8/2006 Hodgson ..... D16/135  
D586,833 S \* 2/2009 Huang ..... D16/135  
D602,967 S \* 10/2009 Hui ..... D16/135  
D636,513 S \* 4/2011 Furtsch ..... D16/135  
D688,289 S \* 8/2013 Hodgson ..... D16/135  
D690,457 S \* 9/2013 Lu ..... D26/118  
D704,239 S \* 5/2014 Faul ..... G02B 5/3083  
D16/130  
D707,279 S \* 6/2014 Tang ..... G02B 25/02  
D16/135  
D750,679 S \* 3/2016 Habraken ..... D16/135  
D807,937 S \* 1/2018 Warr ..... D16/135

\* cited by examiner

*Primary Examiner* — Mark A Goodwin

*Assistant Examiner* — Benjamin M Weeks

(74) *Attorney, Agent, or Firm* — Laubscher & Laubscher, P.C.

(57) **CLAIM**

The ornamental design for a magnifier, as shown.

**DESCRIPTION**

FIG. 1 is a top perspective view thereof;  
FIG. 2 is a front elevation view thereof;  
FIG. 3 is a rear elevation view thereof;  
FIG. 4 is a left side elevation view thereof  
FIG. 5 is a right side elevation view thereof;  
FIG. 6 is a top elevation view thereof; and,  
FIG. 7 is a bottom elevation view thereof.

**1 Claim, 5 Drawing Sheets**

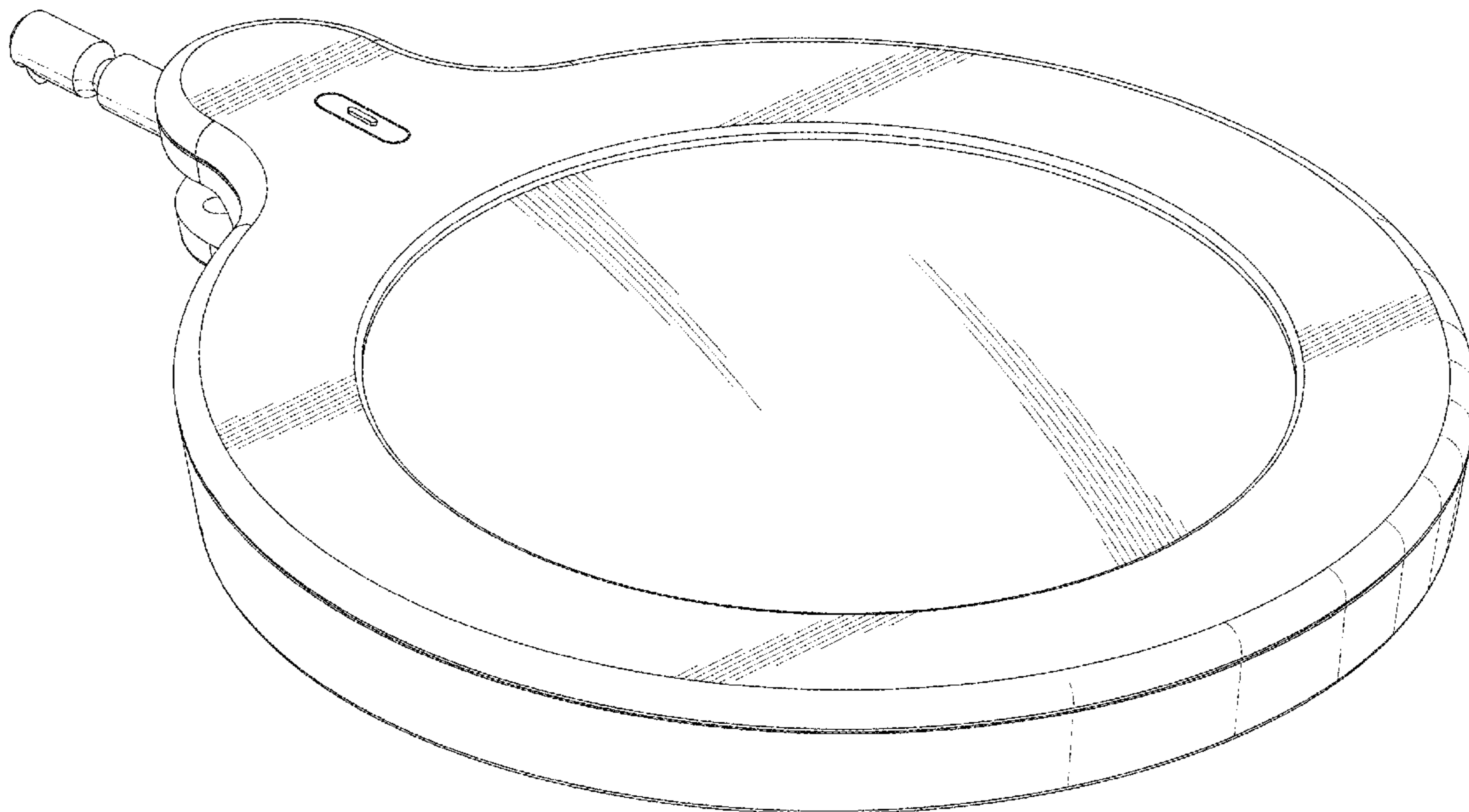

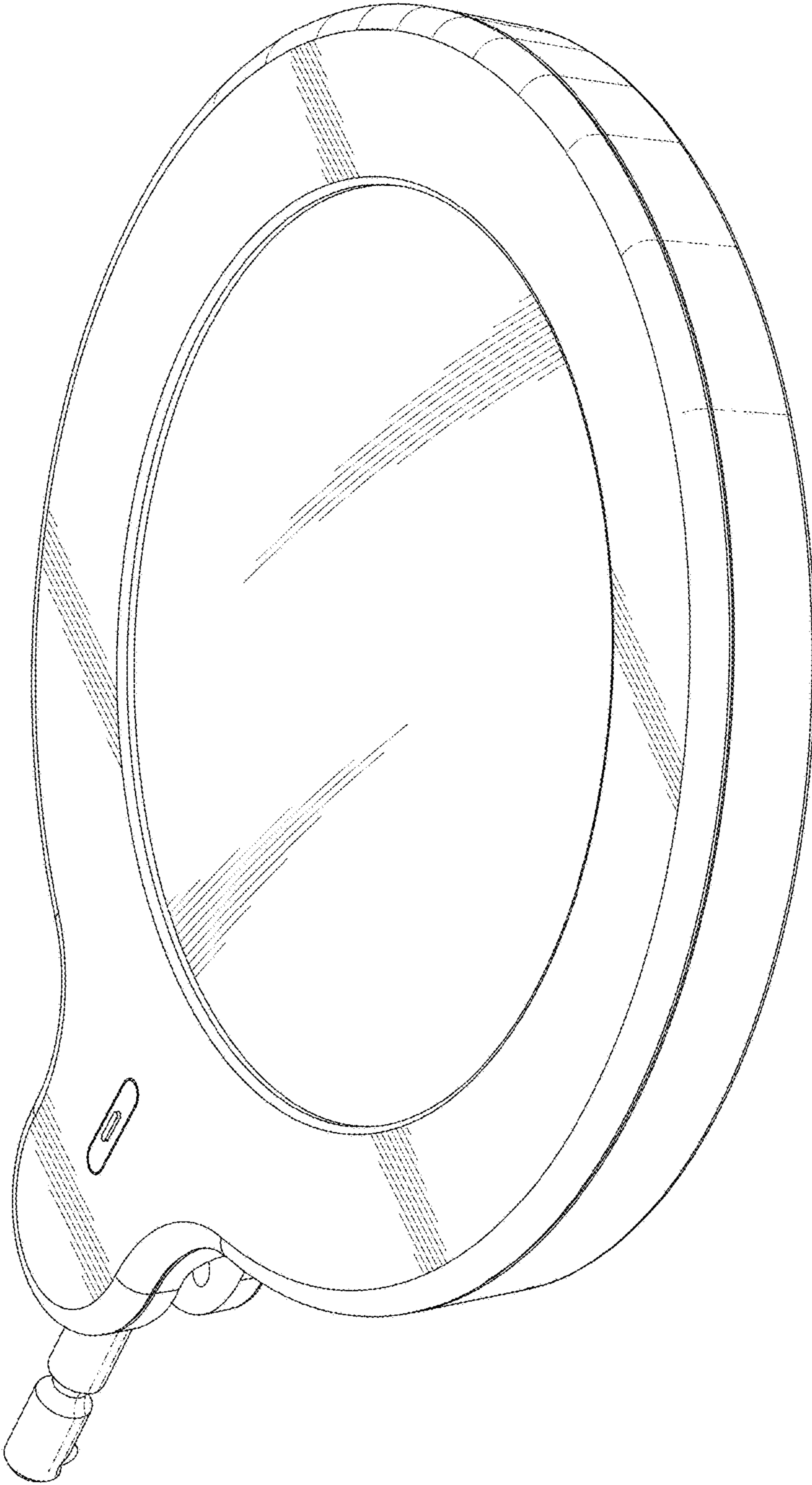

FIG. 1

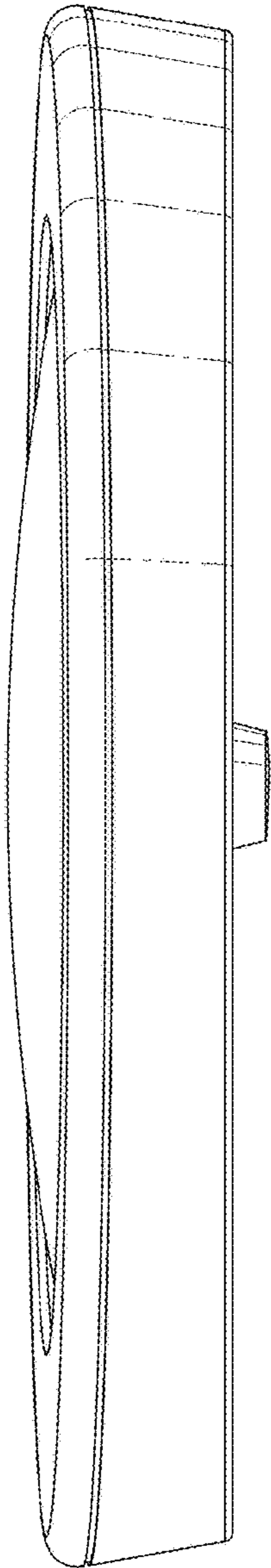

FIG. 2

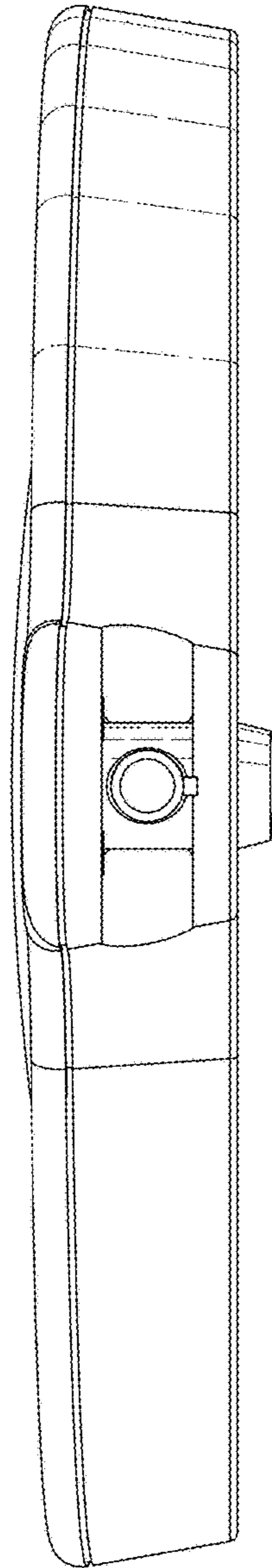

FIG. 3

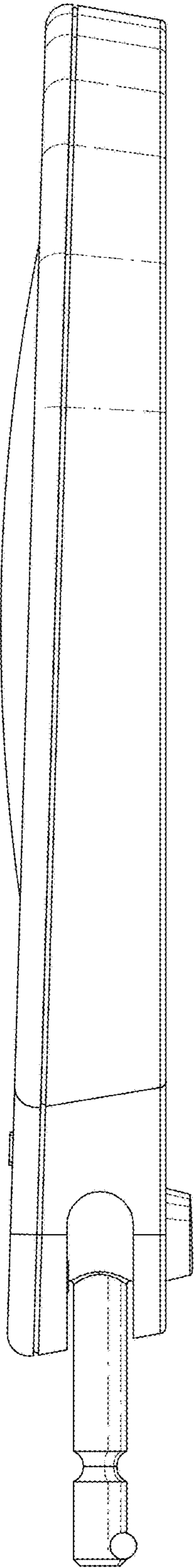

FIG. 4

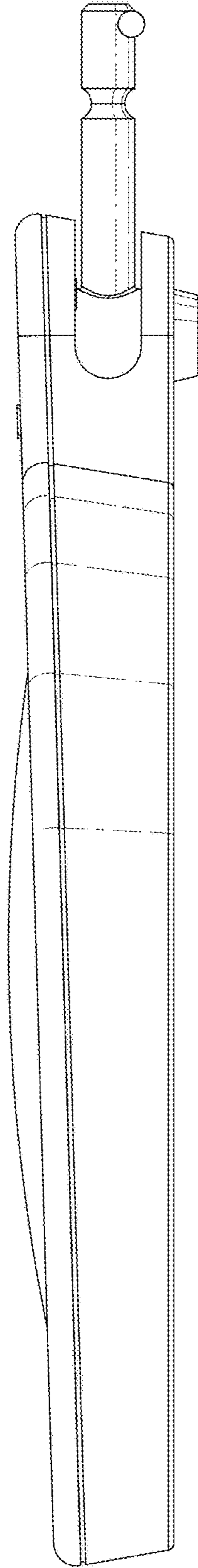

FIG. 5



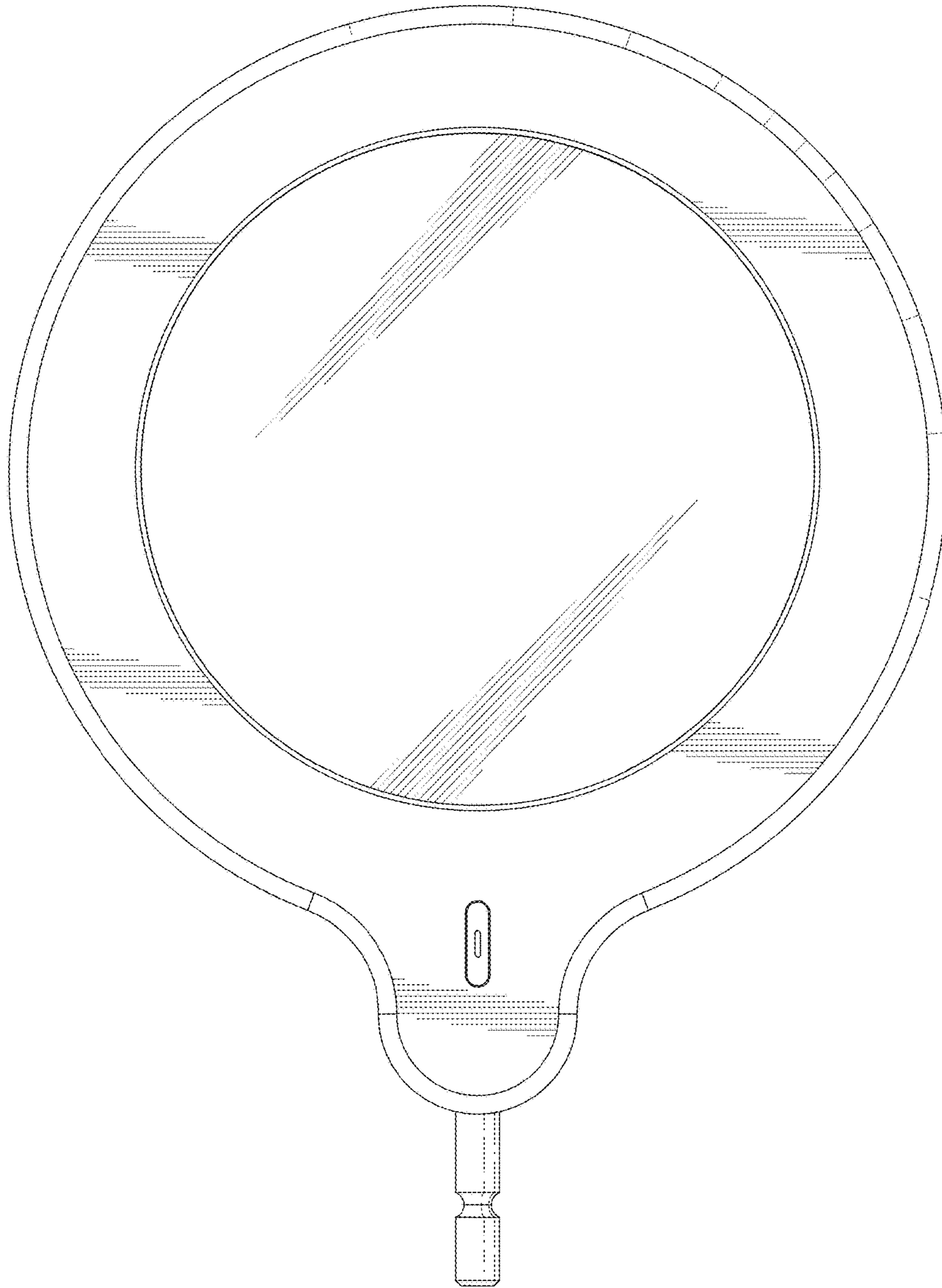

FIG. 6

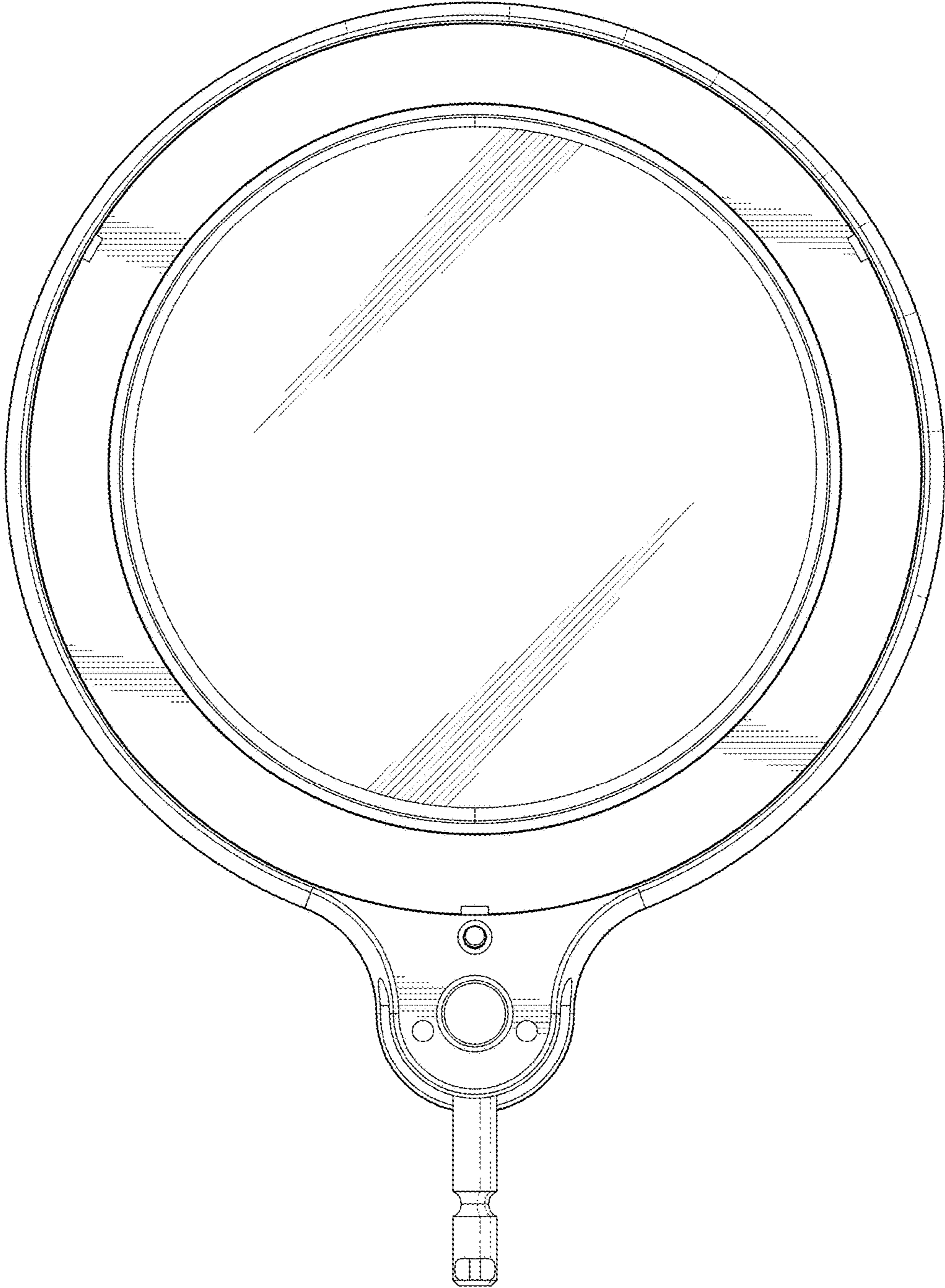

FIG. 7