



US00D843422S

(12) **United States Design Patent** (10) **Patent No.:** **US D843,422 S**
Choi et al. (45) **Date of Patent:** **** Mar. 19, 2019**

(54) **DOOR FOR REFRIGERATOR**

F25D 29/00; F25D 25/02; F25D 25/024;
F25D 27/005;

(71) Applicant: **LG ELECTRONICS INC.**, Seoul
(KR)

(Continued)

(72) Inventors: **Kyukwan Choi**, Seoul (KR); **Daesung Lee**, Seoul (KR); **Jihyun Lee**, Seoul (KR); **Hyungki Kim**, Seoul (KR)

(56) **References Cited**

U.S. PATENT DOCUMENTS

D243,985 S * 4/1977 Brown D15/85
D244,019 S * 4/1977 Brown D15/85

(Continued)

(73) Assignee: **LG ELECTRONICS INC.**, Seoul
(KR)

Primary Examiner — Richard E Chilcot

(74) *Attorney, Agent, or Firm* — Birch, Stewart, Kolasch & Birch, LLP

(**) Term: **15 Years**

(57) **CLAIM**

The ornamental design for a door for refrigerator, as shown and described.

(21) Appl. No.: **35/503,252**

DESCRIPTION

(22) Filed: **Dec. 19, 2016**

(80) **Hague Agreement Data**

Int. Filing Date: **Dec. 19, 2016**

Int. Reg. No.: **DM/094060**

Int. Reg. Date: **Dec. 19, 2016**

Int. Reg. Pub. Date: **Jun. 23, 2017**

(30) **Foreign Application Priority Data**

Jul. 1, 2016 (KR) 30-2016-0032295

(51) **LOC (11) Cl.** **15-07**

(52) **U.S. Cl.**
USPC **D15/91**

(58) **Field of Classification Search**
USPC D15/79-91
CPC F25D 23/028; F25D 23/02; F25D 25/025;
F25D 23/00; F25D 2323/021; F25D
11/00; F25D 2323/024; F25D 23/04;

1. Door for refrigerator
1.1 is a rear perspective view of a door for refrigerator, showing our new design;
1.2 is a rear elevation view thereof;
1.3 is a front elevation view thereof;
1.4 is a right-side elevation view thereof;
1.5 is a left-side elevation view thereof;
1.6 is a top plan view thereof;
1.7 is a bottom plan view thereof;
1.8 is a rear perspective view thereof, in a use condition;
1.9 is a rear perspective view of the door for refrigerator, when a cover of the inner door is opened;
1.10 is a rear elevation view thereof;
1.11 is a front elevation view thereof;
1.12 is a right-side elevation view thereof;
1.13 is a left-side elevation view thereof;
1.14 is a top plan view thereof;
1.15 is a bottom plan view thereof;
1.16 is a rear perspective view thereof, in a use condition;
1.17 is a perspective view of the door for refrigerator, when the outer door is opened;
1.18 is a front elevation view thereof;
1.19 is a rear elevation view thereof;

(Continued)

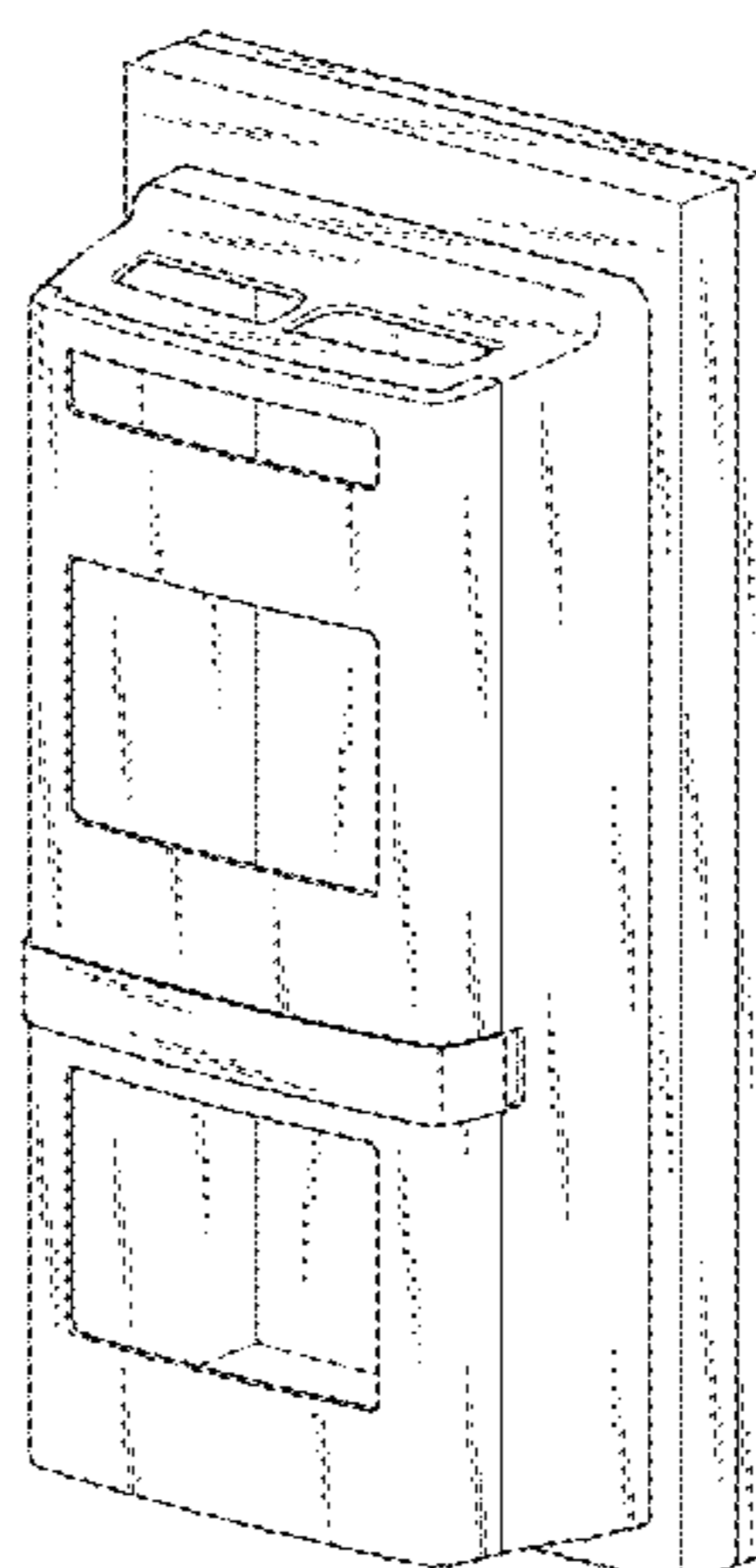

1.20 is a left-side elevation view thereof;
 1.21 is a right-side elevation view thereof;
 1.22 is a top plan view thereof;
 1.23 is a bottom plan view thereof; and
 1.24 is a perspective view thereof, in a use condition.
 The broken lines shown in the drawing figures are included for the purpose of illustrating environment and form no part of the claimed design.

1 Claim, 24 Drawing Sheets

- (52) **U.S. Cl.**
 CPC *F25D 23/02* (2013.01)
- (58) **Field of Classification Search**
 CPC F25D 23/12; F25D 29/005; F25D 17/042;
 F25D 2325/021
 See application file for complete search history.

(56) **References Cited**

U.S. PATENT DOCUMENTS

D271,107	S	*	10/1983	Trulaske	D15/85
D453,169	S	*	1/2002	Ma	D15/81
D467,596	S	*	12/2002	Kim	D15/81
D468,325	S	*	1/2003	Lorek	D15/81
D478,601	S	*	8/2003	Becke F25D 25/02	D15/81
D487,278	S	*	3/2004	Segers F25D 11/00	D15/86
D493,181	S	*	7/2004	Kehoe	D15/81
D512,081	S	*	11/2005	Chang	D15/81
D513,014	S	*	12/2005	Seki	D15/81
D519,133	S	*	4/2006	Chang	D15/81
D524,830	S	*	7/2006	Lei	D15/81

D539,312	S	*	3/2007	Kim	D15/81
D540,831	S	*	4/2007	Kim	D15/81
D541,315	S	*	4/2007	Trulaske, Sr.	D15/81
D550,256	S	*	9/2007	Lei	D15/81
D604,340	S	*	11/2009	Kim	D15/81
D615,565	S	*	5/2010	Kristiansen	D15/86
D627,374	S	*	11/2010	Yang	D15/81
D629,022	S	*	12/2010	Cho	D15/85
D630,231	S	*	1/2011	Yang	D15/81
D654,098	S	*	2/2012	Piffl	D15/81
D656,967	S	*	4/2012	Yi	D15/86
D660,886	S	*	5/2012	Piffl	D15/91
D673,189	S	*	12/2012	Kwak	D15/86
D681,075	S	*	4/2013	Yi	D15/86
D687,076	S	*	7/2013	Schaefer	D15/81
D691,644	S	*	10/2013	Cho	D15/86
D695,795	S	*	12/2013	Schaefer	D15/81
D698,371	S	*	1/2014	Brenneis	D15/81
D701,539	S	*	3/2014	Saejin	D15/85
D702,739	S	*	4/2014	Kim	D15/86
D704,981	S	*	5/2014	Gates	D7/332
D705,278	S	*	5/2014	Schaefer	D15/81
D705,279	S	*	5/2014	Schaefer	D15/81
D705,824	S	*	5/2014	Schaefer	D15/81
D724,629	S	*	3/2015	Choi	D15/85
D729,286	S	*	5/2015	Kwak	D15/85
D732,584	S	*	6/2015	Sin	D15/86
D742,434	S	*	11/2015	Yeo	D15/86
D767,648	S	*	9/2016	Shoemaker	D15/86
D775,245	S	*	12/2016	Seo	D15/81
D776,726	S	*	1/2017	Mauffette	D15/81
D781,931	S	*	3/2017	Sherman	D15/80
D794,684	S	*	8/2017	Mauffette	D15/81
D803,602	S	*	11/2017	Hightower	D6/663
D814,215	S	*	4/2018	Yan	D6/660
2007/0228909	A1	*	10/2007	Hwang F25D 25/024	312/408
2008/0047209	A1	*	2/2008	Hinterholzer A47F 3/0434	52/208

* cited by examiner

1.1

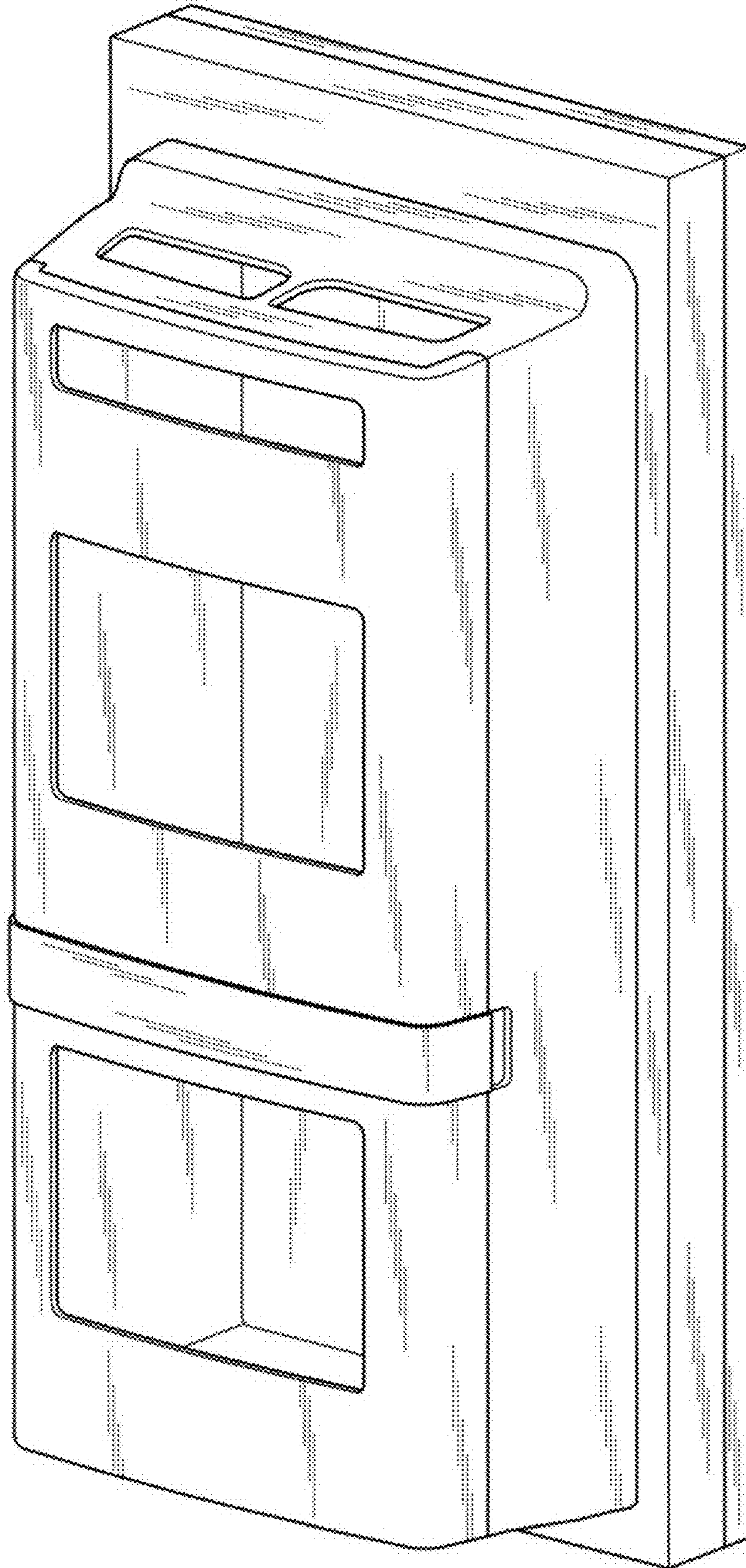

1.2

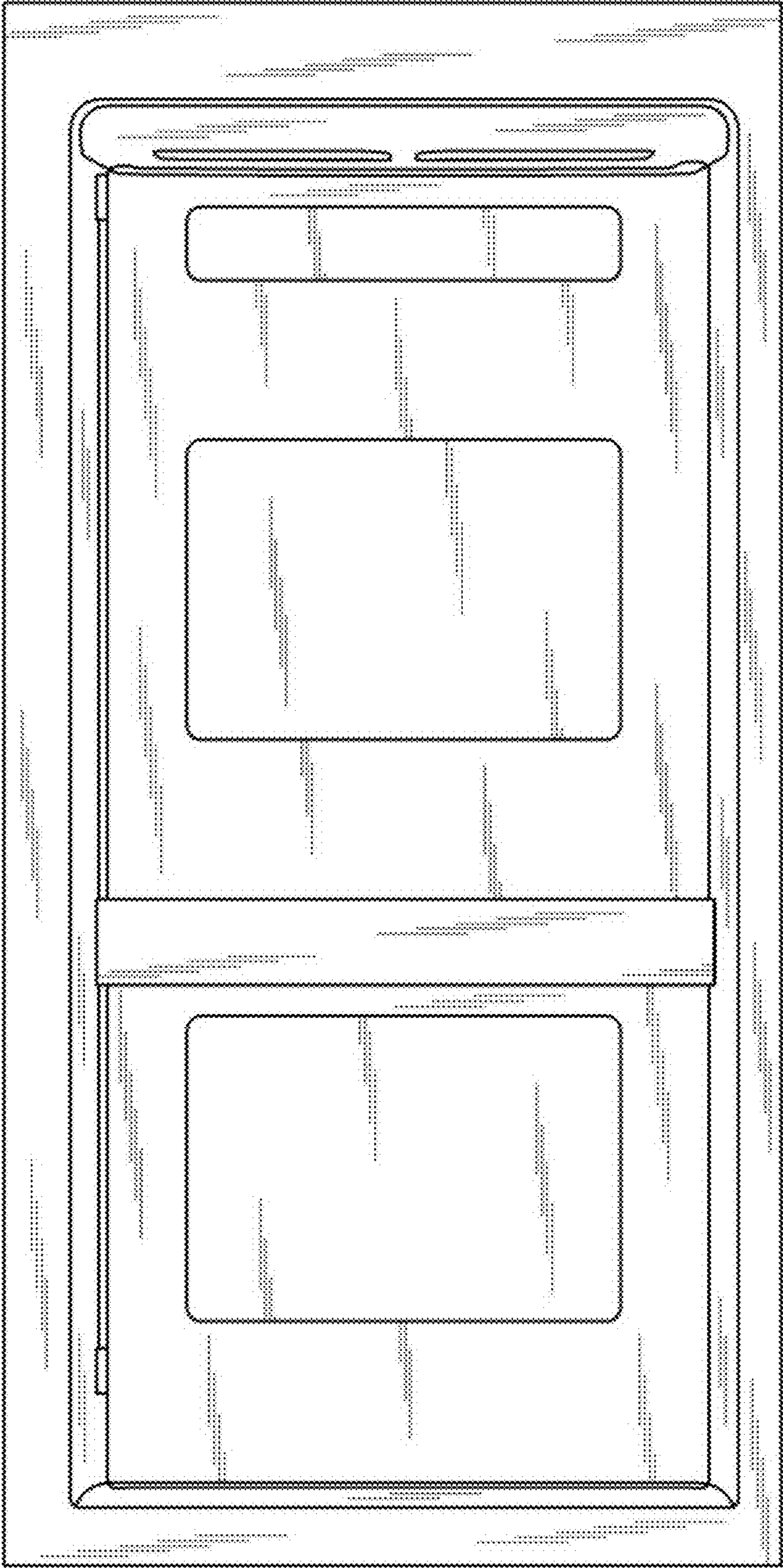

1.3

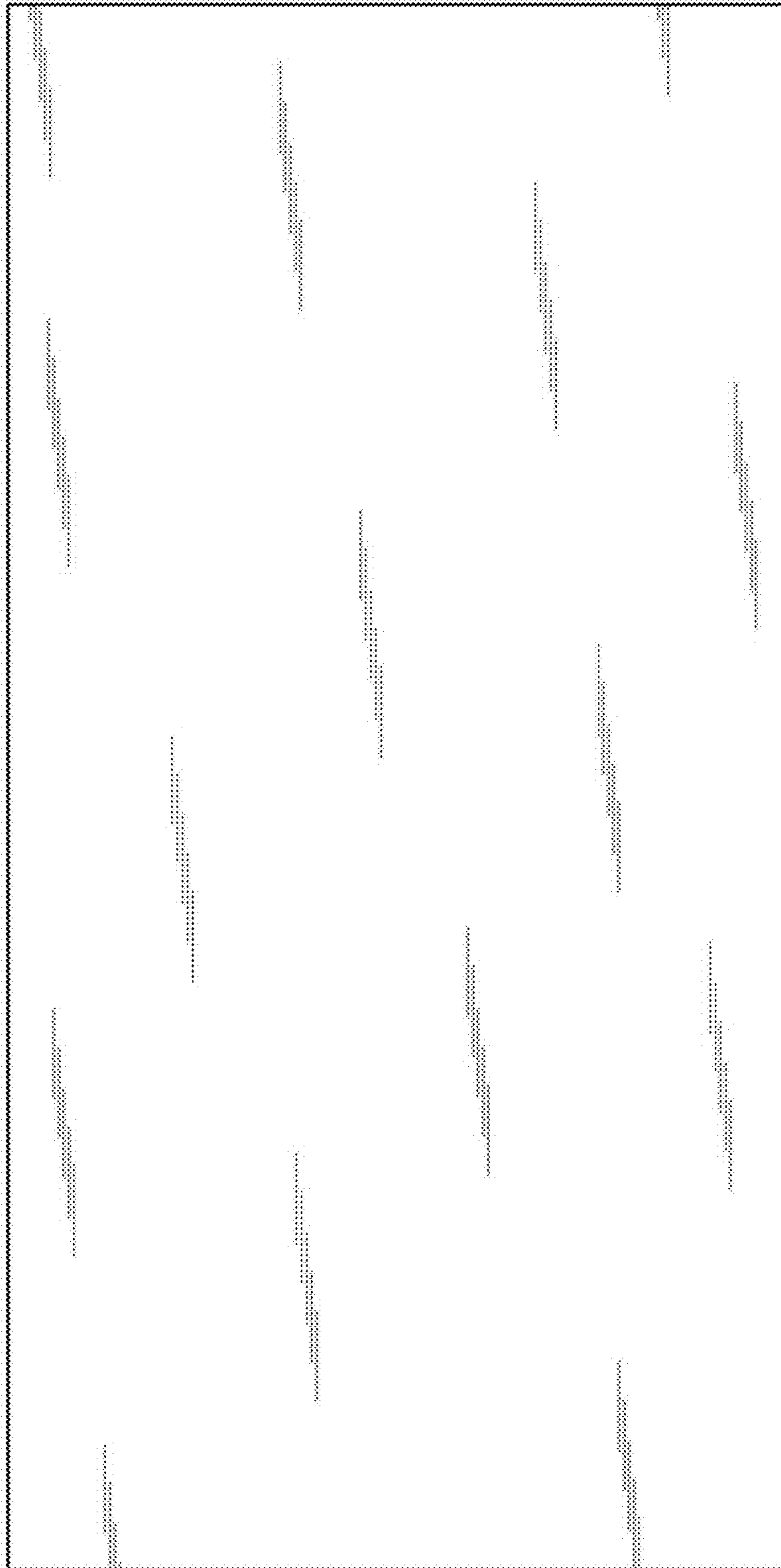

1.4

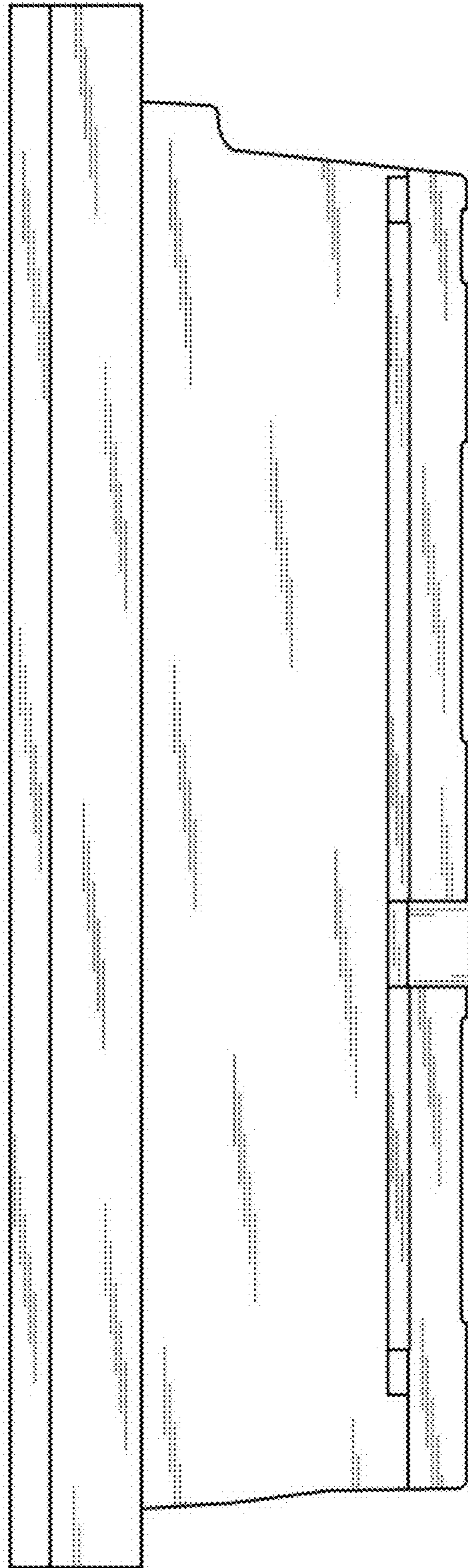

1.5

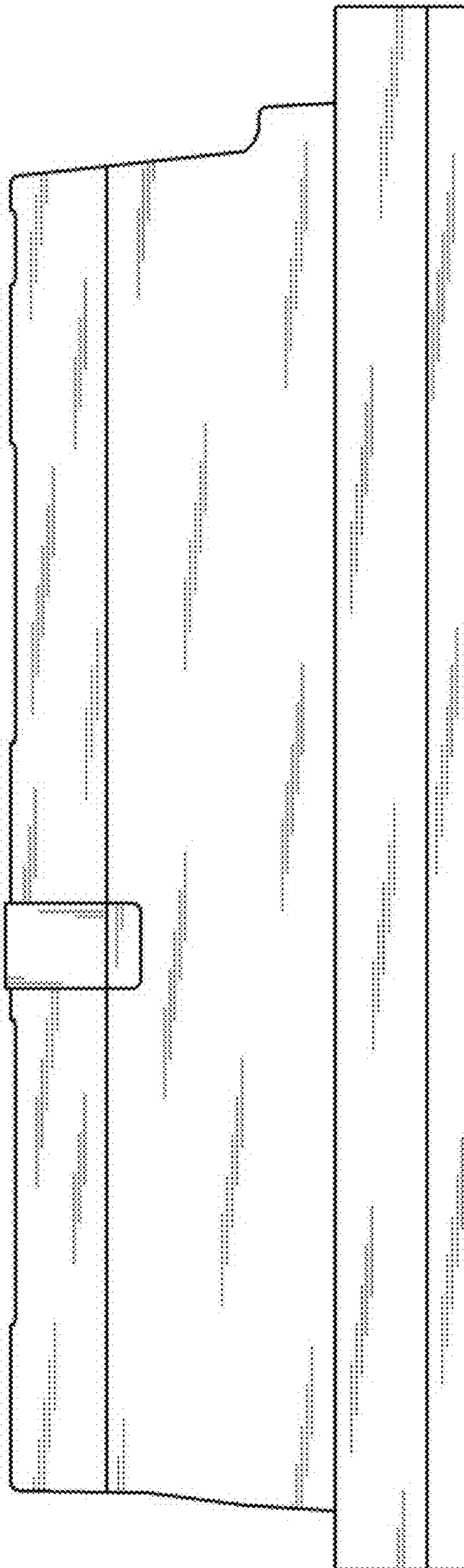

1.6

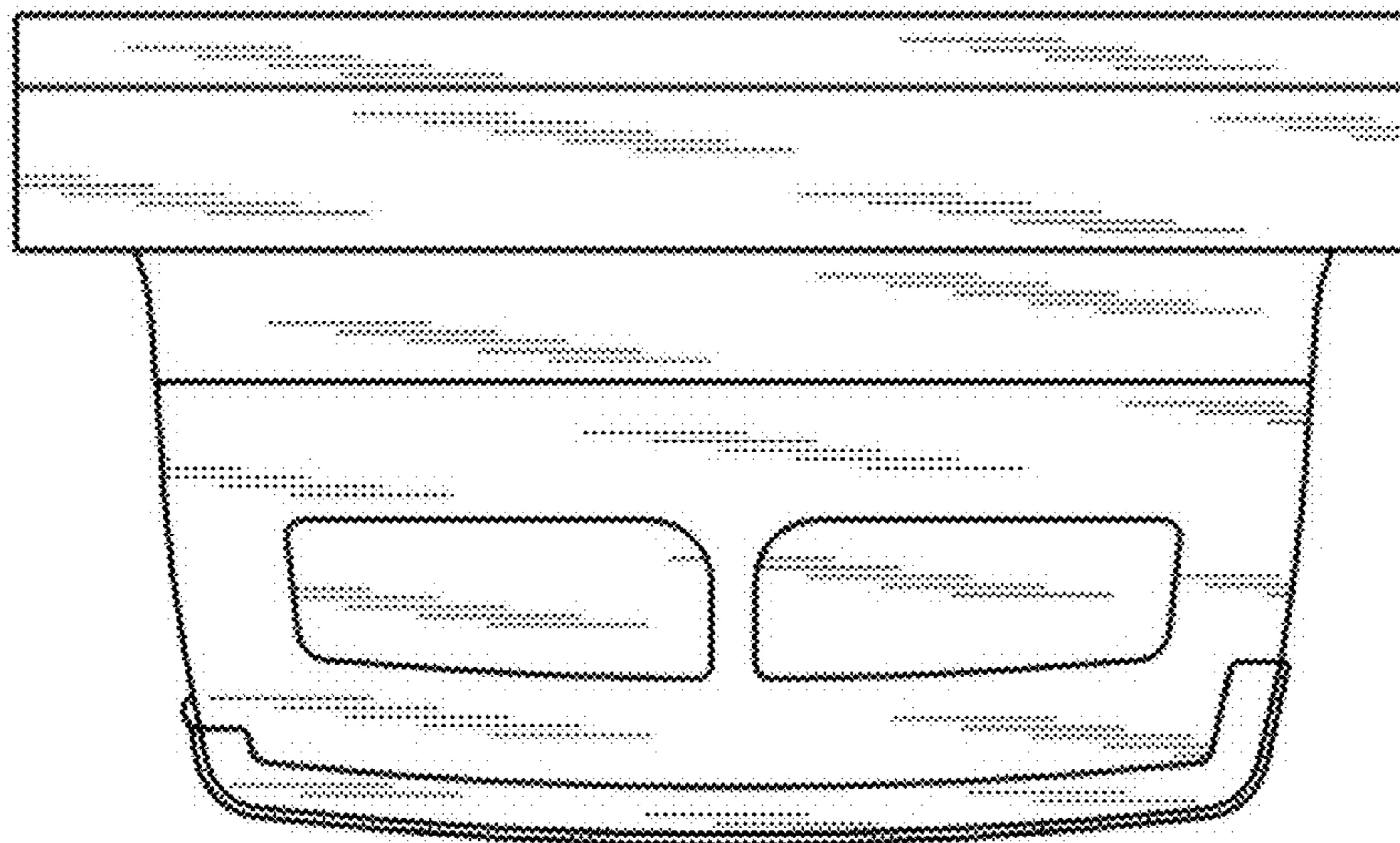

1.7

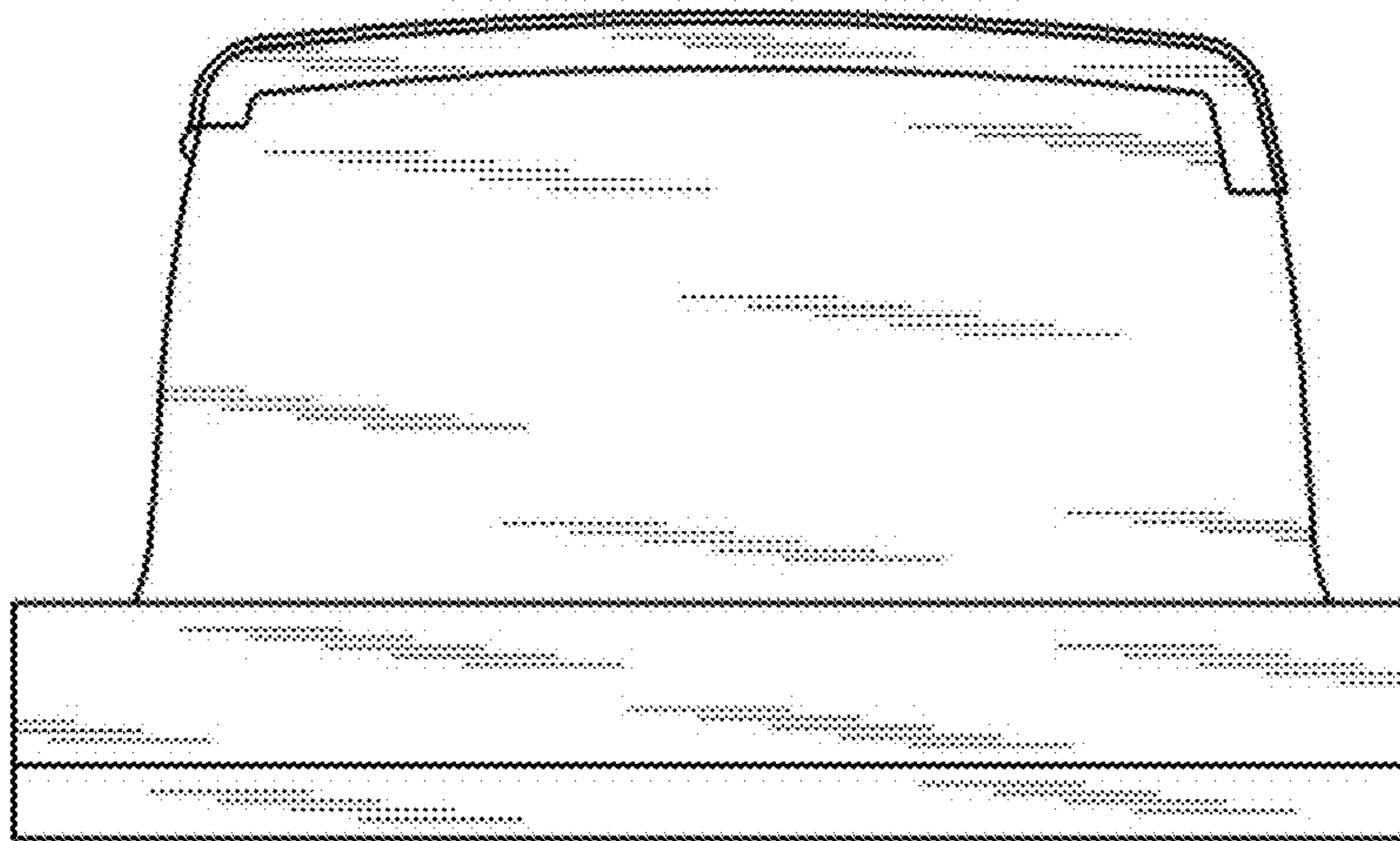

1.8

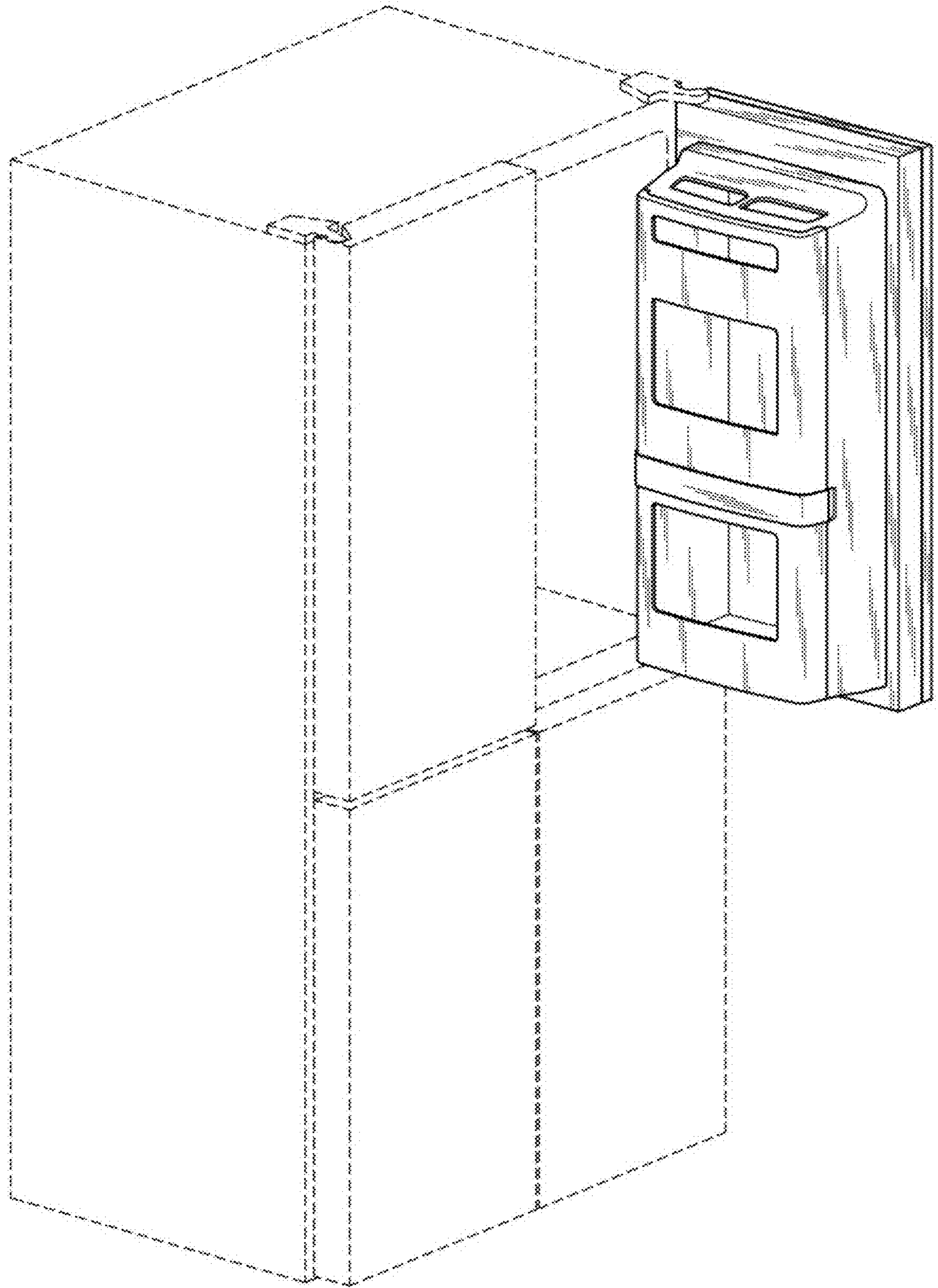

1.9



1.10

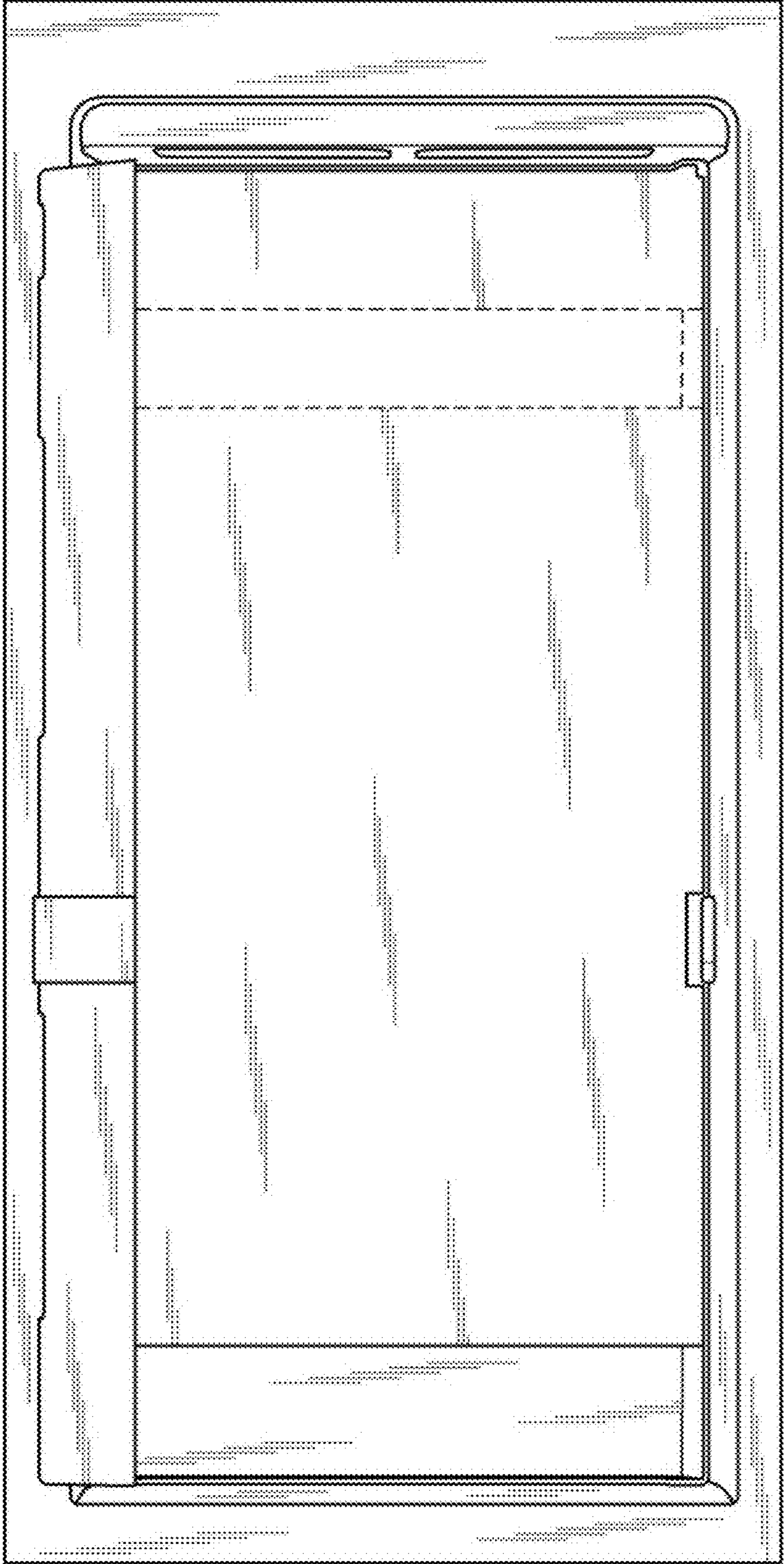

1.11



1.12

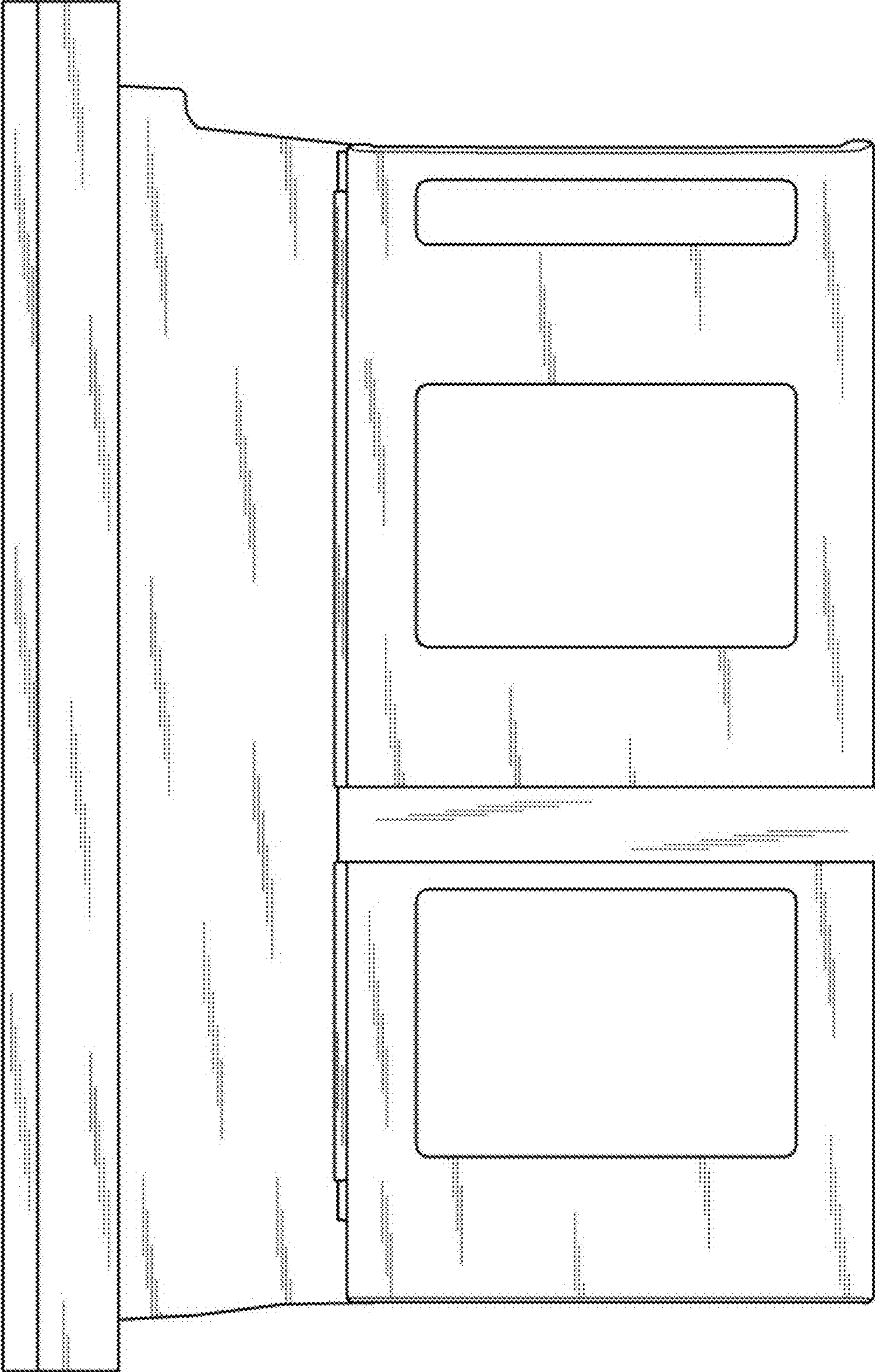

1.13

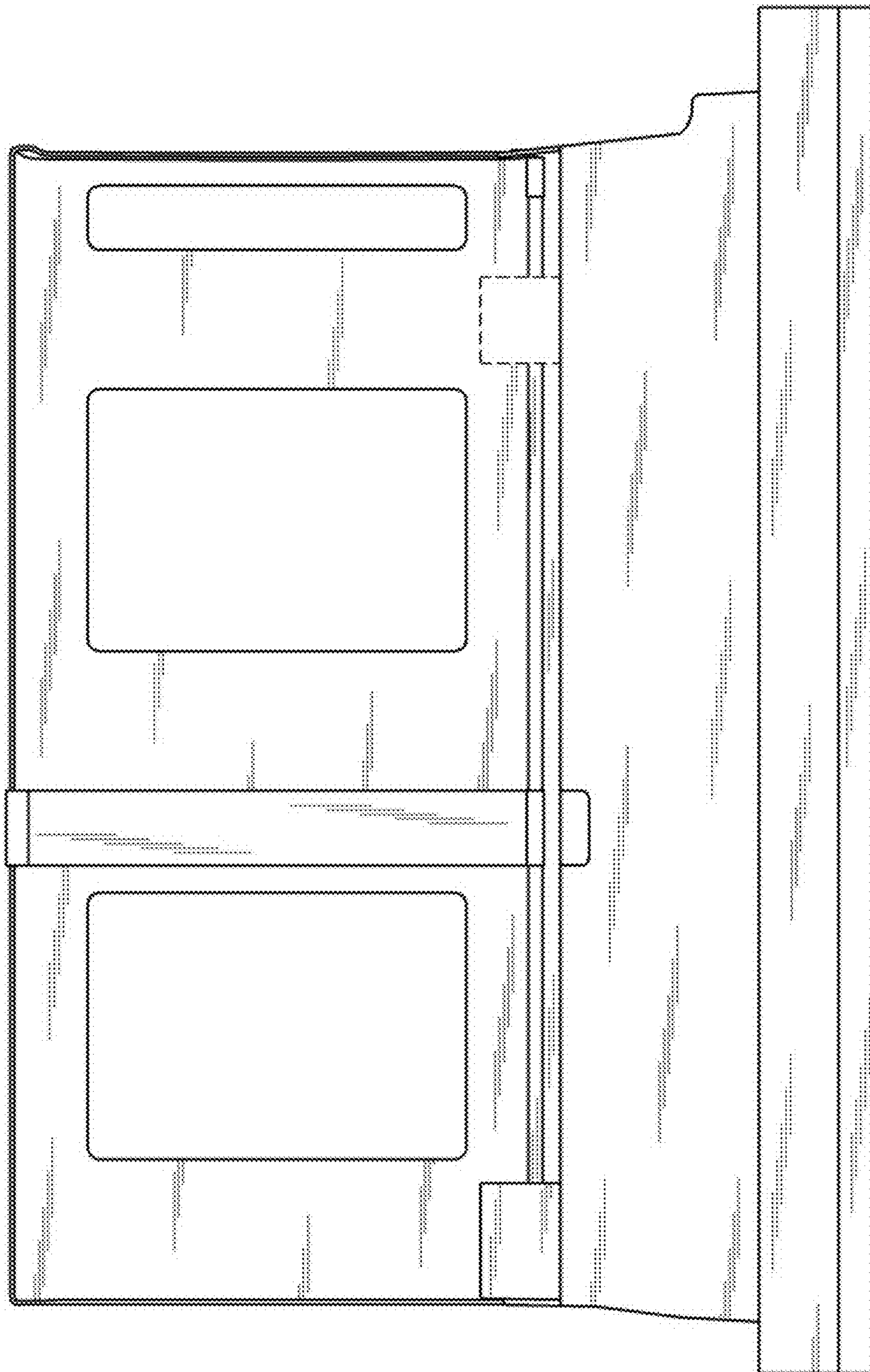

1.14

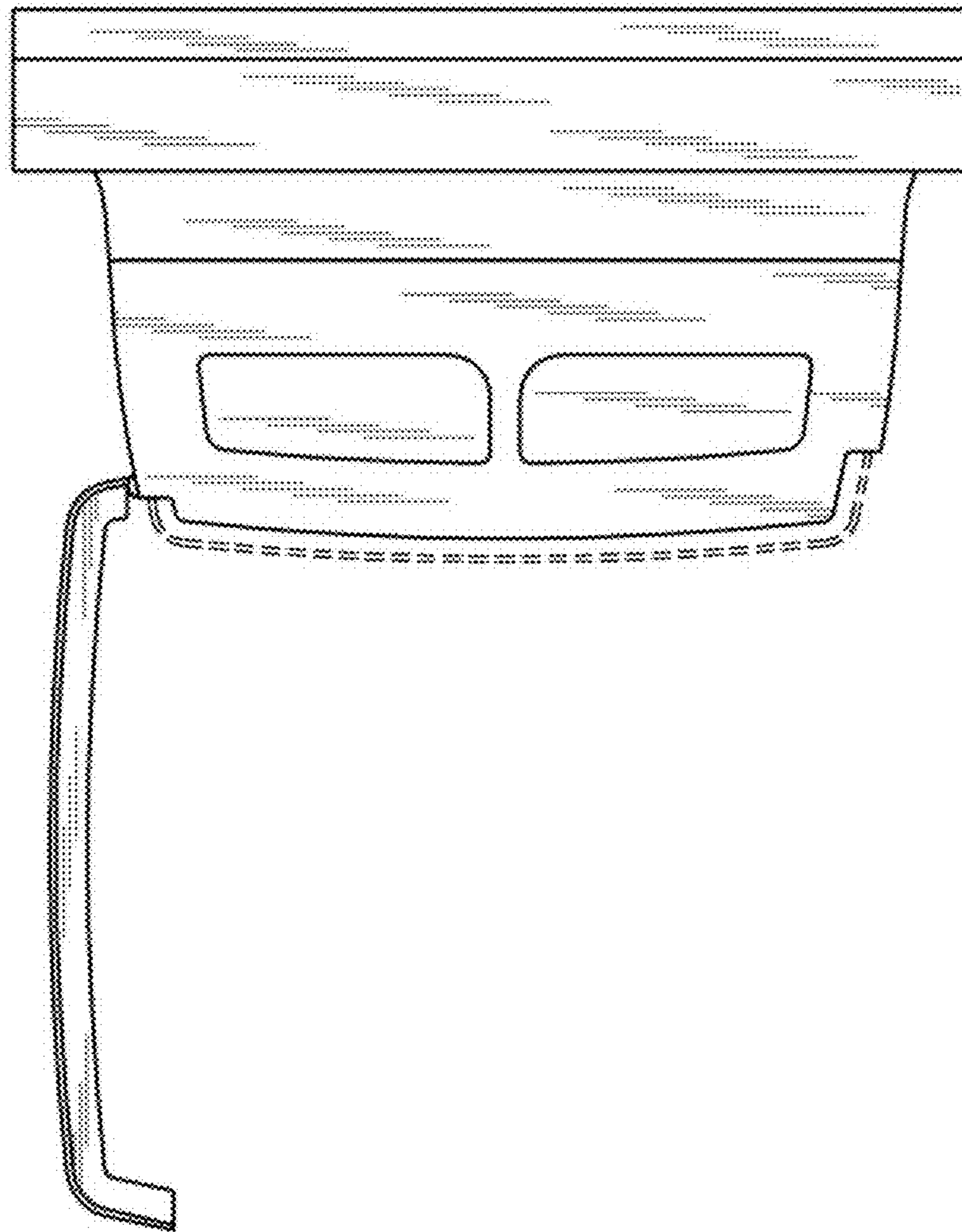

1.15

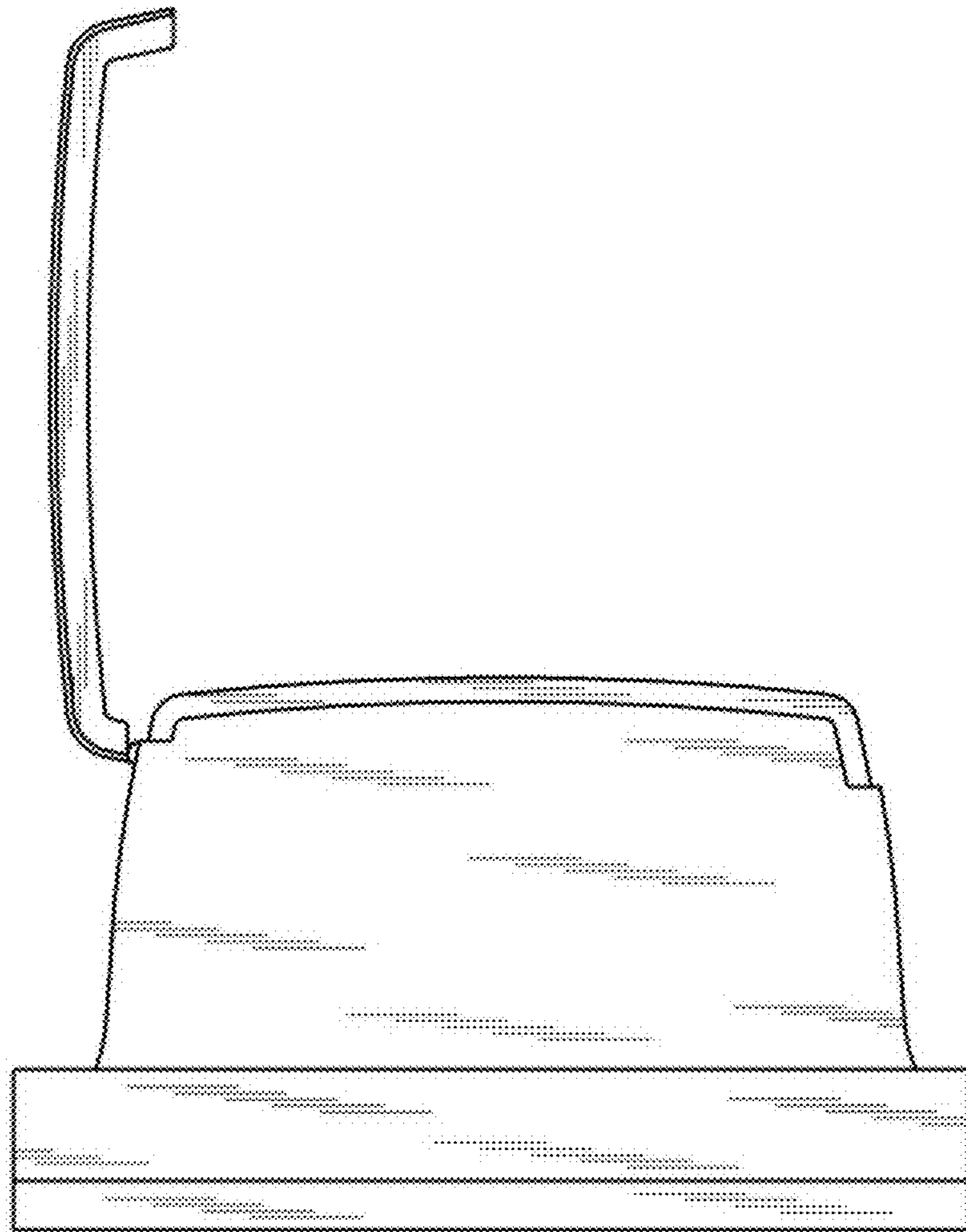

1.16

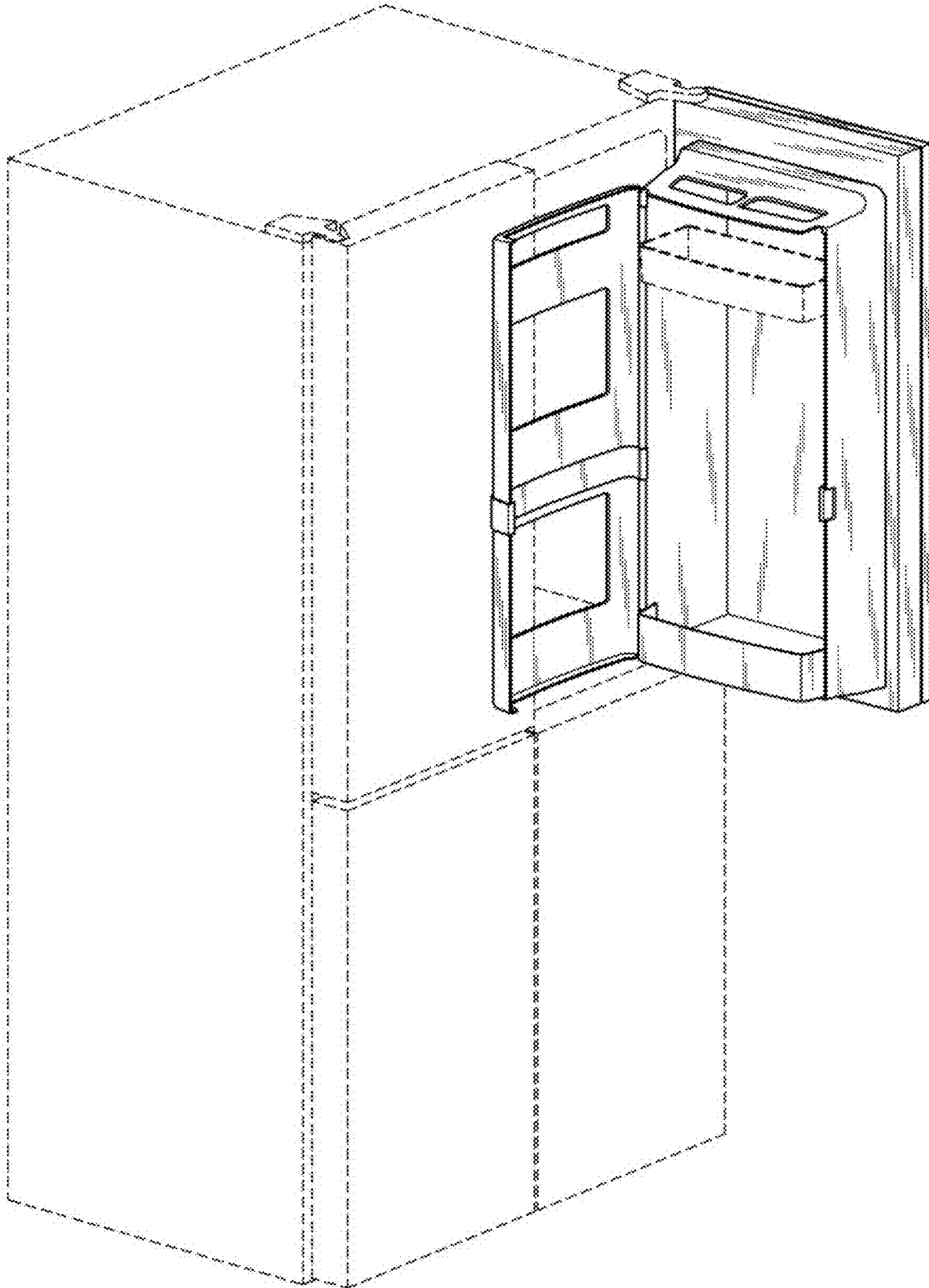

1.17

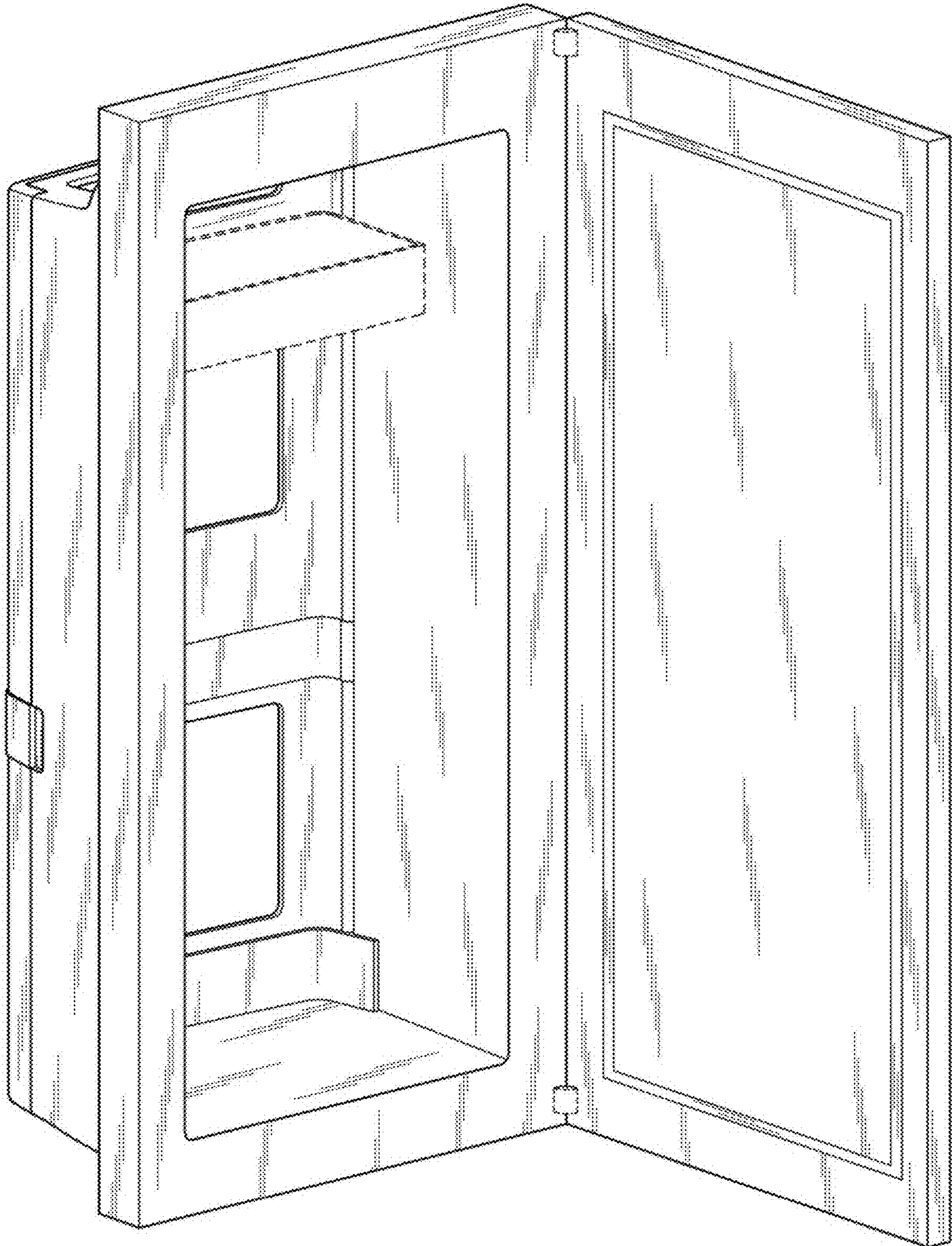

1.18

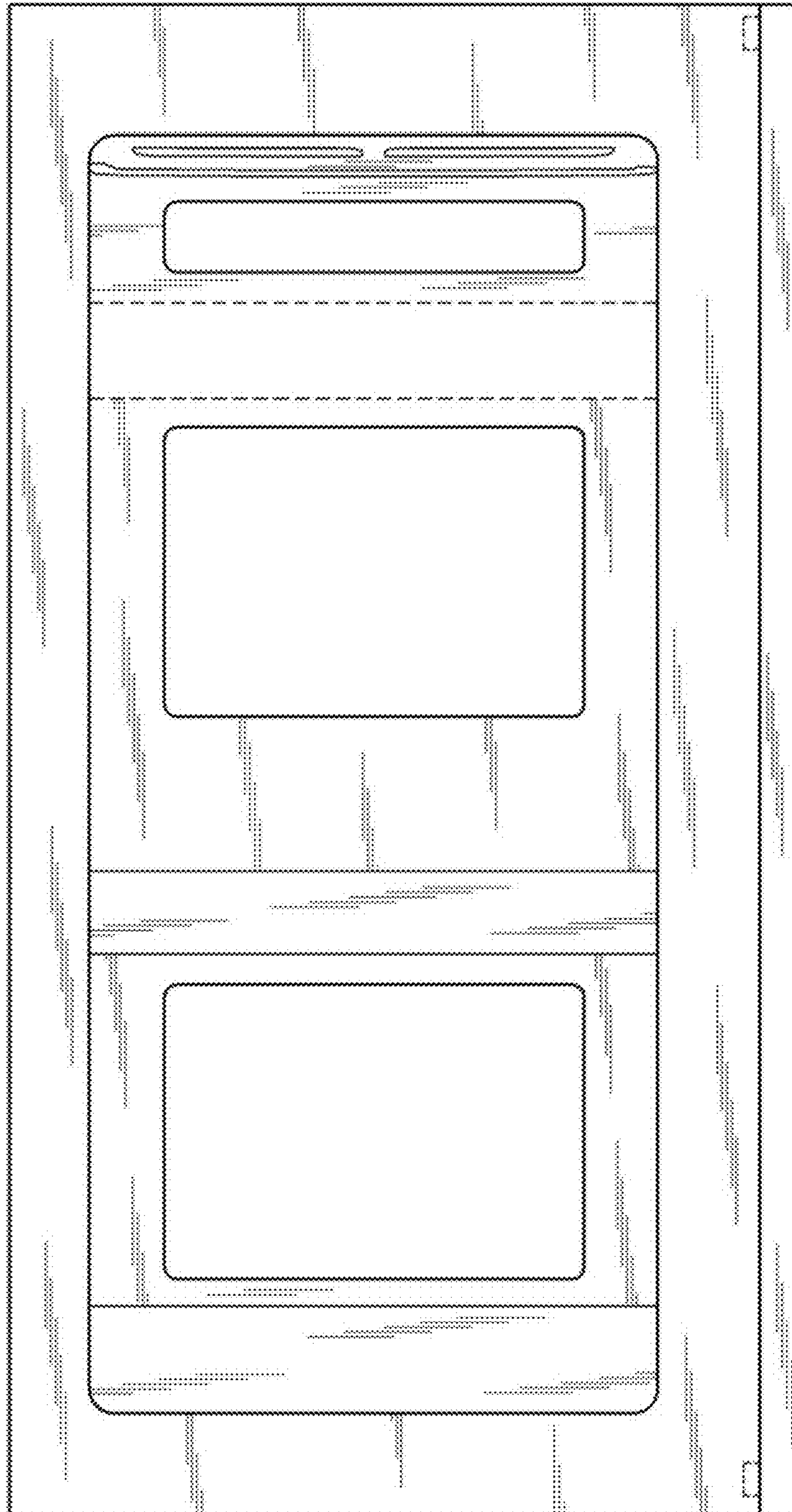

1.19

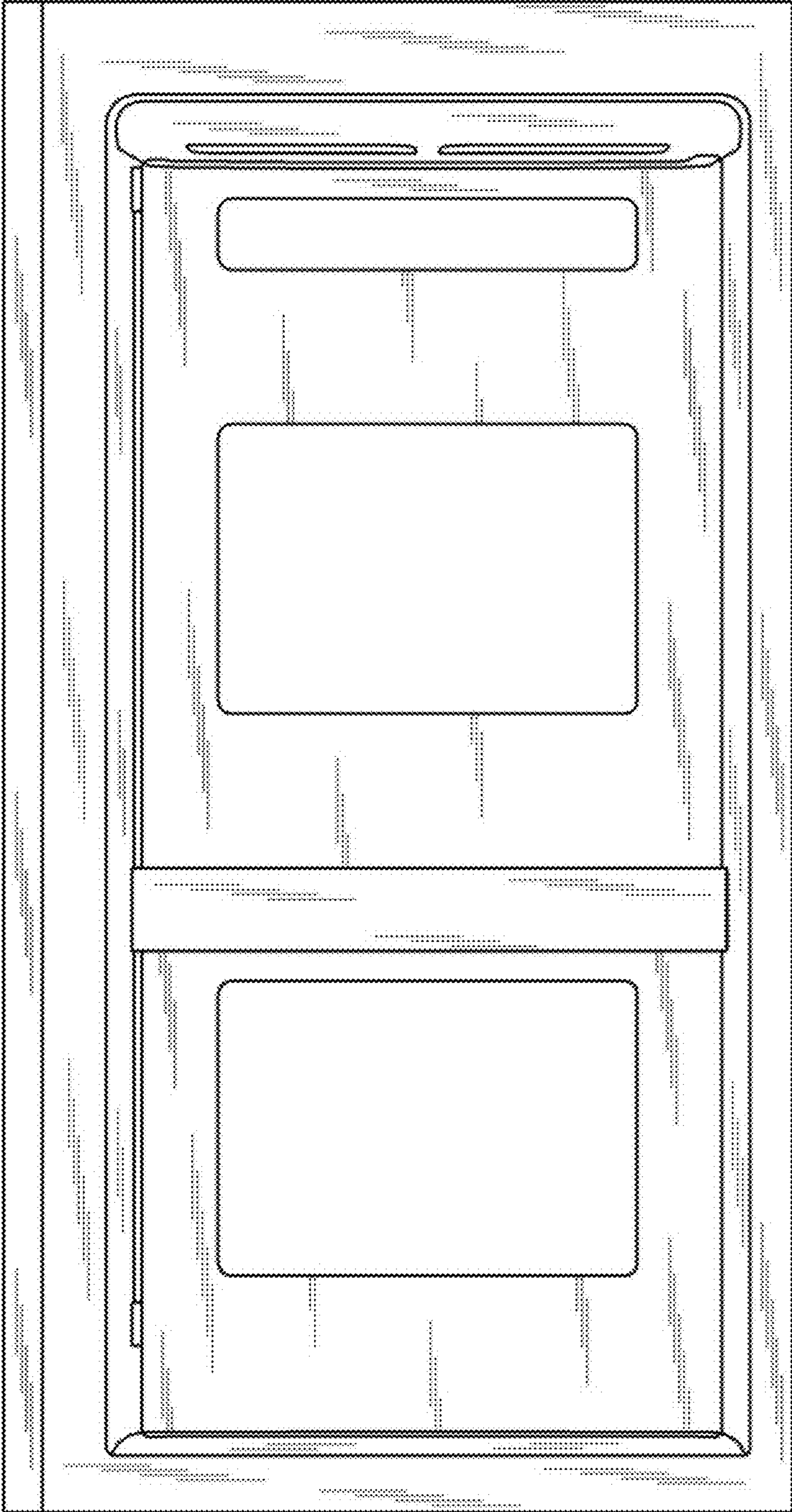

1.20

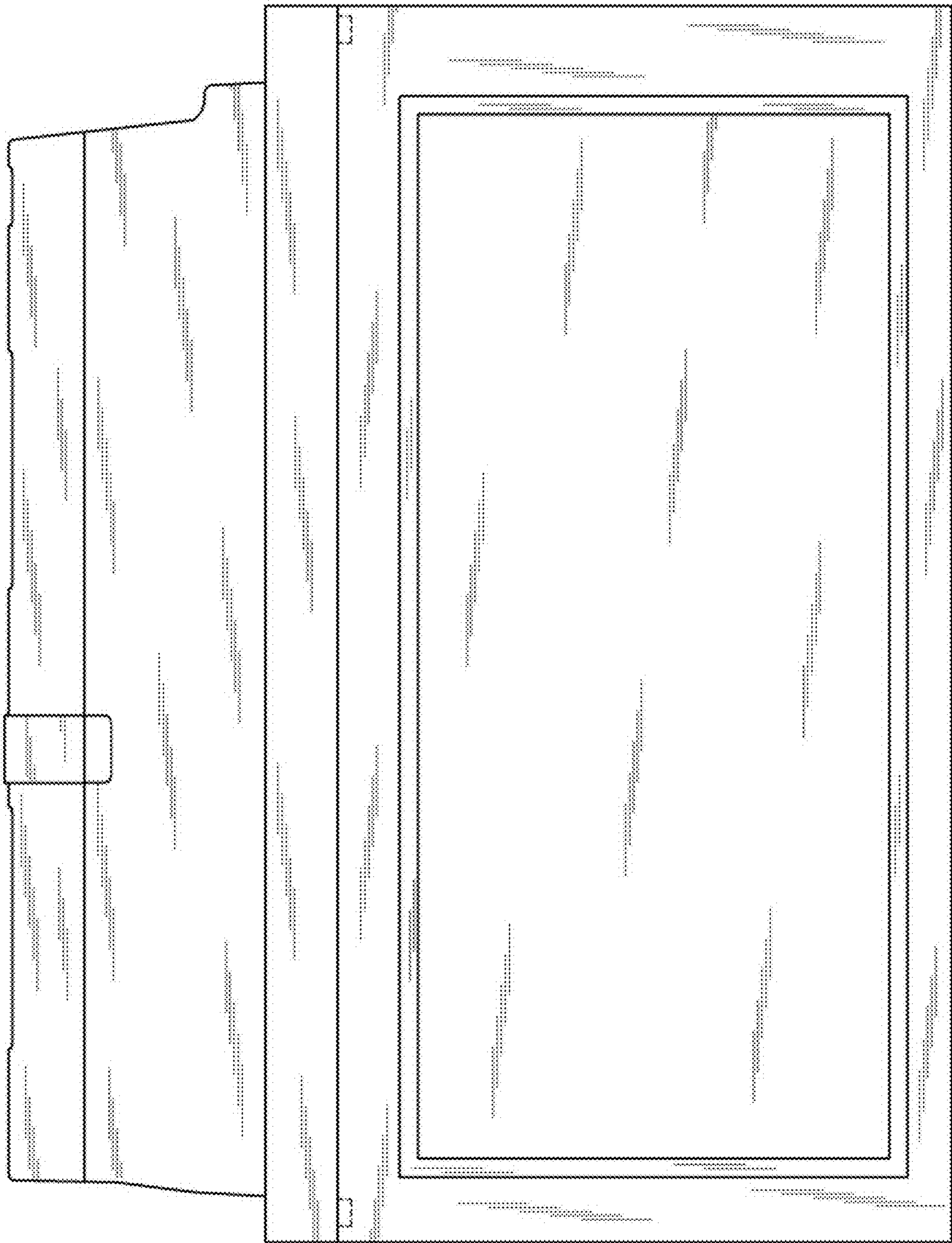

1.21

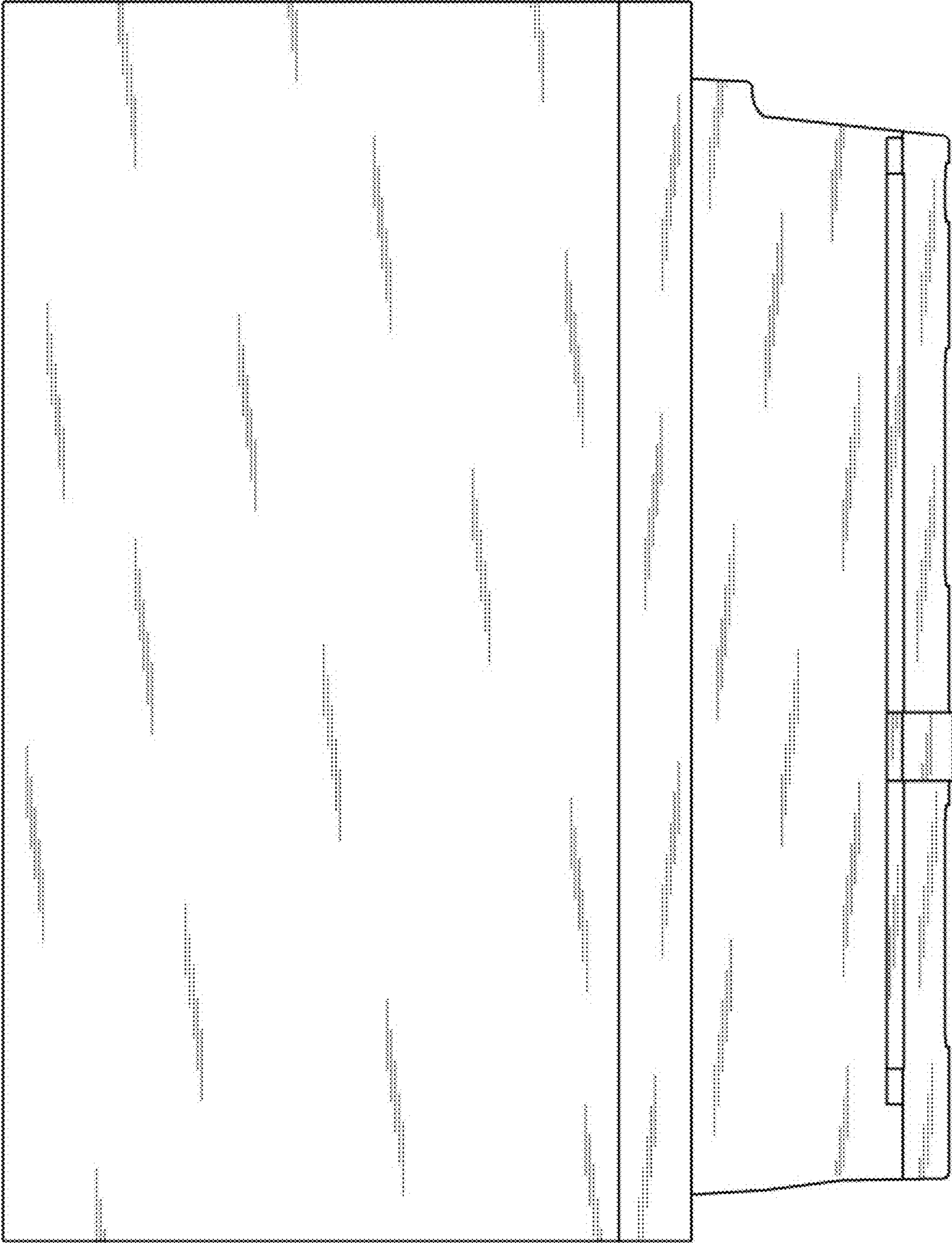

1.22

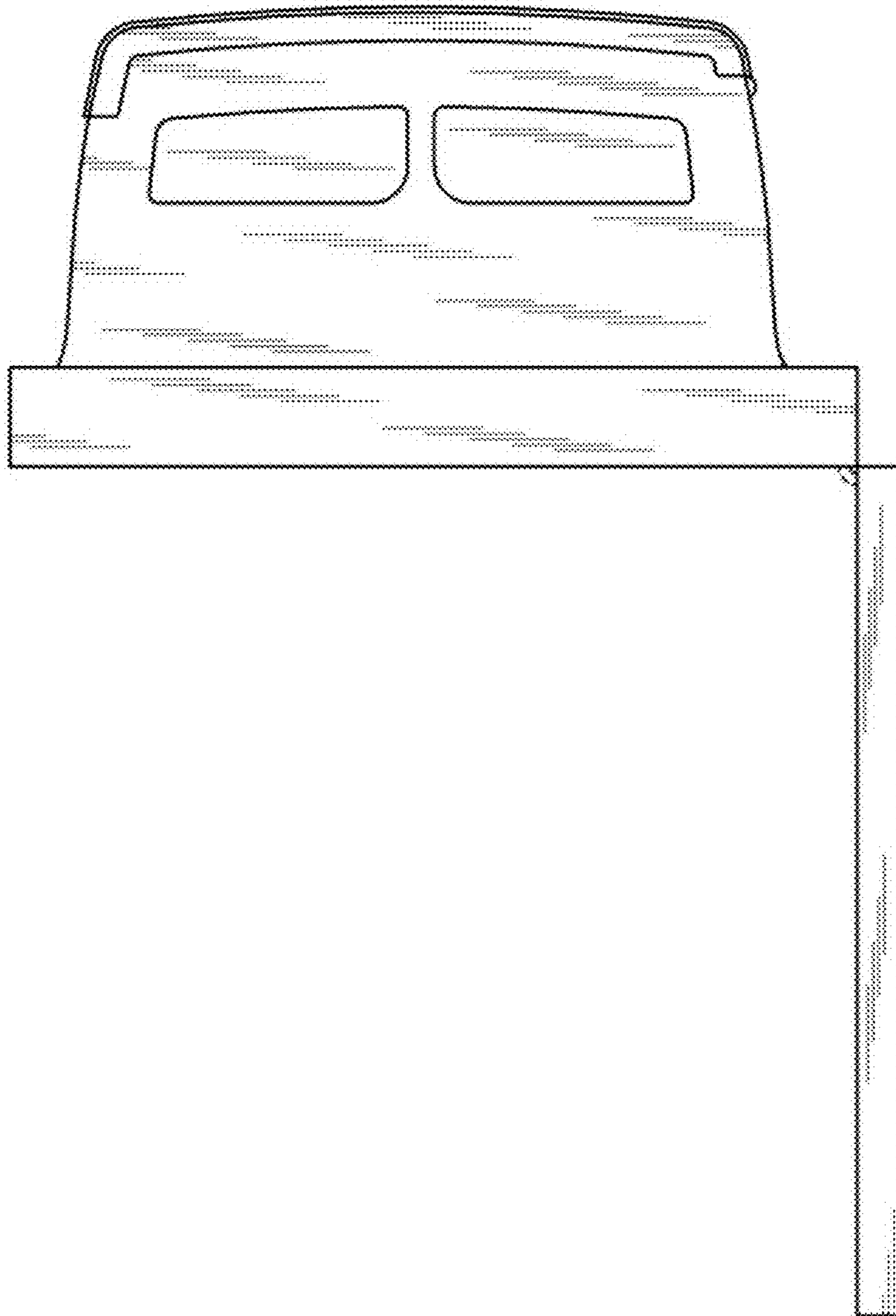

1.23

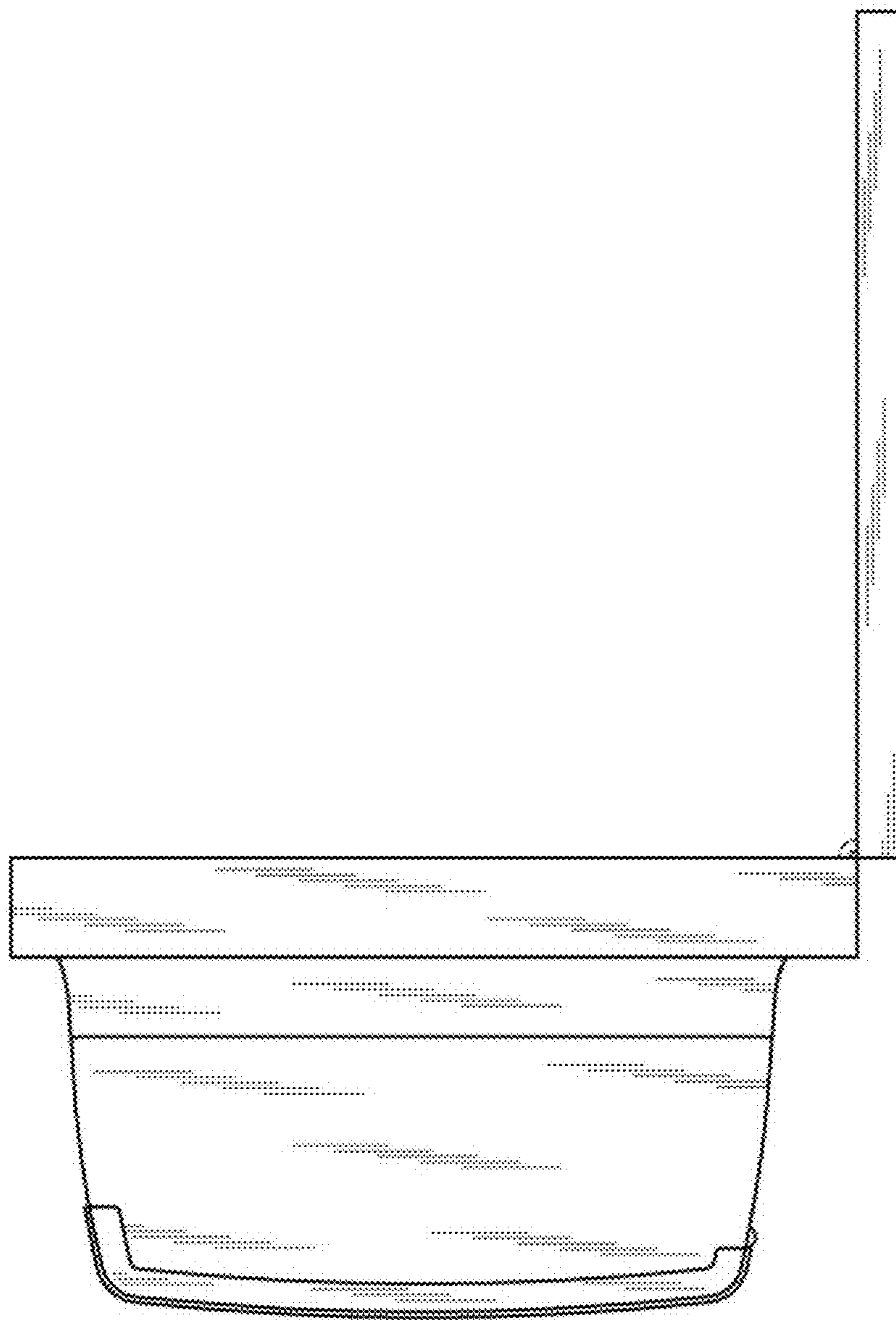

1.24

