



US00D843178S

(12) **United States Design Patent** (10) **Patent No.:** **US D843,178 S**
Furneau et al. (45) **Date of Patent:** **** Mar. 19, 2019**

(54) **WINE BOTTLE COOLER**
(71) Applicant: **Sovaro Coolers, LLC**, Roswell, GA (US)
(72) Inventors: **Todd McLean Furneau**, Roswell, GA (US); **Michael Thuma**, La Grange, IL (US); **Michael R. Vogler**, Oswego, IL (US)
(73) Assignee: **Sovaro Coolers, LLC**, Roswell, GA (US)
(**) Term: **15 Years**
(21) Appl. No.: **29/592,975**
(22) Filed: **Feb. 3, 2017**
(51) **LOC (11) Cl.** **07-07**
(52) **U.S. Cl.**
USPC **D7/603**
(58) **Field of Classification Search**
USPC D7/509, 523, 603-608, 624.1-624.3;
D9/500-504, 515, 549, 559, 572-575
CPC B65D 81/3881; B65D 81/3886; A47G
23/0241; A47G 23/0266; A47G 23/2288
See application file for complete search history.

D786,025 S * 5/2017 Seiders D7/606
D793,172 S * 8/2017 Medina D7/624.2
D795,017 S * 8/2017 Freeman D7/584
D801,545 S * 10/2017 Wiesli D24/224
D801,753 S * 11/2017 Piper D7/624.2
D805,352 S * 12/2017 Thuma D7/523

OTHER PUBLICATIONS

Double Wall Insulated Wine Chiller. Online, published date unknown. Retrieved on Dec. 4, 2017 from URL: <https://shop.nordstrom.com/s/sovaro-double-wall-insulated-wine-chiller/4694230>.*

* cited by examiner

Primary Examiner — Karen S Acker
Assistant Examiner — Omeed Agilee
(74) *Attorney, Agent, or Firm* — McHale & Slavin, P.A.

(57) **CLAIM**

The ornamental design for a wine bottle cooler, as shown and described.

DESCRIPTION

FIG. 1 is a top left isometric view of the wine bottle cooler of the present invention;
FIG. 2 is a front view thereof;
FIG. 3 is a rear view thereof;
FIG. 4 is a left side view thereof;
FIG. 5 is a right side view thereof;
FIG. 6 is a bottom view thereof;
FIG. 7 is a top view thereof;
FIG. 8 is a bottom right isometric view thereof; and,
FIG. 9 is a top isometric view thereof, illustrating a wine bottle in the wine bottle cooler.
The broken lines shown in FIG. 7 and the areas within them depict portions of the wine bottle cooler that form no part of the claimed design. The broken lines shown in FIG. 9 depict environmental subject matter that forms no part of the claimed design.

1 Claim, 9 Drawing Sheets

(56) **References Cited**

U.S. PATENT DOCUMENTS

D122,691 S * 9/1940 Nicholson D7/530
D376,284 S * 12/1996 Keeley D6/520
D517,869 S * 3/2006 Graves D7/300.1
D557,074 S * 12/2007 Bardolet D7/509
D601,836 S * 10/2009 Carr D6/525
D612,213 S * 3/2010 LaChance D7/607
D621,223 S * 8/2010 Bas D7/603
D623,984 S * 9/2010 Bas D11/146
D660,084 S * 5/2012 Gilbert D7/510
D709,337 S * 7/2014 Miller D7/606
D709,643 S * 7/2014 Kohler D26/138
D780,533 S * 3/2017 Seiders D7/608

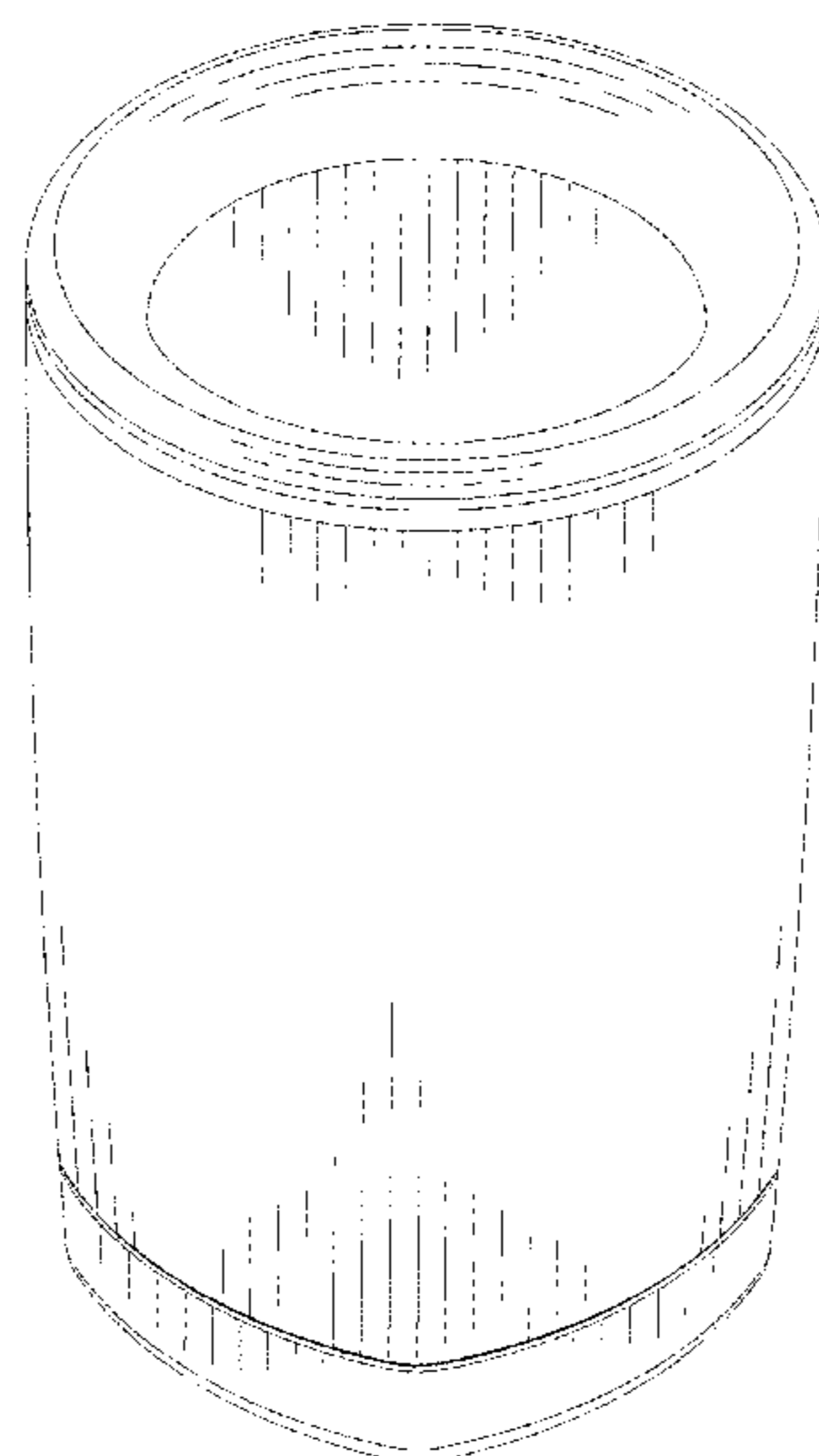

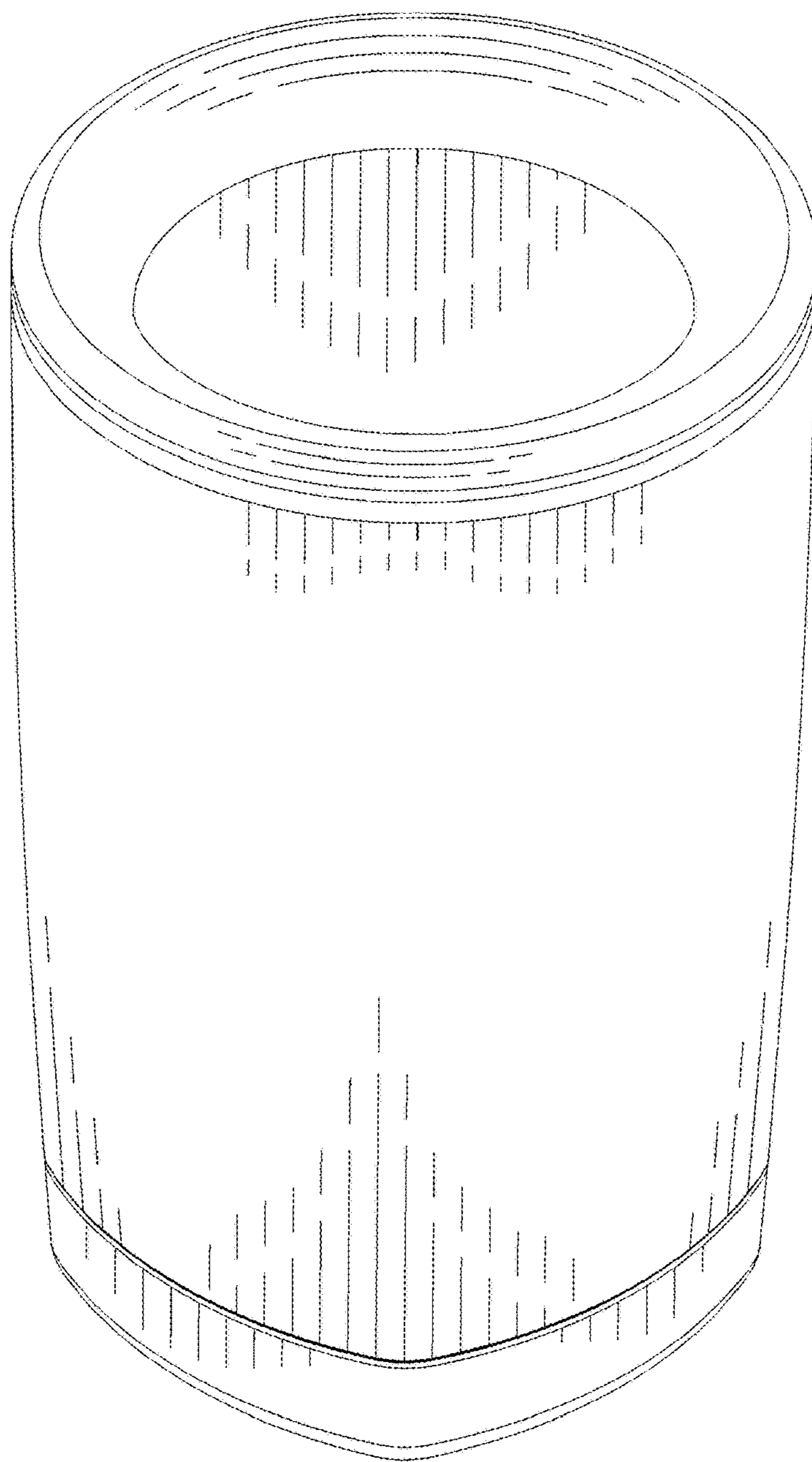

Fig. 1

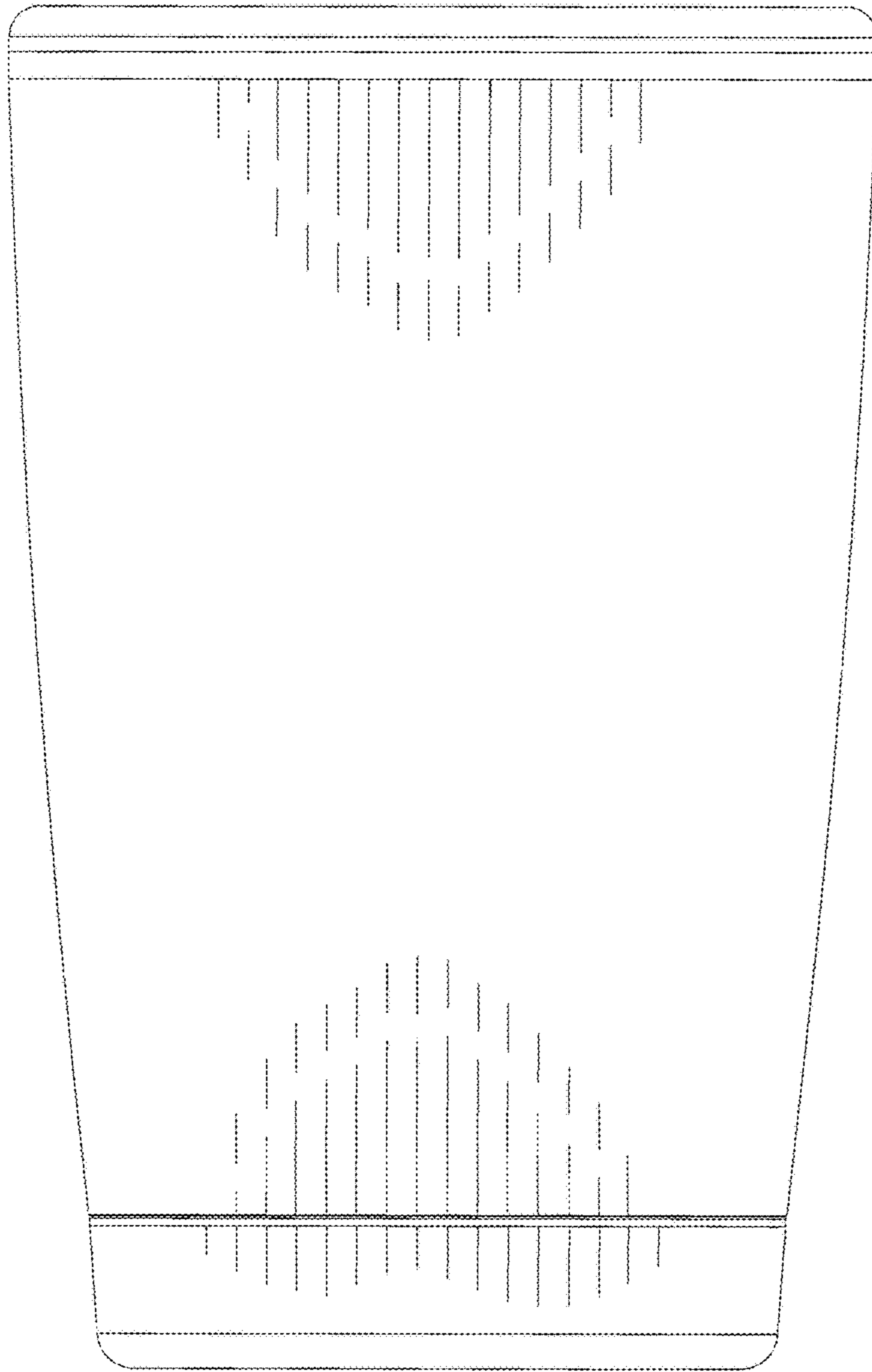

Fig. 2

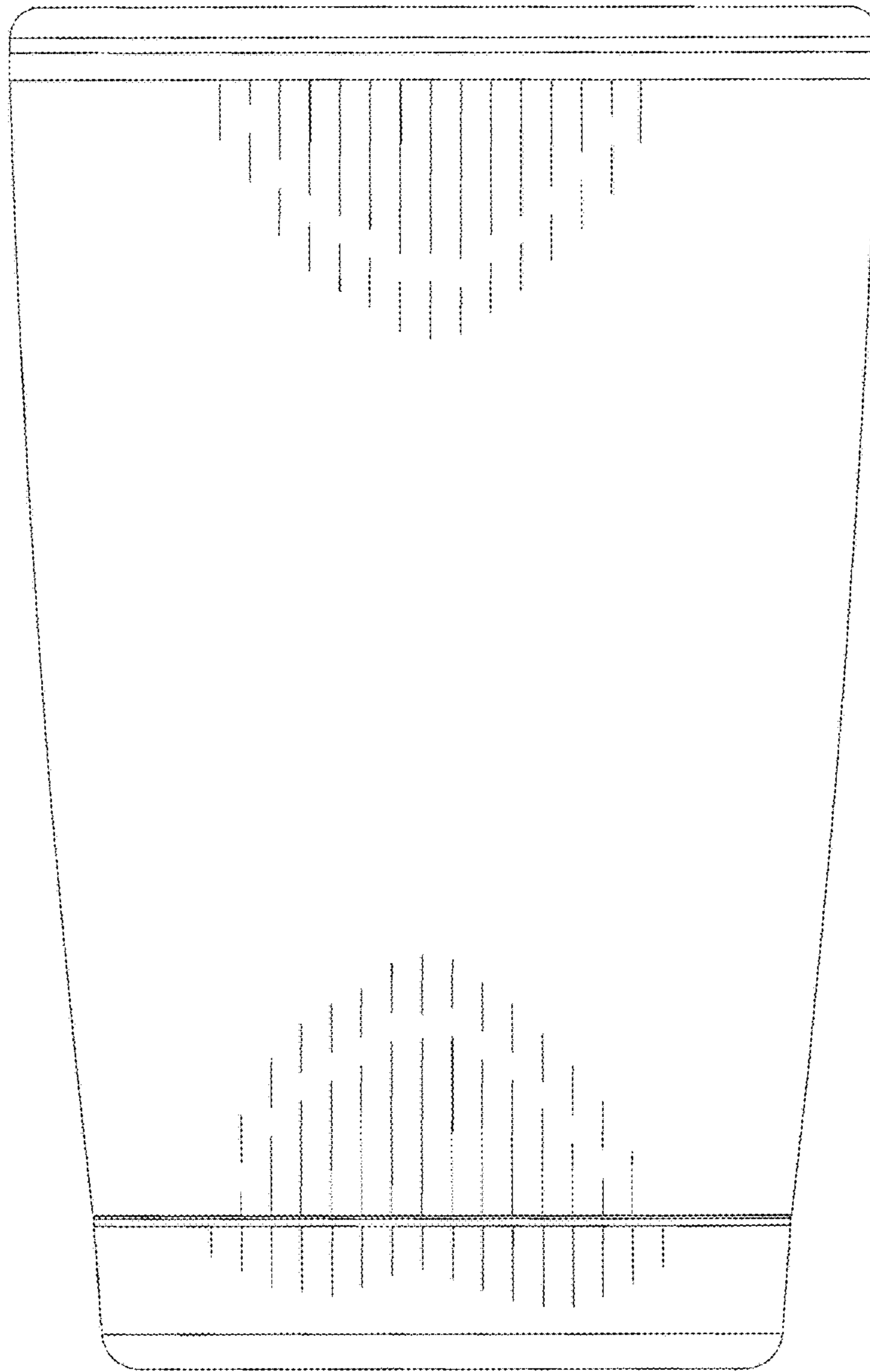

Fig. 3

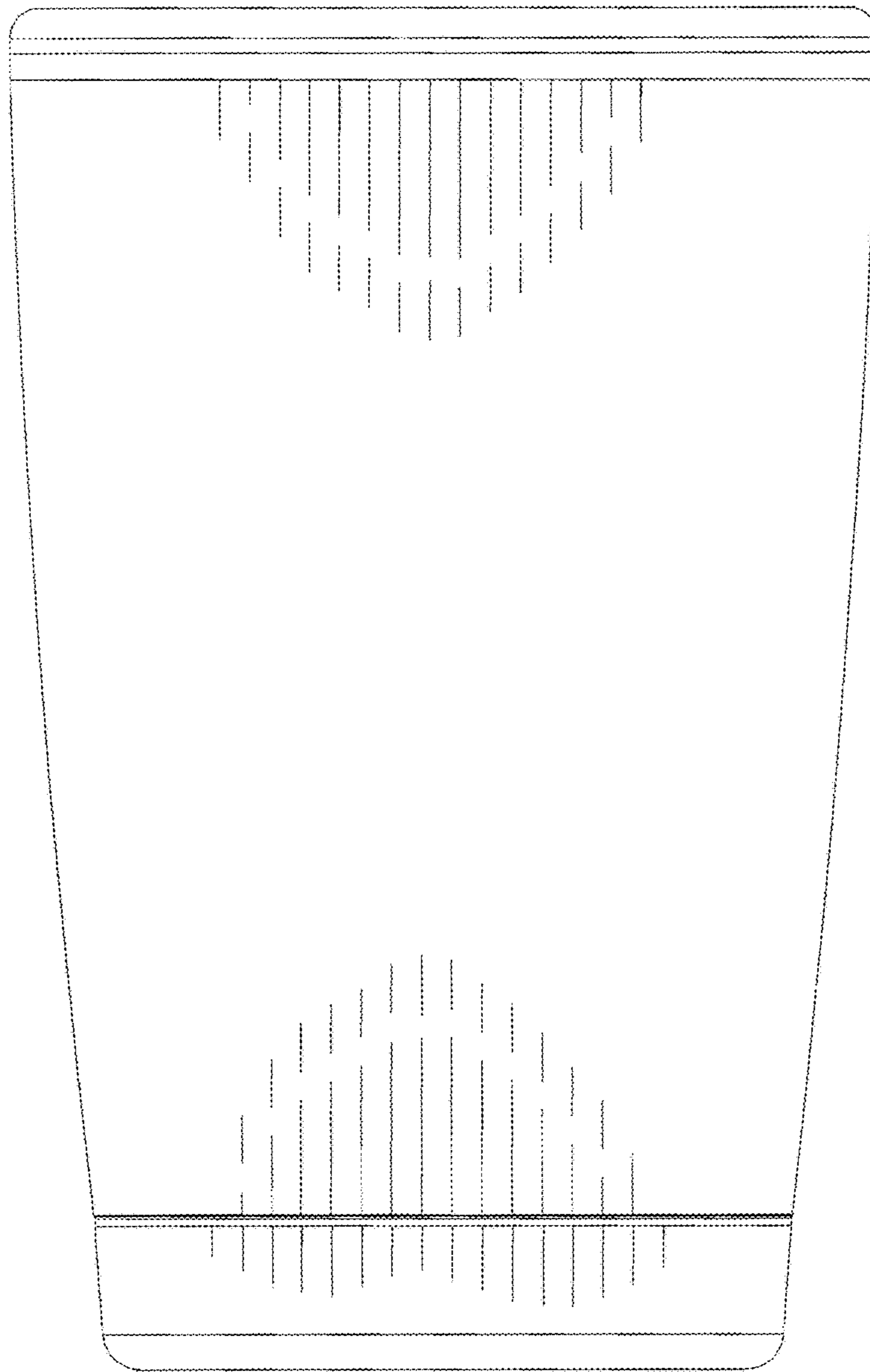

Fig. 4

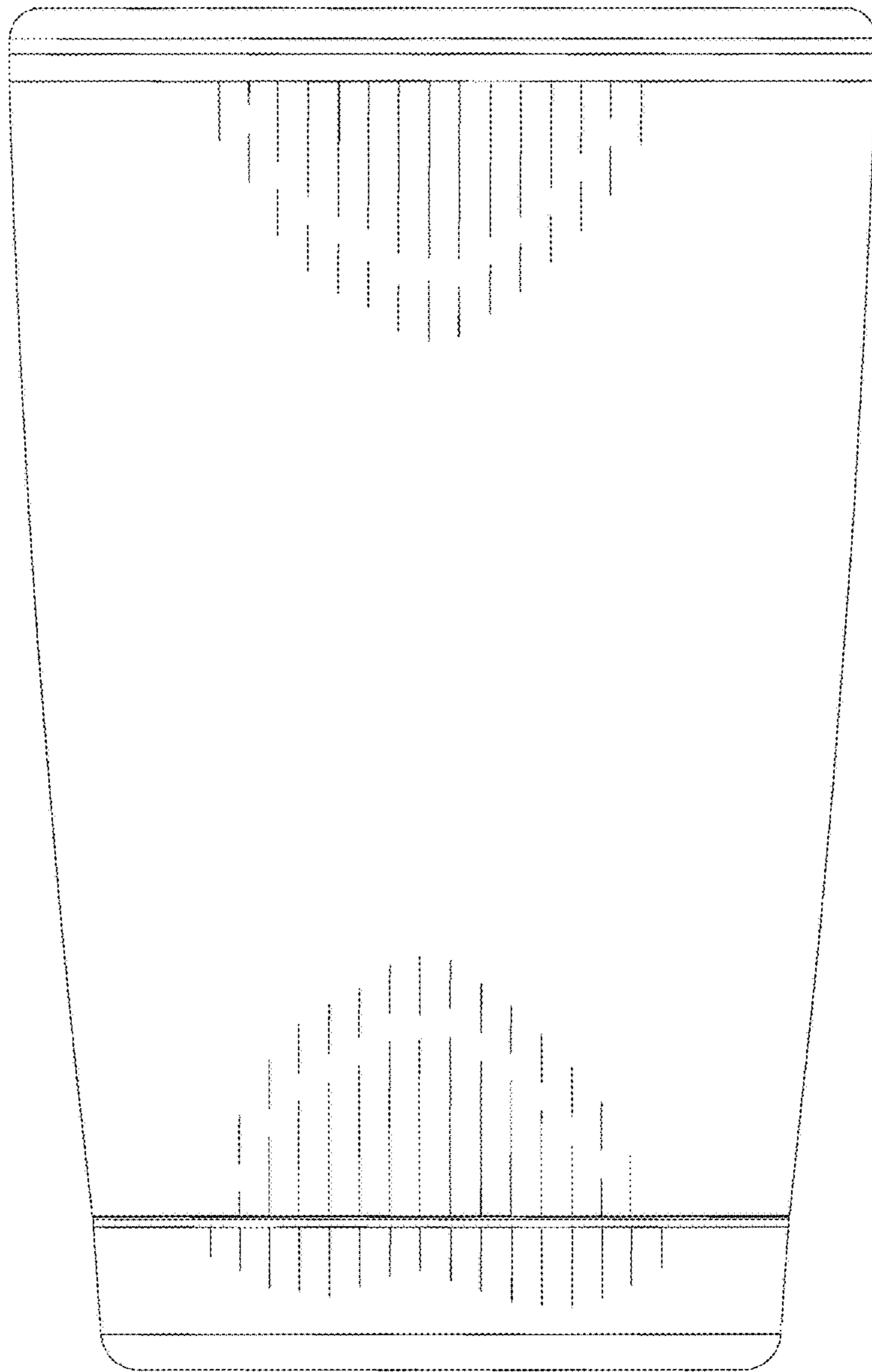

Fig. 5

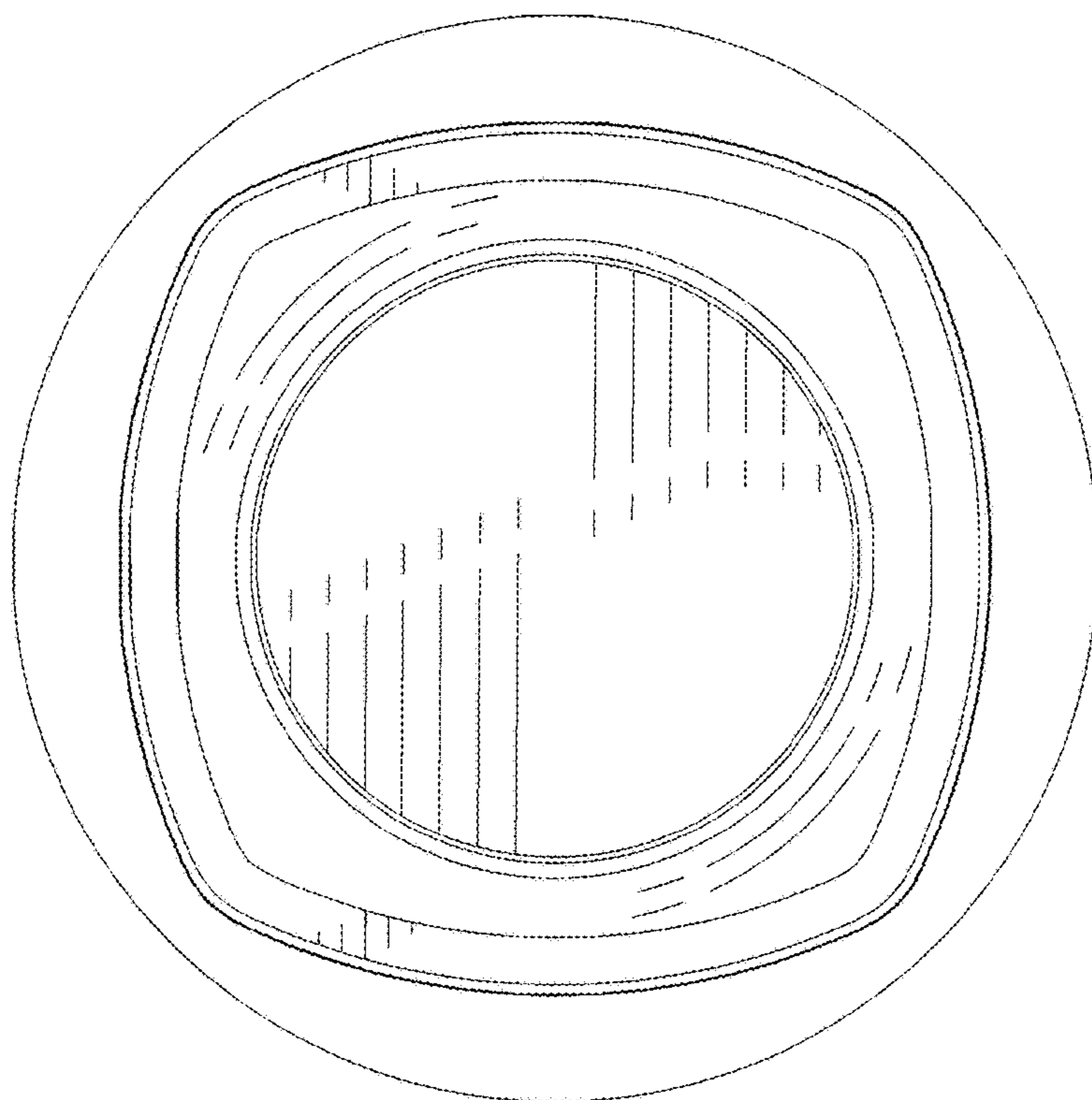

Fig. 6

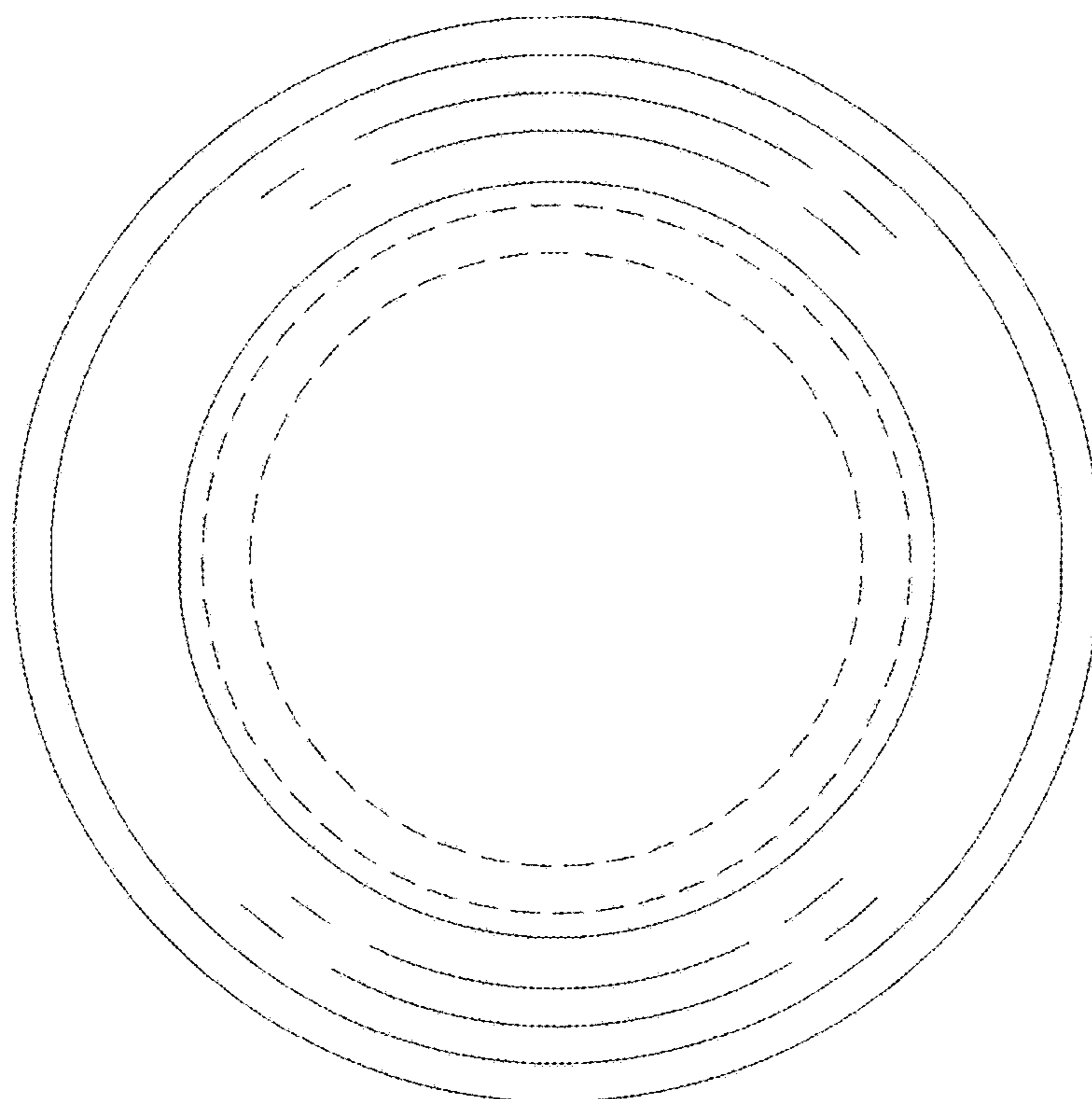

Fig. 7

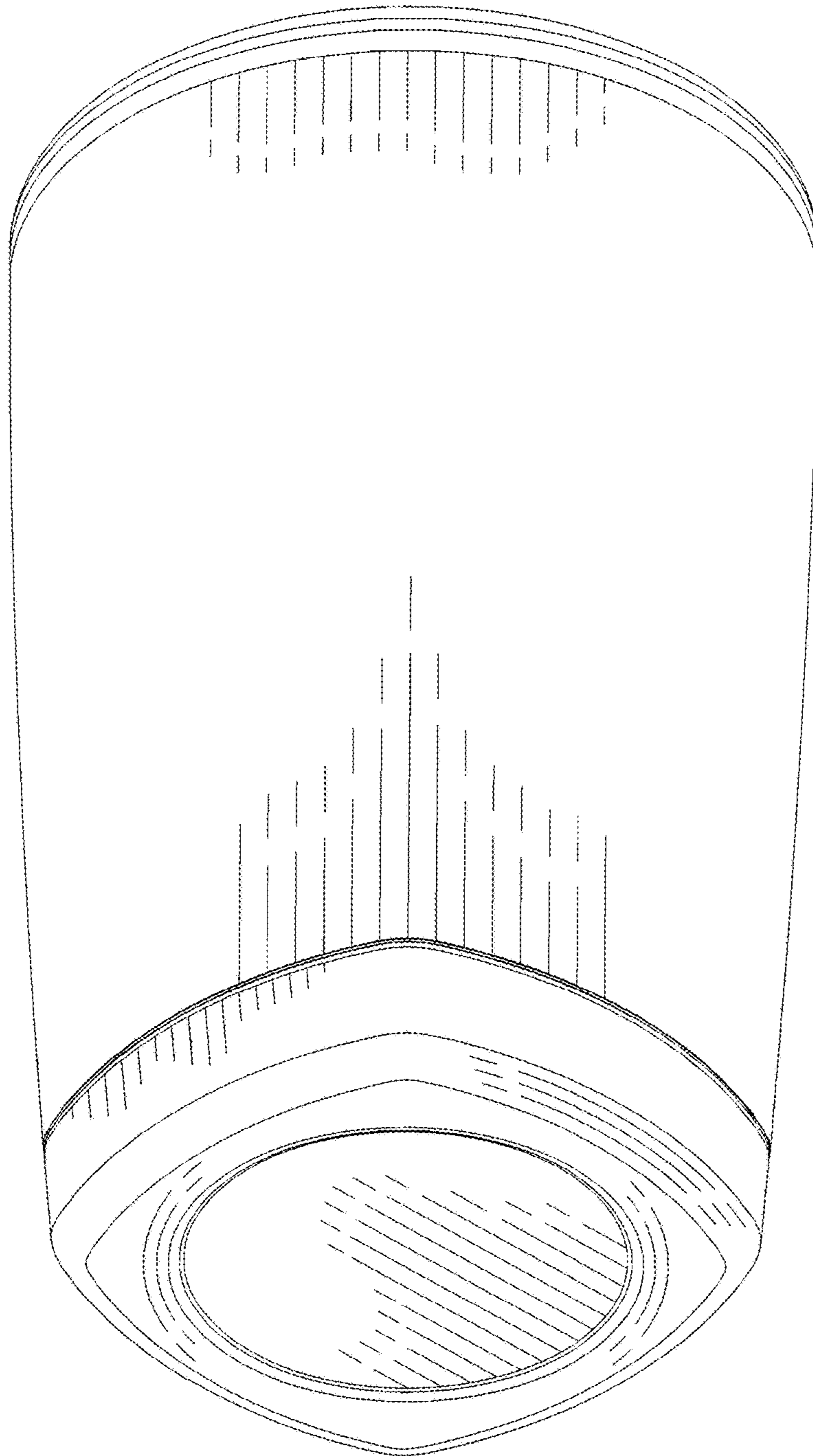

Fig. 8

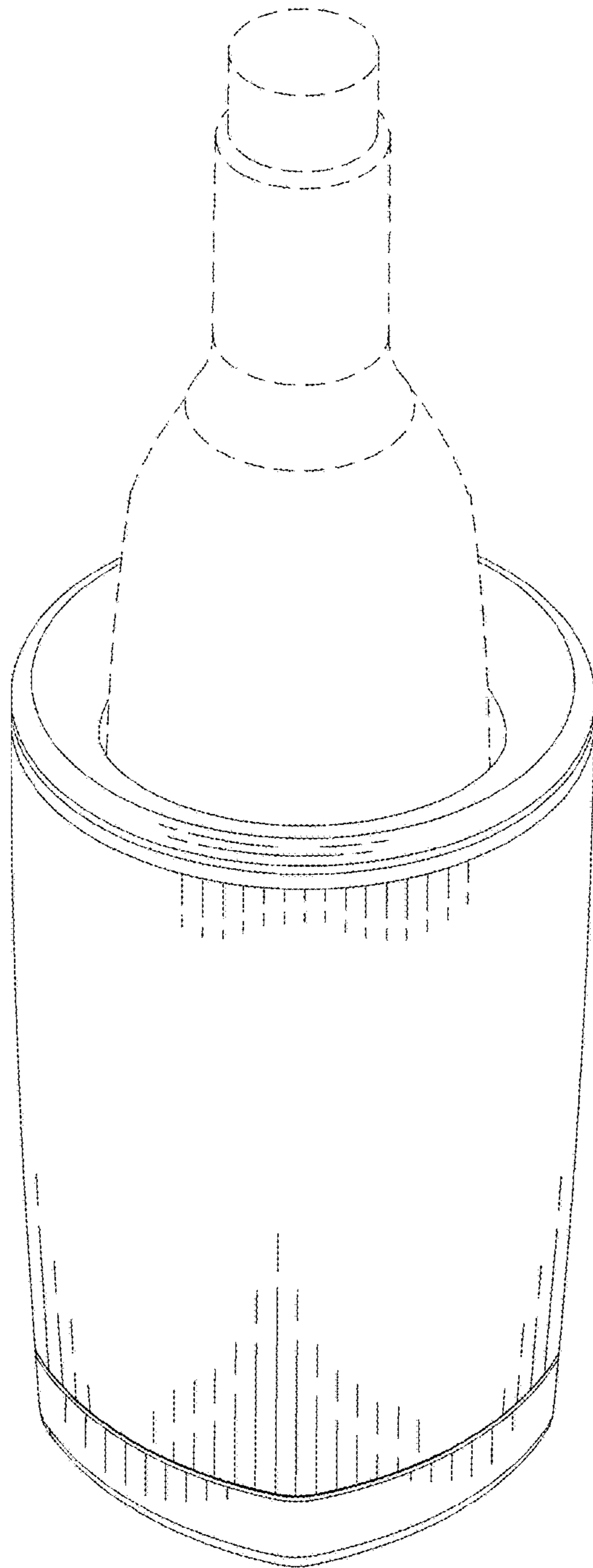

Fig. 9