



US00D843069S

(12) **United States Design Patent**  
**Villarreal**

(10) **Patent No.:** **US D843,069 S**

(45) **Date of Patent:** **\*\* Mar. 12, 2019**

(54) **SHELTER WITH GROUND COVER**

(71) Applicant: **Margarita C. Villarreal**, Floresville,  
TX (US)

(72) Inventor: **Margarita C. Villarreal**, Floresville,  
TX (US)

(\*\*) Term: **15 Years**

(21) Appl. No.: **29/554,770**

(22) Filed: **Feb. 15, 2016**

(51) **LOC (11) Cl.** ..... **30-02**

(52) **U.S. Cl.**  
USPC ..... **D30/108**

(58) **Field of Classification Search**  
USPC ..... D30/108, 109, 113, 114, 115, 117, 118,  
D30/199; D3/213–217, 273, 276, 289,  
D3/301, 242; D21/837, 834, 838, 839,  
D21/253, 254; D25/13, 16–20, 26, 56  
CPC ..... A01K 1/00; A01K 31/22; A01K 31/17;  
A01K 1/033; A01K 1/035; A01K 31/18;  
A01K 1/0245; A01K 1/0353; A01K 1/03;  
A01K 1/0254; A01K 31/08; E04H 15/40;  
E04H 15/18; E04H 15/00; E04H 15/34;  
E04B 1/32  
See application file for complete search history.

(56) **References Cited**

**U.S. PATENT DOCUMENTS**

2,170,379 A 8/1939 Ort  
2,516,869 A \* 8/1950 Harris ..... E04H 15/36  
135/115

(Continued)

**OTHER PUBLICATIONS**

Portable Folding Pet Tent, [online], [site visited Oct. 14, 2017].  
Available from Internet, URL:<https://www.aliexpress.com/item/>

Portable-Folding-Pet-Dog-Cat-Tent-Cute-Dots-Pet-Tent-Outdoor-  
Indoor-Tents-For-Kitten-Kennel/32806326651.html.\*

(Continued)

*Primary Examiner* — Caron D Neynar

*Assistant Examiner* — Katrina N Gonzalez

(74) *Attorney, Agent, or Firm* — Volk & McElroy, LLP;  
Michael D. Volk, Jr.

(57) **CLAIM**

The ornamental design for a shelter with ground cover, as  
shown and described.

**DESCRIPTION**

FIG. 1 is a perspective view of my design for a shelter with  
ground cover.

FIG. 2 is a front view of my design shown in FIG. 1.

FIG. 3 is a rear view of my design shown in FIG. 1.

FIG. 4 is a top view of my design shown in FIG. 1.

FIG. 5 is a bottom view of my design shown in FIG. 1.

FIG. 6 is a right side view of my design shown in FIG. 1, the  
left side view is a mirror image of the right side view.

FIG. 7 is perspective view of my design shown in FIG. 1  
shown in a collapsed configuration.

FIG. 8 is a top view of the configuration shown in FIG. 1.

FIG. 9 is a bottom view of the configuration shown in FIG.  
1.

FIG. 10 is a front view of the configuration shown in FIG.  
1.

FIG. 11 is a rear view of the configuration shown in FIG. 1.

FIG. 12 is a right side view of the configuration shown in  
FIG. 1; and,

FIG. 13 is a left side view of the configuration shown in FIG.  
1.

The shelter with ground cover is shown with symbolic  
breaks. The appearance of any portion of the article between  
the break lines form no part of the claimed design.

The broken lines illustrate environmental structure of the  
shelter with ground cover that form no part of the claimed  
design.

**1 Claim, 7 Drawing Sheets**

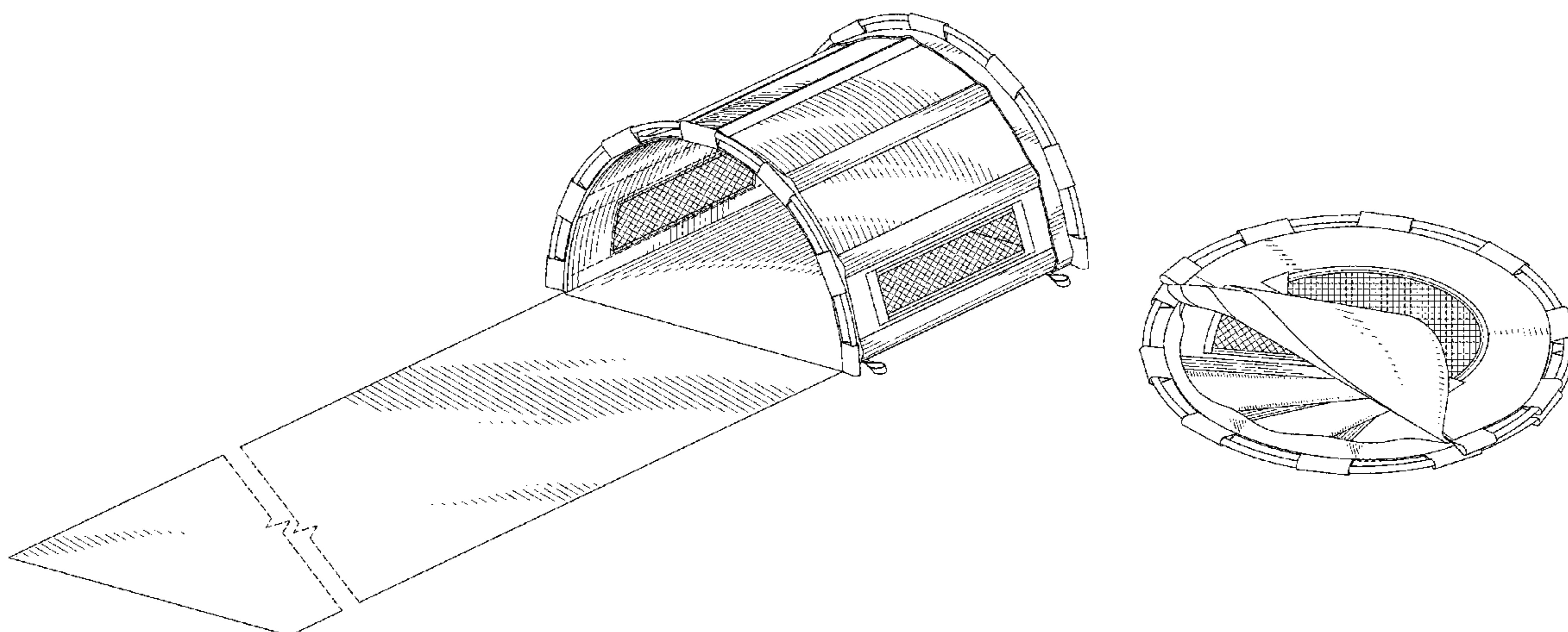

(56)

References Cited

U.S. PATENT DOCUMENTS

2,781,767	A	2/1957	Guy	
D232,850	S *	9/1974	Bloyd	D21/838
4,286,612	A	9/1981	Neal et al.	
D261,407	S *	10/1981	Moss	D21/837
D285,880	S	9/1986	Griesenbeck	
D287,041	S *	12/1986	Gitchel	D21/837
D288,613	S *	3/1987	James	D21/837
D294,752	S *	3/1988	Palier	119/28.5
D314,644	S *	2/1991	Kosharek	D30/118
D322,394	S *	12/1991	Grandesso	D30/112
D341,407	S *	11/1993	McLeese	D21/837
D373,658	S *	9/1996	Sierra	D30/108
5,823,217	A *	10/1998	Rice	E04H 15/003 135/124
D407,266	S *	3/1999	Silva	D30/108
D412,354	S *	7/1999	Takos	D21/837
D432,738	S *	10/2000	Mueller	D30/108
6,167,898	B1 *	1/2001	Larga	E04H 15/20 135/124
D441,040	S *	4/2001	Cho	D21/705
6,216,638	B1	4/2001	Pivonka et al.	
D455,238	S *	4/2002	Small	D30/108
D461,638	S	8/2002	Kellogg et al.	
D468,872	S *	1/2003	Woehler	D30/108
D484,610	S *	12/2003	Lockwood	D25/1
6,715,446	B2	4/2004	Chou	
D490,533	S *	5/2004	Lockwood	D25/1
D501,063	S *	1/2005	Bertoli	D30/108
D511,027	S *	10/2005	Mueller	D30/108
D629,973	S *	12/2010	Morton	D30/108
D661,362	S *	6/2012	Zimmer	D21/834
2005/0229866	A1	10/2005	Simpson et al.	
2007/0227571	A1	10/2007	Youn	
2010/0242856	A1	9/2010	Willard	
2012/0240970	A1 *	9/2012	Parsons	E04H 15/425 135/126
2013/0180463	A1	7/2013	Messner	
2013/0333737	A1 *	12/2013	Williams	E04H 15/18 135/97

OTHER PUBLICATIONS

Altteuri, One-Touch Portable Folding large Dog House tent for indoor,outdoor waterproof, Amazon.com, date of publication unknown (available at [http://www.amazon.com/One-Touch-Portable-Folding-outdoor-waterproof/dp/B00UH0899W/ref=sr\\_1\\_1?ie=UTF8&qid=1455201748&sr=8-1&keywords=one+touch+portable+folding](http://www.amazon.com/One-Touch-Portable-Folding-outdoor-waterproof/dp/B00UH0899W/ref=sr_1_1?ie=UTF8&qid=1455201748&sr=8-1&keywords=one+touch+portable+folding)).

Chimaera, Chimaera Foldable Pop Up Beach Tent Shelter, Amazon.com, date of publication unknown (available at [http://www.amazon.com/CHIMAERA-Foldable-Beach-Tent-Shelter/dp/B00V93B3TY/ref=sr\\_1\\_14?ie=UTF8&qid=1455202136&sr=8-14&keywords=pop-up+portable+and+foldable+tent](http://www.amazon.com/CHIMAERA-Foldable-Beach-Tent-Shelter/dp/B00V93B3TY/ref=sr_1_14?ie=UTF8&qid=1455202136&sr=8-14&keywords=pop-up+portable+and+foldable+tent)).

Ewonderworld, Portable Pet Shade Shelter Outdoor Dog Tent: Extra Large w/ Storage Pockets, Amazon.com, Date of publication unknown

(available at [http://www.amazon.com/Portable-Shade-Shelter-Outdoor-Tent/dp/B00P1ASRWM/ref=sr\\_1\\_1?ie=UTF8&qid=1455201922&sr=8-1&keywords=portable+pet+shade+shelter](http://www.amazon.com/Portable-Shade-Shelter-Outdoor-Tent/dp/B00P1ASRWM/ref=sr_1_1?ie=UTF8&qid=1455201922&sr=8-1&keywords=portable+pet+shade+shelter)).

GVGS Shop, 1Pcs Splendid Popular Pet Tent House Cat Beach Shelter Puppy Outdoor Camp Sleeping Couch Color Black, Amazon.com, date of publication unknown (available at [http://www.amazon.com/Splendid-Popular-Shelter-Outdoor-Sleeping/dp/B013KLU528/ref=sr\\_1\\_1?ie=UTF8&qid=1455202937&sr=8-1&keywords=splendid+popular+pet+tent](http://www.amazon.com/Splendid-Popular-Shelter-Outdoor-Sleeping/dp/B013KLU528/ref=sr_1_1?ie=UTF8&qid=1455202937&sr=8-1&keywords=splendid+popular+pet+tent)).

Kyjen, Outward Hound Kyjen 2546 Shade Shelter Pet Tent Outdoor Dog Shelter, Extra Large, Green, Amazon.com, date of publication unknown (available at [http://www.amazon.com/Outward-Kyjen-2546-Shelter-Outdoor/dp/B008GP8I00/ref=sr\\_1\\_1?ie=UTF8&qid=1455203046&sr=8-1&keywords=outward](http://www.amazon.com/Outward-Kyjen-2546-Shelter-Outdoor/dp/B008GP8I00/ref=sr_1_1?ie=UTF8&qid=1455203046&sr=8-1&keywords=outward)).

Lucy's Beach House, Pop Up Portable Pet Tent—Large (31"×31"×31"), Amazon.com, date of publication unknown (available at [http://www.amazon.com/POP-UP-PORTABLE-PET-TENT/dp/B007V5ANH2/ref=sr\\_1\\_2?ie=UTF8&qid=1455202649&sr=8-2&keywords=pop+up+portable+pet+tent](http://www.amazon.com/POP-UP-PORTABLE-PET-TENT/dp/B007V5ANH2/ref=sr_1_2?ie=UTF8&qid=1455202649&sr=8-2&keywords=pop+up+portable+pet+tent)).

MPET, Large Blue Portable Pet Soft Crate/Carrier for Travel, Indoor/Outdoor \*28"L×21"W×21"H, Amazon.com, date of publication unknown (available at [http://www.amazon.com/Portable-Carrier-Travel-Indoor-Outdoor/dp/B002N7RT7A/ref=sr\\_1\\_4?ie=UTF8&qid=1455202425&sr=8-4&keywords=large+blue+portable+soft+sided](http://www.amazon.com/Portable-Carrier-Travel-Indoor-Outdoor/dp/B002N7RT7A/ref=sr_1_4?ie=UTF8&qid=1455202425&sr=8-4&keywords=large+blue+portable+soft+sided)).

MTN Gearsmith, New Large Dog Pet Puppy Portable Foldable Soft Crate Playpen Kennel House—Blue Red Green, Amazon.com, date of publication unknown (available at [http://www.amazon.com/Portable-Foldable-Playpen-Kennel--Green/dp/B00EKW3W8Q/ref=sr\\_1\\_9?ie=UTF8&qid=1455202189&sr=8-9&keywords=portable+playpen+kennel+foldable](http://www.amazon.com/Portable-Foldable-Playpen-Kennel--Green/dp/B00EKW3W8Q/ref=sr_1_9?ie=UTF8&qid=1455202189&sr=8-9&keywords=portable+playpen+kennel+foldable)).

Sport Pet Designs, Pop Open Dog Kennel for Pets up to 25 Lbs. 15"W×15"H×26"D Assorted Colors, Amazon.com, date of publication unknown (available at [http://www.amazon.com/Sport-Pet-Designs-Kennel-Small/dp/B0072NPTGI/ref=sr\\_1\\_3?ie=UTF8&qid=1455203276&sr=8-3&keywords=pop+open+dog+kenneltward+hound+pet+tent](http://www.amazon.com/Sport-Pet-Designs-Kennel-Small/dp/B0072NPTGI/ref=sr_1_3?ie=UTF8&qid=1455203276&sr=8-3&keywords=pop+open+dog+kenneltward+hound+pet+tent)).

Uxcell, Uxcell Paw Pattern Pet Tent Doghouse Nest, 40cm, Red, Amazon.com, date of publication unknown (available at [http://www.amazon.com/Uxcell-Pattern-Tent-Doghouse-Nest/dp/B00ZRHO44O/ref=sr\\_1\\_3?ie=UTF8&qid=1455202763&sr=8-3&keywords=uxcell+p](http://www.amazon.com/Uxcell-Pattern-Tent-Doghouse-Nest/dp/B00ZRHO44O/ref=sr_1_3?ie=UTF8&qid=1455202763&sr=8-3&keywords=uxcell+p)).

Vedem, Vedem Pets Portable Sun Shelter Tent House, Amazon.com, date of publication unknown (available at [http://www.amazon.com/Vedem-Pets-Portable-Shelter-House/dp/B00JTTM4IE/ref=sr\\_1\\_1?ie=UTF8&qid=1455202299&sr=8-1&keywords=vedem+tent+house](http://www.amazon.com/Vedem-Pets-Portable-Shelter-House/dp/B00JTTM4IE/ref=sr_1_1?ie=UTF8&qid=1455202299&sr=8-1&keywords=vedem+tent+house)).

Ware, Ware Manufacturing Twist-N-Go Kennel Dog Carrier, Amazon.com, date of publication unknown (available at [http://www.amazon.com/Ware-Manufacturing-Twist-N-Go-Kennel-Large/dp/B001VJIE8Q/ref=sr\\_1\\_2?ie=UTF8&qid=1455202546&sr=8-2&keywords=twist-n-go](http://www.amazon.com/Ware-Manufacturing-Twist-N-Go-Kennel-Large/dp/B001VJIE8Q/ref=sr_1_2?ie=UTF8&qid=1455202546&sr=8-2&keywords=twist-n-go)).

\* cited by examiner

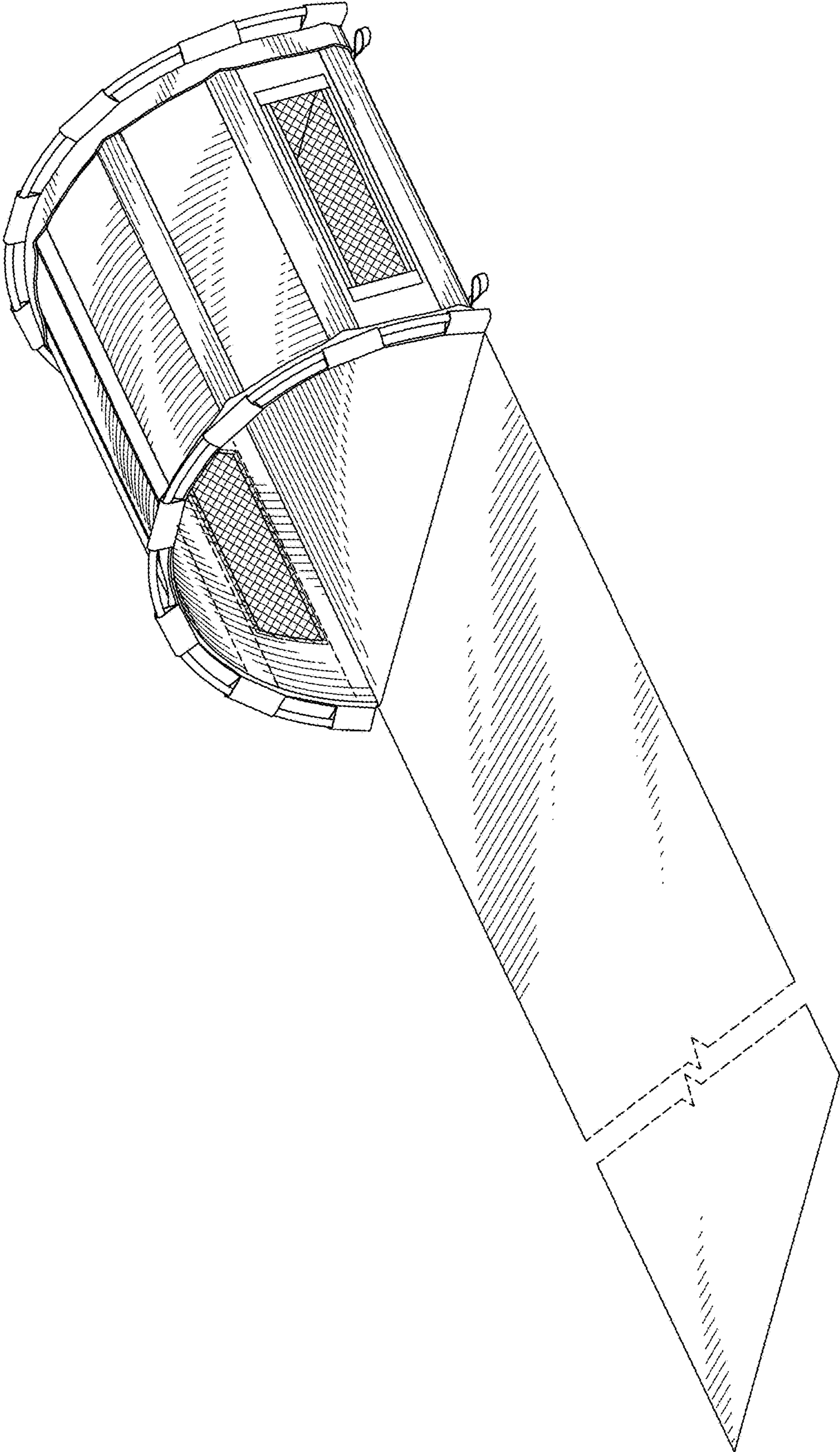

FIG. 1

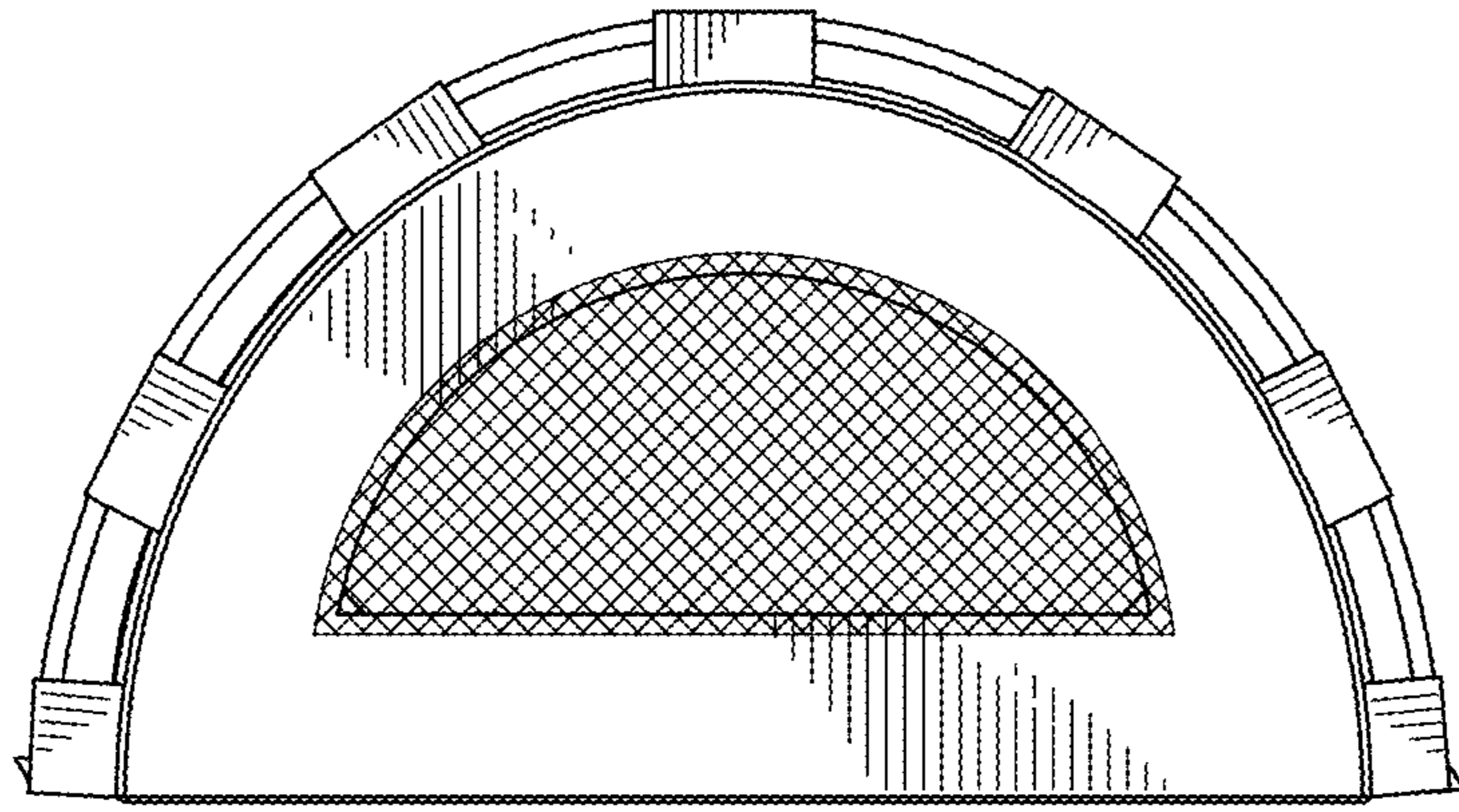

FIG. 2

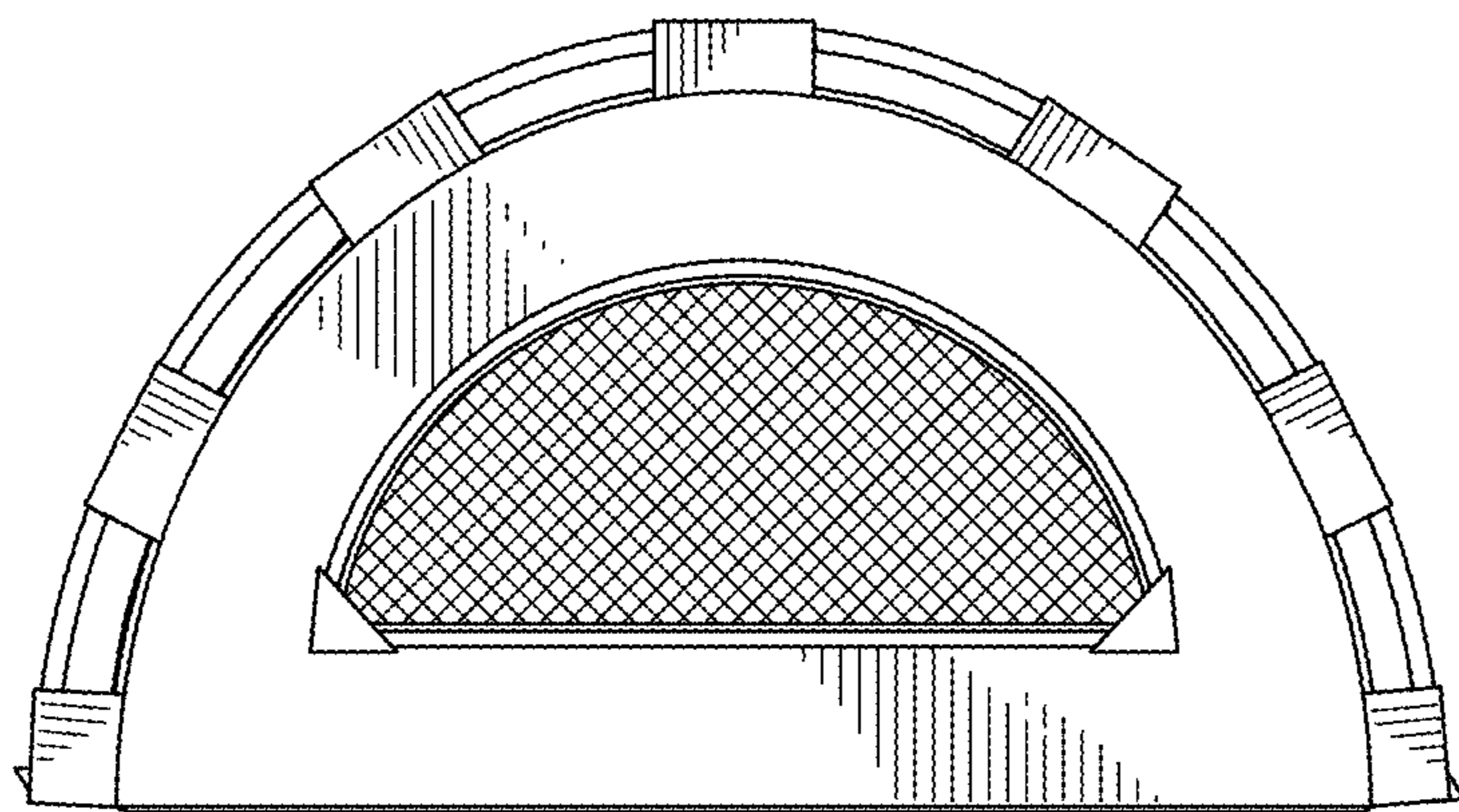

FIG. 3

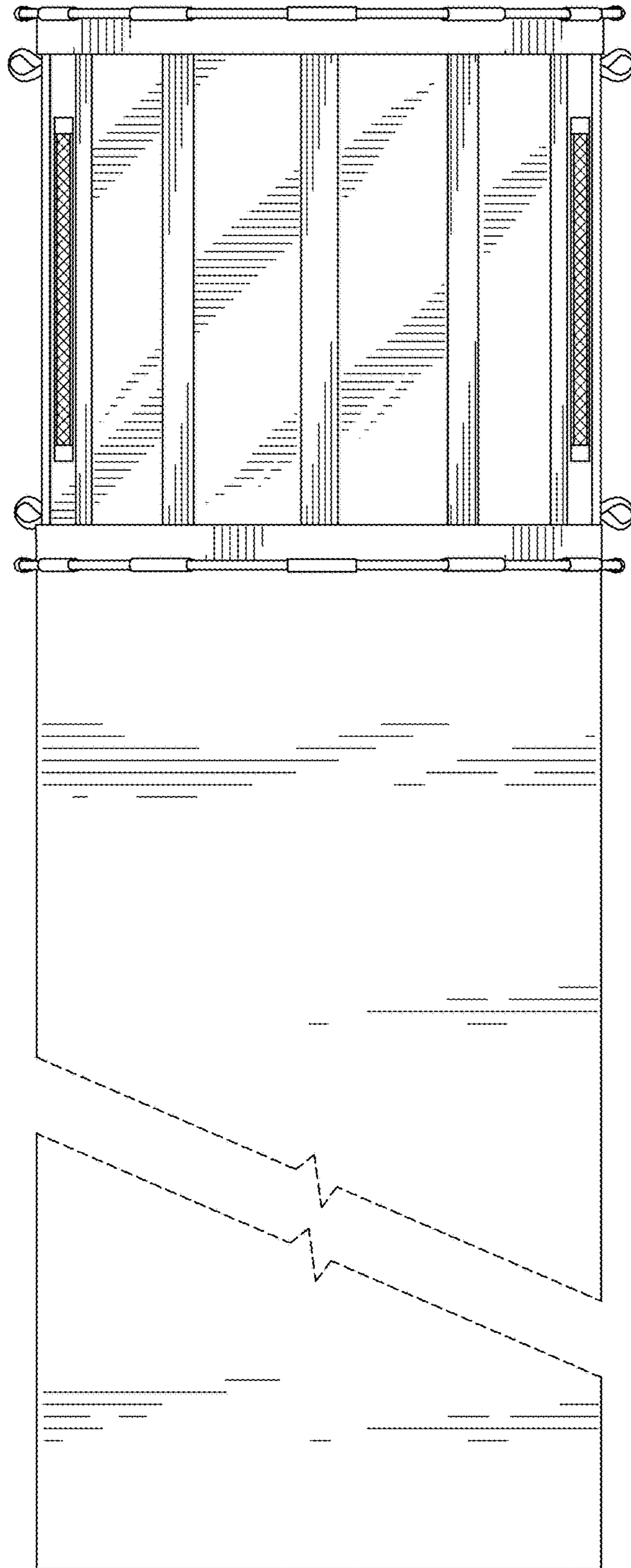

FIG. 4

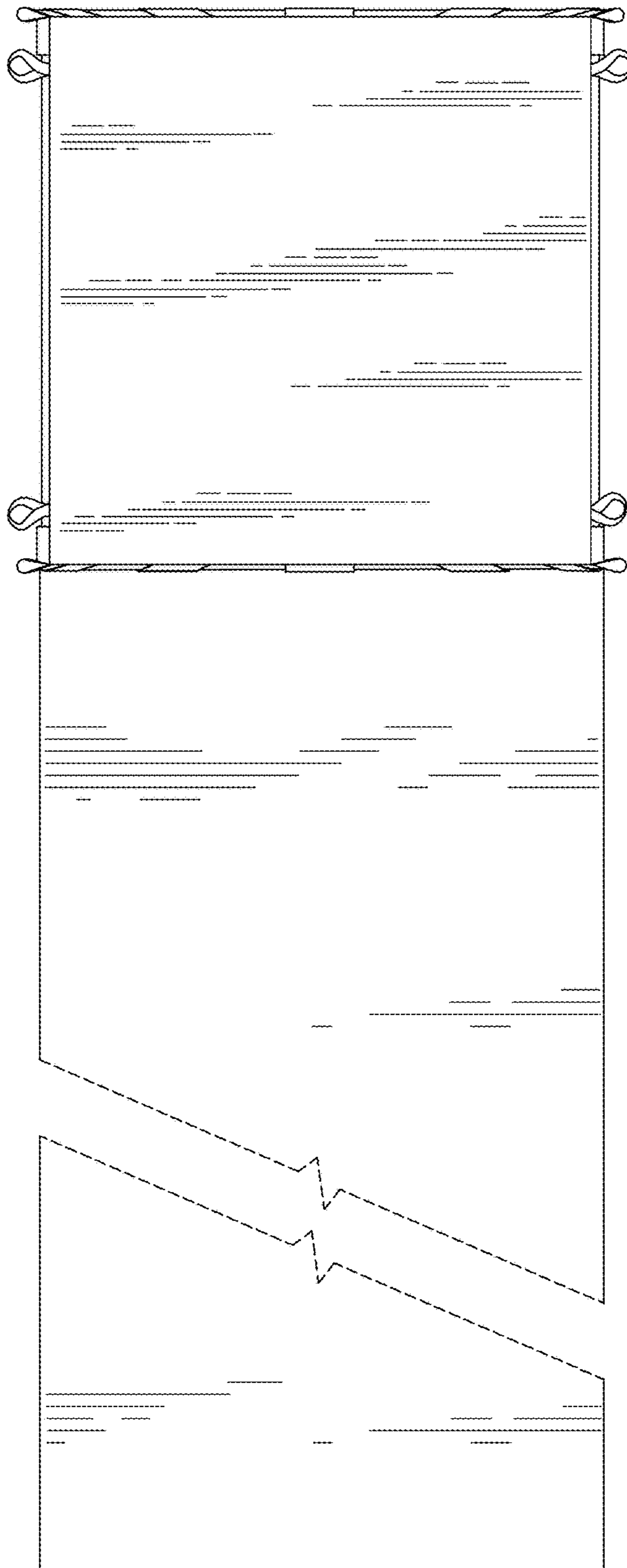

FIG. 5

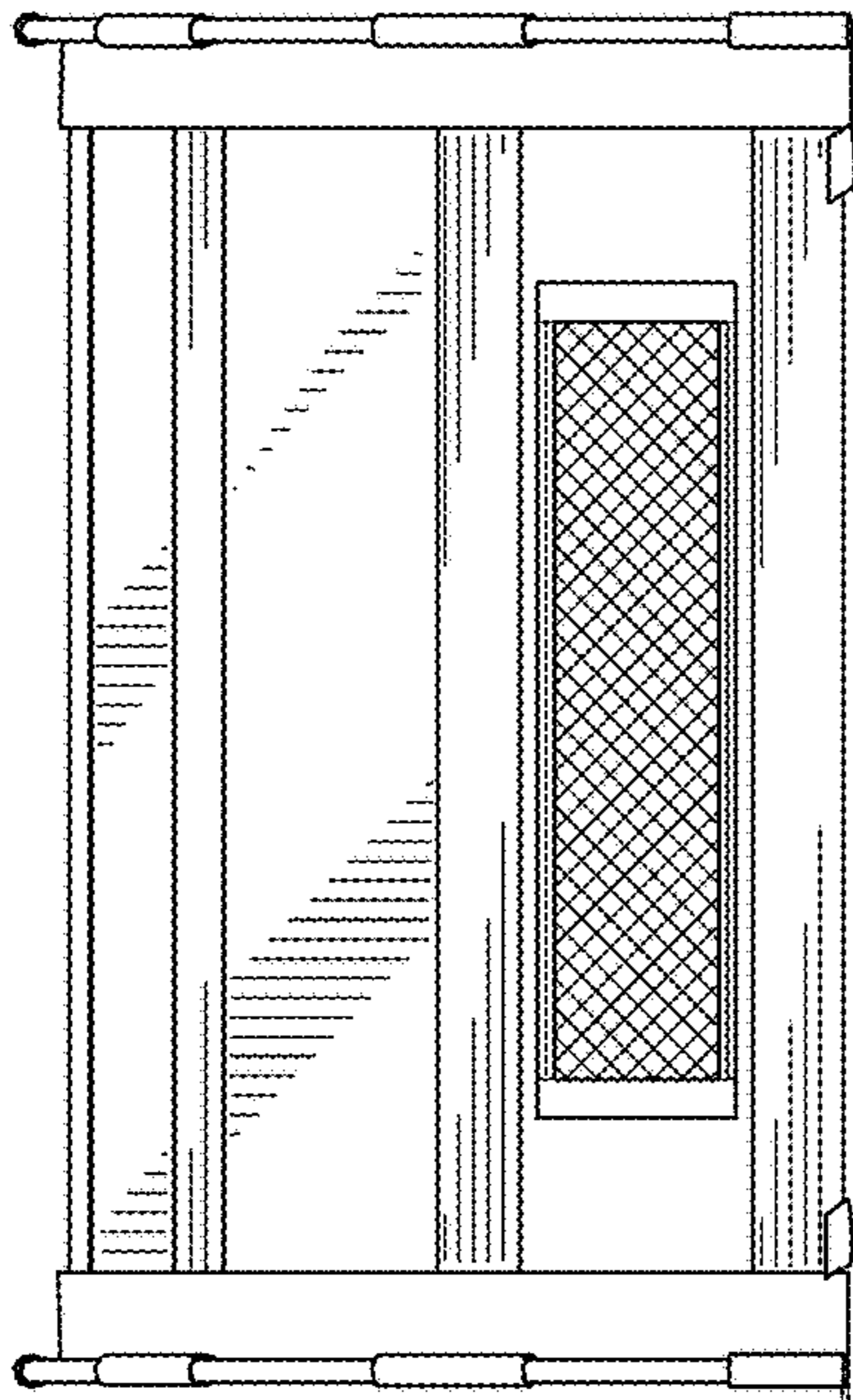

FIG. 6

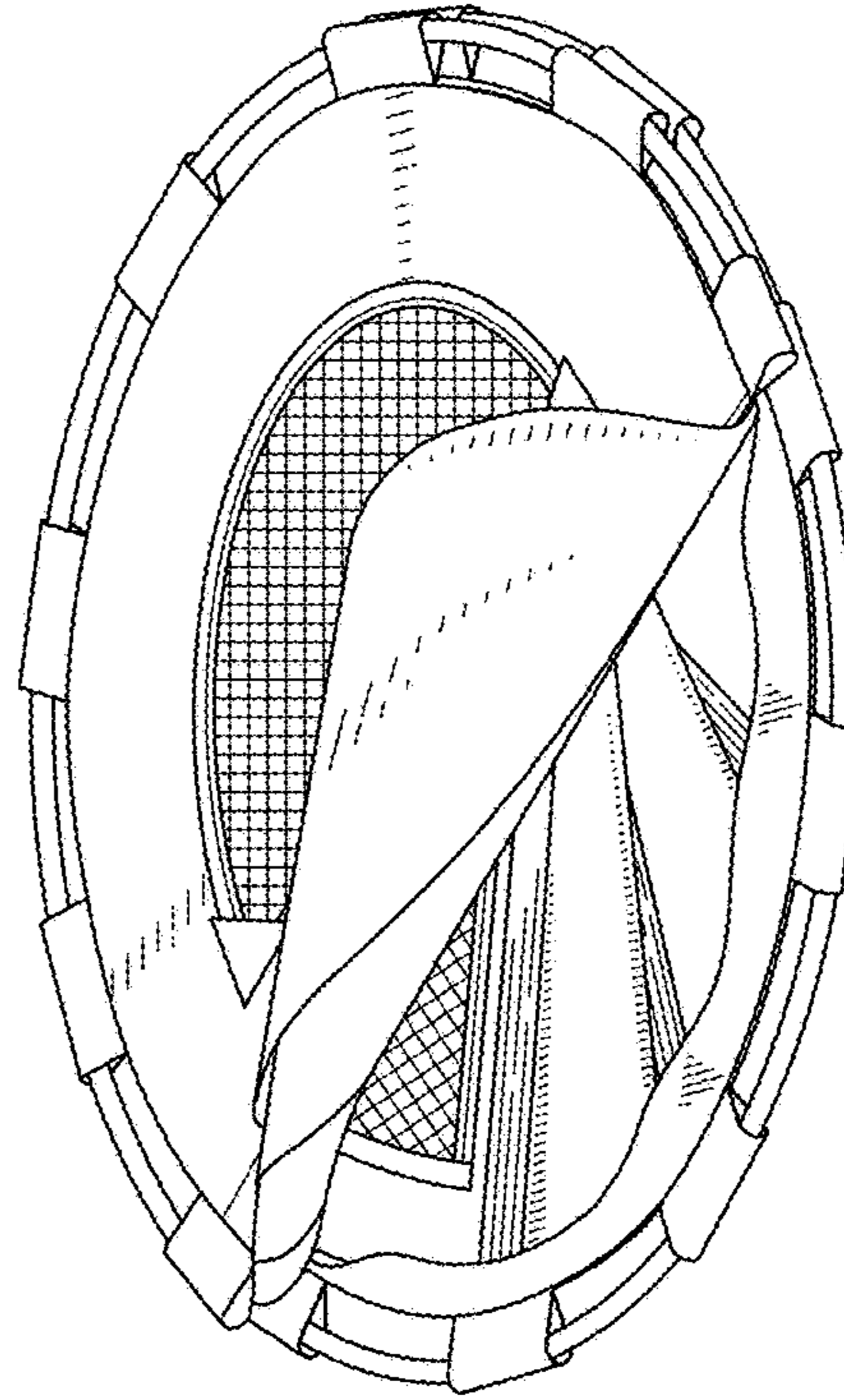

FIG. 7

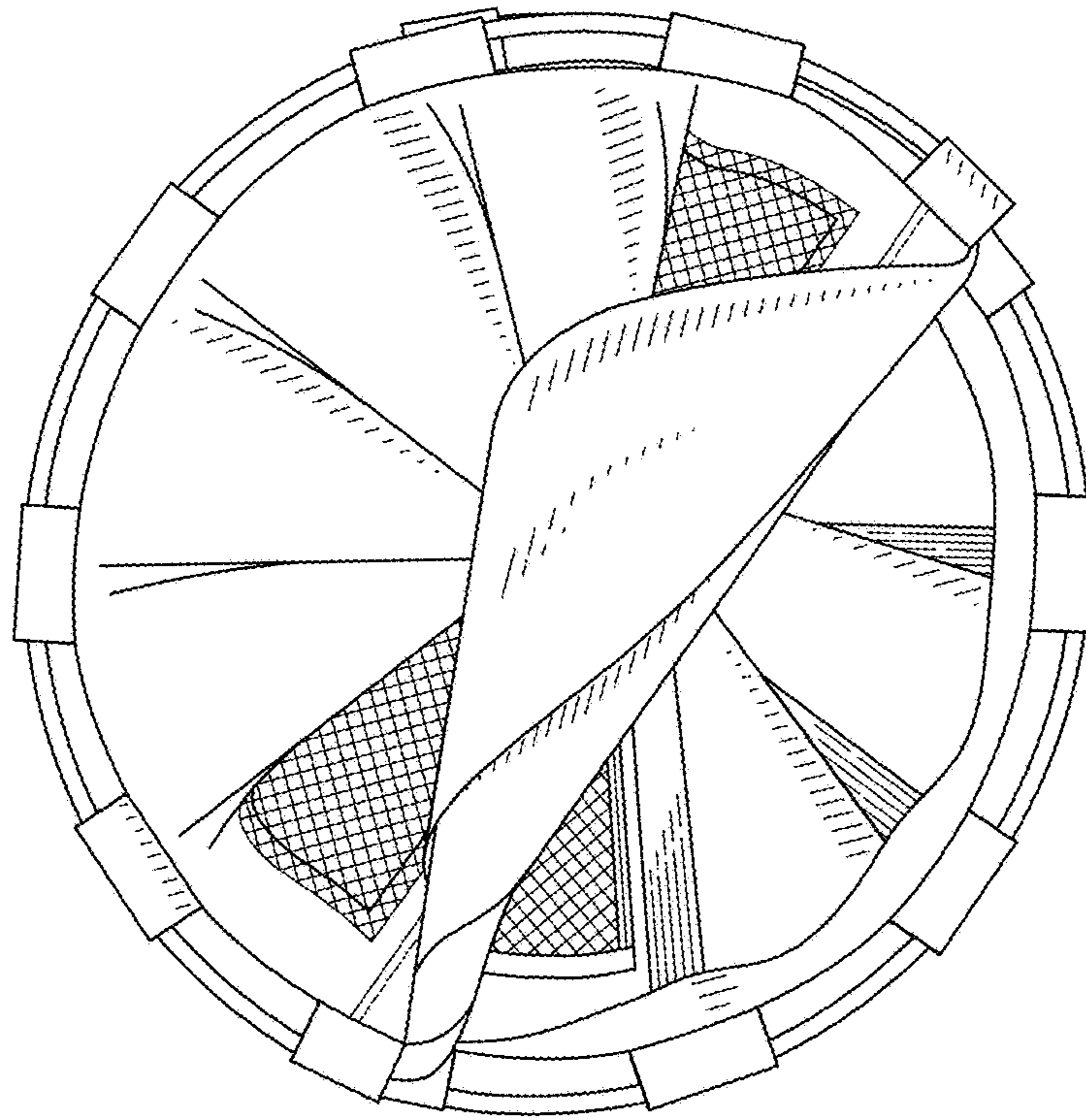

FIG. 9

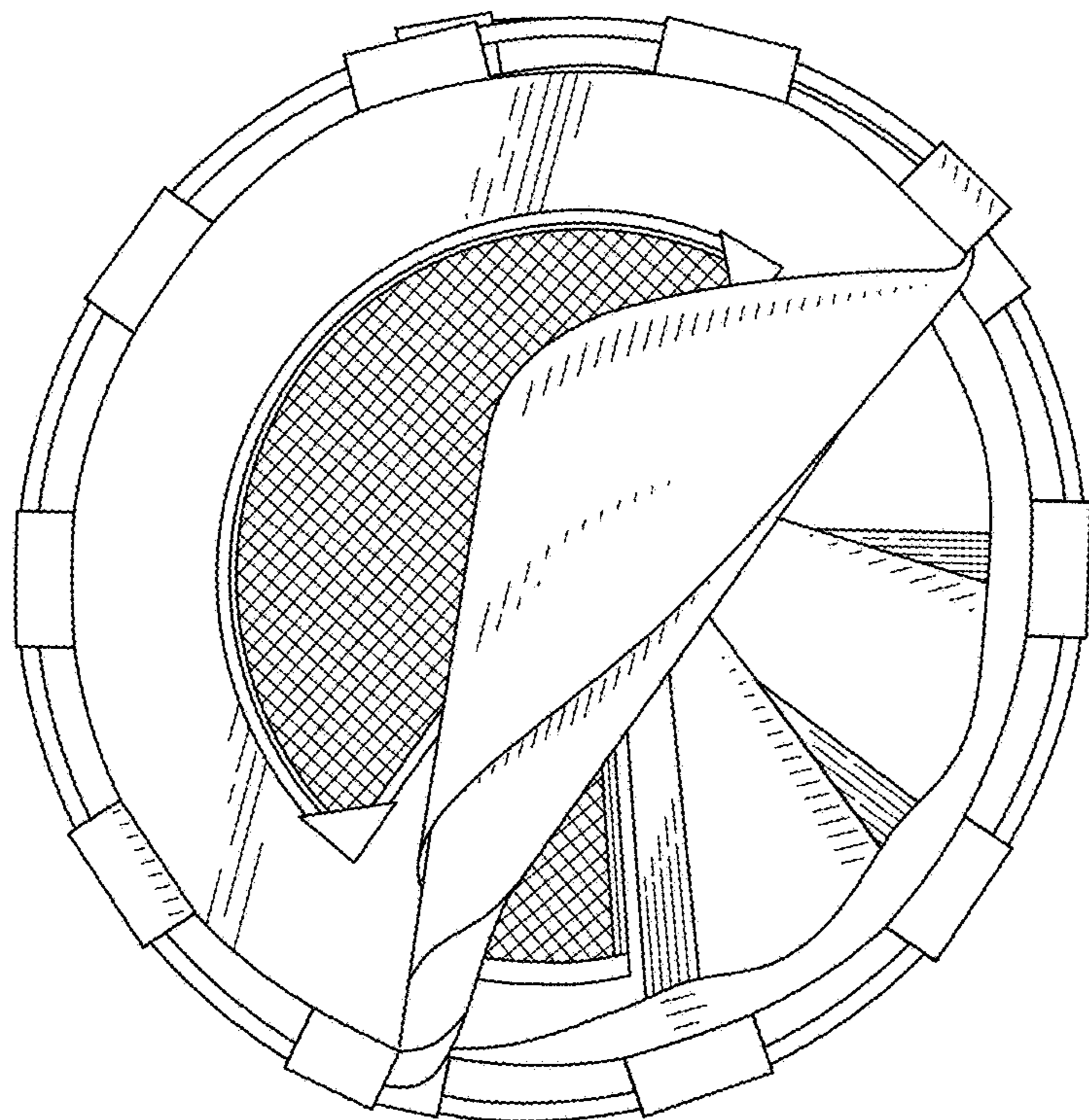

FIG. 8



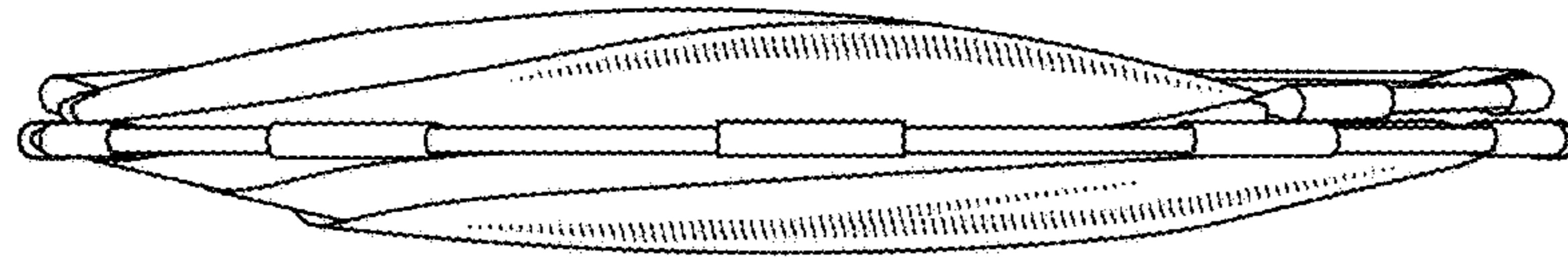

FIG. 10

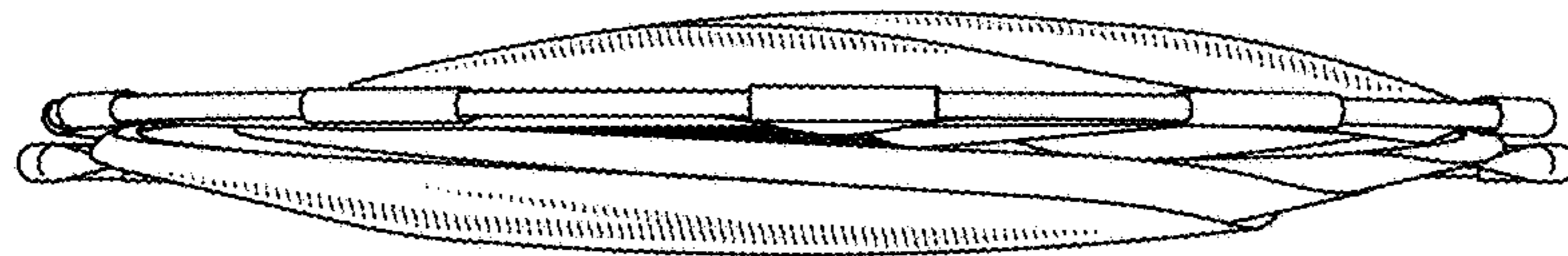

FIG. 11

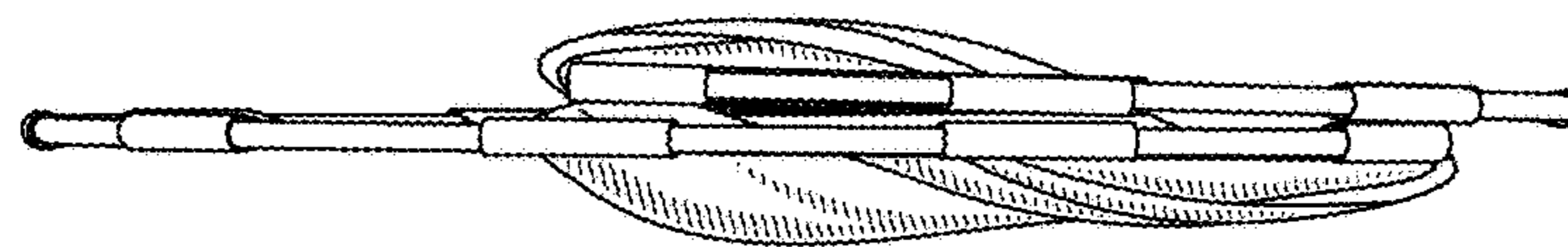

FIG. 12

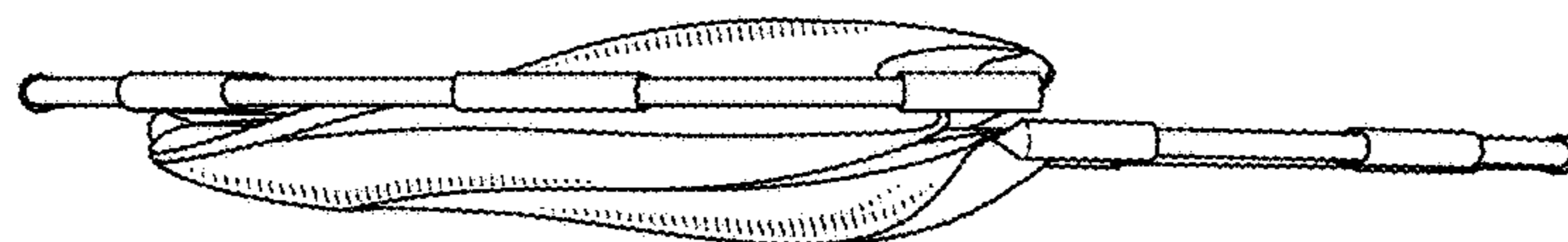

FIG. 13