

US00D843030S

(12) **United States Design Patent**  
**Lee et al.**

(10) **Patent No.:** **US D843,030 S**  
(45) **Date of Patent:** **\*\* Mar. 12, 2019**

(54) **VEHICLE LAMP**  
(71) Applicant: **GM GLOBAL TECHNOLOGY OPERATIONS LLC**, Detroit, MI (US)  
(72) Inventors: **Eunhwa Lee**, Seoul (KR); **Daeil Lim**, Seoul (KR); **Jinyoong Cha**, Bucheon-si (KR)  
(73) Assignee: **GM Global Technology Operations LLC**, Detroit, MI (US)  
(\*\*) Term: **15 Years**  
(21) Appl. No.: **29/635,518**  
(22) Filed: **Jan. 31, 2018**  
(30) **Foreign Application Priority Data**

D592,105 S 5/2009 Dean et al.  
D597,447 S 8/2009 Folden  
D600,595 S 9/2009 Nakamura et al.  
D601,925 S 10/2009 O'Donnell  
D603,755 S 11/2009 Peters  
D604,203 S 11/2009 O'Donnell  
D605,082 S 12/2009 Munson  
D605,083 S 12/2009 Manoogian, II et al.  
D605,977 S 12/2009 Zipfel et al.  
D605,978 S 12/2009 Wolff et al.  
D608,249 S 1/2010 Peters  
D608,690 S 1/2010 Folden et al.  
D608,691 S 1/2010 Zak, Jr. et al.  
D609,608 S 2/2010 Boniface et al.  
D611,387 S 3/2010 Thompson et al.  
D611,879 S 3/2010 Kim et al.  
D612,297 S 3/2010 Peters et al.  
D613,645 S 4/2010 Song et al.  
D615,458 S 5/2010 Thompson et al.  
D618,595 S 6/2010 Ware et al.  
D623,090 S 9/2010 Cox et al.  
D627,262 S 11/2010 Ikeda et al.  
D635,488 S 4/2011 Phipps

(Continued)

Oct. 20, 2017 (KR) ..... 30-2017-0048983

(51) **LOC (11) Cl.** ..... **26-06**  
(52) **U.S. Cl.**  
USPC ..... **D26/28**  
(58) **Field of Classification Search**  
USPC ..... D26/28-36  
CPC ..... B60Q 9/13; B60Q 9/135; B60Q 9/1375;  
F21S 48/00; F21S 48/10; F21S 48/115;  
F21S 48/225; F21S 48/1233; F21S  
48/1266; F21S 48/1388; F21S 48/2268;  
F21V 21/04  
See application file for complete search history.

*Primary Examiner* — Marcus A Jackson

(74) *Attorney, Agent, or Firm* — Reising Ethington, P.C.

(57) **CLAIM**

The ornamental design for a vehicle lamp, as shown and described.

**DESCRIPTION**

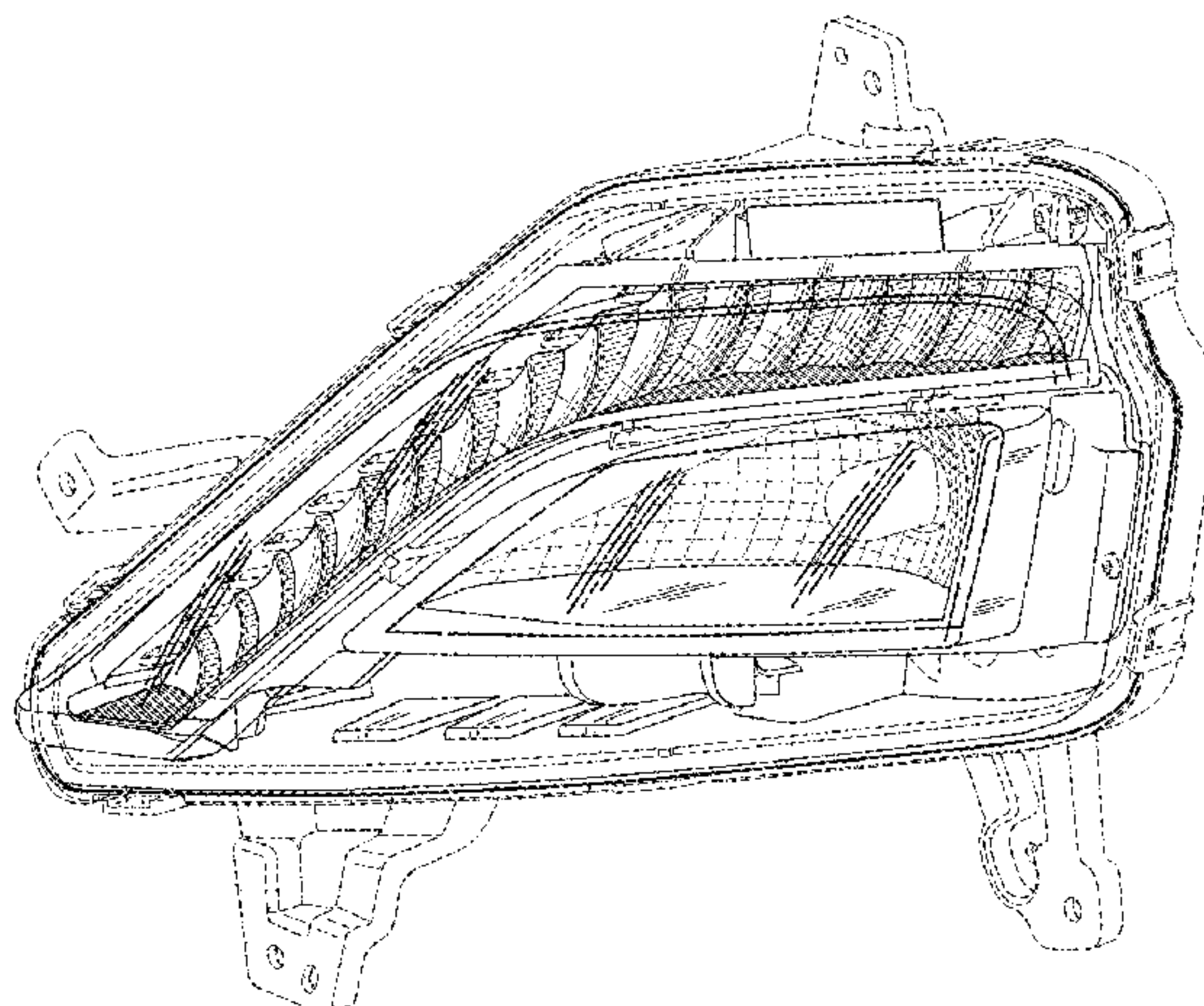
FIG. 1 is a perspective view of the vehicle lamp;  
FIG. 2 is a front elevation view thereof;  
FIG. 3 is a rear elevation view thereof;  
FIG. 4 is a left side view thereof;  
FIG. 5 is a right side view thereof;  
FIG. 6 is a top plan view thereof; and,  
FIG. 7 is a bottom plan view thereof.

The broken lines in the drawings illustrate portions of the vehicle lamp that form no part of the claimed design.

(56) **References Cited**  
U.S. PATENT DOCUMENTS

D524,466 S \* 7/2006 Essig ..... D26/28  
D538,954 S \* 3/2007 Pfeiffer ..... D26/28  
D552,768 S \* 10/2007 Leclercq ..... D26/28  
D570,007 S \* 5/2008 Hsu ..... D26/28  
D570,742 S 6/2008 Takagi et al.

**1 Claim, 7 Drawing Sheets**



(56)

## References Cited

## U.S. PATENT DOCUMENTS

D644,147 S	8/2011	Suh et al.	D749,250 S	2/2016	Thole et al.
D644,567 S	9/2011	Kozub	D749,985 S	2/2016	Kozub et al.
D657,718 S	4/2012	Zipfel et al.	D749,997 S	2/2016	McMahan et al.
D659,052 S	5/2012	Ware et al.	D750,001 S	2/2016	Thole et al.
D659,053 S	5/2012	Ware et al.	D753,032 S	4/2016	Smith et al.
D668,182 S	10/2012	Barba Franco et al.	D753,033 S	4/2016	Thole et al.
D668,183 S	10/2012	Smart	D753,034 S	4/2016	Thole et al.
D678,820 S	3/2013	Son et al.	D753,035 S	4/2016	Boniface et al.
D678,821 S	3/2013	Ikeda et al.	D753,559 S	4/2016	McMahan et al.
D680,909 S	4/2013	Munson et al.	D753,560 S	4/2016	McMahan et al.
D680,910 S	4/2013	David	D753,567 S	4/2016	Boniface et al.
D684,899 S	6/2013	Baker	D754,571 S	4/2016	Boniface et al.
D686,536 S	7/2013	McCabe et al.	D754,572 S	4/2016	McMahan et al.
D692,798 S	11/2013	Thurber	D755,088 S	5/2016	McMahan et al.
D692,799 S	11/2013	Smith et al.	D756,869 S	5/2016	McMahan et al.
D696,157 S	12/2013	Loeb	D758,271 S	6/2016	McMahan et al.
D699,629 S	2/2014	Ikeda et al.	D764,975 S	8/2016	Aengenheyster
D700,871 S	3/2014	O'Donnell et al.	D764,976 S	8/2016	Aengenheyster
D703,103 S	4/2014	Lee	D767,449 S	9/2016	Pevovar et al.
D704,103 S	5/2014	Mack et al.	D767,450 S	9/2016	Lee et al.
D705,132 S	5/2014	Ware et al.	D767,451 S	9/2016	Kozub et al.
D705,699 S	5/2014	Ware et al.	D767,454 S	9/2016	McMahan et al.
D713,298 S	9/2014	Dyson	D767,458 S	9/2016	Kim
D713,764 S	9/2014	Ferlazzo et al.	D767,459 S	9/2016	Kim
D716,696 S	11/2014	Thole et al.	D767,460 S	9/2016	Kozub et al.
D716,706 S	11/2014	Thole et al.	D767,461 S	9/2016	Kozub et al.
D716,709 S	11/2014	Thole et al.	D771,528 S	11/2016	Smith et al.
D717,696 S	11/2014	Thole et al.	D771,529 S	11/2016	Thole et al.
D718,189 S	11/2014	Krieg et al.	D771,532 S	11/2016	Kapitonov
D718,683 S	12/2014	Thole et al.	D771,533 S	11/2016	Kapitonov
D722,282 S	2/2015	Loeb	D772,766 S	11/2016	Kozub et al.
D722,533 S	2/2015	Thole et al.	D772,767 S	11/2016	Kim
D722,534 S	2/2015	Munson et al.	D773,084 S	11/2016	Kapitonov
D724,510 S	3/2015	McMahan et al.	D773,086 S	11/2016	McCabe et al.
D725,001 S	3/2015	McMahan et al.	D774,226 S	12/2016	McCabe et al.
D726,591 S	4/2015	Jacob	D775,003 S	12/2016	Pevovar et al.
D730,776 S	6/2015	Smart	D775,007 S	12/2016	Thole et al.
D730,783 S	6/2015	Henriques et al.	D775,010 S	12/2016	Kim et al.
D732,427 S	6/2015	Loeb	D775,049 S	12/2016	Scheer et al.
D732,429 S	6/2015	Loeb	D775,549 S	1/2017	Karras
D732,430 S	6/2015	Loeb	D775,554 S	1/2017	Kapitonov
D732,431 S	6/2015	Loeb	D776,020 S	1/2017	Kapitonov
D732,432 S	6/2015	Aengenheyster	D776,581 S	1/2017	Pevovar et al.
D732,433 S	6/2015	Aengenheyster	D776,583 S	1/2017	Scheer et al.
D732,435 S	6/2015	Mackay	D776,841 S	1/2017	Kozub et al.
D733,002 S	6/2015	Loeb	D776,843 S	1/2017	McCabe et al.
D735,611 S	8/2015	Aengenheyster	D776,846 S	1/2017	Willett et al.
D735,627 S	8/2015	Smith	D777,359 S	1/2017	Kozub et al.
D736,451 S	8/2015	Smith	D777,360 S	1/2017	Kozub et al.
D739,306 S	9/2015	McMahan et al.	D777,361 S	1/2017	Kozub et al.
D739,317 S	9/2015	McMahan et al.	D777,604 S	1/2017	McNerney
D741,223 S	10/2015	Kim et al.	D777,605 S	1/2017	Ferlazzo et al.
D743,309 S	11/2015	Thole et al.	D777,620 S	1/2017	Pevovar et al.
D743,313 S	11/2015	Smith et al.	D777,621 S	1/2017	Kim
D743,314 S	11/2015	Thole et al.	D777,622 S	1/2017	Kozub et al.
D743,857 S	11/2015	McMahan et al.	D777,628 S	1/2017	Kozub et al.
D744,158 S	11/2015	Willett et al.	D777,955 S	1/2017	Willett et al.
D745,086 S	12/2015	Finos et al.	D778,212 S	2/2017	Kozub et al.
D745,719 S	12/2015	Boniface et al.	D778,215 S	2/2017	Kozub et al.
D745,725 S	12/2015	McMahan et al.	D780,064 S	2/2017	Smith et al.
D745,726 S	12/2015	McMahan et al.	D780,067 S	2/2017	Zipfel et al.
D745,837 S	12/2015	Smith et al.	D780,068 S	2/2017	Whitla et al.
D746,726 S	1/2016	Smith et al.	D780,077 S	2/2017	Kim et al.
D746,727 S	1/2016	Smith et al.	D780,081 S	2/2017	Lee
D746,728 S	1/2016	Smith et al.	D780,084 S	2/2017	Scheer et al.
D746,729 S	1/2016	Boniface et al.	D780,631 S	3/2017	Kozub et al.
D746,730 S	1/2016	Kim et al.	D780,644 S	3/2017	Kim et al.
D747,514 S	1/2016	McMahan et al.	D781,184 S	3/2017	Thole et al.
D747,515 S	1/2016	McMahan et al.	D781,192 S	3/2017	Kozub et al.
D747,819 S	1/2016	Thole et al.	D782,379 S	3/2017	Wassell
D749,021 S	2/2016	Boniface et al.	D783,482 S	4/2017	Smith et al.
D749,026 S	2/2016	Smith et al.	D784,213 S	4/2017	Karras
D749,027 S	2/2016	McMahan et al.	D784,223 S	4/2017	Lee
D749,246 S	2/2016	Thole et al.	D784,226 S	4/2017	Cheng
D749,249 S	2/2016	Thole et al.	D784,579 S	4/2017	Cheng et al.
			D784,877 S	4/2017	Lee
			D784,886 S	4/2017	Smith et al.
			D785,521 S	5/2017	Smith et al.
			D786,149 S	5/2017	Pevovar et al.



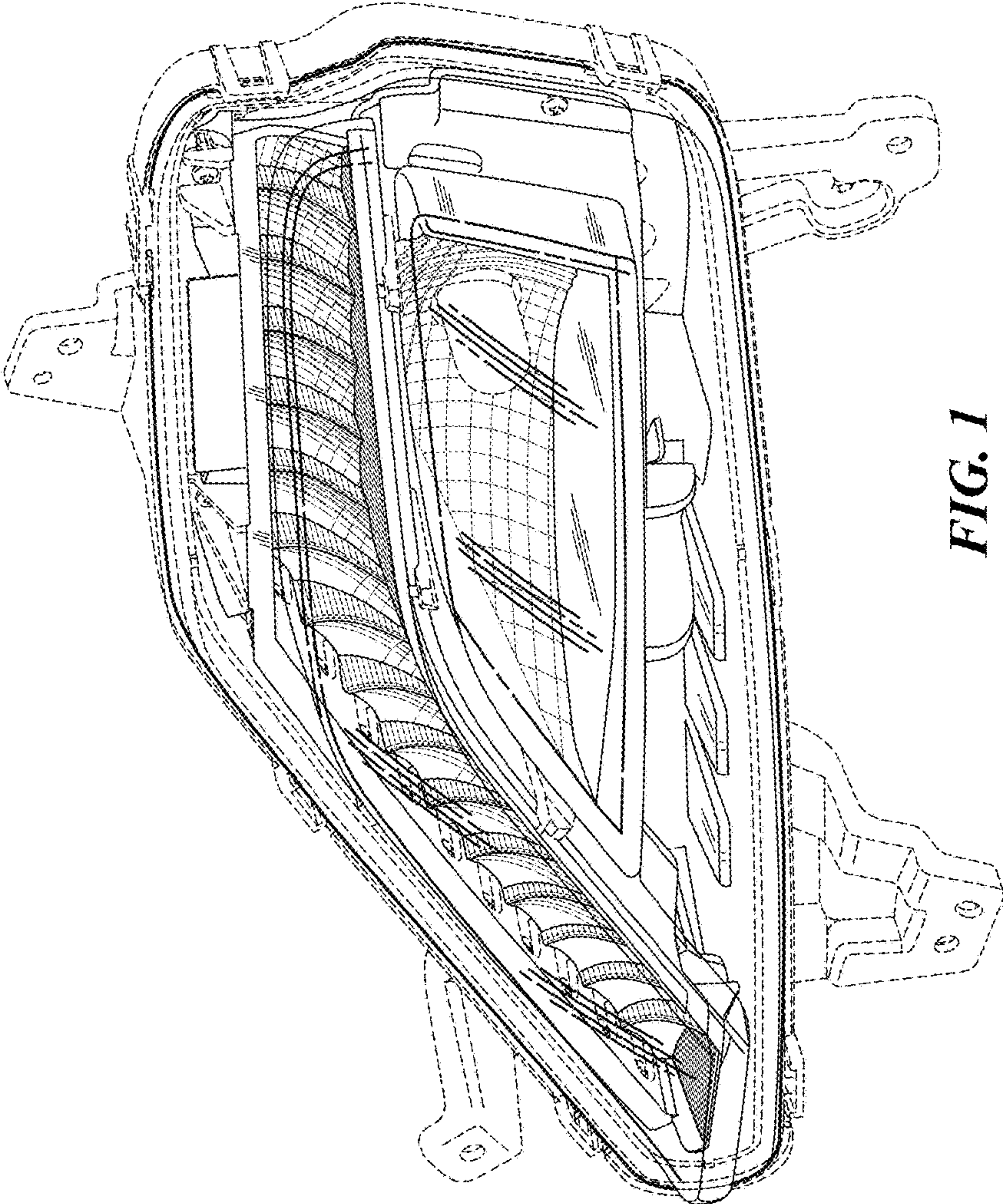
(56)

References Cited

U.S. PATENT DOCUMENTS

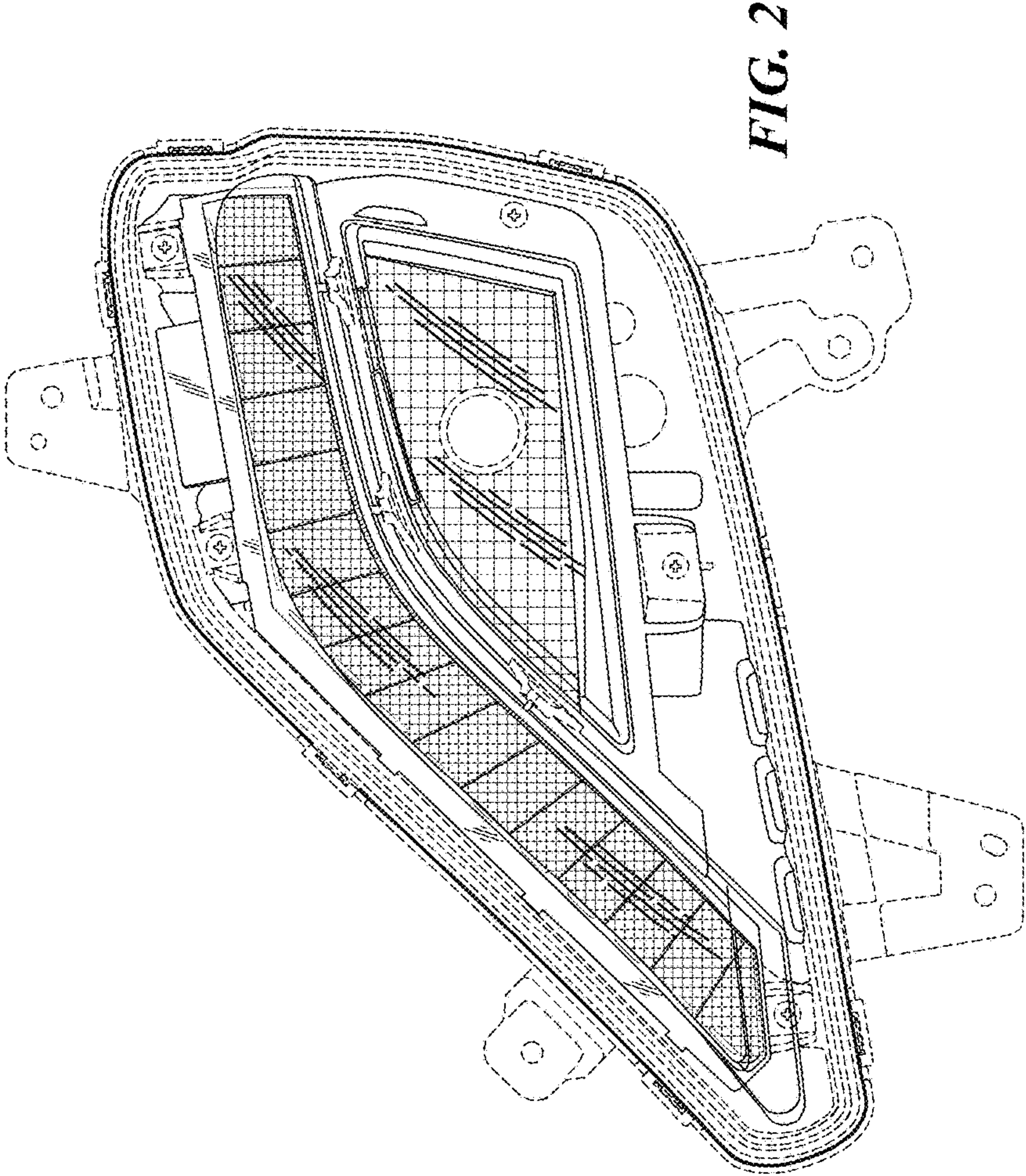
D786,743 S	5/2017	Smith et al.	D795,760 S	8/2017	Kozub et al.
D786,750 S	5/2017	Lee	D795,762 S	8/2017	Lee
D787,446 S	5/2017	Cockerill	D795,763 S	8/2017	Kozub
D787,984 S	5/2017	Fang	D796,088 S	8/2017	McCabe et al.
D787,988 S	5/2017	Lee	D796,093 S	8/2017	Mainville
D787,989 S	5/2017	Kozub et al.	D796,390 S	9/2017	Pevovar et al.
D787,990 S	5/2017	Kozub et al.	D797,537 S	9/2017	Cooper et al.
D787,992 S	5/2017	Lee	D797,603 S	9/2017	Noone et al.
D787,993 S	5/2017	McCabe et al.	D797,614 S	9/2017	Lee
D788,001 S	5/2017	Lee	D797,616 S	9/2017	Lee
D788,641 S	6/2017	Arnold	D797,624 S	9/2017	Nakamura
D788,644 S	6/2017	Mueller	D797,625 S	9/2017	Perkins
D788,645 S	6/2017	Mueller	D797,631 S	9/2017	Pevovar et al.
D789,250 S	6/2017	Arnold	D797,632 S	9/2017	Zipfel et al.
D789,260 S	6/2017	Smith	D797,967 S	9/2017	Barry
D789,575 S	6/2017	Willett	D797,970 S	9/2017	Mainville
D789,841 S	6/2017	Lee	D797,971 S	9/2017	Mainville
D789,849 S	6/2017	Lee	D797,972 S	9/2017	Whitla et al.
D791,018 S	7/2017	Mylenek	D798,204 S	9/2017	Mainville
D791,644 S	7/2017	Fang	D799,384 S	10/2017	Kozub et al.
D792,290 S	7/2017	Smith et al.	D799,385 S	10/2017	Kozub et al.
D792,293 S	7/2017	McCabe et al.	D799,386 S	10/2017	Kozub et al.
D792,294 S	7/2017	McCabe et al.	D799,728 S	10/2017	Whitla et al.
D792,295 S	7/2017	McCabe et al.	D801,236 S	10/2017	Kozub et al.
D792,815 S	7/2017	Kozub	D801,577 S	10/2017	Ruiz
D792,816 S	7/2017	Kozub	D801,882 S	11/2017	Kozub et al.
D793,290 S	8/2017	Kozub	D802,205 S	11/2017	Ruiz
D793,292 S	8/2017	Lee	D802,478 S	11/2017	Perkins
D793,293 S	8/2017	Lee et al.	D802,491 S	11/2017	Mainville
D793,294 S	8/2017	Lee	D802,496 S	11/2017	Mainville
D793,295 S	8/2017	McCabe et al.	D802,502 S	11/2017	McMahan
D793,296 S	8/2017	Smith et al.	D803,727 S	11/2017	Noone et al.
D793,297 S	8/2017	Smith et al.	D803,731 S	11/2017	Zipfel
D793,299 S	8/2017	Krieg et al.	D804,370 S	12/2017	Kozub et al.
D793,300 S	8/2017	Krieg et al.	D804,371 S	12/2017	Whitla et al.
D793,301 S	8/2017	Kozub	D804,372 S	12/2017	Kozub
D793,302 S	8/2017	Kozub	D804,378 S	12/2017	Perkins
D793,311 S	8/2017	Whitla et al.	D804,379 S	12/2017	McMahan
D793,590 S	8/2017	Kozub et al.	D805,006 S	12/2017	Nakamura
D793,591 S	8/2017	Kozub et al.	D805,013 S	12/2017	Whitla
D793,917 S	8/2017	Kozub	D805,014 S	12/2017	Zipfel
D793,918 S	8/2017	Kozub	D805,441 S	12/2017	Karras
D794,229 S	8/2017	Barry	D805,964 S	12/2017	Whitla
D794,230 S	8/2017	Kozub	D805,965 S	12/2017	Davis
D795,747 S	8/2017	Bailie	D805,966 S	12/2017	Perkins
D795,757 S	8/2017	Pevovar et al.	D805,985 S	12/2017	Nakamura
D795,758 S	8/2017	Karras	D807,232 S	1/2018	Bailie
D795,759 S	8/2017	Kozub et al.	D807,239 S	1/2018	Perkins
			D807,240 S	1/2018	Perkins
			D807,241 S	1/2018	Perkins

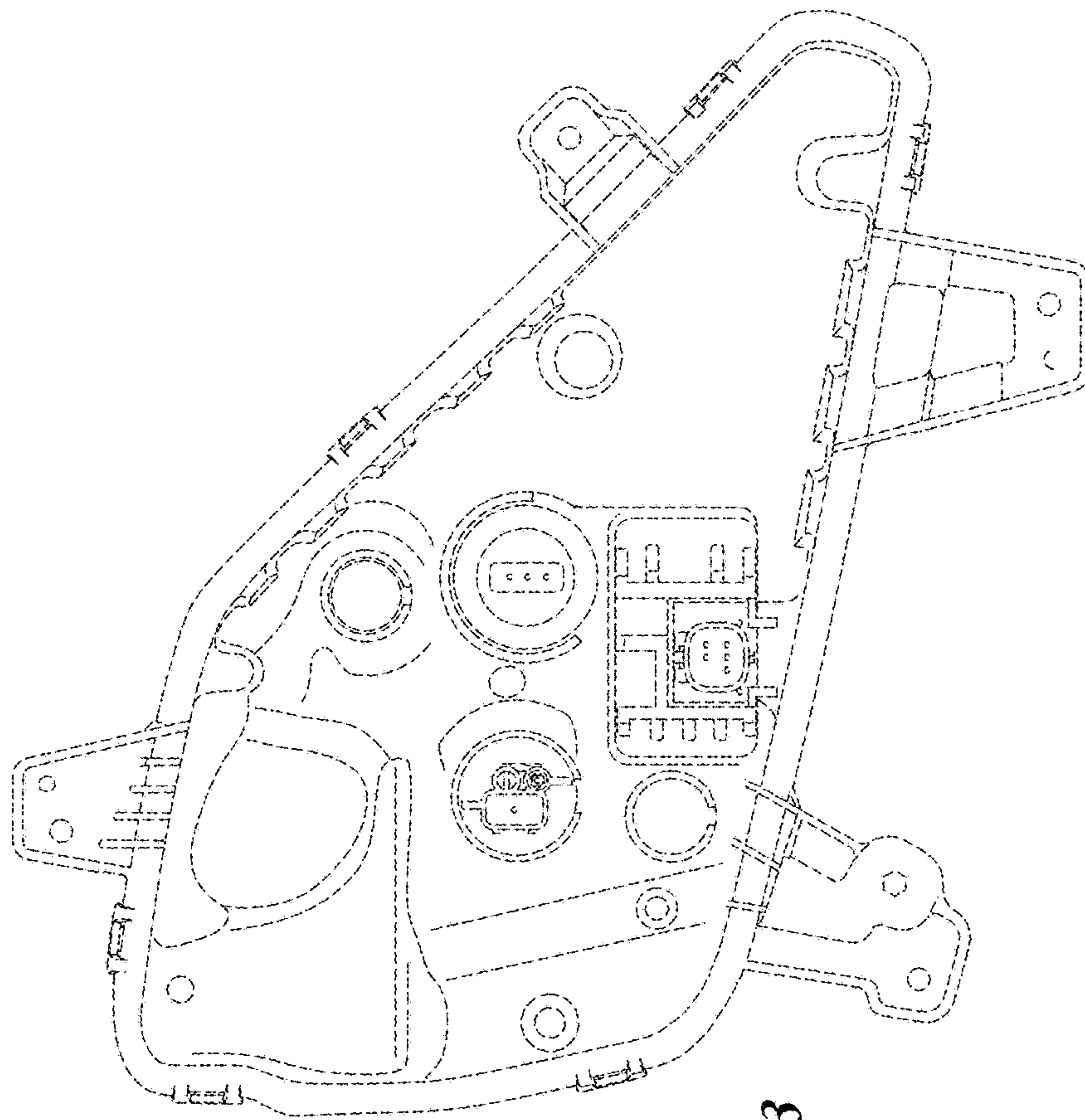
\* cited by examiner



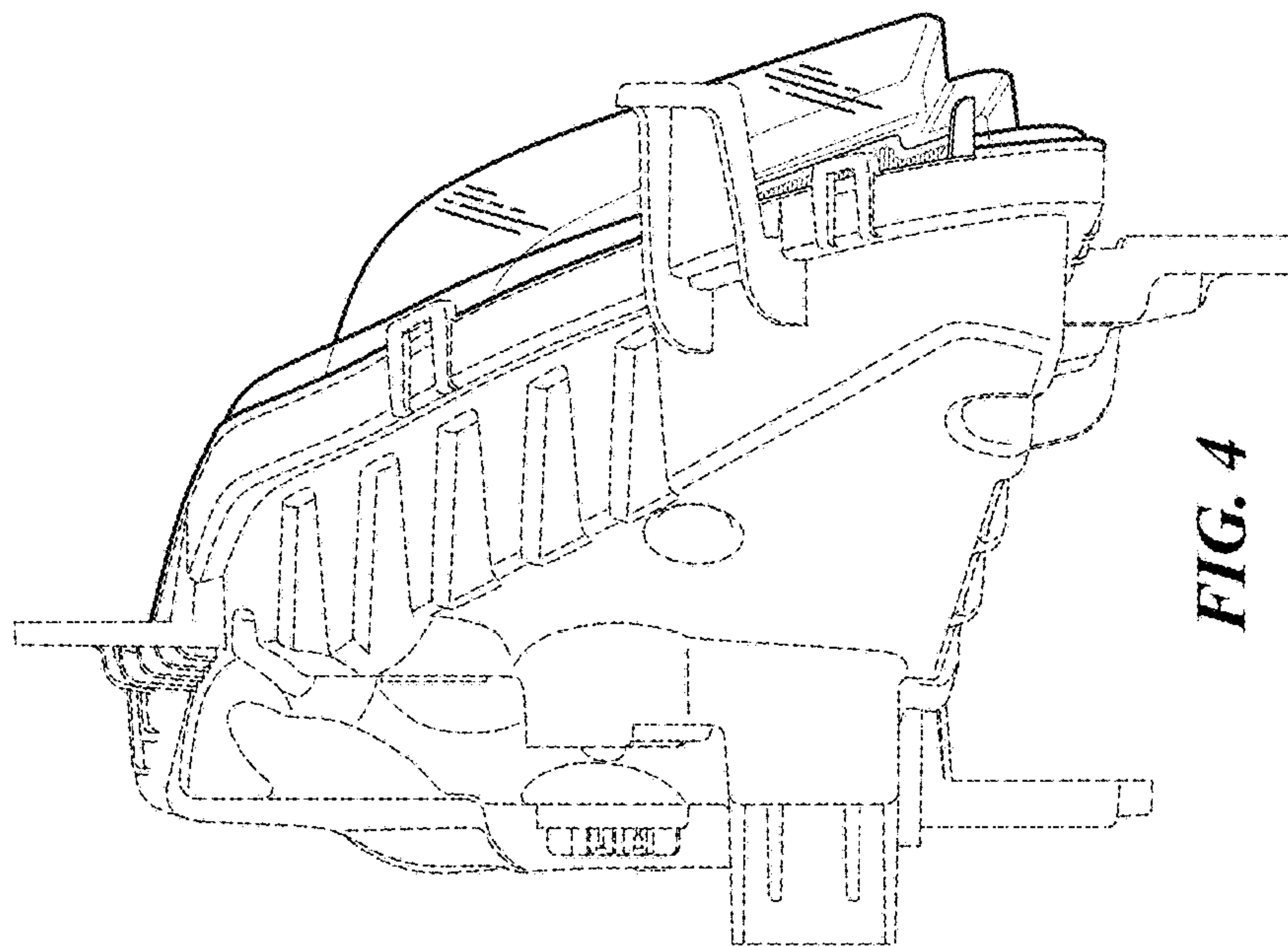
**FIG. 1**



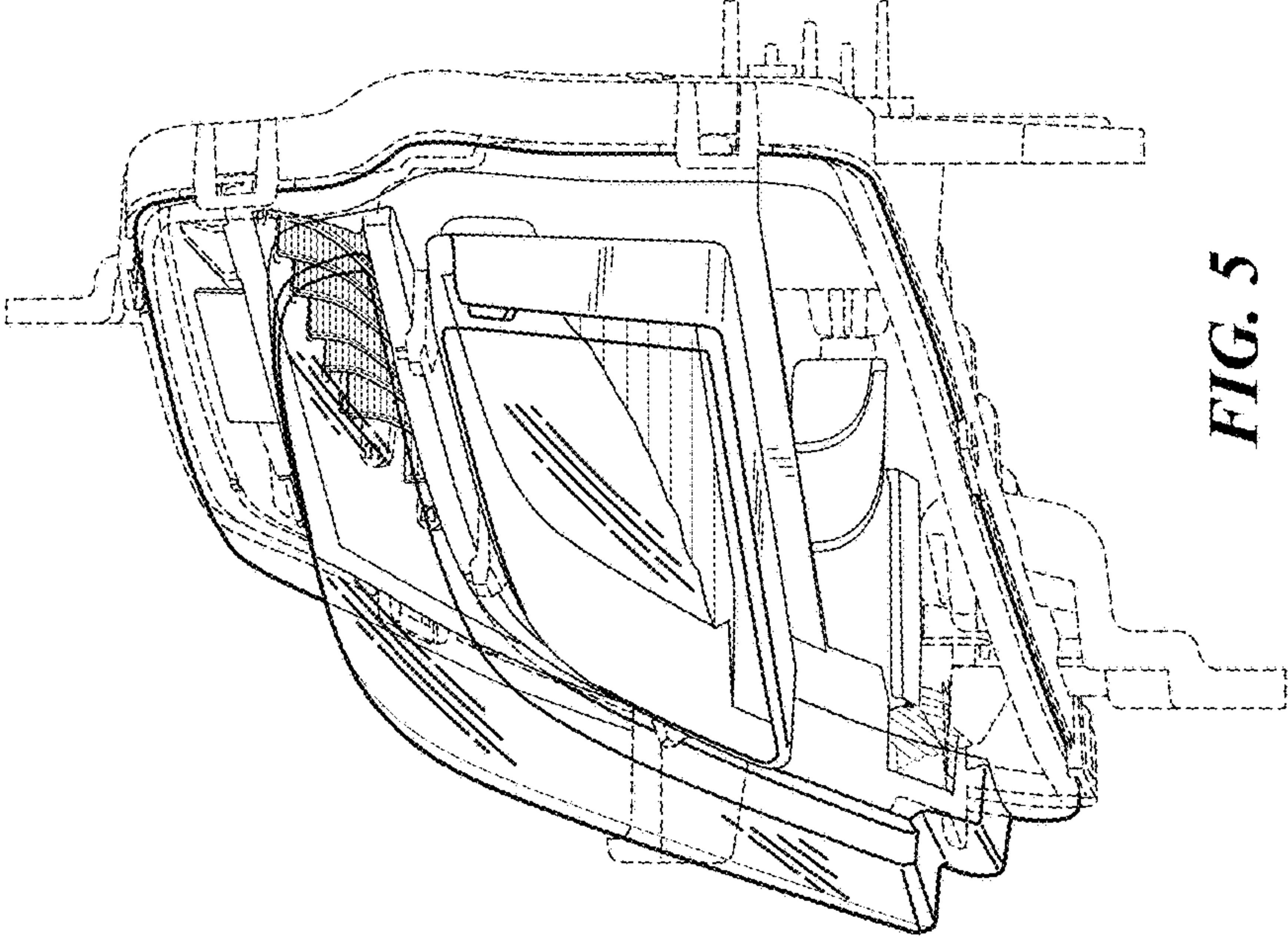




**FIG. 3**



**FIG. 4**



**FIG. 5**



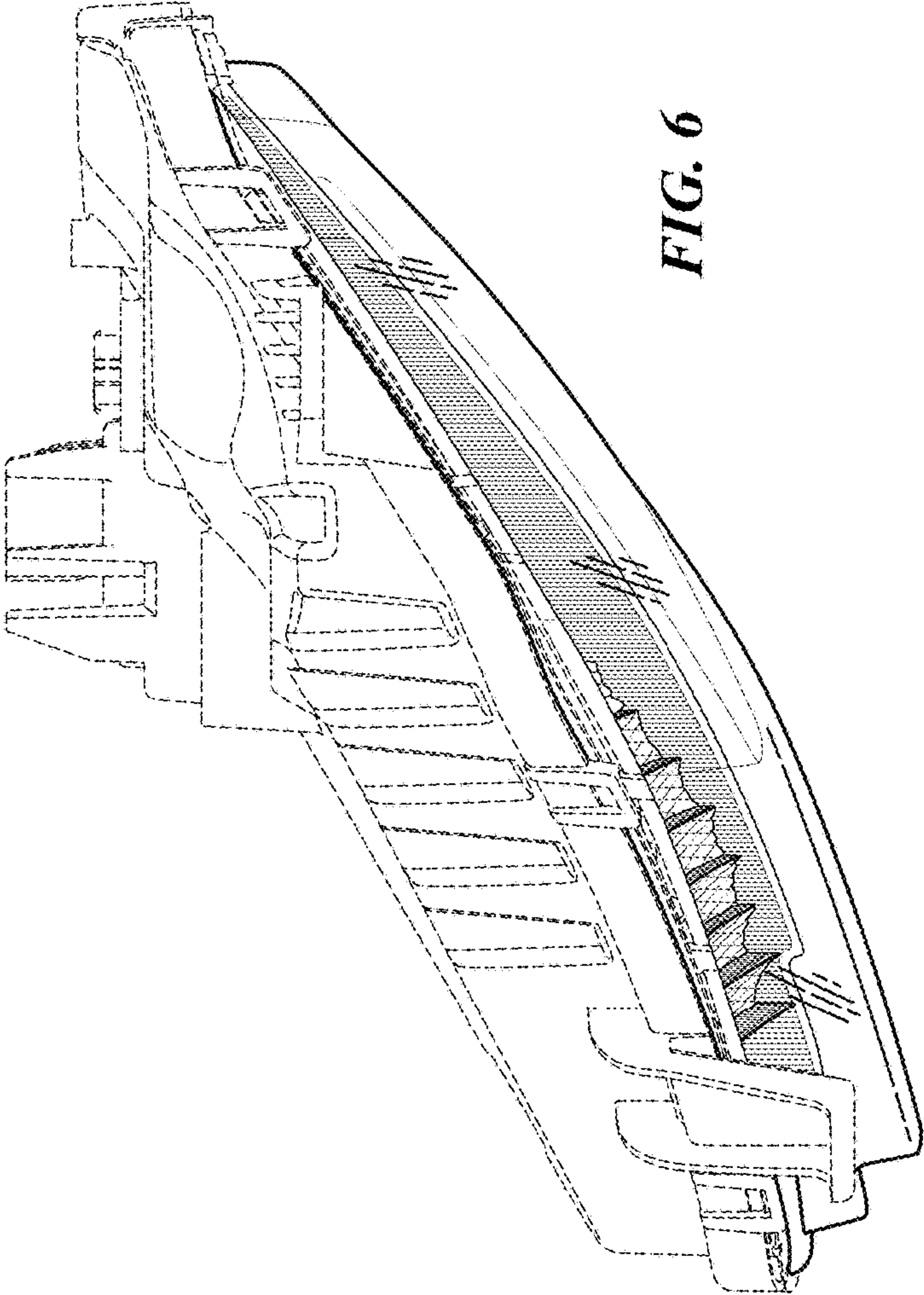
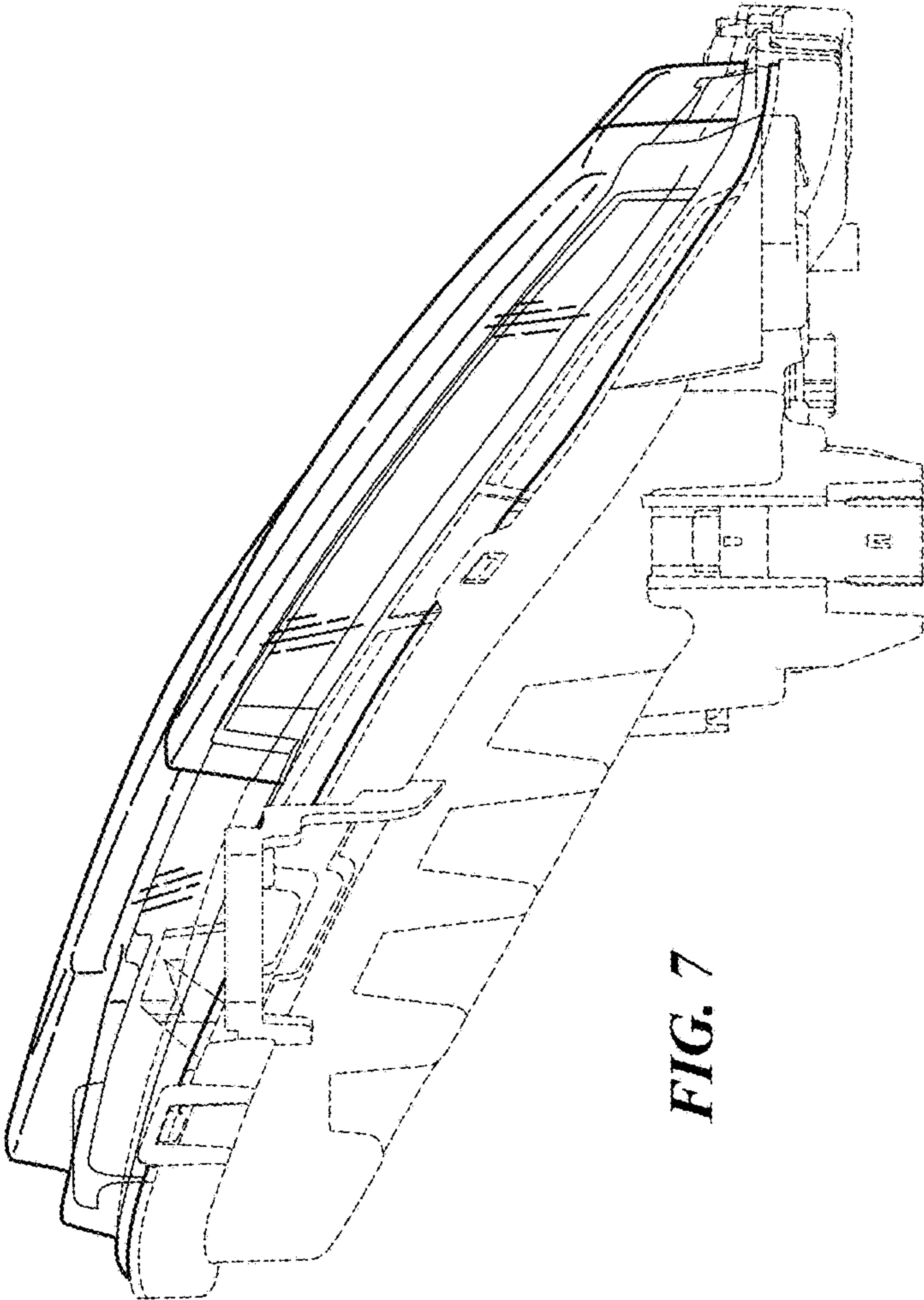


FIG. 6



**FIG. 7**