



US00D842953S

(12) **United States Design Patent**
Chambert

(10) **Patent No.:** **US D842,953 S**
(45) **Date of Patent:** **** Mar. 12, 2019**

- (54) **SPORTING IMPLEMENT**
- (71) Applicant: **Bauer Hockey Ltd.**, Blainville (CA)
- (72) Inventor: **Martin Chambert**, Piedmont (CA)
- (73) Assignee: **Bauer Hockey, LLC**, Exeter, NH (US)
- (**) Term: **15 Years**
- (21) Appl. No.: **29/609,987**
- (22) Filed: **Jul. 7, 2017**
- (51) **LOC (11) Cl.** **21-02**
- (52) **U.S. Cl.**
USPC **D21/757; D21/727**
- (58) **Field of Classification Search**
USPC D21/722-731, 753, 756, 757, 759, 789
CPC A63B 59/70; A63B 53/10; A63B 53/12;
A63B 60/00; A63B 60/46; A63B
2102/22; A63B 2102/24
See application file for complete search history.

5,720,388 A 2/1998 King et al.
D430,249 S * 8/2000 Burger D21/727
D432,610 S * 10/2000 Barila D21/727
6,267,697 B1 * 7/2001 Sulenta A63B 59/70
473/560

(Continued)

FOREIGN PATENT DOCUMENTS

BE 901416 A2 4/1985
CA 933965 A 9/1973

(Continued)

OTHER PUBLICATIONS

U.S. Appl. No. 29/609,994, filed Jul. 7, 2017, by inventor Martin Chambert.

(Continued)

Primary Examiner — Mitchell I. Siegel
(74) *Attorney, Agent, or Firm* — Banner & Witcoff, Ltd.

(57) **CLAIM**

The ornamental design for a sporting implement, as shown and described.

DESCRIPTION

FIG. 1 is a top, right, rear perspective view of a sporting implement showing my new design;
FIG. 2 is a rear view thereof;
FIG. 3 is a front view thereof;
FIG. 4 is a left side view thereof;
FIG. 5 is a right side view thereof;
FIG. 6 is a cross-sectional view at 6-6 in FIG. 2 thereof; and,
FIG. 7 is a cross-sectional view at 7-7 in FIG. 2 thereof.
The uneven-length broken lines represent unclaimed boundaries of the claimed design. The even-length broken lines showing the remainder of the sporting implement represent unclaimed subject matter and form no part of the claimed design.

1 Claim, 7 Drawing Sheets

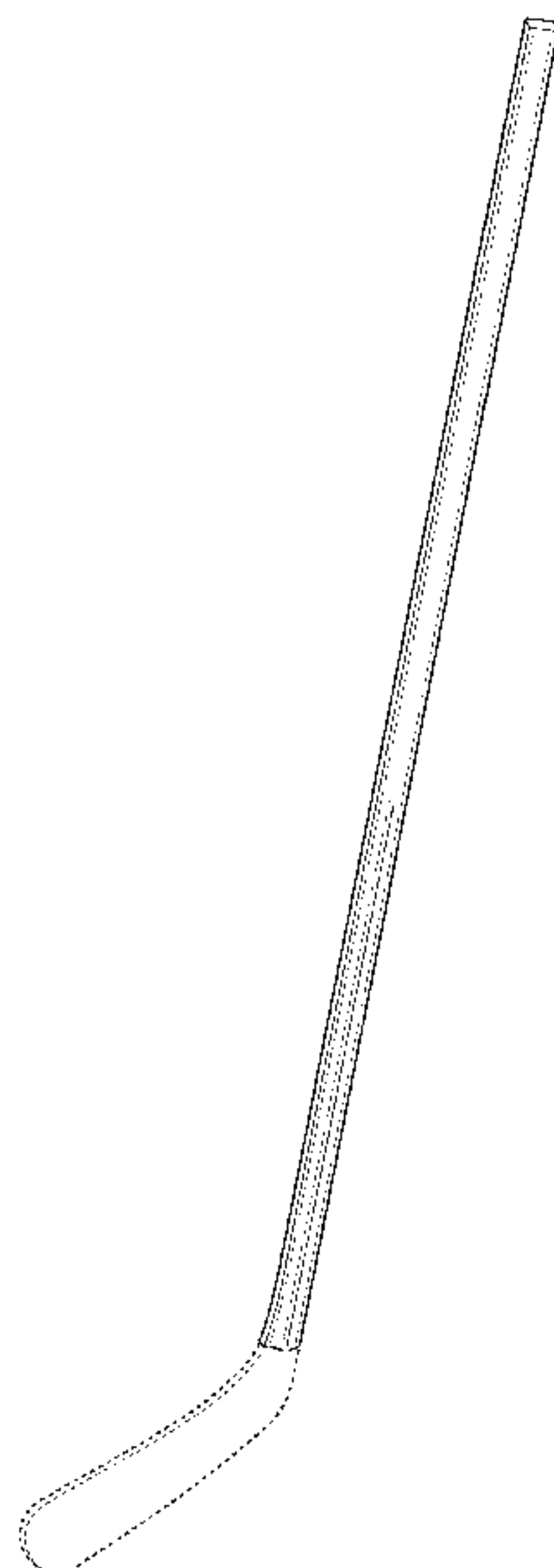

(56) **References Cited**

U.S. PATENT DOCUMENTS

- D206,234 S 11/1966 Sasse
- D244,219 S * 5/1977 Poirier 473/560
- D244,220 S * 5/1977 De brey 473/560
- 4,116,440 A 9/1978 Takeshima
- 4,470,599 A 9/1984 Usher, Jr.
- 4,629,191 A * 12/1986 Mancuso A63B 53/14
473/203
- 4,964,192 A 10/1990 Marui
- 5,217,380 A 6/1993 Martinet
- 5,306,003 A * 4/1994 Pagotto A63B 60/08
473/303
- 5,460,372 A 10/1995 Cook
- 5,575,724 A * 11/1996 Hannon A63B 53/007
473/303
- 5,577,725 A * 11/1996 Pagotto A63B 59/70
473/560

(56)

References Cited

U.S. PATENT DOCUMENTS

D458,329 S * 6/2002 Clark, Jr. D21/727
 D476,049 S * 6/2003 Sultenta D21/727
 D484,555 S * 12/2003 Bellefleur D21/727
 6,820,654 B2 11/2004 Lindsay
 D504,166 S * 4/2005 Bellefleur D21/727
 D504,929 S * 5/2005 Bellefleur D21/727
 6,953,405 B2 10/2005 LeMire et al.
 7,008,687 B2 3/2006 Wang
 D534,227 S 12/2006 Lee
 7,201,678 B2 4/2007 Filice et al.
 D544,932 S 6/2007 Scott
 7,285,063 B2 10/2007 Lussier et al.
 7,331,876 B2 2/2008 Klein
 D565,140 S 3/2008 Appleton et al.
 7,404,775 B2 7/2008 Morrow et al.
 D581,474 S 11/2008 Dickie et al.
 D581,475 S 11/2008 Dickie et al.
 D589,099 S * 3/2009 Purnell D21/724
 D589,101 S 3/2009 Dickie et al.
 D589,102 S 3/2009 Dickie et al.
 D594,516 S * 6/2009 Giblin D21/727
 D594,920 S * 6/2009 Drouin D21/727
 D595,368 S * 6/2009 Drouin D21/727
 D595,792 S * 7/2009 Drouin D21/727
 7,584,571 B2 9/2009 Ryan
 7,614,969 B2 11/2009 Meyer et al.
 7,651,418 B2 1/2010 Appleton et al.
 D610,641 S * 2/2010 Solin D21/727
 7,931,549 B2 4/2011 Pearson et al.
 D654,129 S * 2/2012 Garcia D21/757
 D688,342 S 8/2013 Tucker, Jr. et al.

D752,167 S 3/2016 Chorne
 9,283,454 B2 3/2016 Bond
 D770,581 S * 11/2016 Gosselin D21/727
 D775,289 S * 12/2016 Crouchen D21/727
 9,757,631 B2 * 9/2017 Lacey A63B 59/70
 D808,480 S * 1/2018 Plug D21/727
 D808,481 S * 1/2018 Plug D21/727
 2004/0087395 A1 * 5/2004 Manory A63B 60/06
 473/560
 2005/0130759 A1 6/2005 Hayden et al.
 2005/0215364 A1 * 9/2005 Lussier A63B 59/70
 473/560
 2006/0046866 A1 3/2006 Rigoli
 2011/0028250 A1 * 2/2011 Pearson A63B 59/70
 473/562
 2011/0237363 A1 9/2011 Chang
 2012/0193021 A1 8/2012 Botten et al.
 2017/0246519 A1 8/2017 Lacey et al.

FOREIGN PATENT DOCUMENTS

CA 1151693 A 8/1983
 CA 2506213 A1 11/2005
 CA 2674172 C 2/2014
 CA 2793353 A1 4/2014
 CA 2954993 A1 1/2016

OTHER PUBLICATIONS

U.S. Appl. No. 29/609,996, filed Jul. 7, 2017, by inventor Martin Chambert.

* cited by examiner

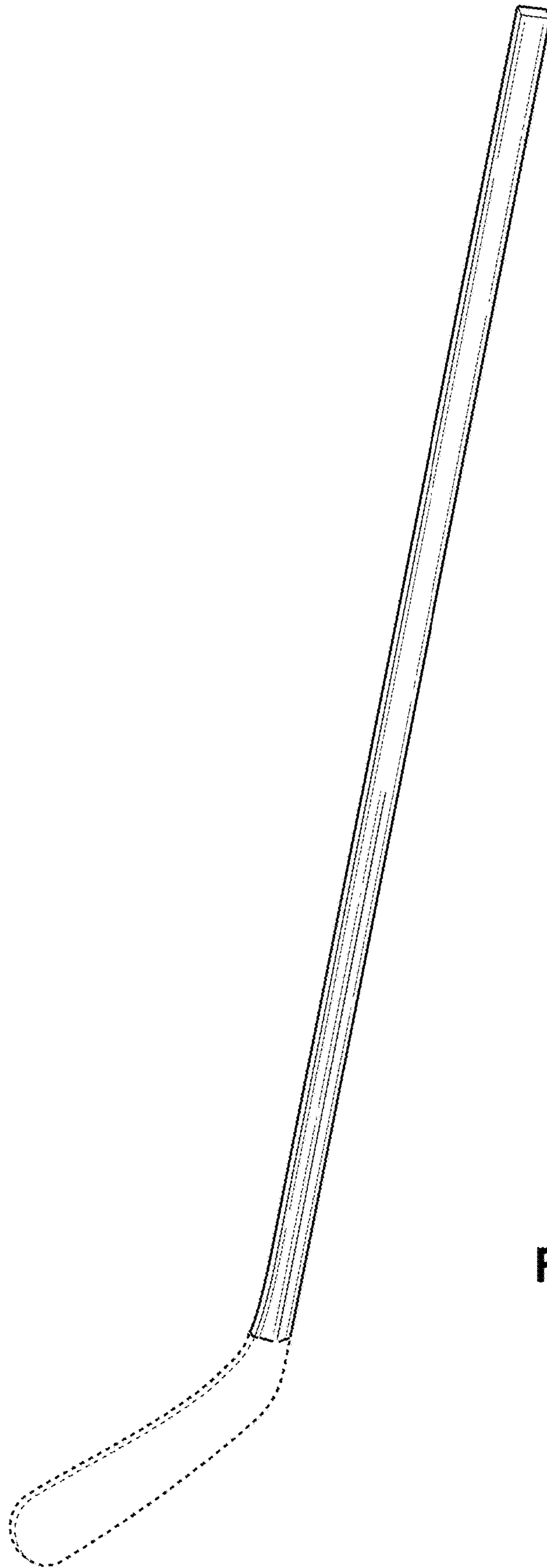

FIG. 1

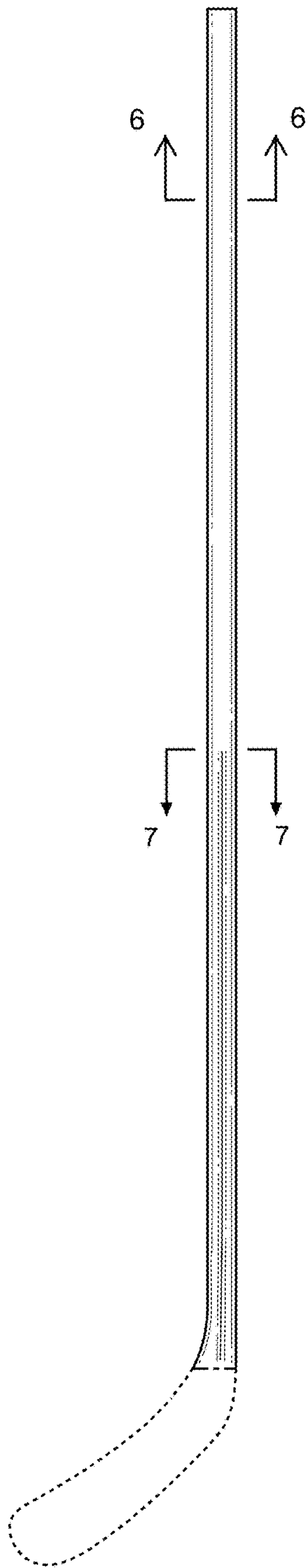

FIG. 2

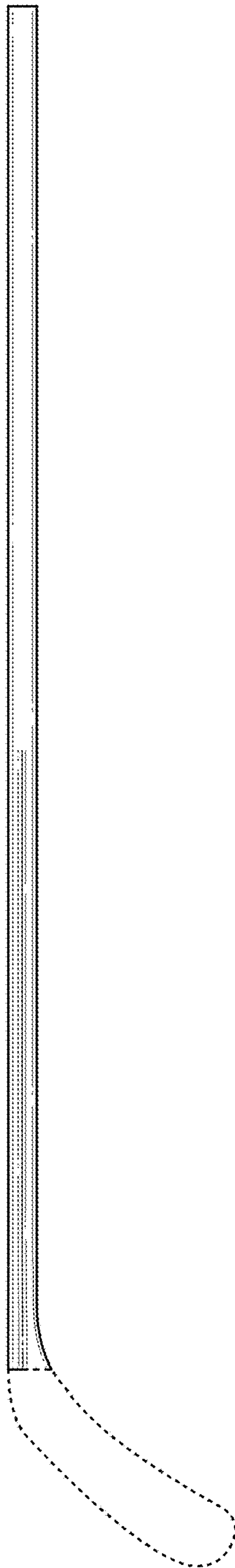

FIG. 3



FIG. 4



FIG. 5



FIG. 6

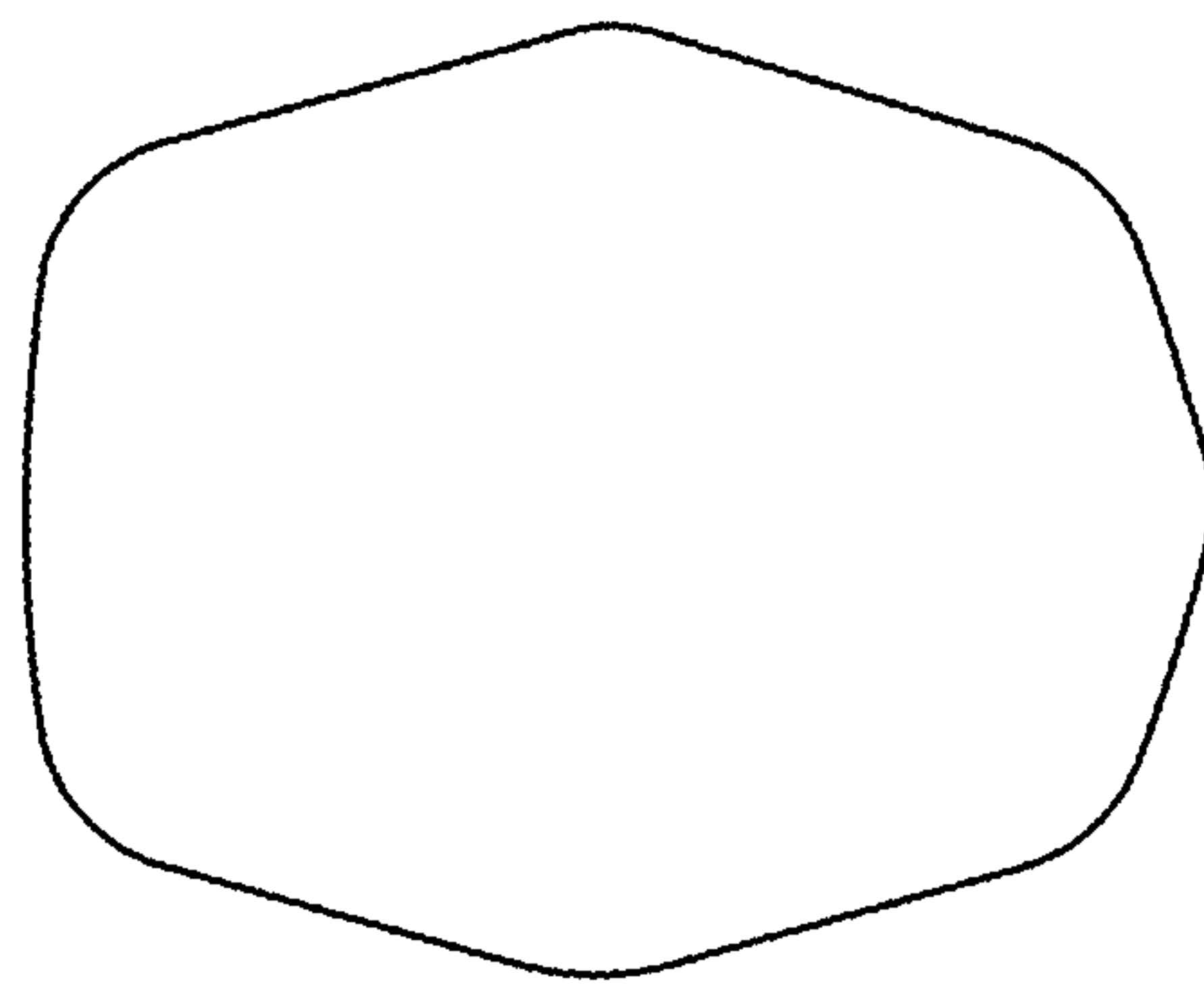

FIG. 7