

US00D842838S

(12) **United States Design Patent**
Li

(10) **Patent No.:** **US D842,838 S**

(45) **Date of Patent:** **** Mar. 12, 2019**

(54) **HEADSET**

(71) Applicant: **Qunru Li**, Guangdong (CN)

(72) Inventor: **Qunru Li**, Guangdong (CN)

(**) Term: **15 Years**

(21) Appl. No.: **29/619,440**

(22) Filed: **Sep. 29, 2017**

(51) **LOC (11) Cl.** **14-01**

(52) **U.S. Cl.**

USPC **D14/205**

(58) **Field of Classification Search**

USPC D14/205, 223, 371; 181/129, 130, 135;
379/430, 431; 381/380, 381, 74, 384,
381/385, 151; 345/7, 8; 455/90.3, 575.1,
455/569.1

CPC H04R 1/105; H04R 1/10; H04R 25/00;
H04R 1/1066; H04R 1/02; H04R 1/1041;
H04R 5/033; H04R 5/0335

See application file for complete search history.

(56) **References Cited**

U.S. PATENT DOCUMENTS

2,501,107	A *	3/1950	Volkman	H04R 5/0335	381/374
2,891,116	A *	6/1959	Nichols	H04R 25/60	381/323
3,863,028	A *	1/1975	Fixler	H04R 1/1075	381/19
4,110,583	A *	8/1978	Lepper	H04M 1/05	381/370
4,821,318	A *	4/1989	Wu	H04M 1/05	379/430
D371,558	S *	7/1996	Yoshizawa	D14/205	
5,749,373	A *	5/1998	Dix	A61F 11/12	128/864
5,829,062	A *	11/1998	Magidson	A61F 11/12	2/209

6,010,216	A *	1/2000	Jesiek	H04B 1/385	351/158
6,123,168	A *	9/2000	Berg	F16C 11/12	128/866
6,233,345	B1 *	5/2001	Urwyler	H04R 1/1033	351/123
D457,515	S *	5/2002	Masamitsu	D14/192	
D458,245	S *	6/2002	Masuda	D14/192	
D471,176	S *	3/2003	Suzuki	D14/205	
6,603,863	B1 *	8/2003	Nagayoshi	H04R 1/1066	381/370
D492,943	S *	7/2004	Komiyama	D14/205	
7,010,139	B1 *	3/2006	Smeehuyzen	H04R 1/10	381/376
D557,685	S *	12/2007	Lee	D14/205	
D573,581	S *	7/2008	Gondo	D14/205	
D575,268	S *	8/2008	Christopher	D14/205	
D587,679	S *	3/2009	Komiyama	D14/205	
D590,810	S *	4/2009	Komiyama	D14/205	
D593,067	S *	5/2009	Millora	D14/205	

(Continued)

Primary Examiner — Paula Allen Greene

(57) **CLAIM**

The ornamental design for a headset, as shown and described.

DESCRIPTION

FIG. 1 is a perspective view of a headset showing my new design;
FIG. 2 is a front elevational view thereof;
FIG. 3 is a rear elevational view thereof;
FIG. 4 is a left side elevational view thereof;
FIG. 5 is a right side elevational view thereof;
FIG. 6 is a top plan view thereof;
FIG. 7 is a bottom plan view thereof;
FIG. 8 is a perspective view of the headset showing earbuds being pulled out; and,
FIG. 9 is a perspective view of the headset showing hinges being folded.

1 Claim, 9 Drawing Sheets

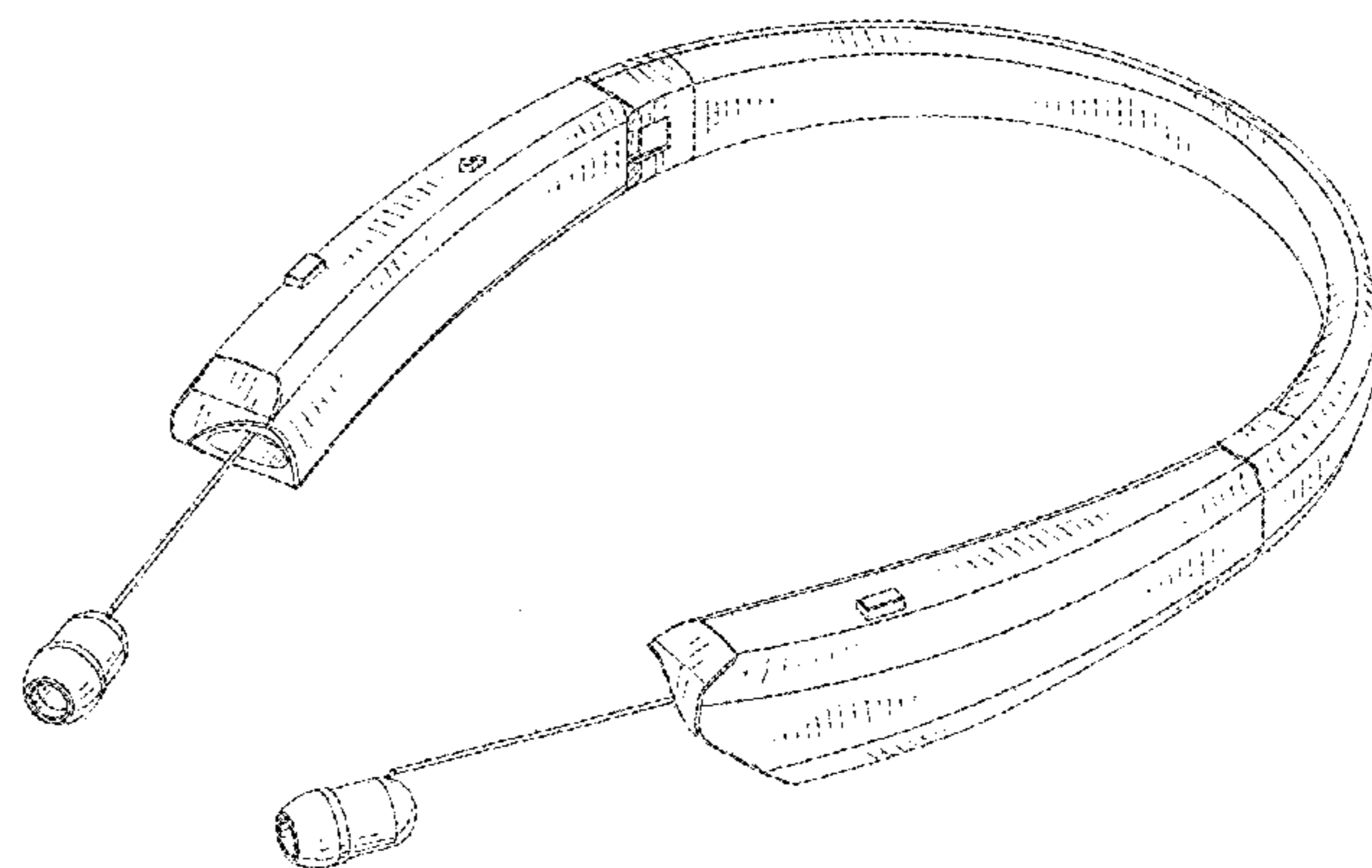
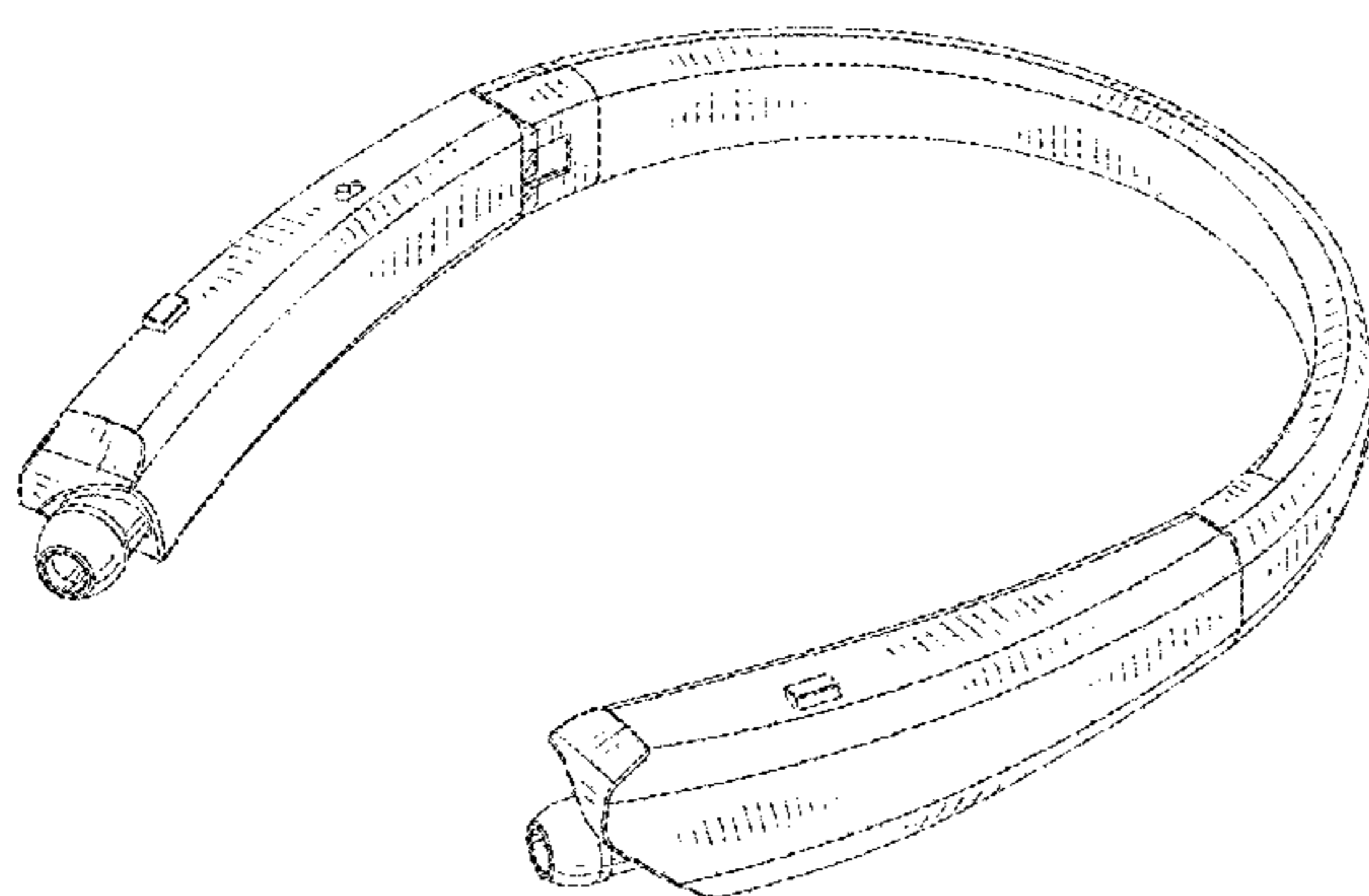

(56)

References Cited

U.S. PATENT DOCUMENTS

D604,269 S *	11/2009	Choe	D14/205	D795,836 S *	8/2017	Liden	D14/205
D633,471 S *	3/2011	Sugiyama	D14/205	D800,088 S *	10/2017	Kim	D14/205
D653,234 S *	1/2012	Lee	D14/205	D800,089 S *	10/2017	Park	D14/205
D665,008 S *	8/2012	Olsson	D16/300	D800,090 S *	10/2017	Ahn	D14/205
8,290,193 B2 *	10/2012	Pang	H04R 1/1033	D802,557 S *	11/2017	Kumano	D14/205
			381/370	D802,558 S *	11/2017	Kim	D14/205
8,433,082 B2 *	4/2013	Abolfathi	H04R 1/46	D803,186 S *	11/2017	Park	D14/205
			381/151	D810,719 S *	2/2018	Nagamine	D14/205
D685,764 S *	7/2013	Coulter	D14/205	D815,068 S *	4/2018	Huang	D14/223
D716,759 S *	11/2014	Ha	D14/205	D816,636 S *	5/2018	Birger	D14/205
D721,673 S *	1/2015	Park	D14/205	9,973,842 B2 *	5/2018	Kim	H04R 1/1025
8,934,654 B2 *	1/2015	Fullam	H04R 1/028	D820,811 S *	6/2018	Kim	D14/205
			381/381	D820,816 S *	6/2018	Singh	D14/223
D726,649 S *	4/2015	Lee	D13/103	D823,828 S *	7/2018	Park	D14/205
D730,867 S *	6/2015	Park	D14/205	D824,361 S *	7/2018	Park	D14/205
D731,999 S *	6/2015	Cepress	D14/205	D824,877 S *	8/2018	Kim	D14/205
D743,933 S *	11/2015	Park	D14/205	D826,898 S *	8/2018	Kim	D14/205
D745,490 S *	12/2015	Zheng	D14/205	D826,899 S *	8/2018	Ahn	D14/205
D762,617 S *	8/2016	Park	D14/205	D830,335 S *	10/2018	Shin	D14/205
D766,869 S *	9/2016	Lee	D14/205	2011/0170702 A1 *	7/2011	Bays	H04R 5/0335
9,445,181 B1 *	9/2016	Atwater	H04R 1/105				381/74
D768,600 S *	10/2016	Chen	D14/205	2013/0156250 A1 *	6/2013	Hsu Huang	H04R 1/1075
D771,013 S *	11/2016	Yang	D14/205				381/385
D771,588 S *	11/2016	Choe	D14/205	2013/0329903 A1 *	12/2013	Ting	H04R 1/105
D772,843 S *	11/2016	Lee	D14/205				381/74
D772,845 S *	11/2016	Lim	D14/205	2015/0264474 A1 *	9/2015	Seo	G06F 3/165
D774,017 S *	12/2016	Ahn	D14/205				381/74
D776,636 S *	1/2017	Lim	D14/205	2016/0050487 A1 *	2/2016	Kim	H04R 1/323
D777,136 S *	1/2017	Erbeus	D14/205				381/74
D781,815 S *	3/2017	Choi	D14/205	2016/0366506 A1 *	12/2016	Kim	H04R 5/0335
D781,816 S *	3/2017	Choe	D14/205	2017/0070801 A1 *	3/2017	Nguyen	H04R 1/105
D793,357 S *	8/2017	Afshar	D14/205	2017/0195768 A1 *	7/2017	Kim	H04B 1/034
D793,358 S *	8/2017	Lee	D14/205	2017/0311072 A1 *	10/2017	Seo	H04M 1/02
				2017/0347192 A1 *	11/2017	Seo	H04R 5/02
				2018/0063620 A1 *	3/2018	Kim	H04R 1/1025

* cited by examiner

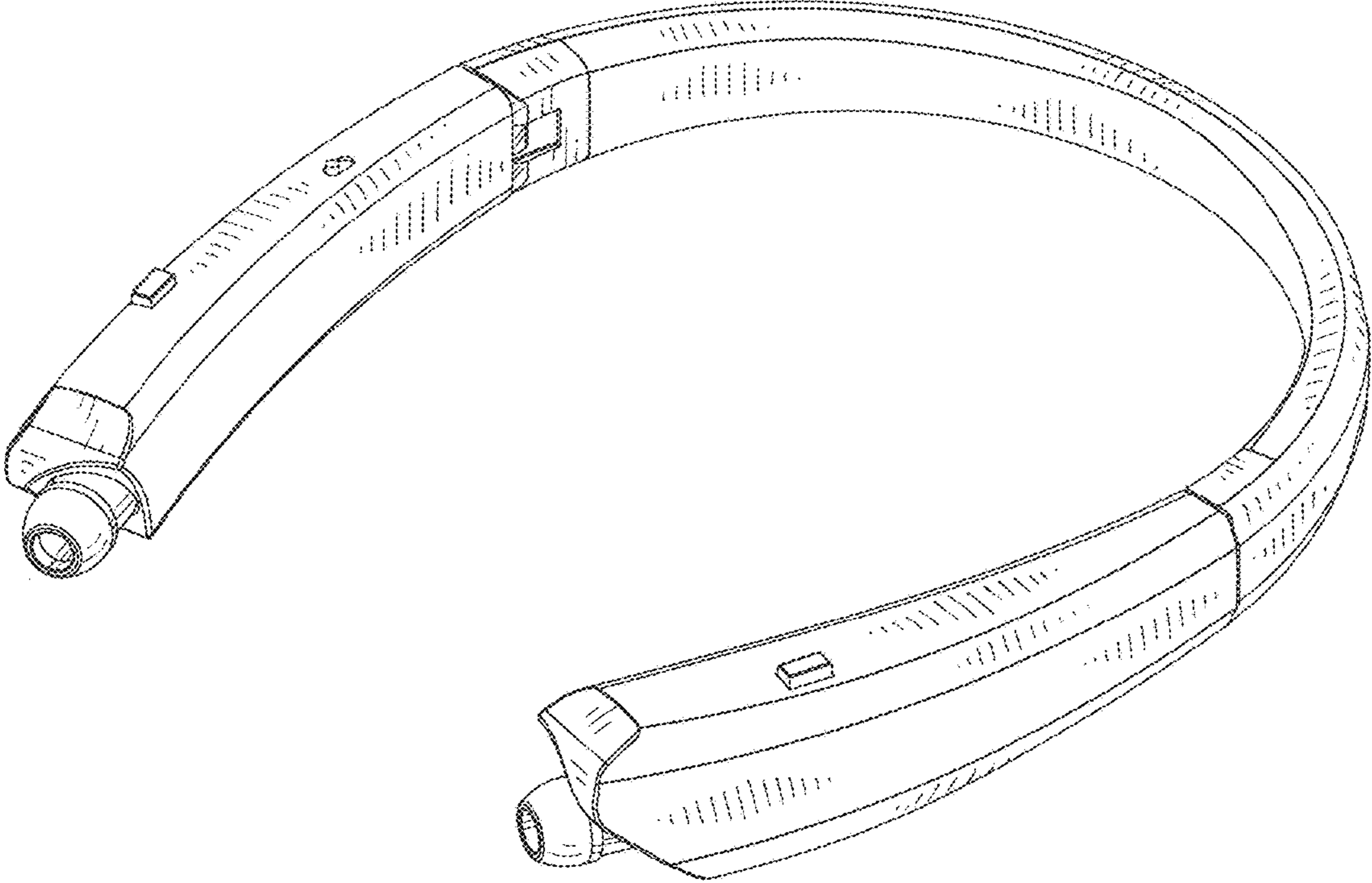

Fig.1

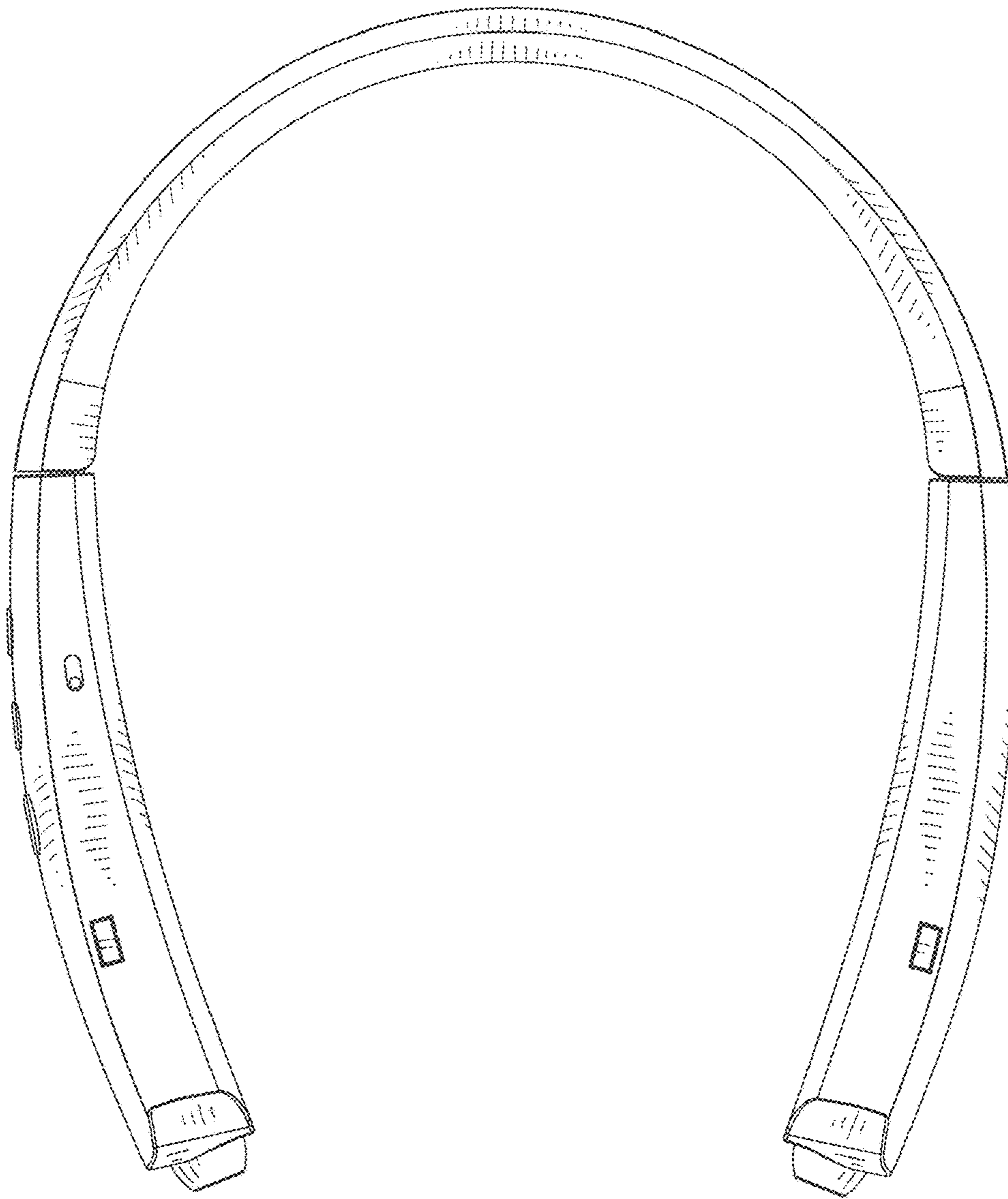

Fig.2

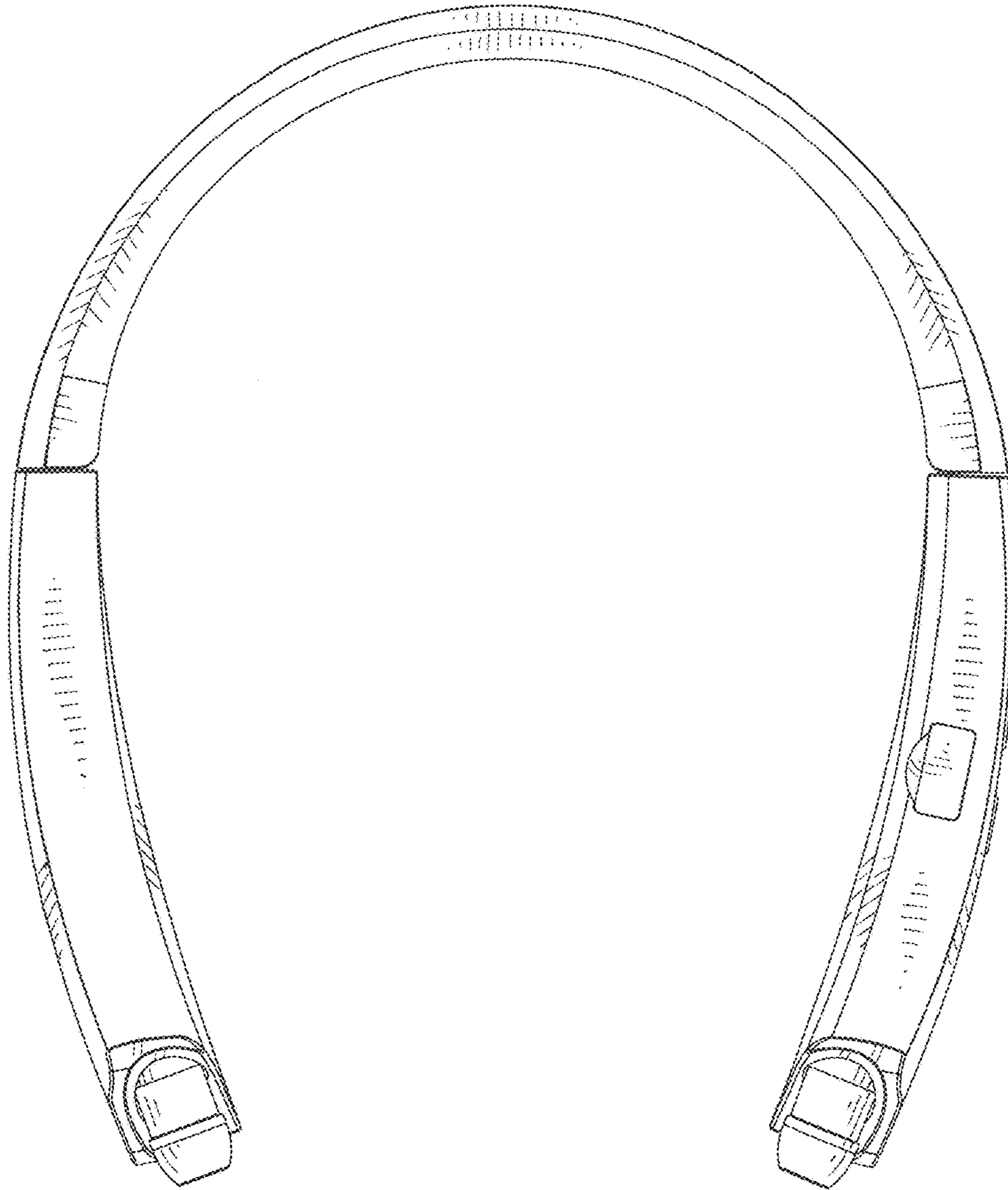

Fig.3

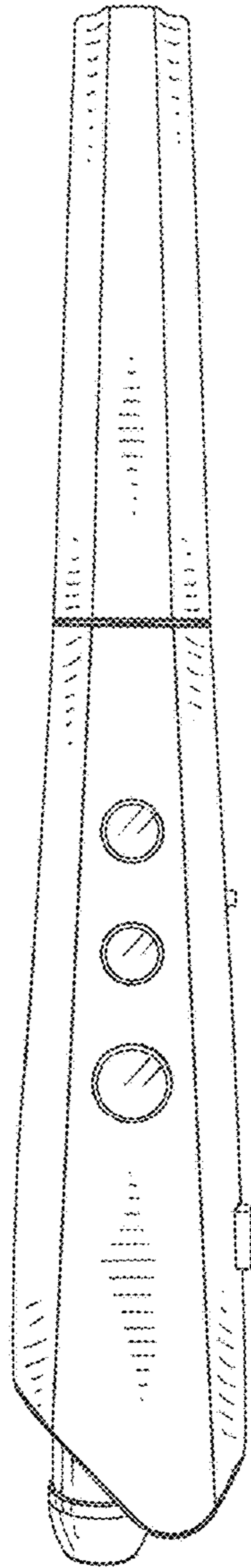

Fig.4

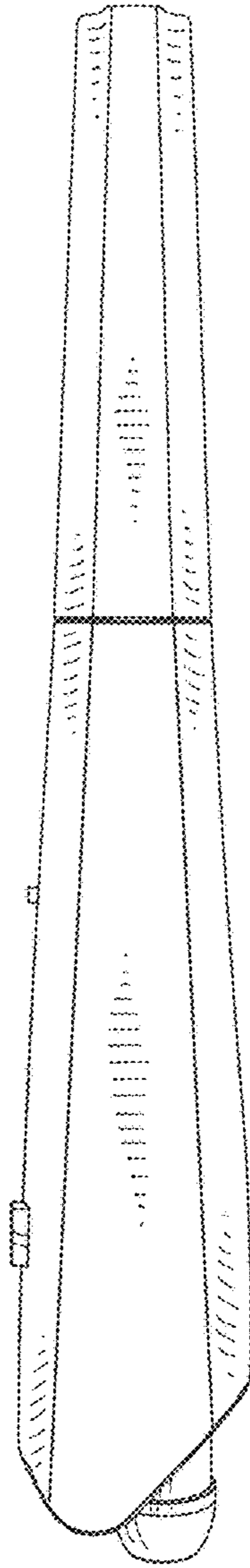

Fig.5

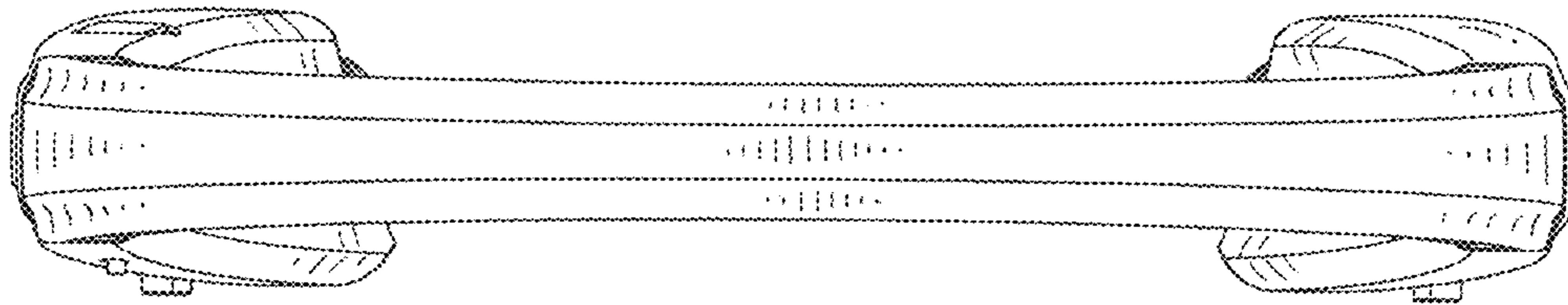

Fig.6

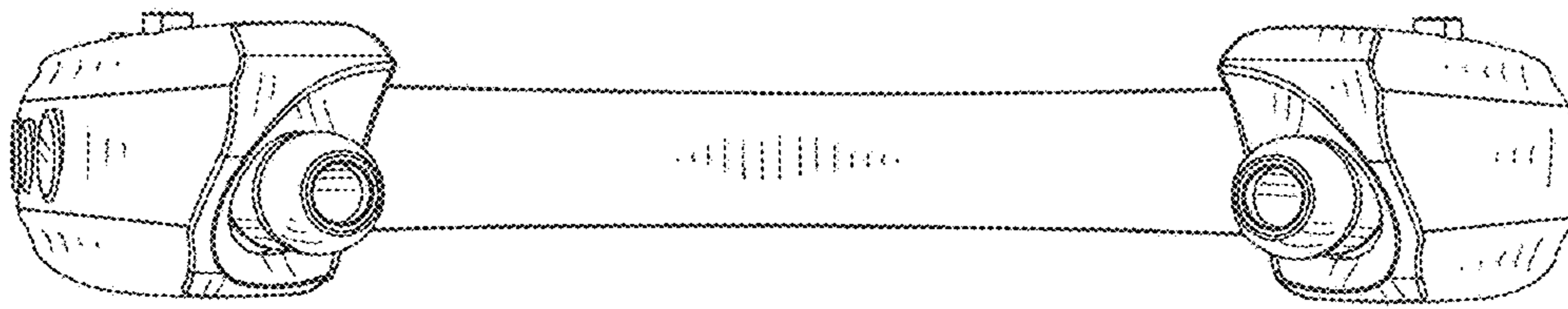

Fig.7

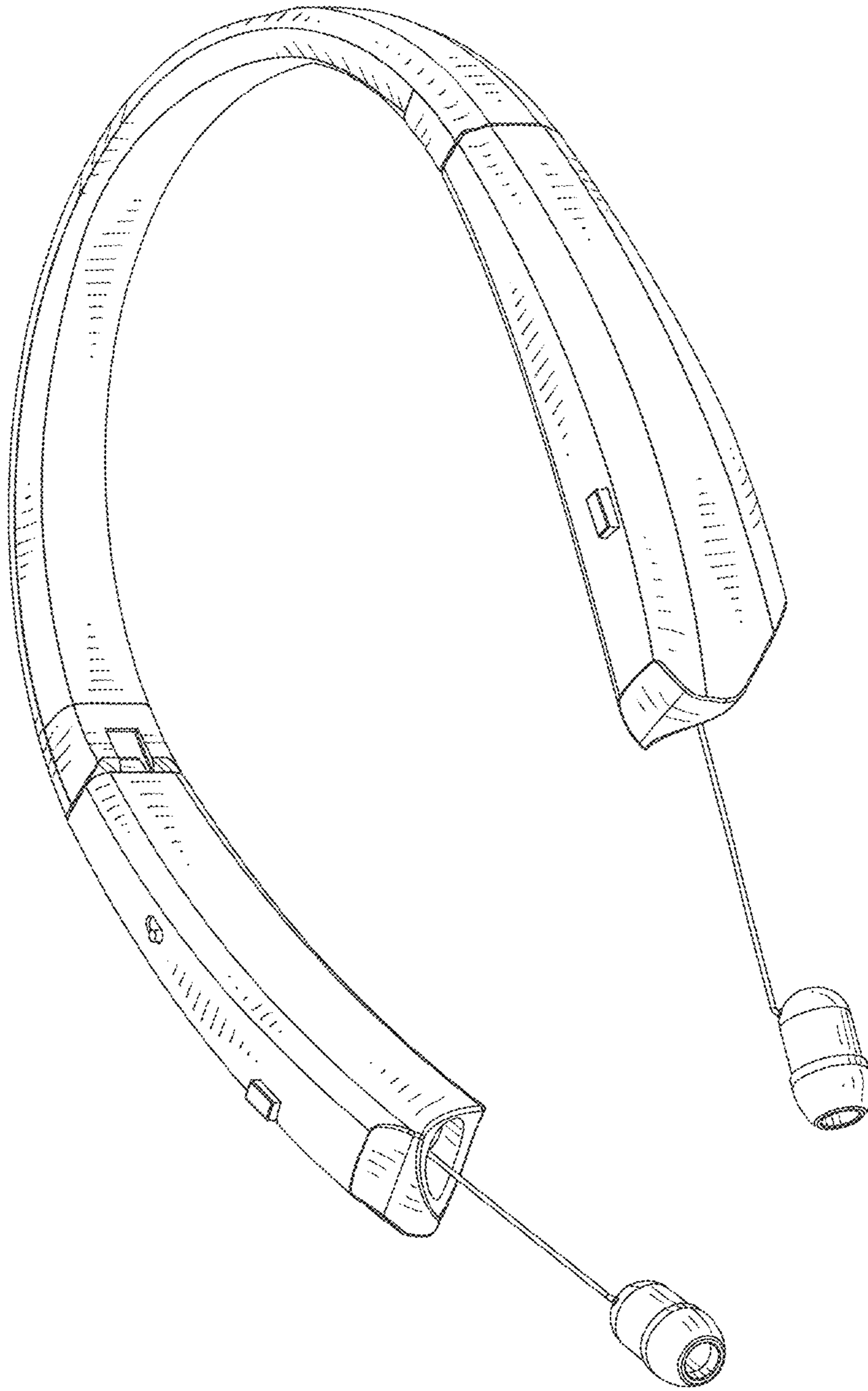

Fig. 8

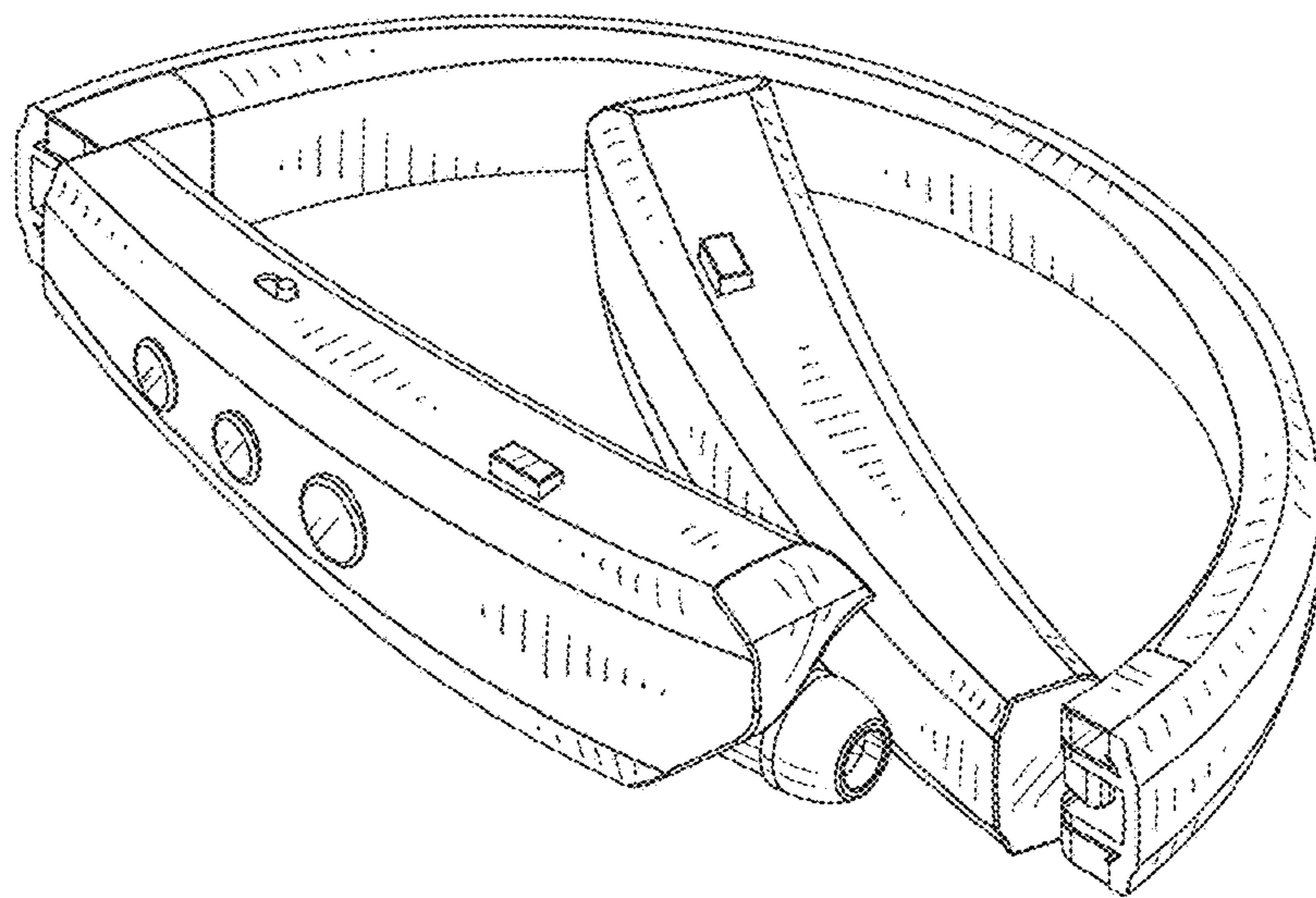

Fig.9