



US00D842693S

(12) **United States Design Patent**
Janes et al.

(10) **Patent No.:** **US D842,693 S**
(45) **Date of Patent:** **** Mar. 12, 2019**

- (54) **PACKAGE**
- (71) Applicant: **Kimberly-Clark Worldwide, Inc.**,
Neenah, WI (US)
- (72) Inventors: **Shawn Michael Janes**, Neenah, WI
(US); **Kathleen M. Breen**, Neenah, WI
(US); **Kindra K. Bolsinger**, Cincinnati,
OH (US)
- (73) Assignee: **Kimberly-Clark Worldwide, Inc.**,
Neenah, WI (US)
- (**) Term: **15 Years**
- (21) Appl. No.: **29/634,826**
- (22) Filed: **Jan. 25, 2018**

Related U.S. Application Data

- (62) Division of application No. 29/589,150, filed on Dec. 28, 2016, now Pat. No. Des. 812,466.
- (51) **LOC (11) Cl.** **09-07**
- (52) **U.S. Cl.**
USPC **D9/434; D9/432; D9/416**
- (58) **Field of Classification Search**
USPC D9/414–423, 430–432, 433, 434, 456,
D9/457, 711, 713, 721–722
CPC ... B65D 5/00; B65D 5/02; B65D 5/18; B65D
5/20
See application file for complete search history.

(56) **References Cited**

U.S. PATENT DOCUMENTS

- 2,967,610 A 1/1961 Ebert et al.
- 3,090,483 A 5/1963 Altree et al.
- 3,158,312 A 11/1964 Daniel
- 3,215,332 A 11/1965 Bess
- 3,860,304 A 1/1975 Bolton
- 3,884,348 A * 5/1975 Ross B65D 5/48016
206/746

- 4,113,100 A * 9/1978 Soja B65D 5/5445
229/112
- 4,252,236 A 2/1981 Roccaforte
- 4,778,057 A 10/1988 Allen et al.
- 4,793,487 A 12/1988 Bentsen et al.
- 4,883,675 A 11/1989 Wernz
(Continued)

FOREIGN PATENT DOCUMENTS

- WO WO 2006/061839 A2 6/2006
- WO WO 2007/070998 A2 6/2007

OTHER PUBLICATIONS

Co-pending U.S. Appl. No. 29/634,821, filed Jan. 25, 2018, by Breen et al. for "Package."

(Continued)

Primary Examiner — Vy N Koenig

(74) *Attorney, Agent, or Firm* — Kimberly-Clark Worldwide, Inc.

(57) **CLAIM**

The ornamental design for a package, as shown and described.

DESCRIPTION

FIG. 1 is a perspective view of a package showing our new design;
 FIG. 2 is a front view of the package of FIG. 1;
 FIG. 3 is a back view of the package of FIG. 1;
 FIG. 4 is a first side view of the package of FIG. 1;
 FIG. 5 is a second side view of the package of FIG. 1;
 FIG. 6 is a top view of the package of FIG. 1; and,
 FIG. 7 is a bottom view of the package of FIG. 1.
 In the drawings, the evenly spaced broken lines represent environmental structure and form no part of the claimed design; the dash-dot-dot-dash broken lines represent boundaries of the claimed design and form no part of the claimed design.

1 Claim, 6 Drawing Sheets

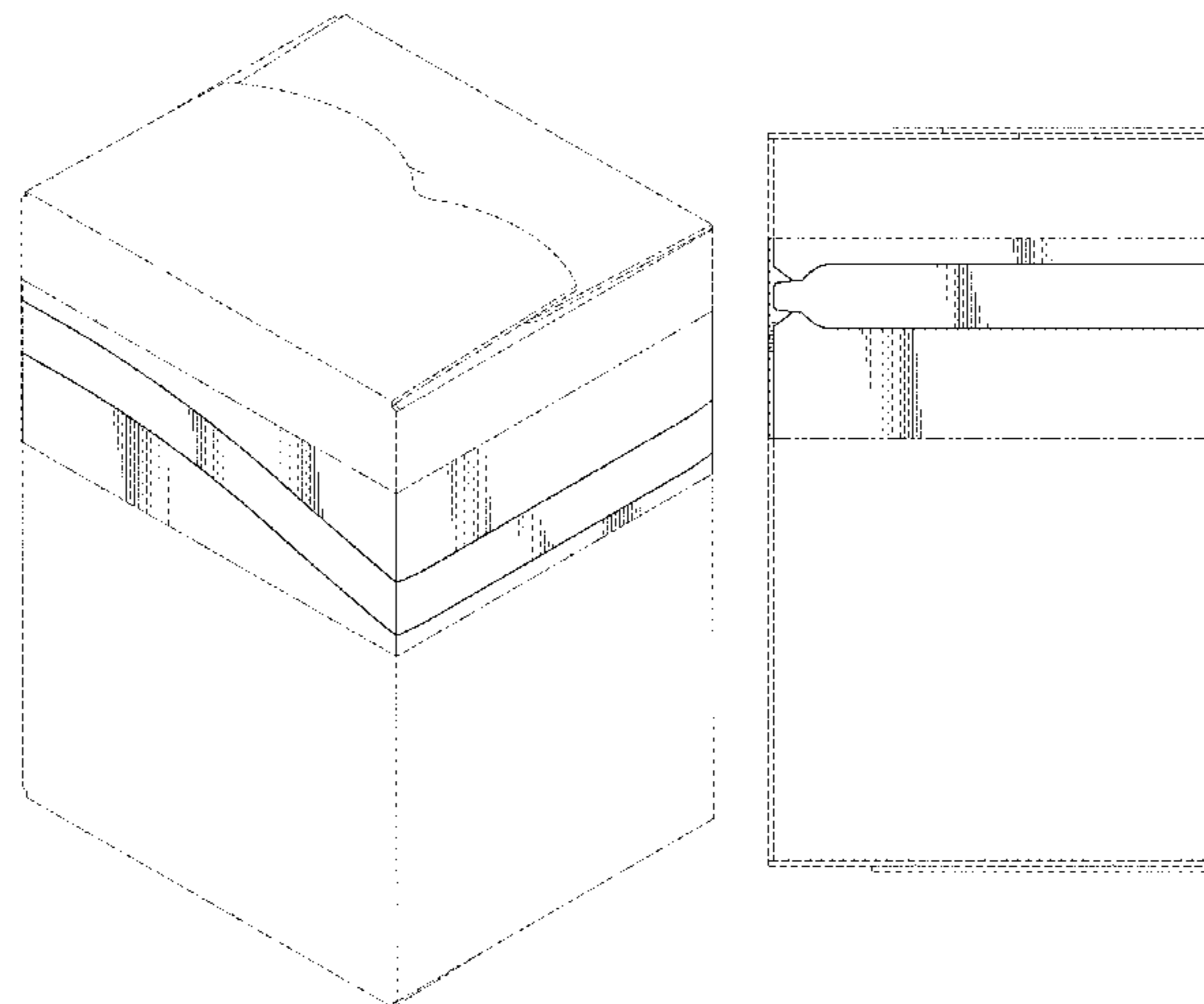

(56)

References Cited

U.S. PATENT DOCUMENTS

4,905,837 A * 3/1990 Schuster B65D 5/5475
 229/120.011

4,964,526 A 10/1990 Stephens

5,318,223 A 6/1994 Gale

5,361,905 A 11/1994 McQueeney et al.

5,533,667 A 7/1996 Gale

6,799,695 B1 10/2004 Borrero

D567,080 S 4/2008 Bone et al.

7,373,765 B2 5/2008 Welchel et al.

7,377,384 B2 5/2008 Mitten et al.

D586,210 S 2/2009 Noschang et al.

D600,548 S 9/2009 Seol et al.

D603,700 S 11/2009 Paredes et al.

D614,025 S 4/2010 Paredes et al.

7,913,845 B2 3/2011 Velazquez et al.

7,958,994 B2 6/2011 Weinmann

D655,156 S 3/2012 Schrimpf et al.

D669,793 S * 10/2012 Hynes D9/434

D672,646 S 12/2012 Vanden Boom et al.

D677,580 S * 3/2013 Powers D9/434

D680,428 S 4/2013 Vanden Boom et al.

D685,262 S 7/2013 Hunter

D692,311 S 10/2013 Wilcoxon et al.

D693,681 S 11/2013 Allen et al.

D701,118 S 3/2014 Klopp et al.

D705,056 S 5/2014 Gagliardo et al.

D706,629 S 6/2014 Bartels et al.

D711,737 S 8/2014 Hara et al.

D712,736 S * 9/2014 Hara D9/432

D715,142 S 10/2014 Allen et al.

D732,952 S 6/2015 Ghini et al.

D752,439 S * 3/2016 Abel D9/499

D774,400 S * 12/2016 Miyazaki D9/434

D775,964 S * 1/2017 Mochizuki D9/432

D778,167 S * 2/2017 Mochizuki D9/432

D785,452 S 5/2017 Lee et al.

D800,573 S * 10/2017 Mochizuki D9/624

D811,876 S * 3/2018 Breen D9/432

D812,466 S * 3/2018 Janes D9/432

2003/0130632 A1 7/2003 Costea et al.

2008/0190791 A1 8/2008 Ghini et al.

2009/0108010 A1 4/2009 Ludden-Biegel

2011/0095021 A1 4/2011 Clough

OTHER PUBLICATIONS

Co-pending U.S. Appl. No. 29/634,822, filed Jan. 25, 2018, by Breen et al. for "Package."

Co-pending U.S. Appl. No. 29/634,823, filed Jan. 25, 2018, by Breen et al. for "Package."

Co-pending U.S. Appl. No. 29/634,831, filed Jan. 25, 2018, by Janes et al. for "Package."

Co-pending U.S. Appl. No. 29/634,838, filed Jan. 25, 2018, by Janes et al. for "Package."

* cited by examiner

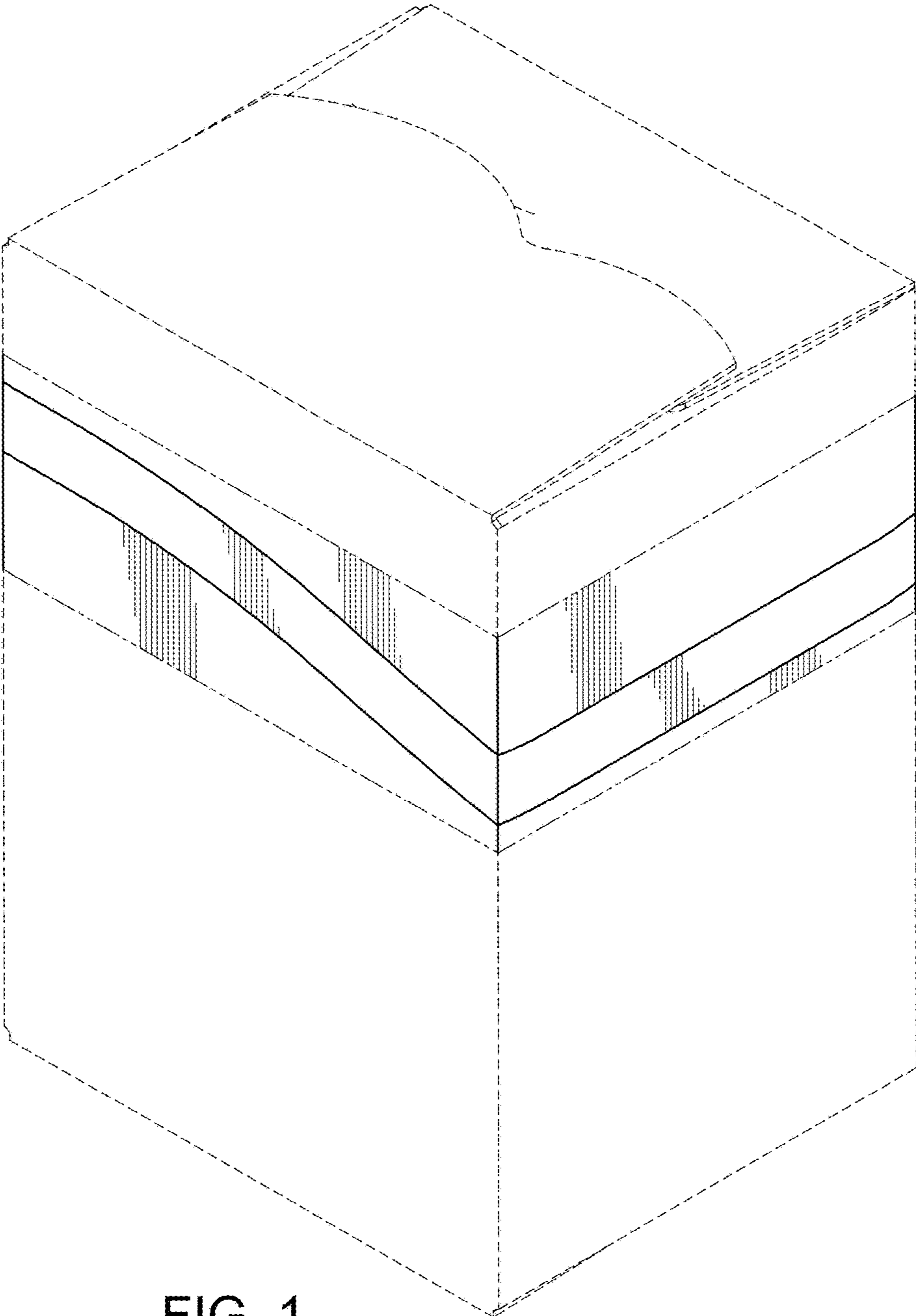

FIG. 1

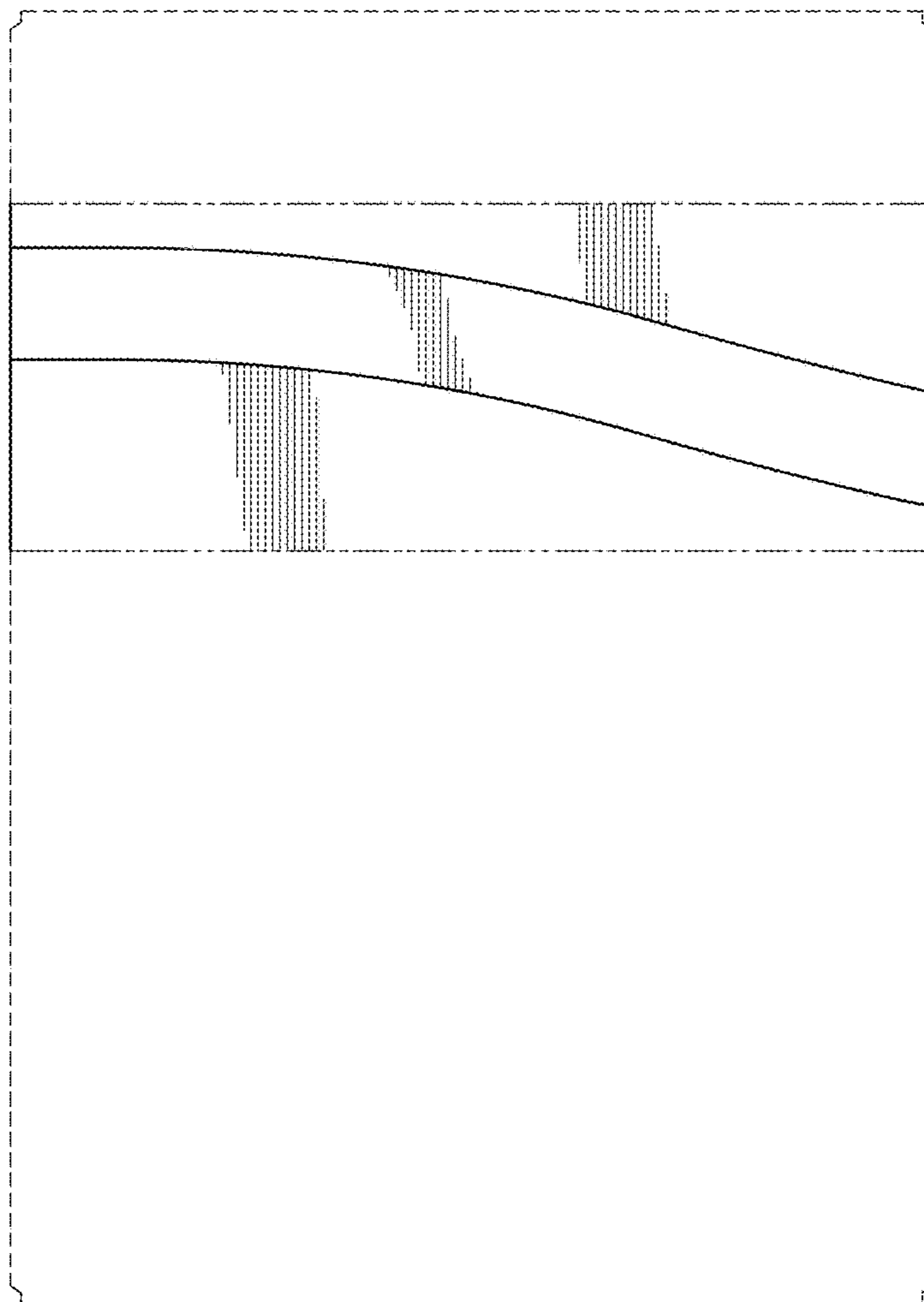

FIG. 2

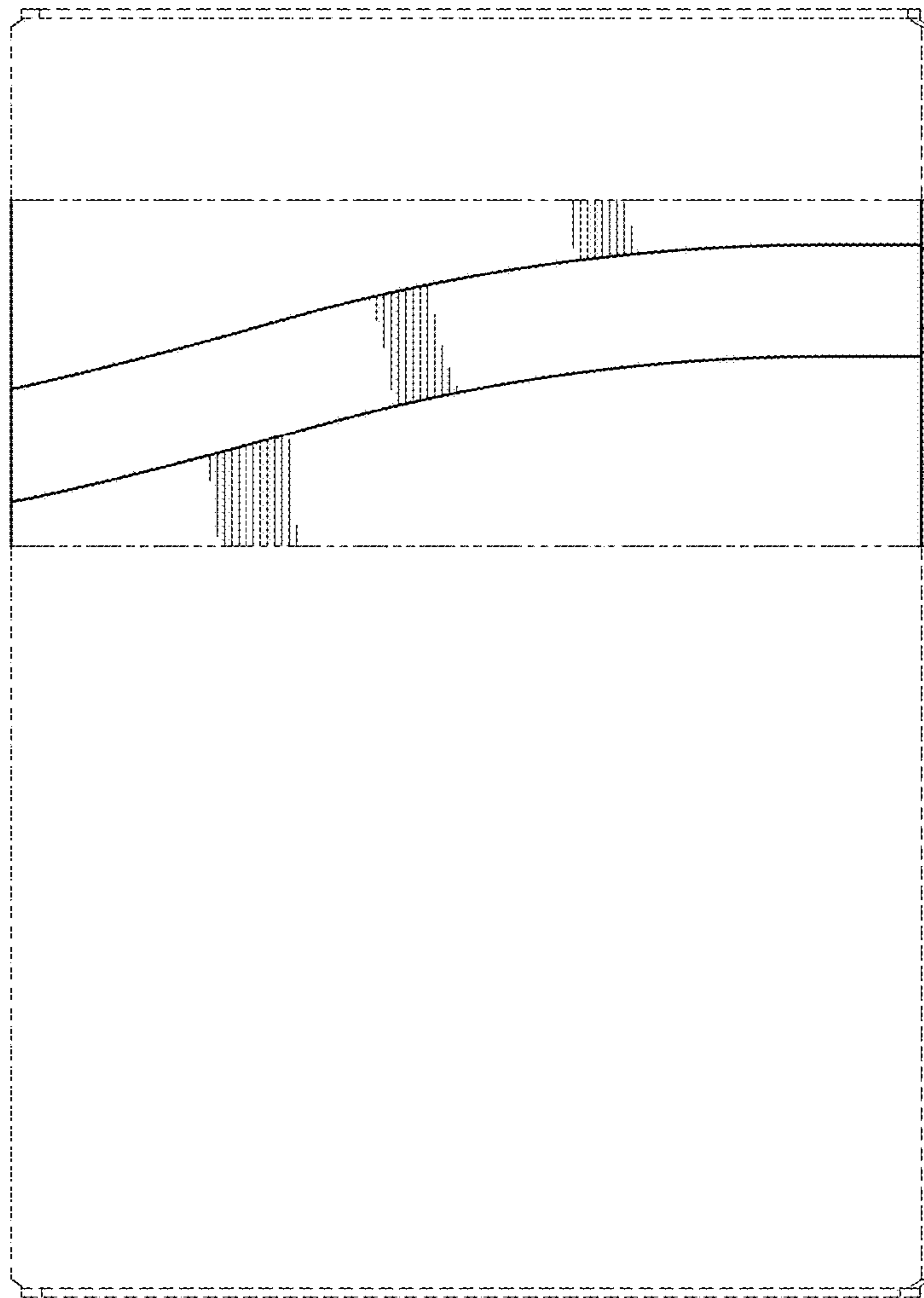

FIG. 3

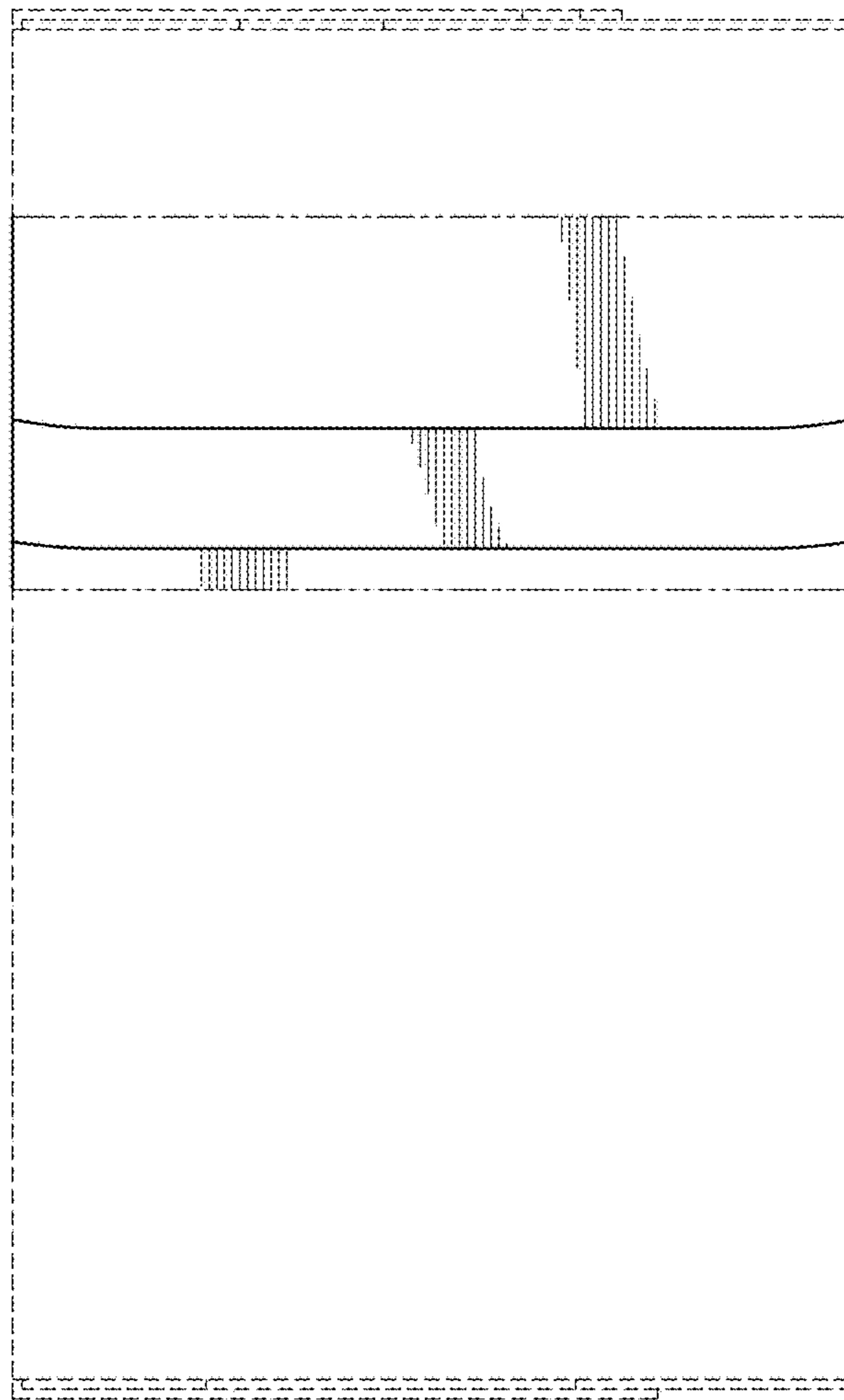

FIG. 4

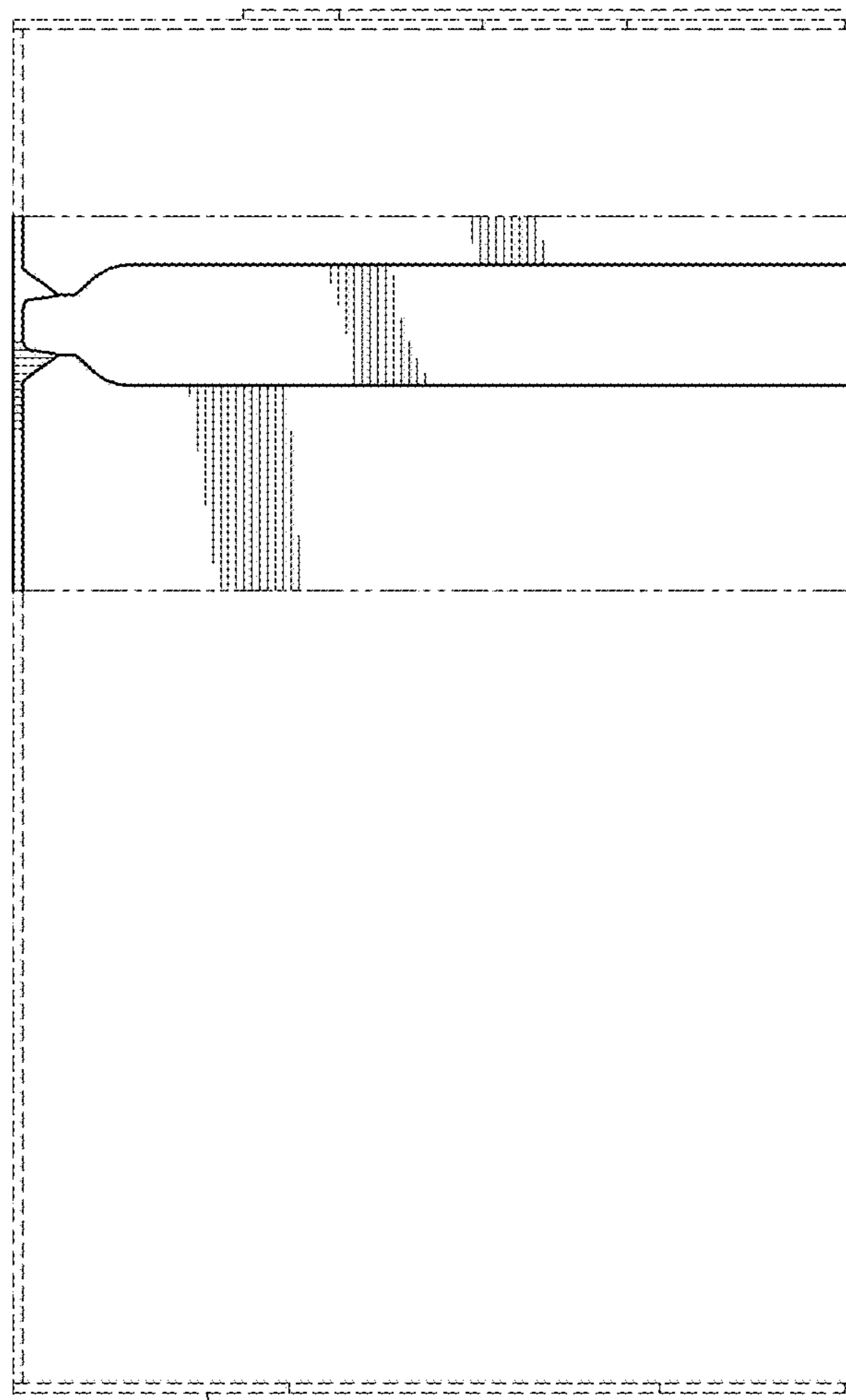

FIG. 5

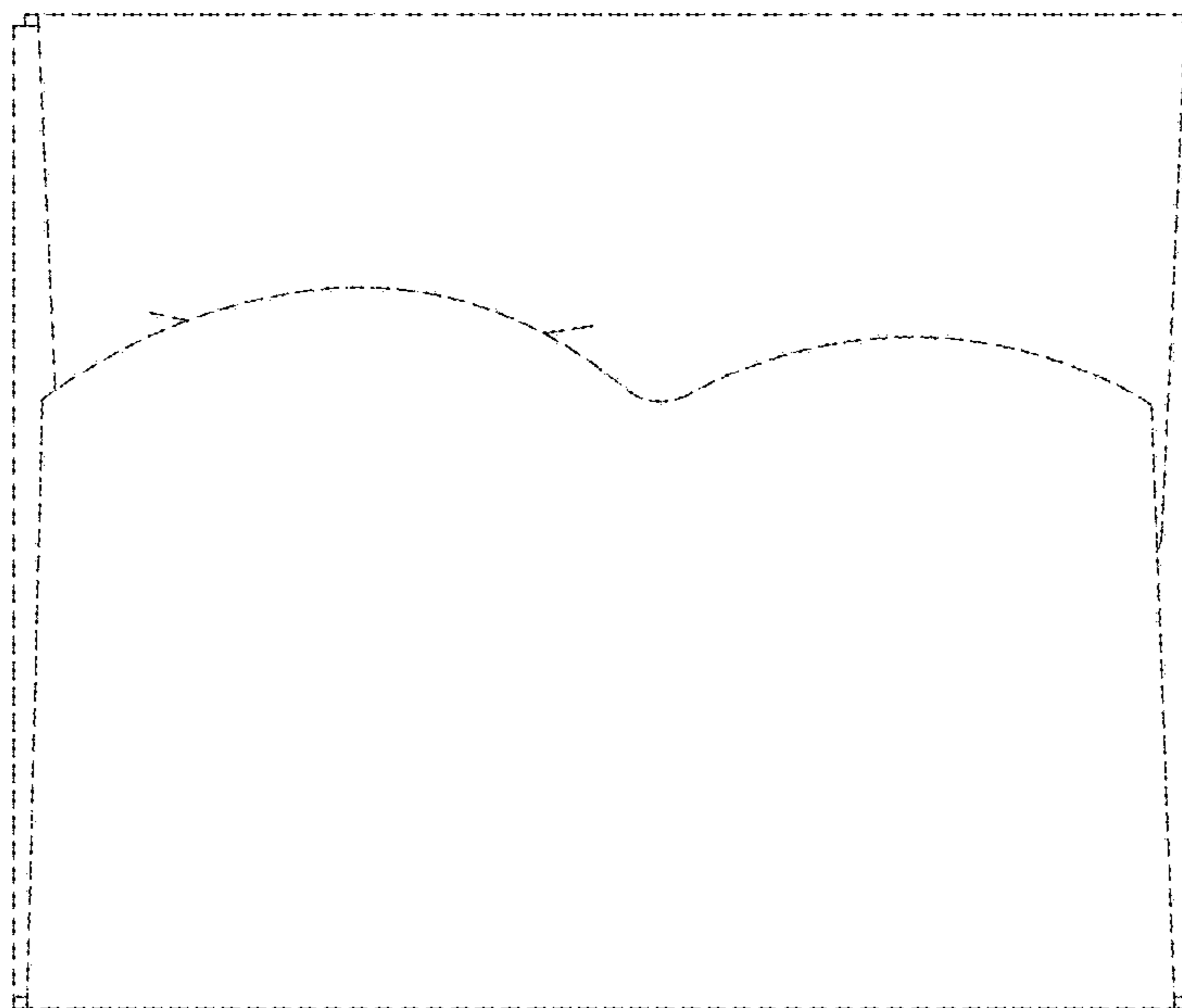

FIG. 6

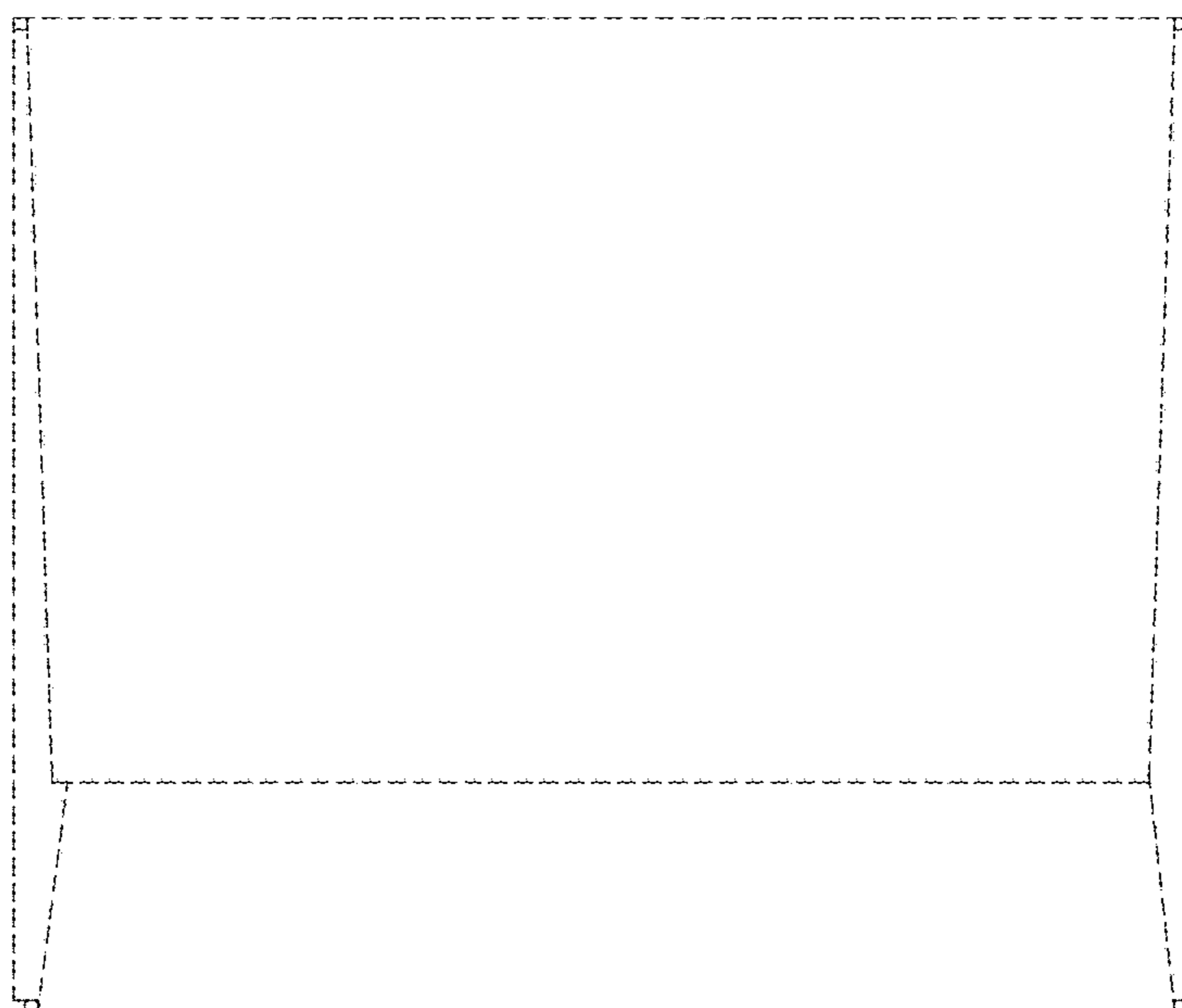

FIG. 7