



US00D842621S

(12) **United States Design Patent**
Snyder

(10) **Patent No.:** **US D842,621 S**
(45) **Date of Patent:** **** Mar. 12, 2019**

- (54) **GOLF CLUB ORGANIZER**
- (71) Applicant: **Bruce A. Snyder**, Seneca, SC (US)
- (72) Inventor: **Bruce A. Snyder**, Seneca, SC (US)
- (**) Term: **15 Years**
- (21) Appl. No.: **29/574,367**
- (22) Filed: **Aug. 15, 2016**
- (51) **LOC (11) Cl.** **06-04**
- (52) **U.S. Cl.**
USPC **D6/552**
- (58) **Field of Classification Search**
USPC D6/552; D3/319, 320, 328.1; 211/1.53,
211/85.7, 163; 473/282
CPC A63B 55/00; A63B 55/10
See application file for complete search history.

- (56) **References Cited**
U.S. PATENT DOCUMENTS

663,838 A * 12/1900 White A47F 5/02
211/70
712,428 A * 10/1902 Whitcomb A47B 81/005
211/64
D211,295 S * 6/1968 Wolf D19/85
D263,780 S * 4/1982 Hildebrand D6/552
5,137,319 A * 8/1992 Sauder A01K 97/10
206/315.11
D341,276 S * 11/1993 Jones D6/552
D393,391 S * 4/1998 Lorenz D6/552
D477,487 S * 7/2003 Chaney D6/552
6,938,766 B1 * 9/2005 Lee A47F 5/02
206/388

- 2001/0054595 A1* 12/2001 Cabrera A47B 81/005
211/70.2
 - 2003/0015486 A1* 1/2003 Chen A47F 5/02
211/70
 - 2004/0016711 A1* 1/2004 Burrows A47F 7/0021
211/70.2
 - 2018/0028884 A1* 2/2018 Snyder A63B 55/10
- * cited by examiner

Primary Examiner — R. Johnson
(74) *Attorney, Agent, or Firm* — The Van Winkle Law Firm; William G. Heedy; David M. Carter

(57) **CLAIM**
The ornamental design for a golf club organizer, as shown and described.

DESCRIPTION

FIG. 1 is a perspective view of a golf club organizer showing my new design.
FIG. 2 is a front elevational view thereof.
FIG. 3 is a rear elevational view thereof.
FIG. 4 is a left side elevational view thereof.
FIG. 5 is a right side elevational view thereof.
FIG. 6 is a top plan view thereof.
FIG. 7 is a bottom plan view thereof; and,
FIG. 8 is a perspective view thereof.
The broken lines in FIGS. 1, 6 and 8 represent the portions of the design that form no part of the claim. The broken lines of FIG. 8, showing golf clubs stored on the golf club organizer, illustrate the design in use and form no part of the claim.

1 Claim, 7 Drawing Sheets

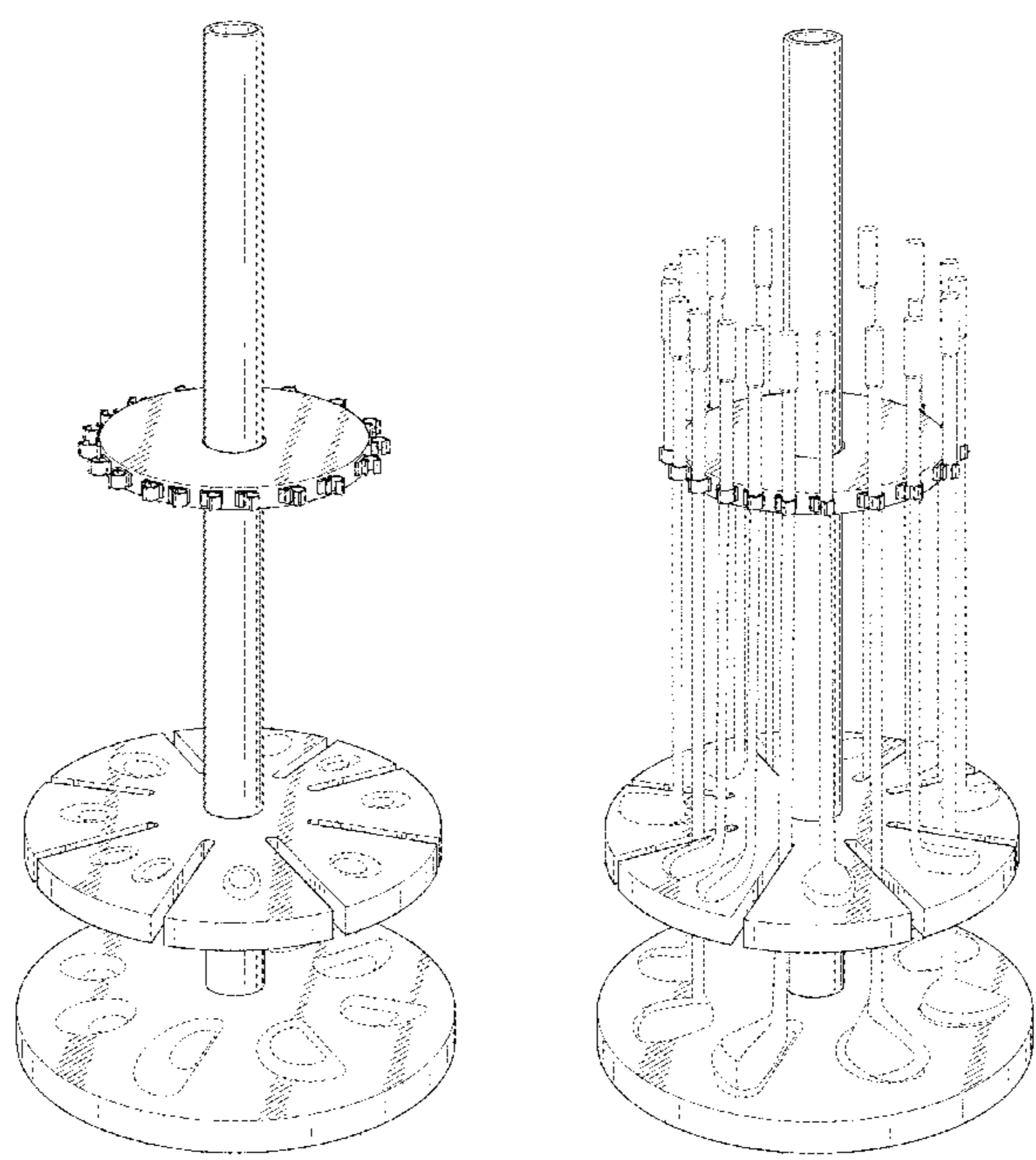

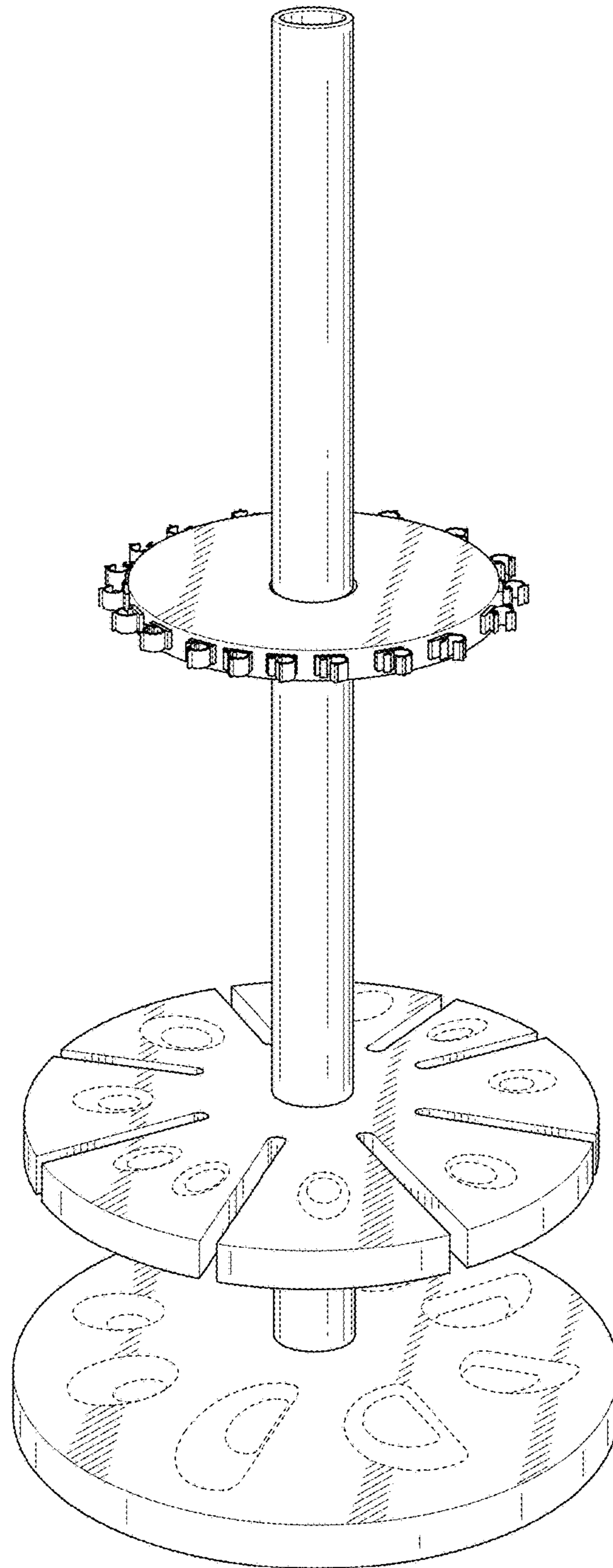

FIG. 1

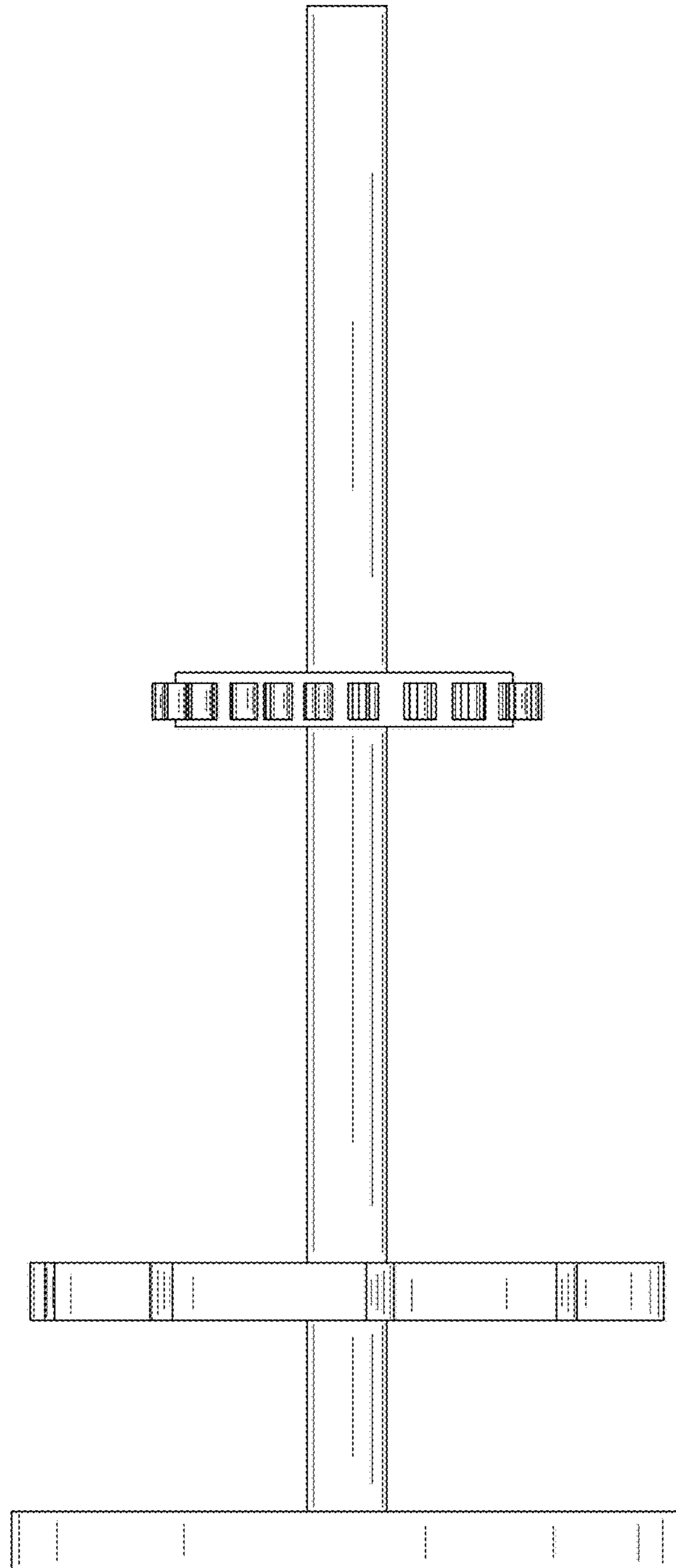

FIG. 2

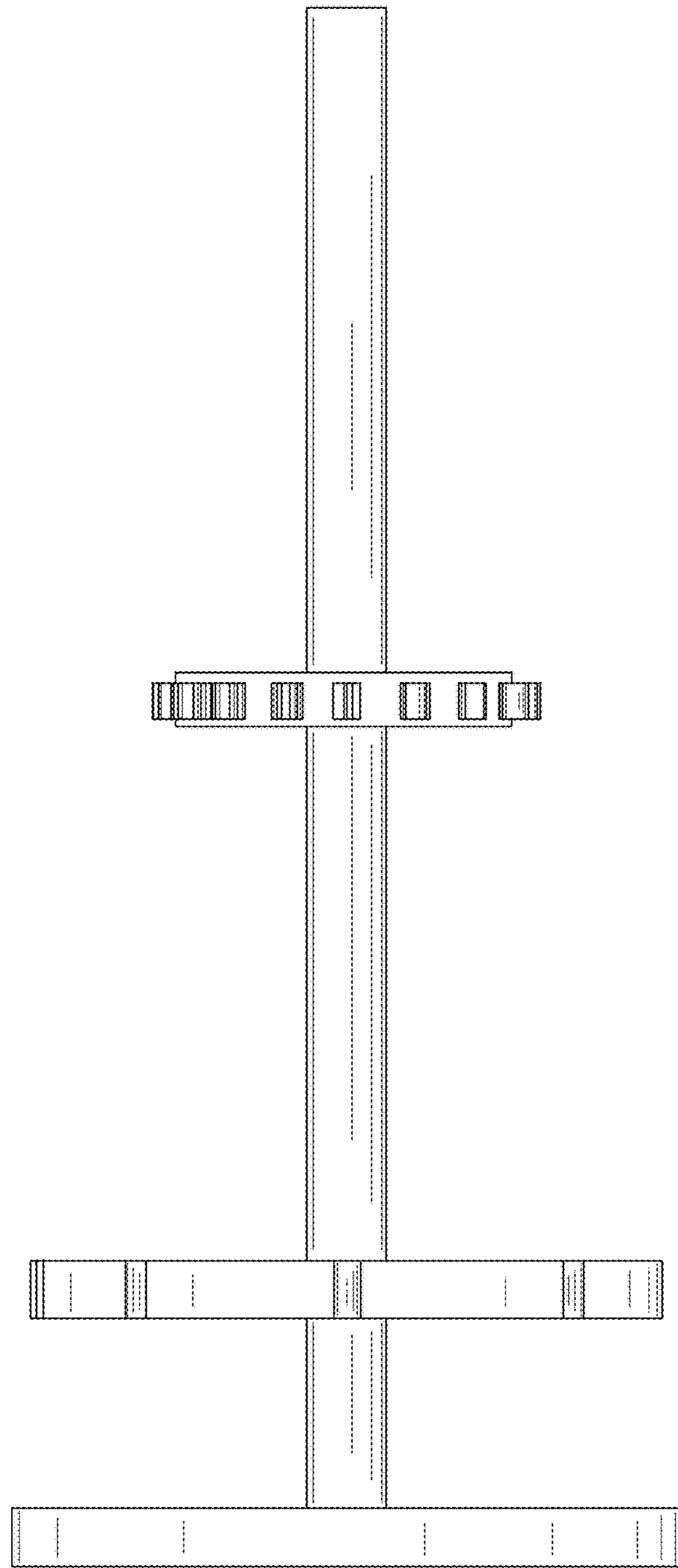

FIG. 3

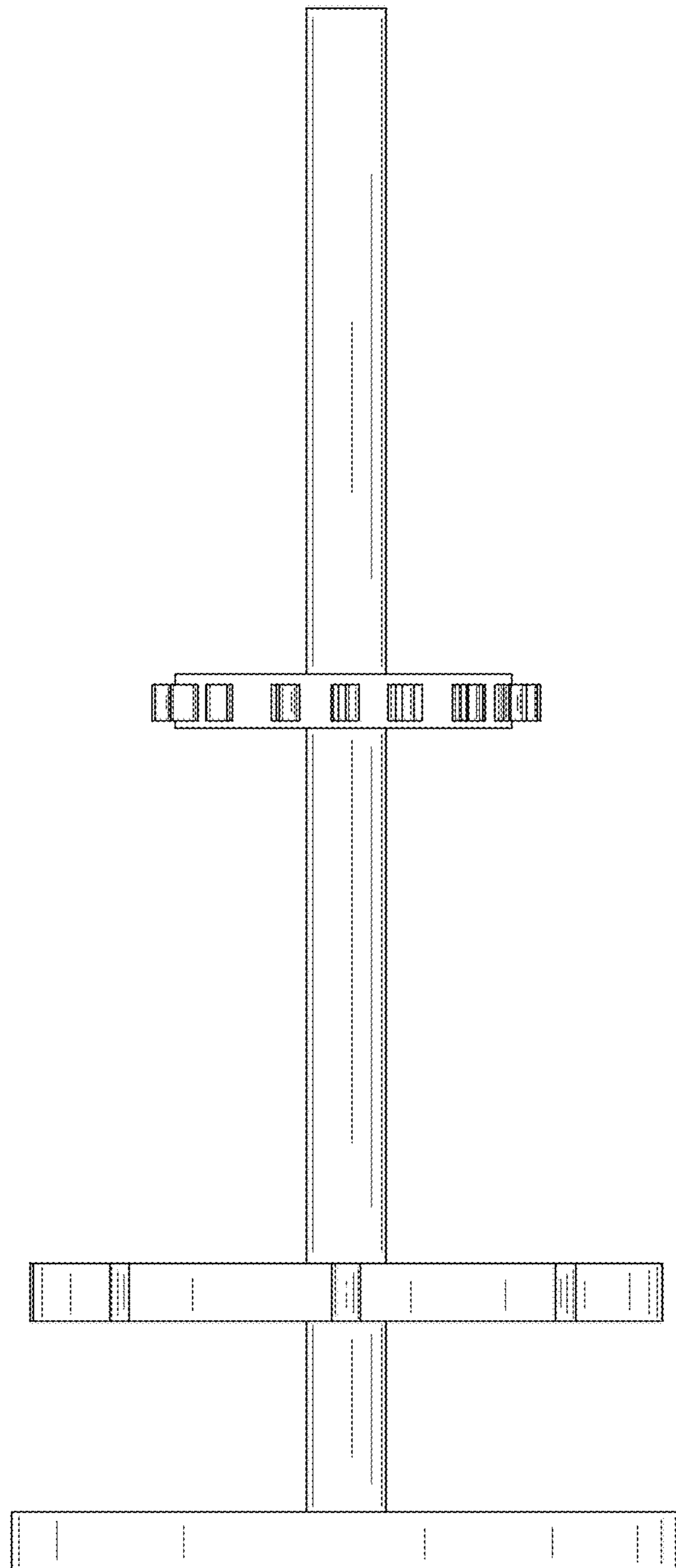

FIG. 4

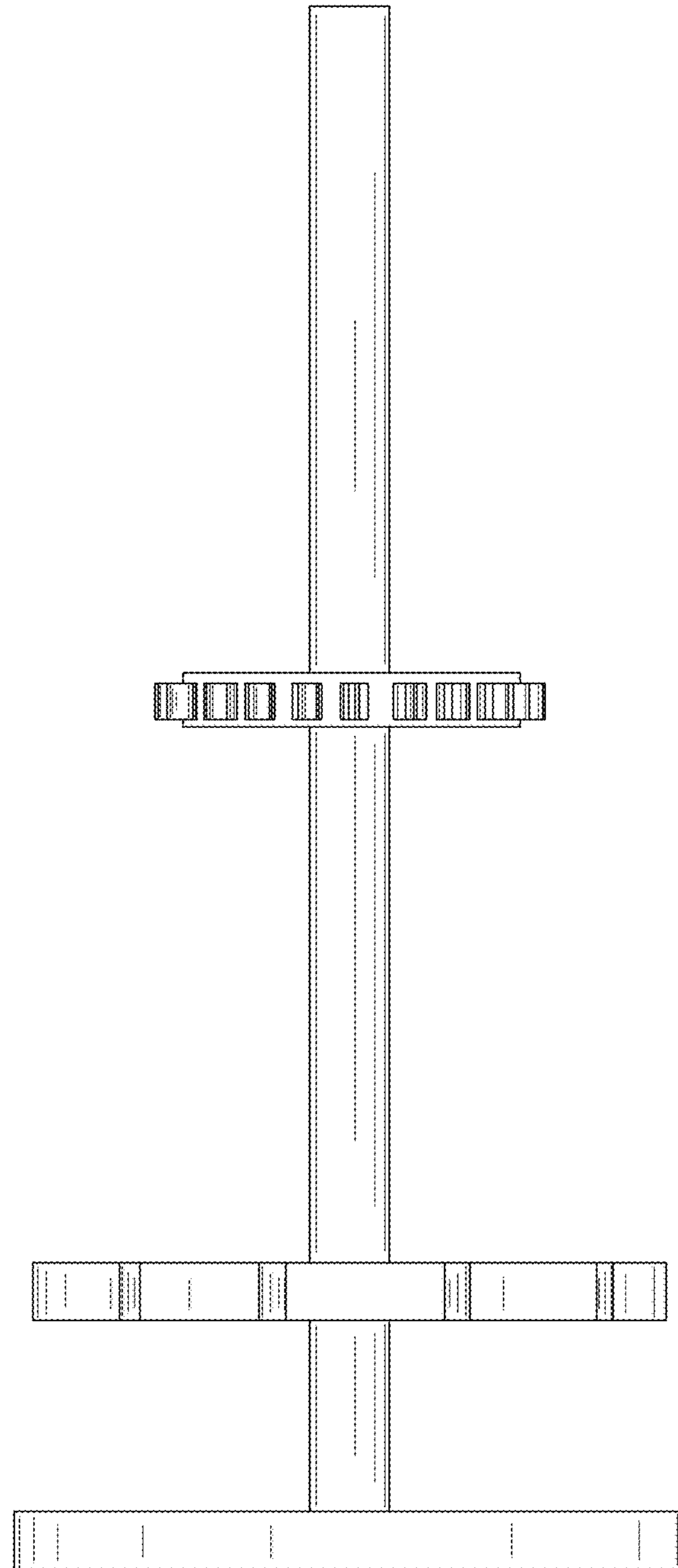

FIG. 5

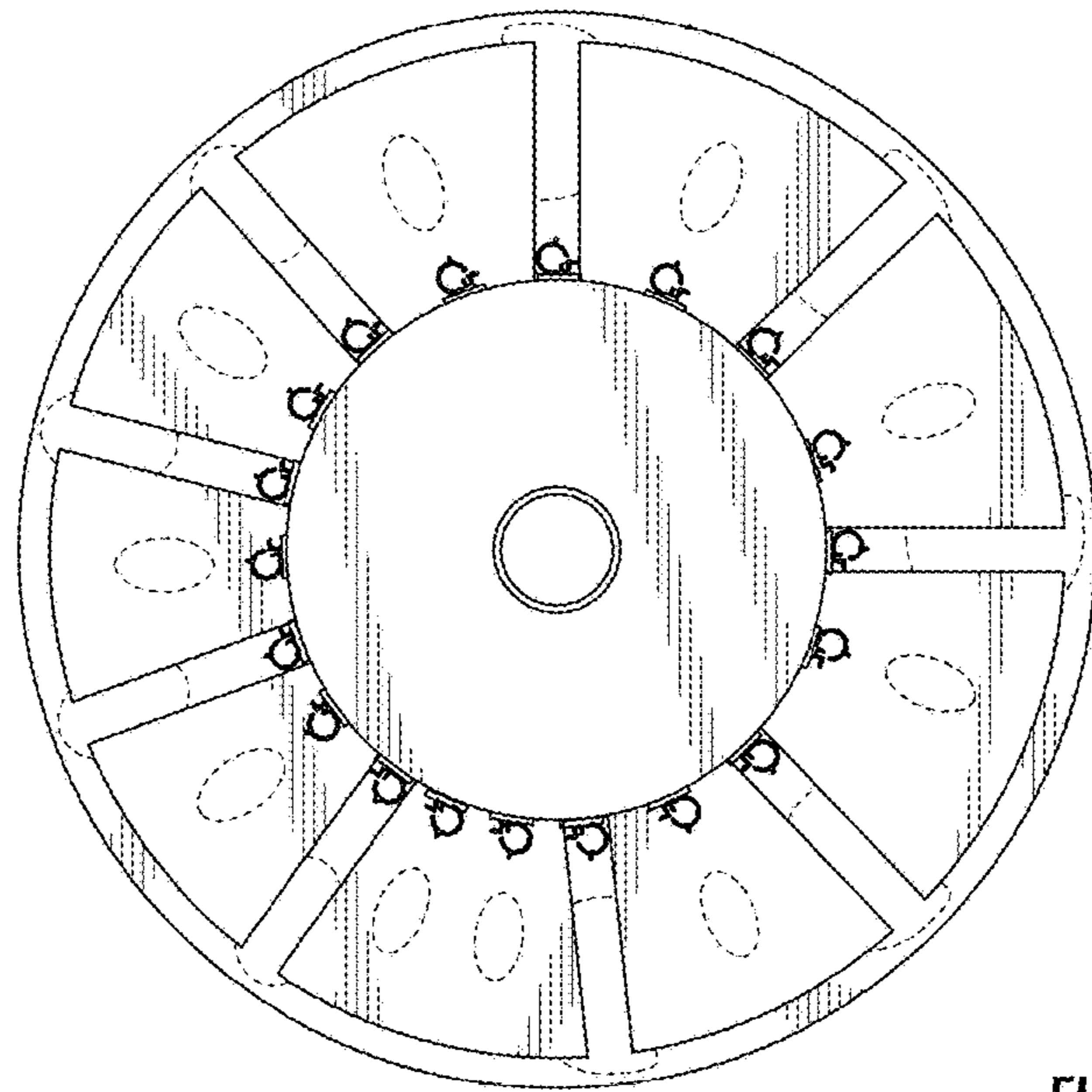

FIG. 6

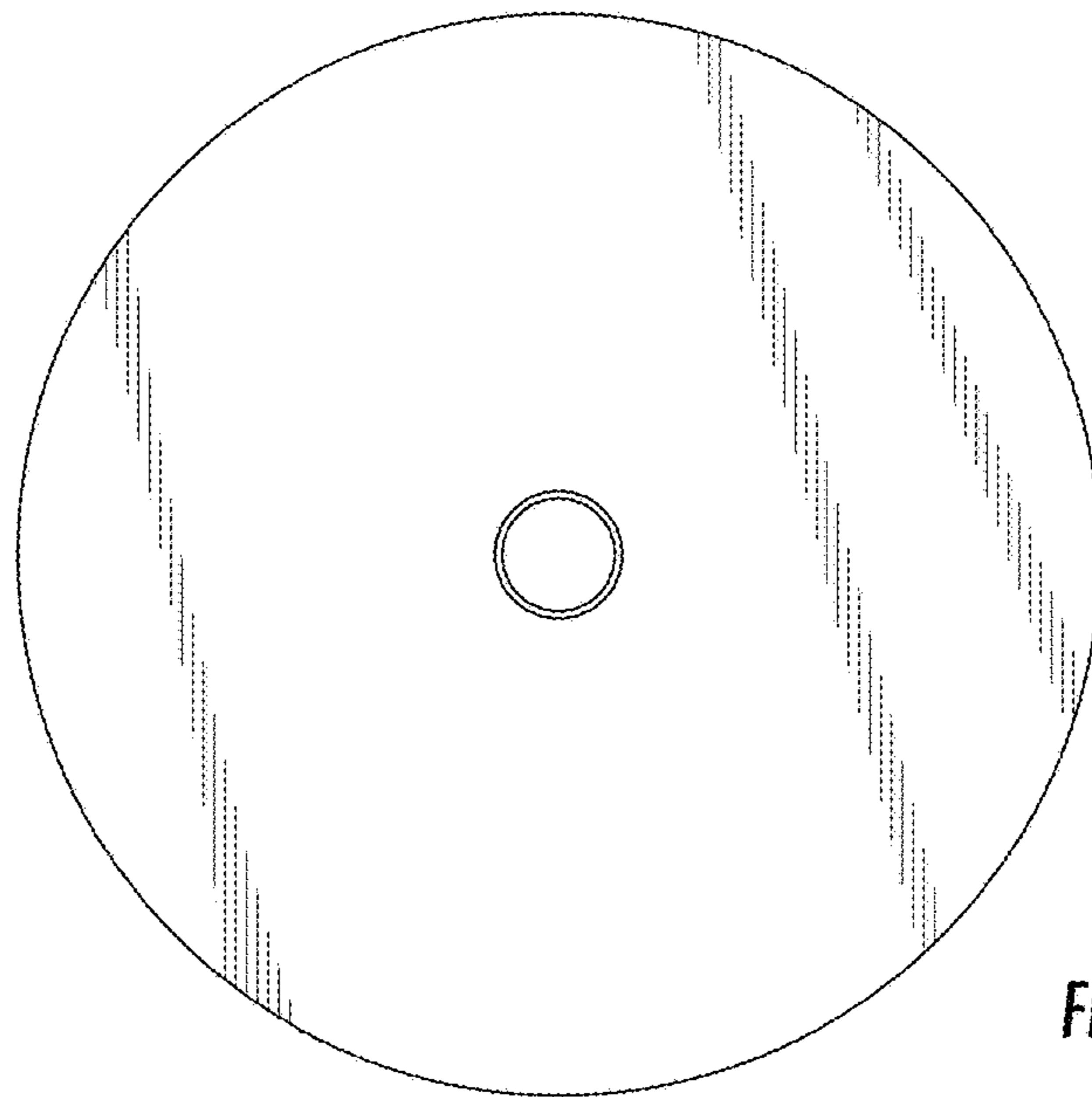

FIG. 7

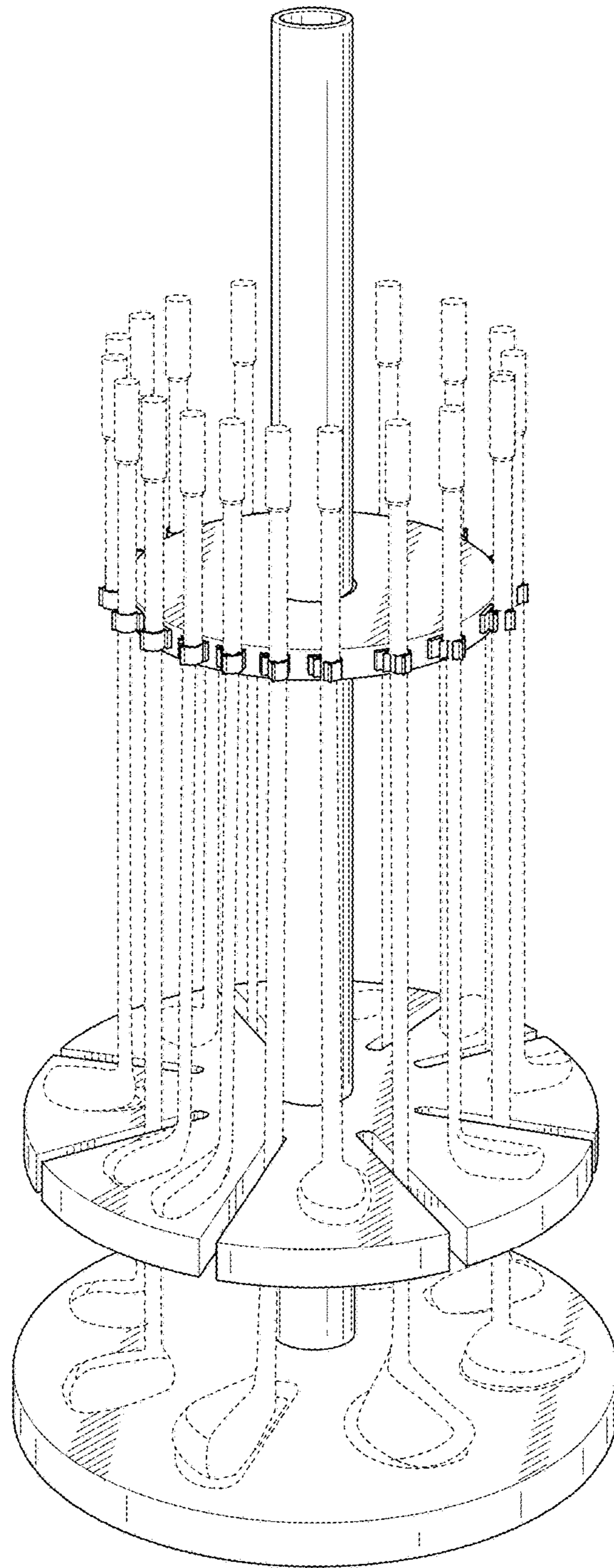

FIG. 8