



US00D842432S

(12) **United States Design Patent**
Chen et al.

(10) **Patent No.:** **US D842,432 S**
(45) **Date of Patent:** **** Mar. 5, 2019**

(54) **SHOWER HEAD**

(71) Applicant: **XIAMEN SOLEX HIGH-TECH INDUSTRIES CO., LTD.**, Xiamen, Fujian (CN)

(72) Inventors: **Yiying Chen**, Fujian (CN); **Lianlian Tian**, Fujian (CN); **Xian Lin**, Fujian (CN)

(73) Assignee: **XIAMEN SOLEX HIGH-TECH INDUSTRIES CO., LTD.**, Xiamen (CN)

(**) Term: **15 Years**

(21) Appl. No.: **29/625,290**

(22) Filed: **Nov. 8, 2017**

(51) **LOC (11) Cl.** **23-01**

(52) **U.S. Cl.**
USPC **D23/229**

(58) **Field of Classification Search**
USPC D23/213, 229, 230, 255, 257; 137/801;
4/678
CPC A47K 7/00; B05B 1/00; B05B 1/05; B05B
1/18; B05B 1/185; B05B 1/14; B05B
1/02

See application file for complete search history.

(56) **References Cited**

U.S. PATENT DOCUMENTS

D674,465 S *	1/2013	Flowers	B05B 1/1627 D23/229
D674,466 S *	1/2013	Flowers	B05B 1/18 D23/229
D754,815 S *	4/2016	Zou	B01D 35/02 D23/229
9,504,940 B2 *	11/2016	Farley	B01D 35/02
9,849,471 B2 *	12/2017	Lin	B05B 1/1627
10,046,340 B2 *	8/2018	Lin	B05B 1/18

* cited by examiner

Primary Examiner — Robin V Webster

(74) *Attorney, Agent, or Firm* — Rabin & Berdo, P.C.

(57) **CLAIM**

The ornamental design for a shower head, as shown.

DESCRIPTION

FIG. 1. is a front view of a shower head showing our new design thereof;

FIG. 2. is a rear view thereof,

FIG. 3. is a left side view thereof,

FIG. 4. is a right side view thereof,

FIG. 5. is a top plan view thereof,

FIG. 6. is a bottom plan view thereof; and,

FIG. 7. is a perspective view thereof.

1 Claim, 7 Drawing Sheets

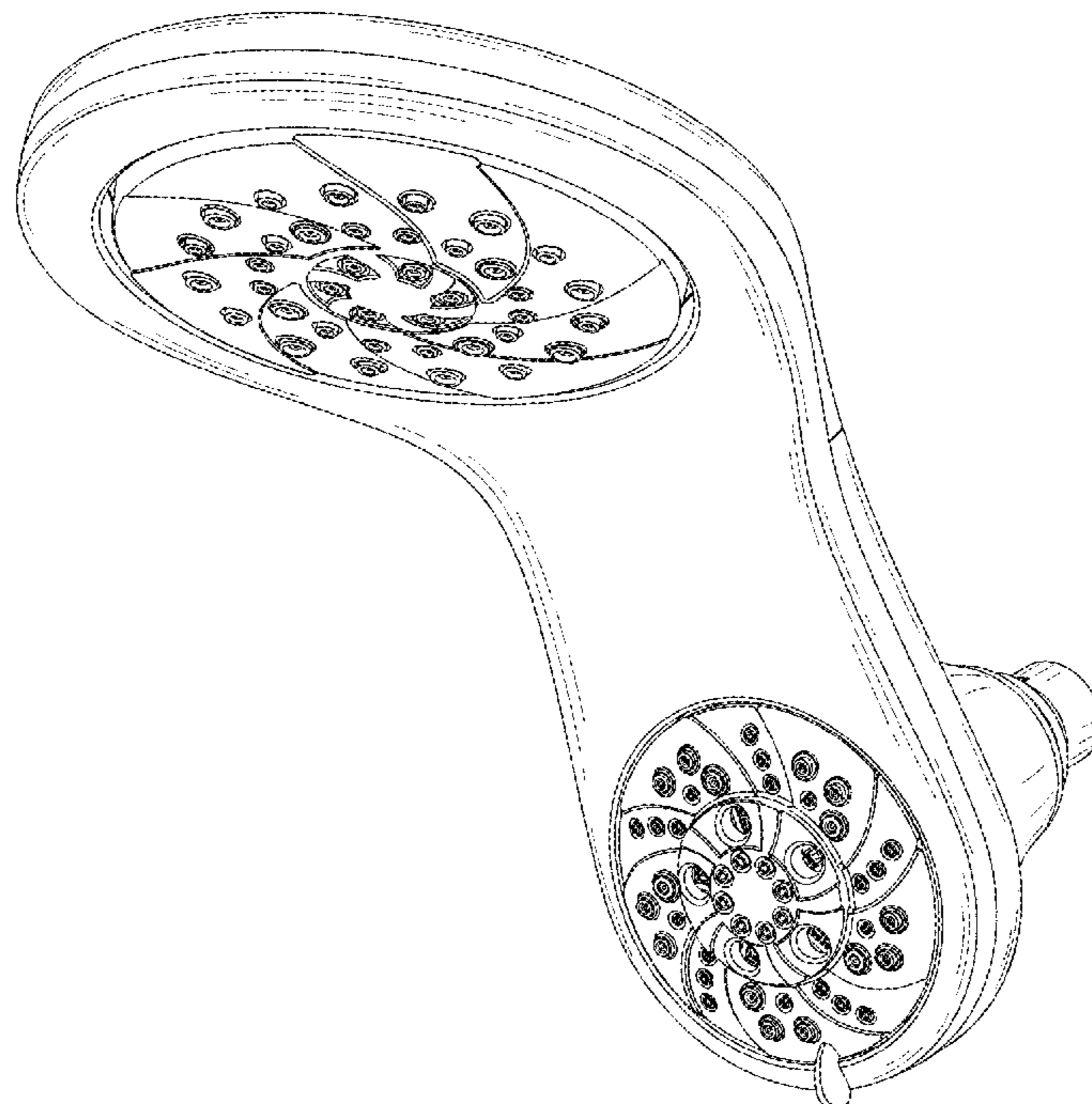

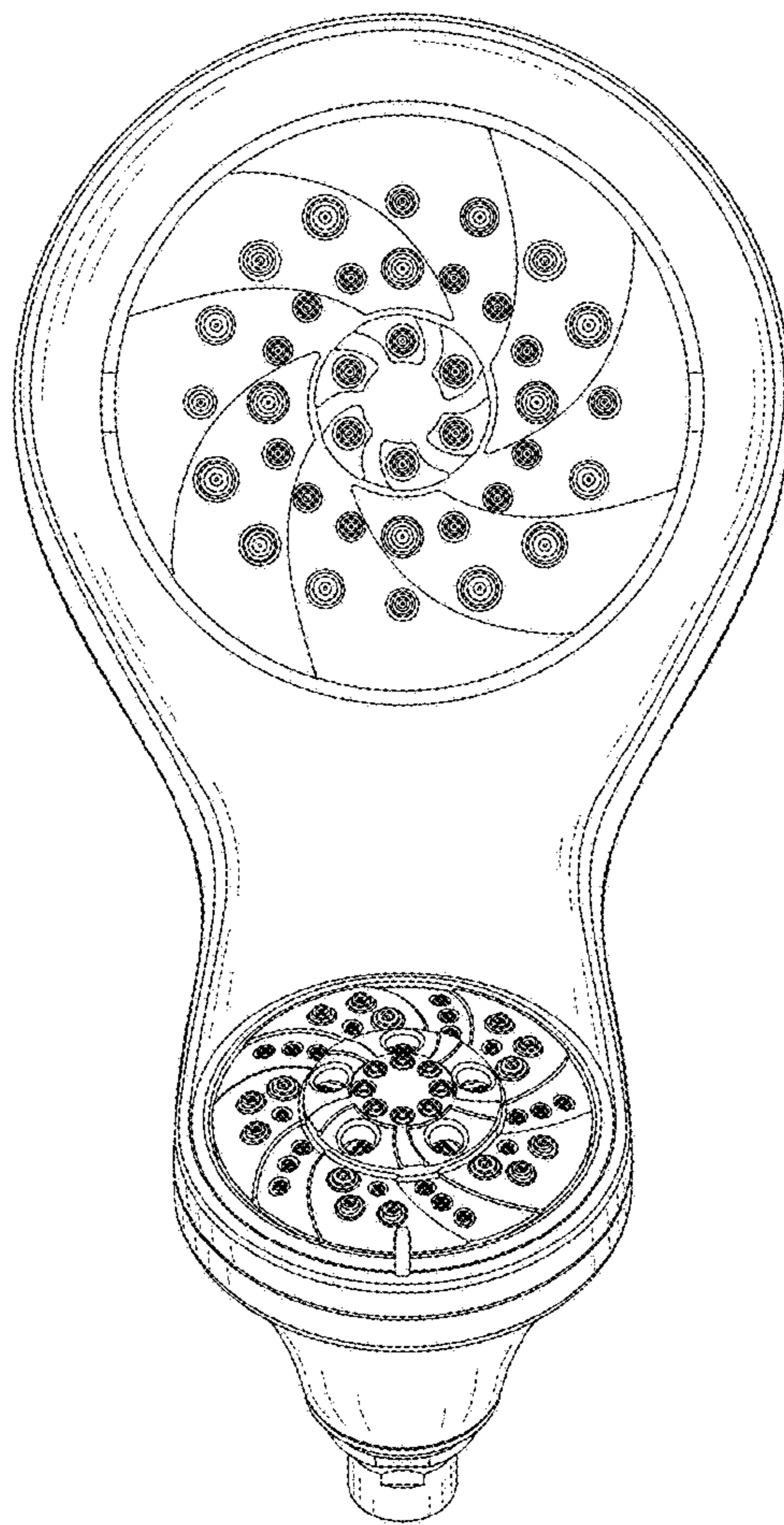

Fig. 1

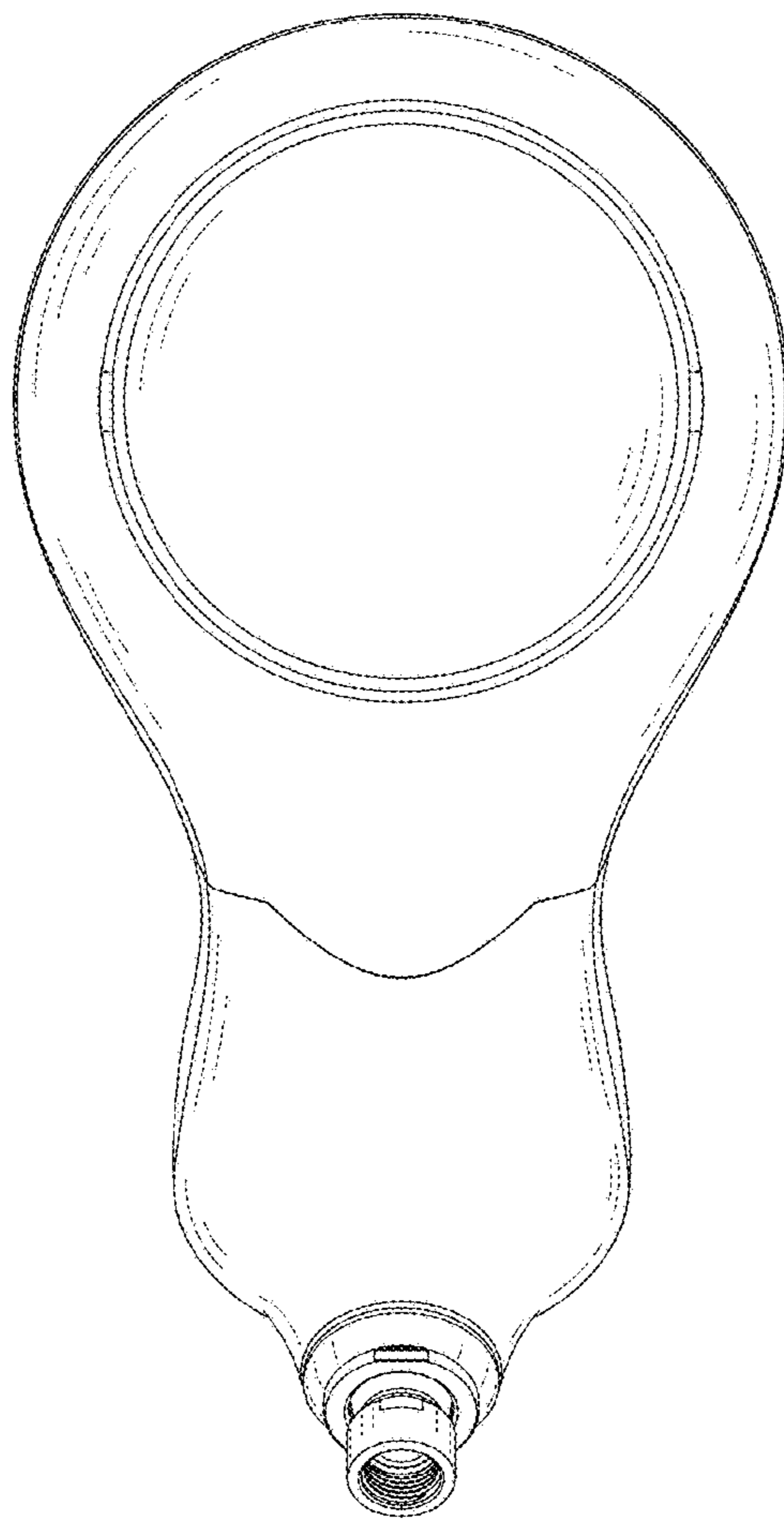

Fig. 2

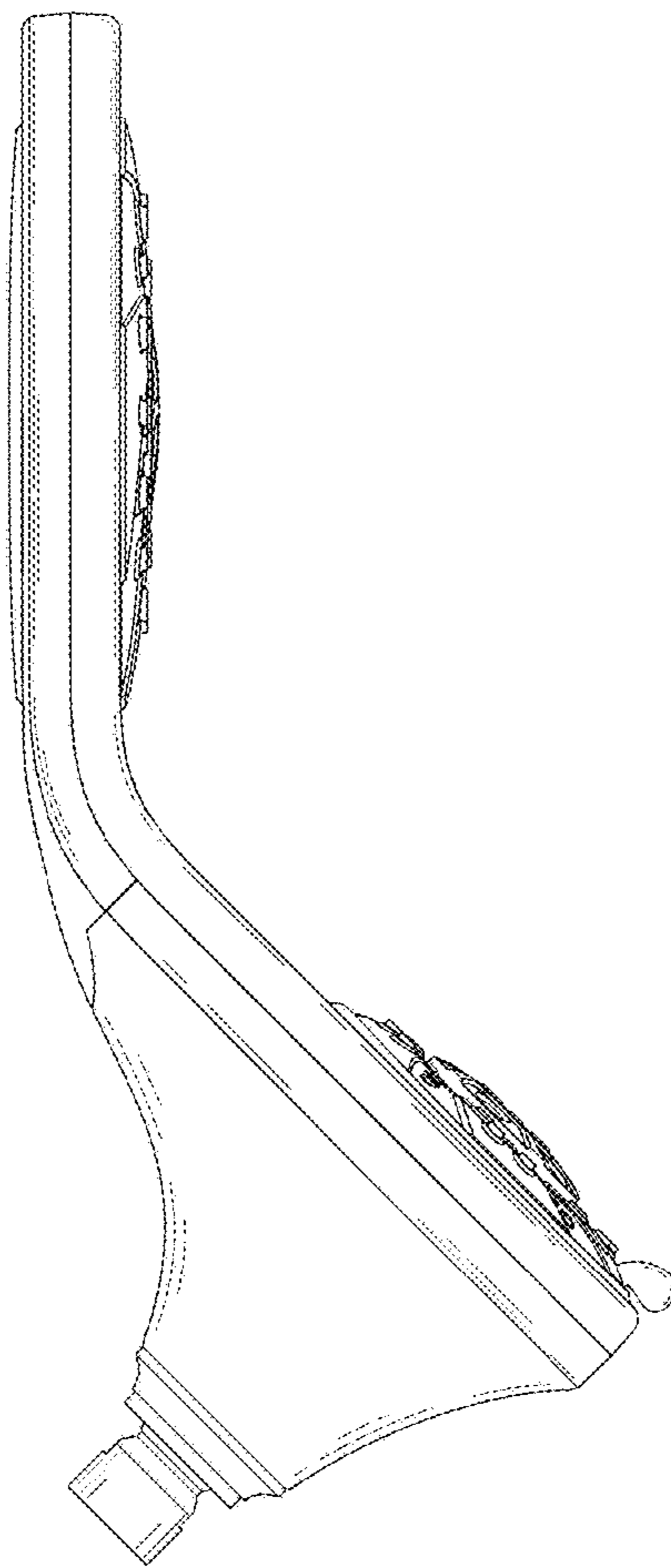

Fig. 3

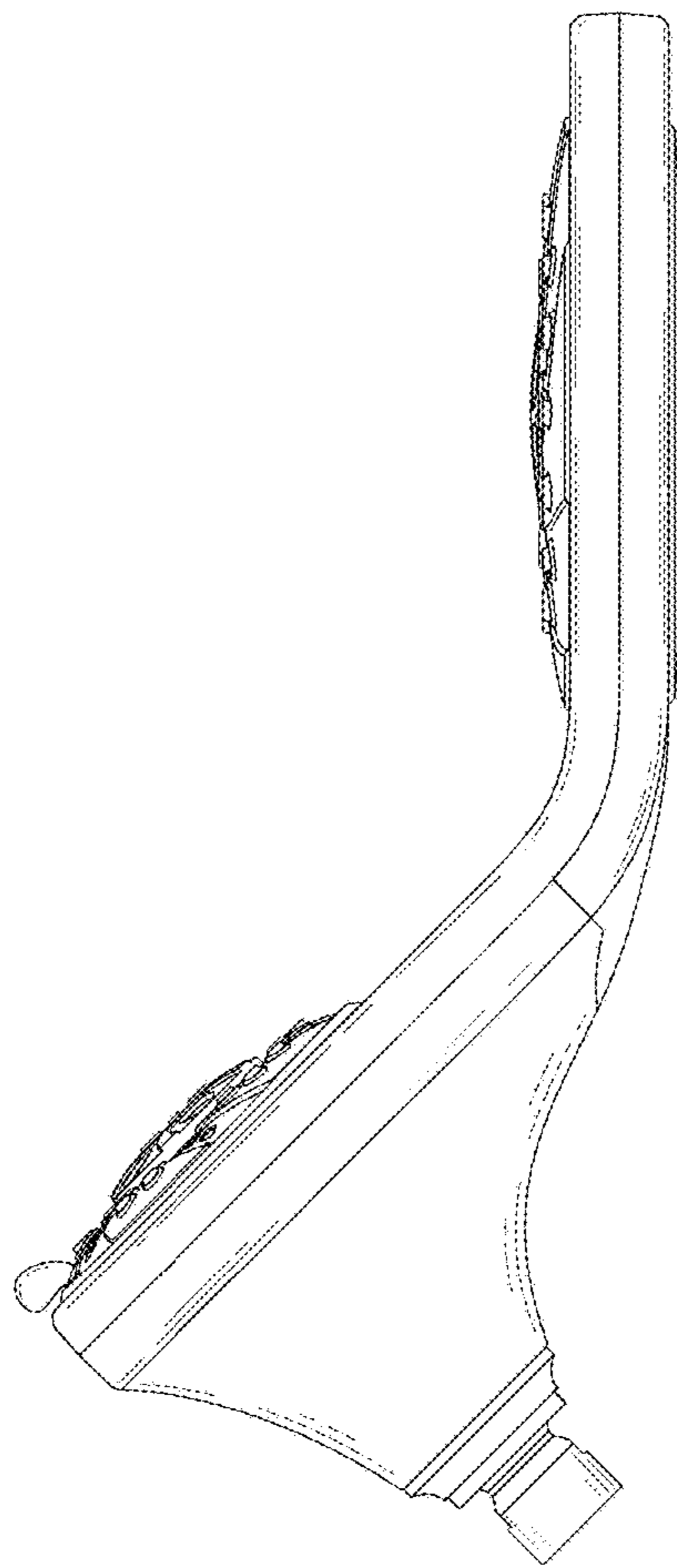

Fig. 4

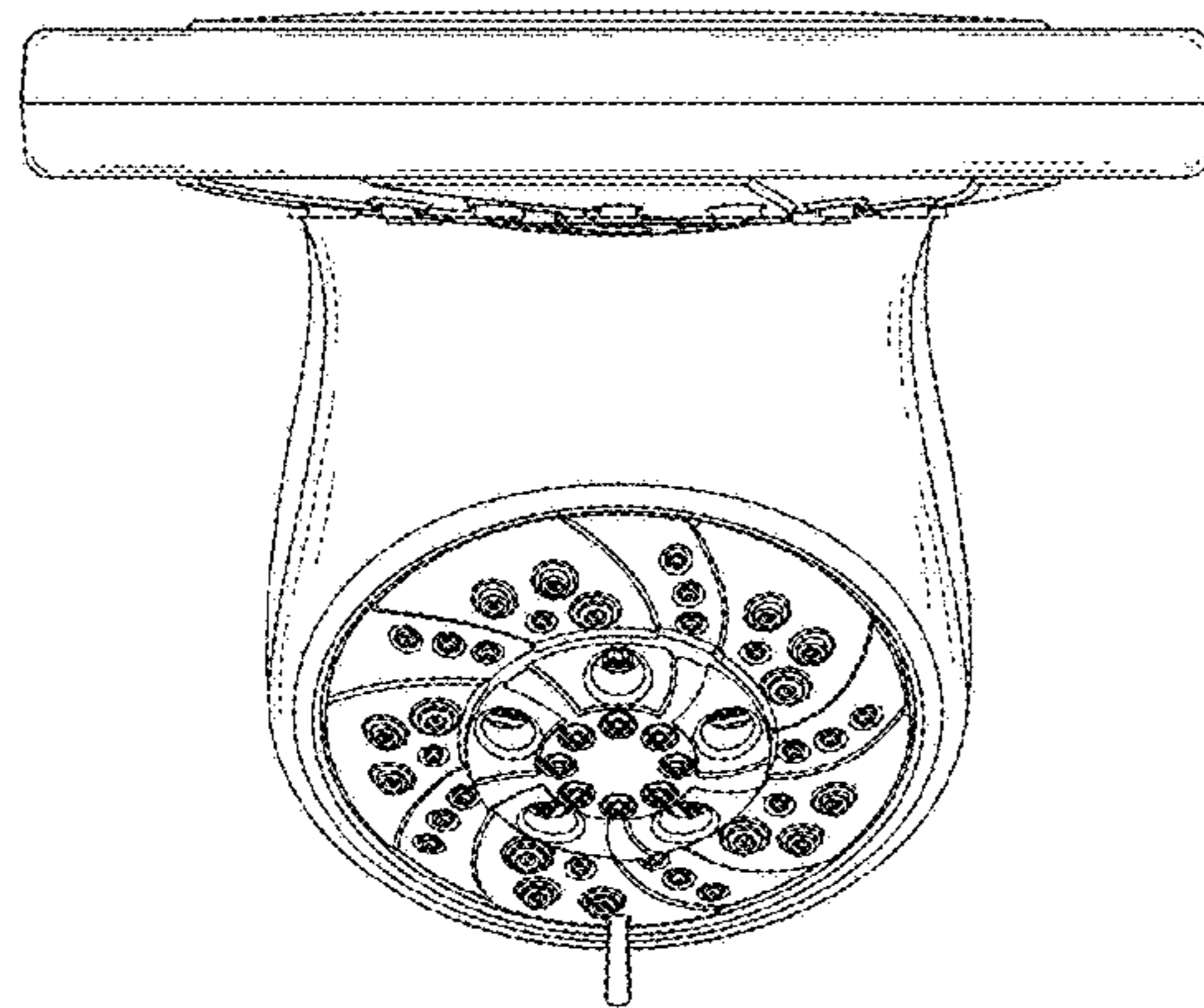

Fig. 5

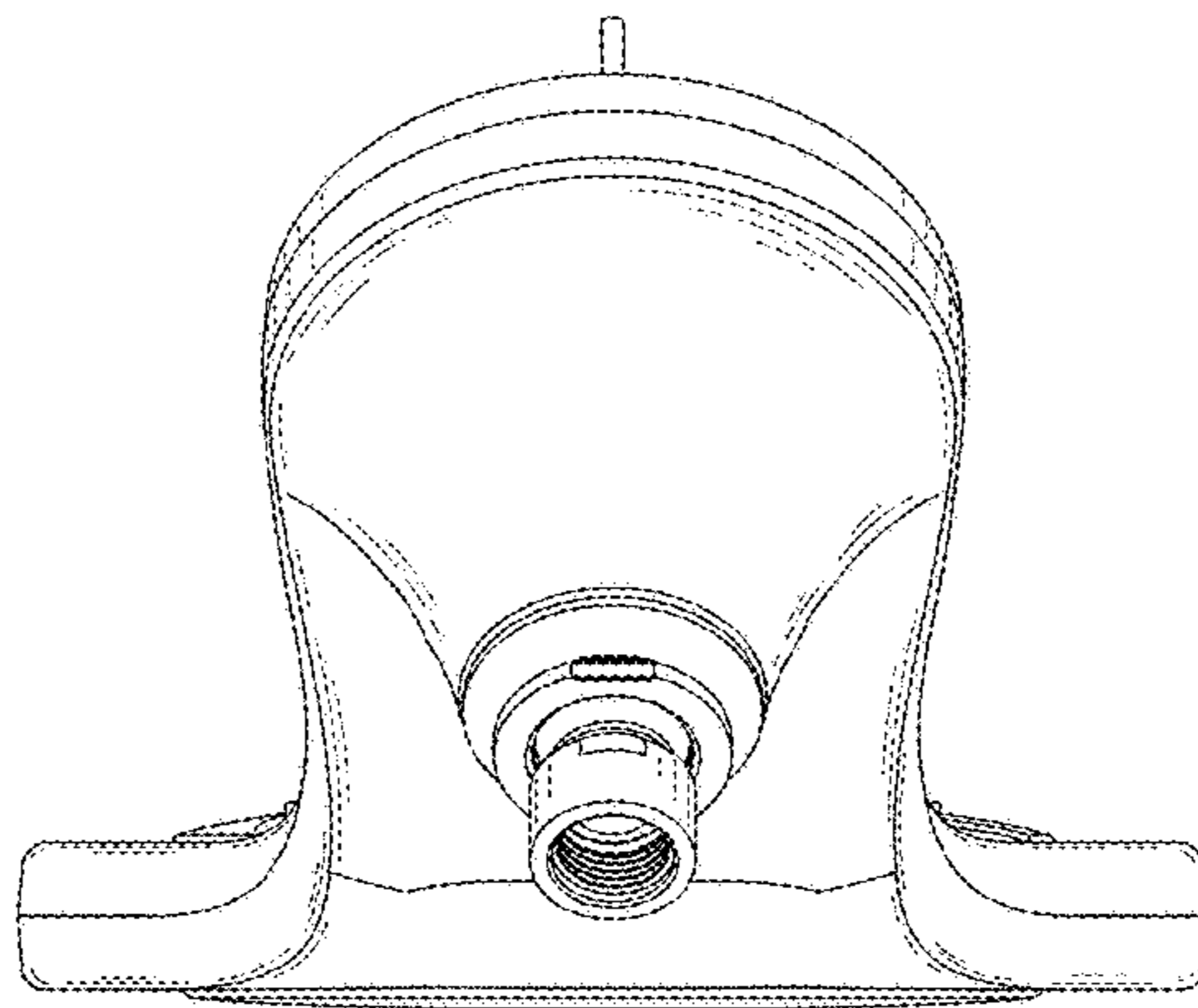

Fig. 6

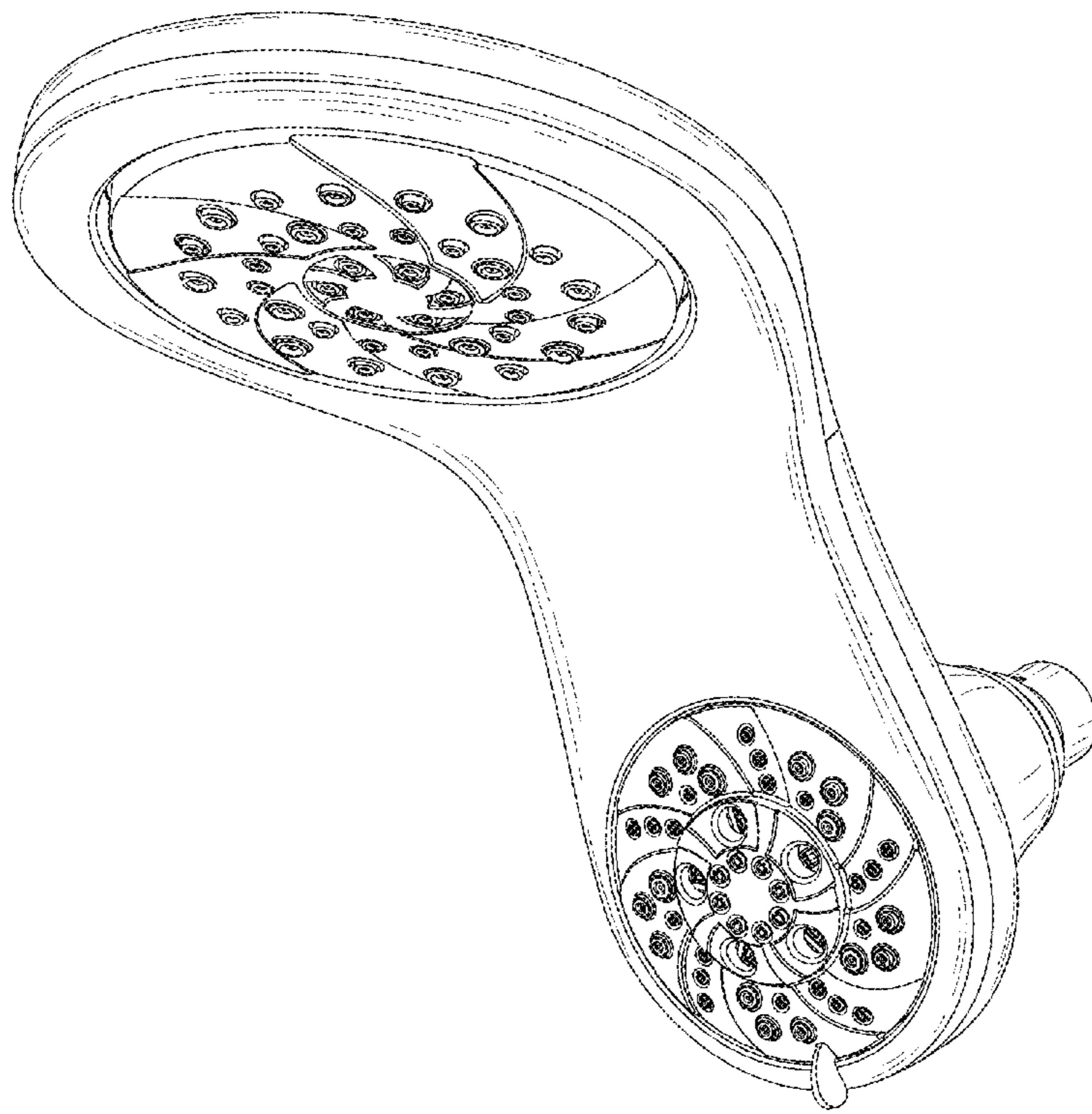

Fig. 7