



US00D842414S

(12) **United States Design Patent**  
**Ligeri**

(10) **Patent No.:** **US D842,414 S**

(45) **Date of Patent:** **\*\* Mar. 5, 2019**

(54) **BALD EAGLE RING FLOAT**

(71) Applicant: **Kangaroo Manufacturing, Inc.**,  
Tempe, AZ (US)

(72) Inventor: **Justin Ligeri**, Tempe, AZ (US)

(\*\*) Term: **15 Years**

(21) Appl. No.: **29/639,862**

(22) Filed: **Mar. 9, 2018**

(51) **LOC (11) Cl.** ..... **21-02**

(52) **U.S. Cl.**  
USPC ..... **D21/808**

(58) **Field of Classification Search**  
USPC ..... D6/597-599, 601; D12/316; D21/803,  
D21/805-806, 808, 809

CPC .. A63B 21/4005; A47C 15/006; A47C 15/008  
See application file for complete search history.

(56) **References Cited**

**U.S. PATENT DOCUMENTS**

D21,031 S *	9/1891	Ohmer	.....	D12/301
1,566,858 A	12/1925	Guinzburg		
D140,823 S *	4/1945	Earnest	.....	D11/149
D161,906 S	2/1951	Cohen		
D162,333 S	3/1951	Moore		
2,581,545 A	1/1952	Long		
D291,910 S *	9/1987	Wolfe	.....	D21/620
D298,197 S *	10/1988	Bussell	.....	D11/149
D348,164 S *	6/1994	Hollinger	.....	D6/539
D360,906 S *	8/1995	Hackett	.....	D21/428
D455,388 S	4/2002	McKeeta		
D455,674 S *	4/2002	Ancona	.....	D11/162
D487,714 S *	3/2004	Weiser	.....	D11/149
D496,410 S *	9/2004	Weiser	.....	D11/162
D519,594 S	4/2006	Brown		
D526,689 S	8/2006	Marshall et al.		
D564,397 S *	3/2008	Sartin	.....	D11/158
D722,667 S	2/2015	Hsu		
D725,209 S	3/2015	Wampold		
D726,273 S	4/2015	Wampold		

D741,218 S *	10/2015	Tao	.....	D11/158
D741,435 S	10/2015	Brown et al.		
D759,182 S	6/2016	Wampold		
D775,295 S	12/2016	Wampold		
D783,370 S	4/2017	Su et al.		
D785,119 S	4/2017	Hempton		
D785,120 S	4/2017	Wampold		
D787,617 S	5/2017	Krepack		
D798,620 S *	10/2017	Liu	.....	D6/345
D799,627 S	10/2017	de Grasse		

(Continued)

**OTHER PUBLICATIONS**

Coconut Float Patriotic Bald Eagle Pool Float: Published: Jun. 7, 2018 [online], site visited Oct. 22, 2018 Available from Internet URL: [https://www.amazon.com/Coconut-Float-Pool-Floats-Eagle/dp/B01M1URZ9E/ref=sr\\_1\\_4?ie=UTF8&qid=1540238421&sr=8-4&keywords=Coconut+Float.\\*](https://www.amazon.com/Coconut-Float-Pool-Floats-Eagle/dp/B01M1URZ9E/ref=sr_1_4?ie=UTF8&qid=1540238421&sr=8-4&keywords=Coconut+Float.*)

*Primary Examiner* — Garth Rademaker

*Assistant Examiner* — Melvin L Davis

(74) *Attorney, Agent, or Firm* — Goldstein Law Offices, P.C.

(57) **CLAIM**

The ornamental design for a bald eagle ring float, as shown and described.

**DESCRIPTION**

FIG. 1 is a perspective view of a bald eagle ring float; FIG. 2 is a front elevational view of the bald eagle ring float. FIG. 3 is a rear elevational view thereof. FIG. 4 is a right side elevational view thereof. FIG. 5 is a left side elevational view thereof. FIG. 6 is a top plan view thereof; and, FIG. 7 is a bottom plan view thereof. The broken lines depict surface indicia that forms no part of the claimed design.

**1 Claim, 4 Drawing Sheets**

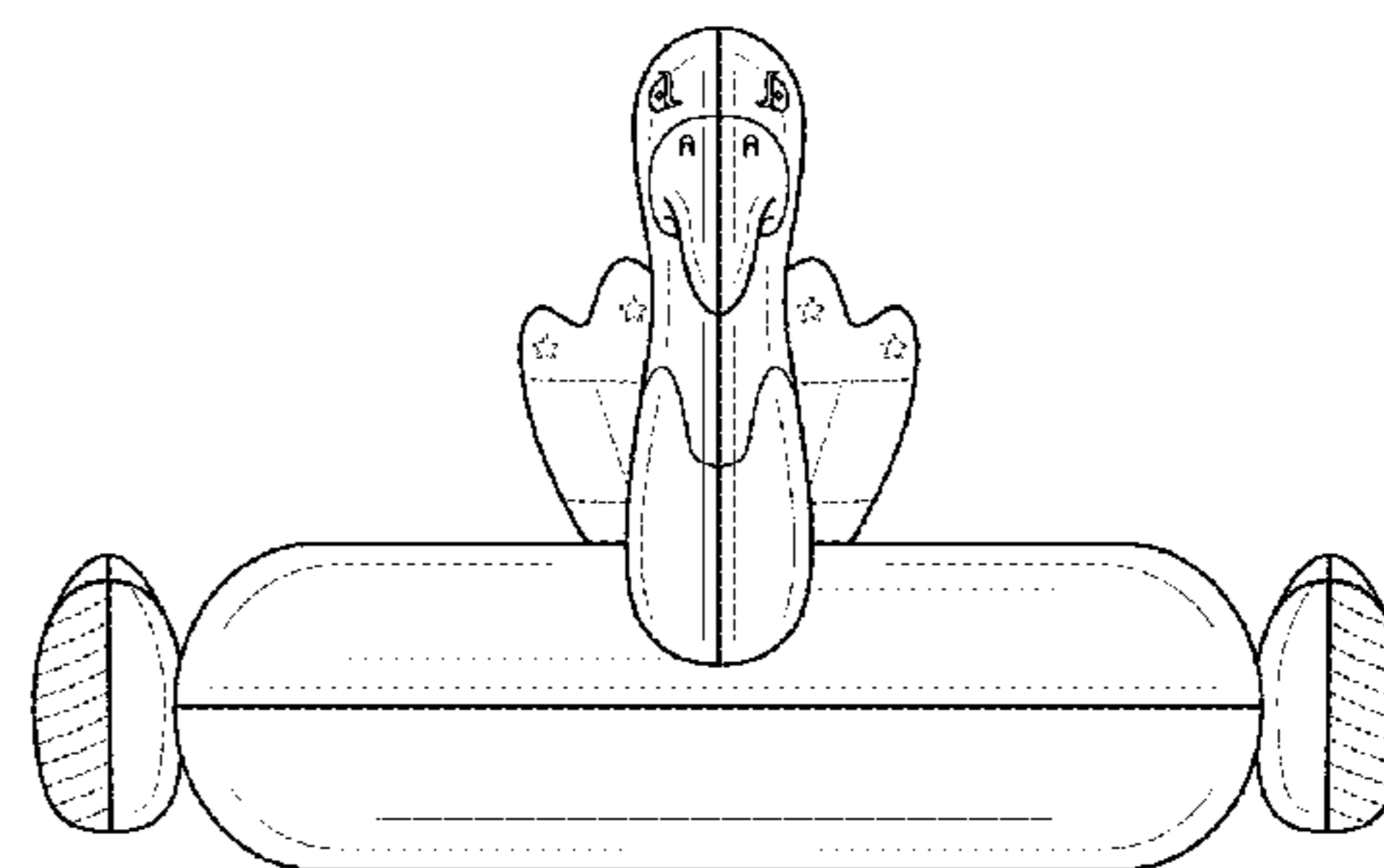
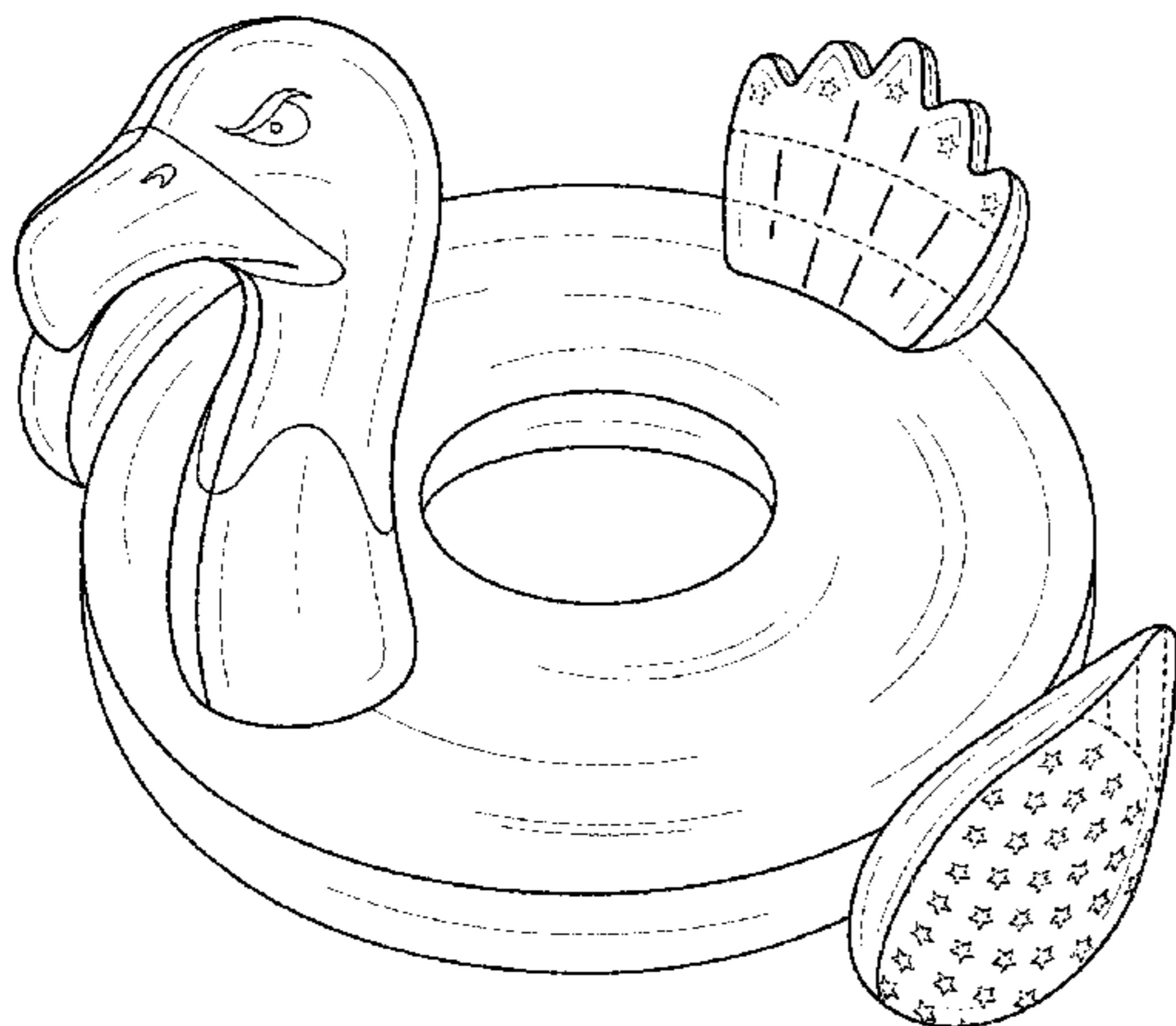

(56)

**References Cited**

U.S. PATENT DOCUMENTS

D802,075 S	11/2017	Wampold	
D803,339 S	11/2017	Wampold	
D806,815 S	1/2018	Su	
D827,751 S *	9/2018	Ligeri .....	D21/808
2004/0072132 A1 *	4/2004	Burtness .....	G09B 19/02
			434/188
2012/0228175 A1 *	9/2012	Ressel .....	E04H 4/14
			206/457

\* cited by examiner

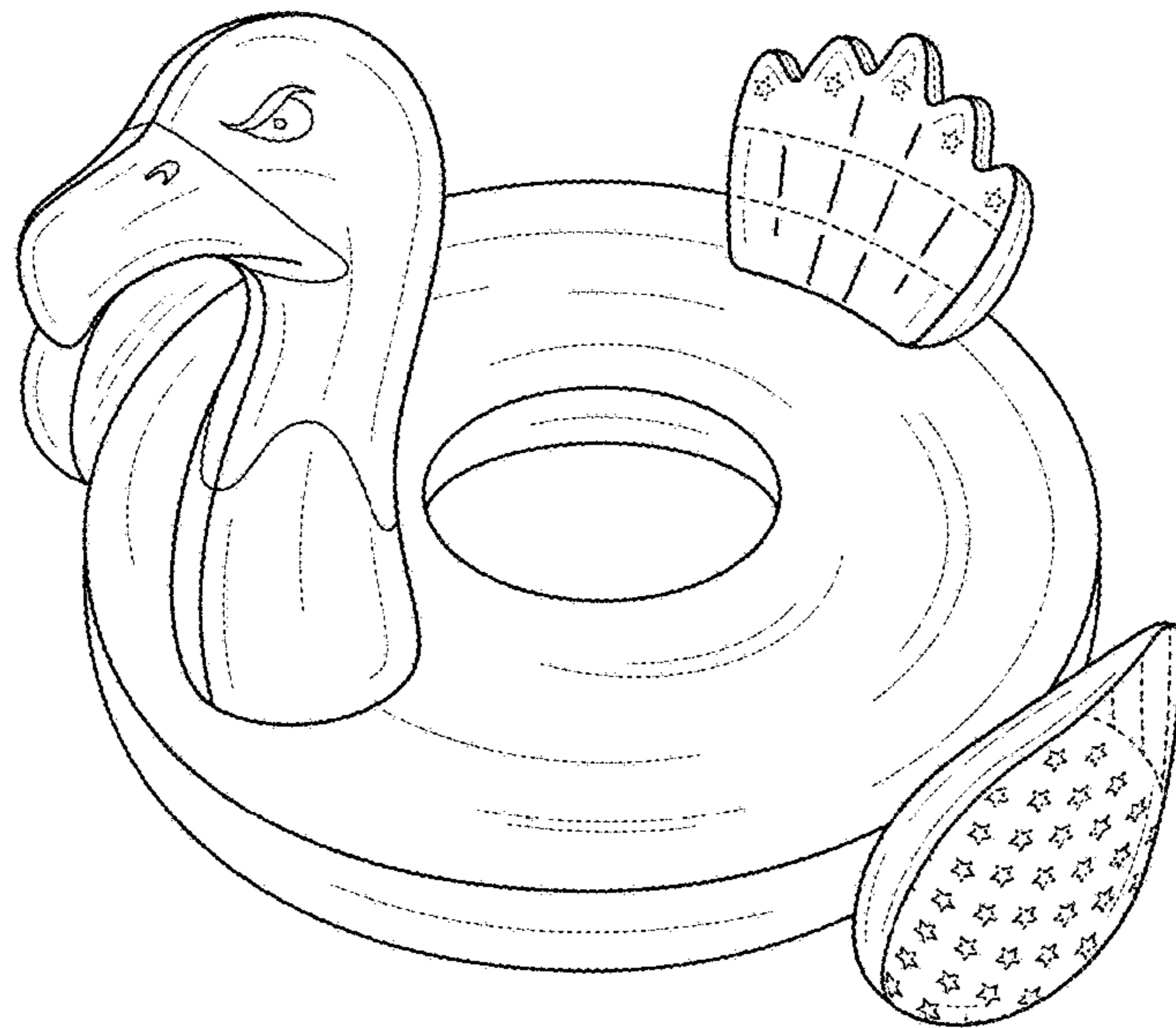

FIG. 1

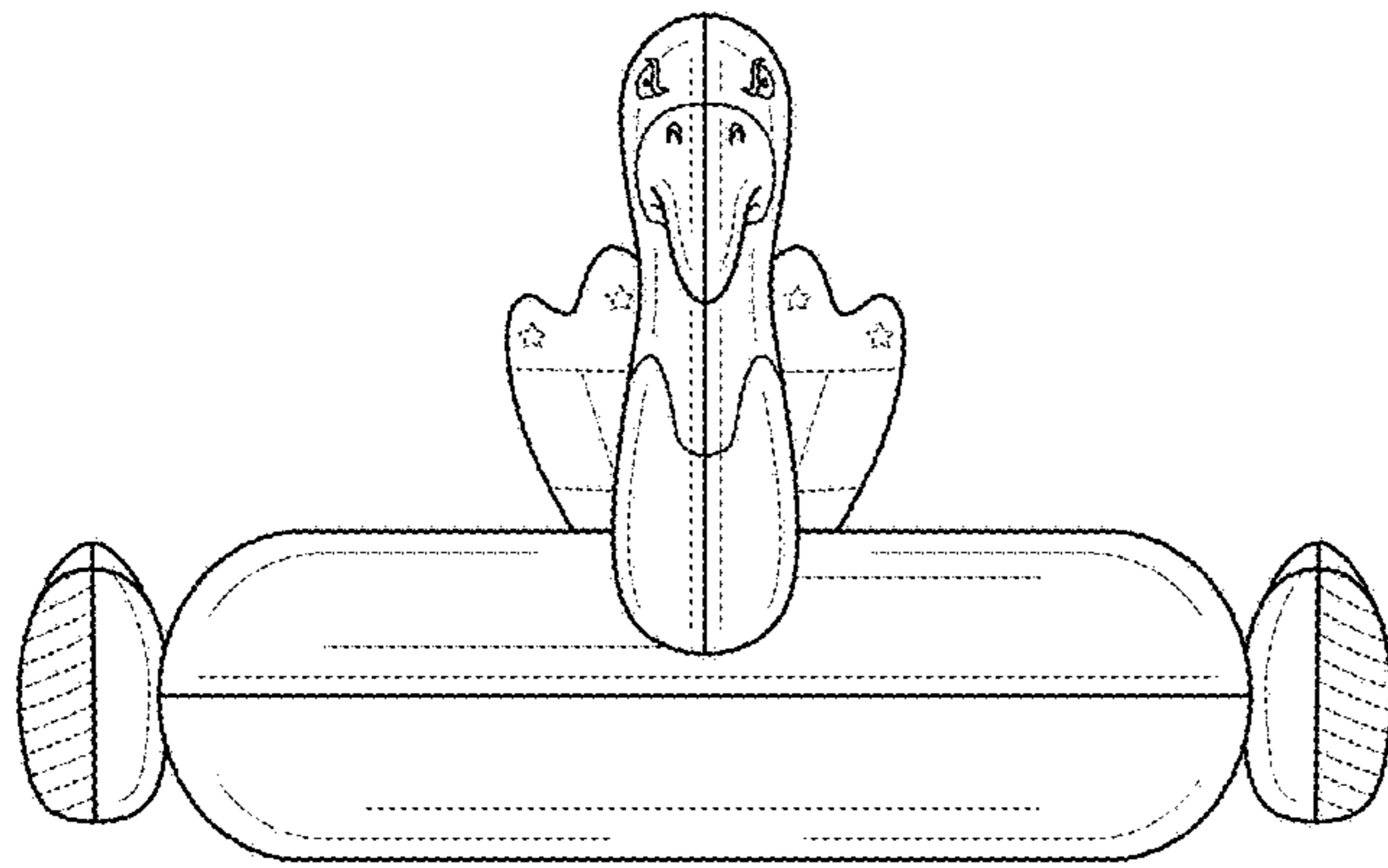

FIG. 2

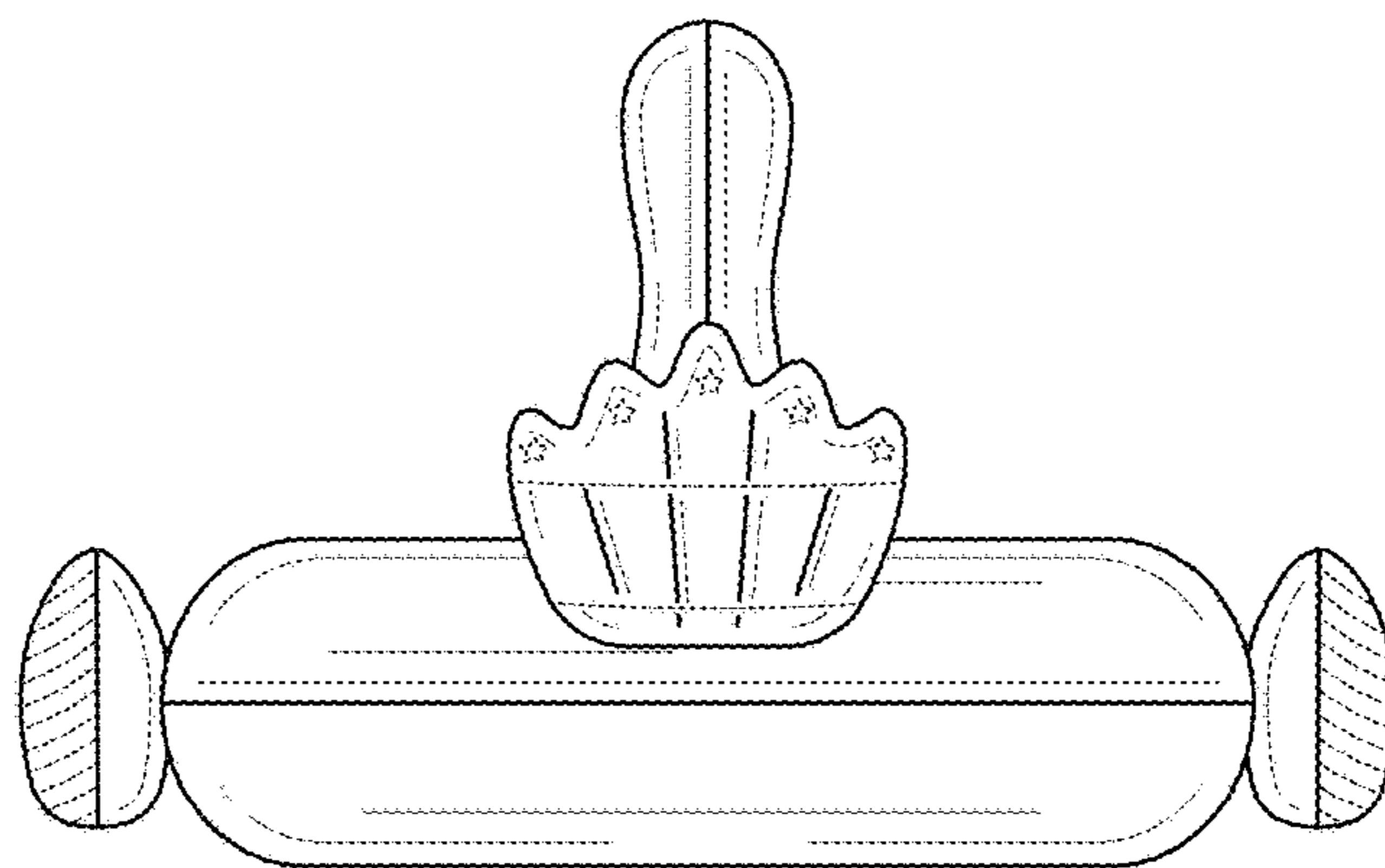

FIG. 3

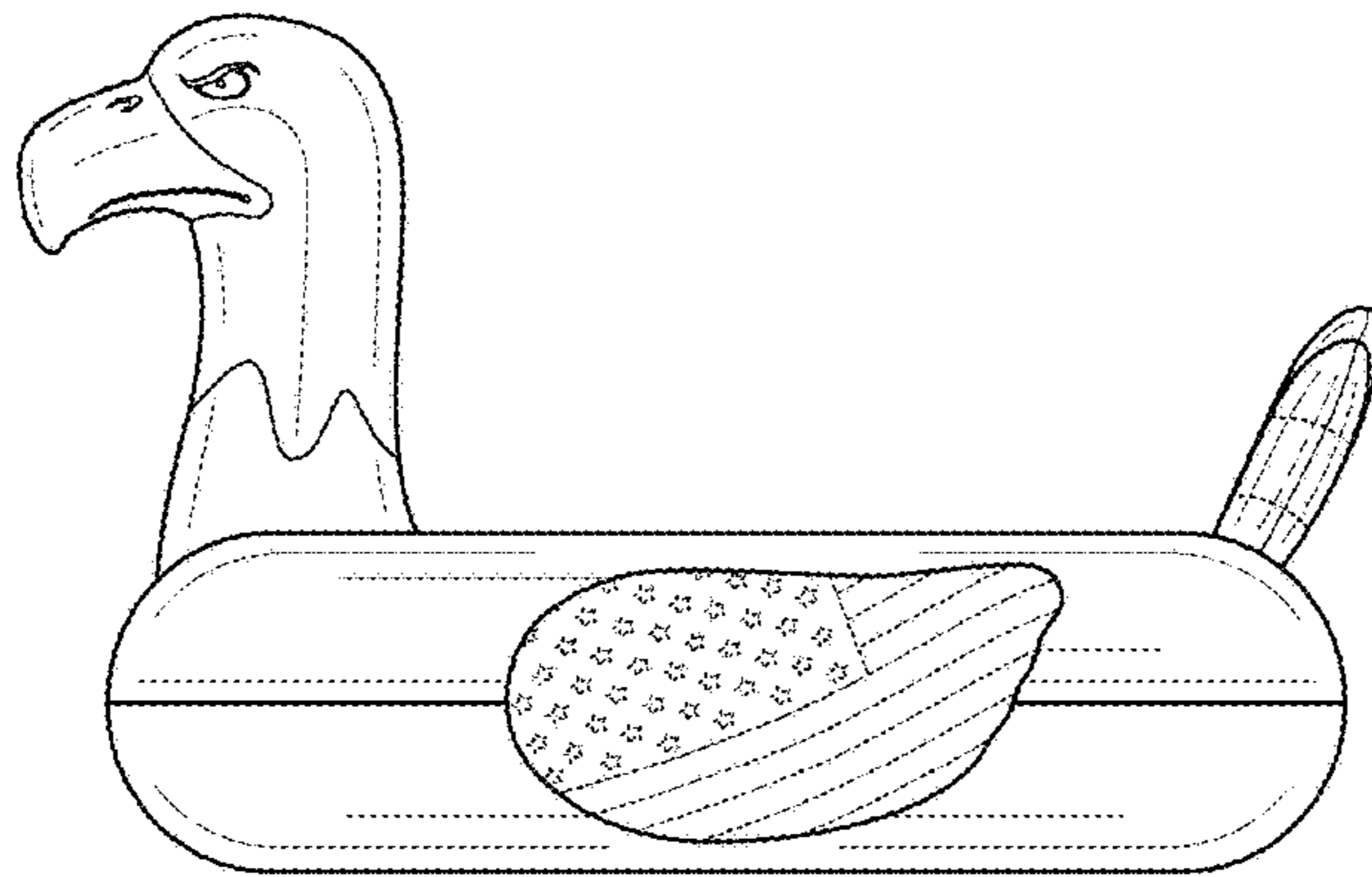

FIG. 4

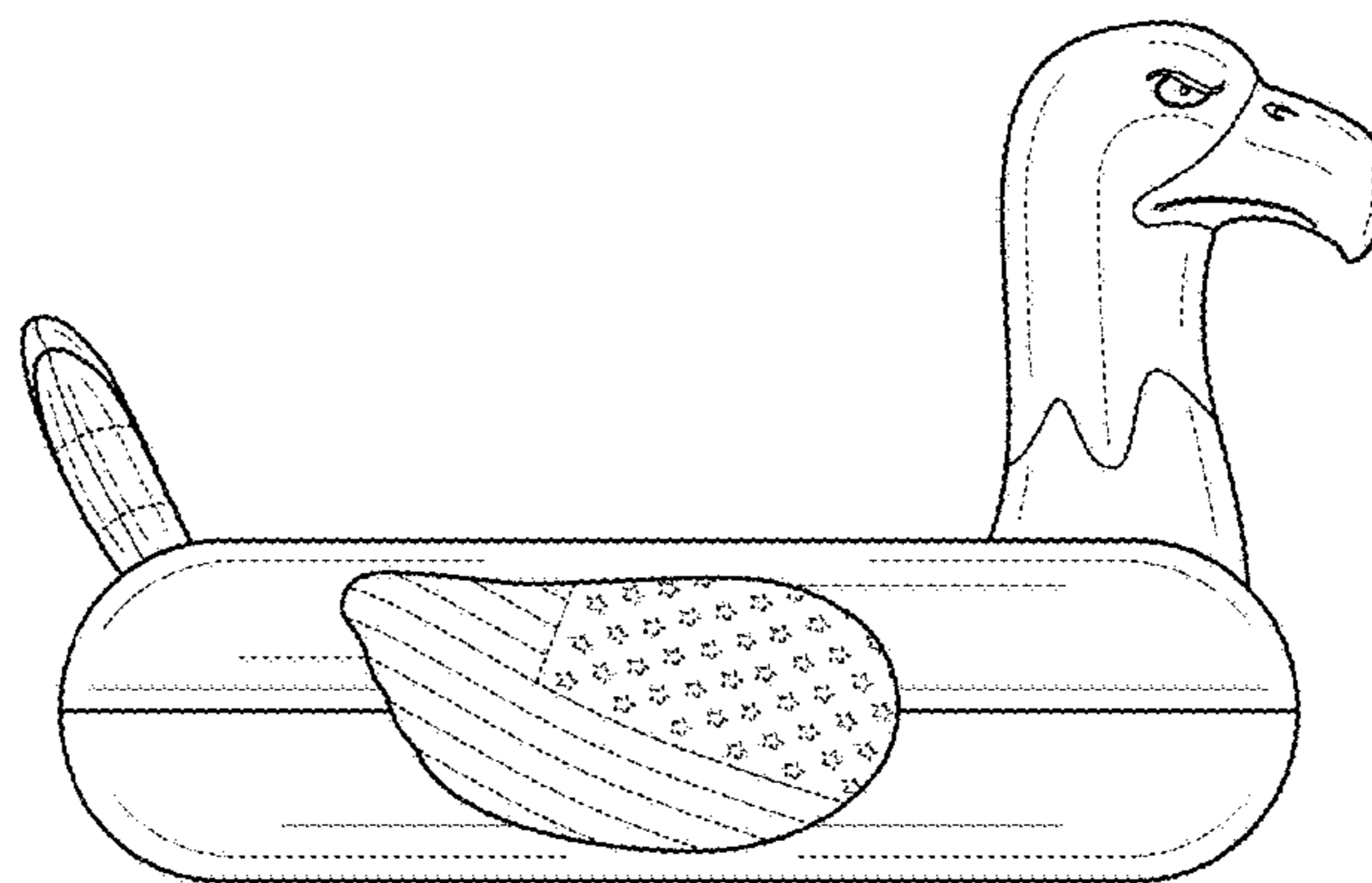

FIG. 5

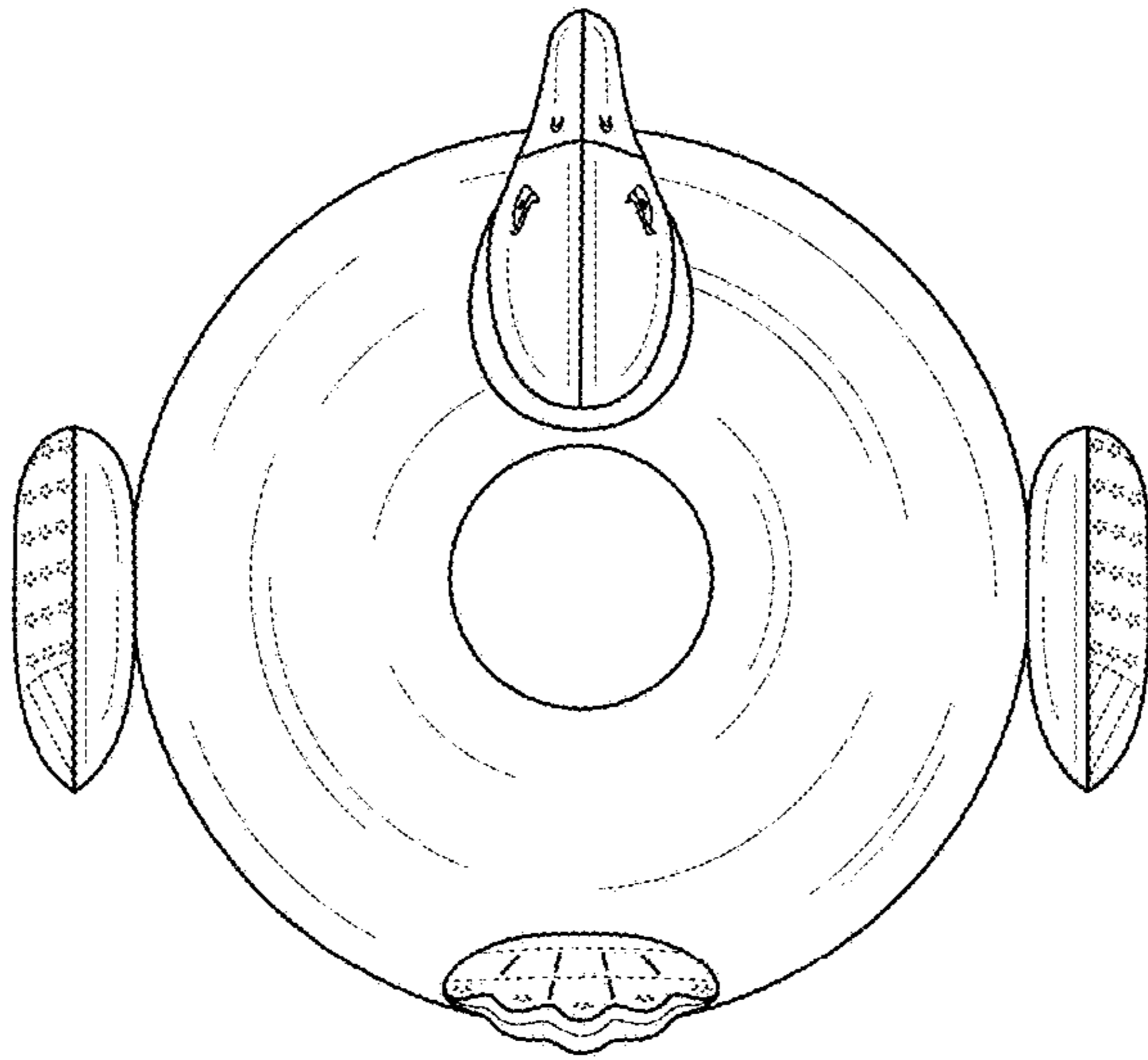

FIG. 6

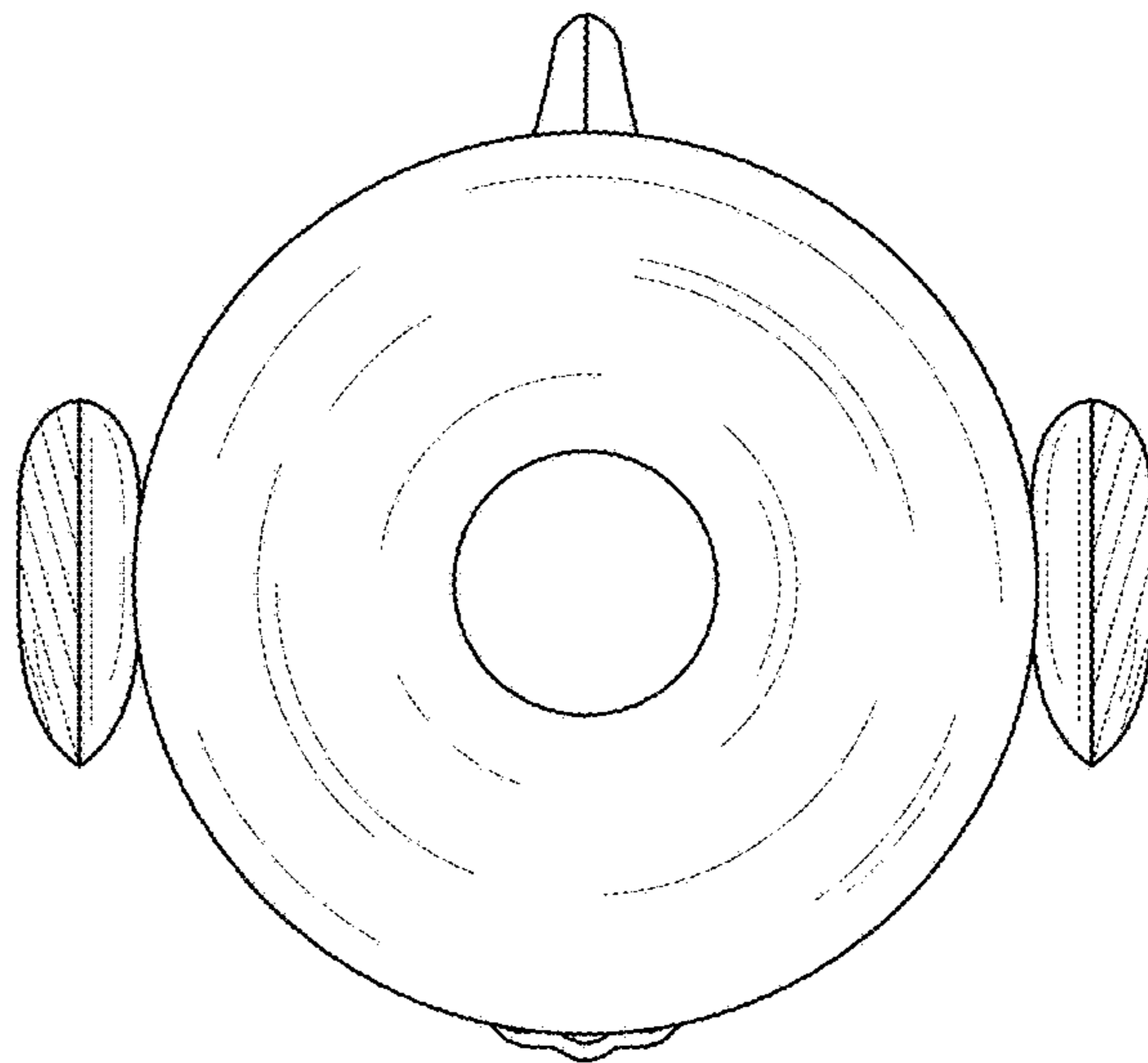

FIG. 7