

US00D842290S

(12) **United States Design Patent** (10) **Patent No.:** **US D842,290 S**
Robertson (45) **Date of Patent:** **** Mar. 5, 2019**

(54) **MOBILE COMMUNICATION DEVICE CASE**

(71) Applicant: **Kai Robertson**, Chicago, IL (US)

(72) Inventor: **Kai Robertson**, Chicago, IL (US)

(**) Term: **15 Years**

(21) Appl. No.: **29/596,096**

(22) Filed: **Mar. 6, 2017**

(51) **LOC (11) Cl.** **14-03**

(52) **U.S. Cl.**

USPC **D14/250**; D14/251

(58) **Field of Classification Search**

USPC D2/639; D3/201, 218, 232, 233, 239,
D3/242, 245-247, 269, 273, 301, 303,
D3/318, 327, 328; D11/212, 218, 231,
D11/222, 236, 237; D13/103, 107, 108,
D13/119; D14/137, 138 R, 138 AA,
D14/138 C, 138 G, 203.3-203.7, 217,
D14/238.1, 247, 248, 250, 251-253, 439,
D14/440; D21/662, 692

CPC H04B 1/3888; H04M 1/0283;
H04M 1/0202; A45C 1/06; A45C
2011/002; A45C 23/02; A45C 11/00;
A45F 2005/028; A45F 2200/0525; A45F
2200/0516

See application file for complete search history.

(56) **References Cited**

U.S. PATENT DOCUMENTS

823,868 A * 6/1906 Huntington et al. .. A44B 11/24
24/163 R
1,865,509 A * 7/1932 Domkee A44B 11/04
24/200
2,231,259 A * 2/1941 Elwell A44B 11/04
24/200
D271,413 S * 11/1983 Munroe D22/147
D271,820 S * 12/1983 Allen 224/250
D288,865 S * 3/1987 Nace D3/218
D290,349 S * 6/1987 Kasai D11/218
D303,456 S * 9/1989 Selisky D11/201
D313,122 S * 12/1990 De Gray 224/251
D388,249 S * 12/1997 Negron D3/218

D490,238 S * 5/2004 Bristel D3/226
D590,386 S 4/2009 Leith et al.
D597,737 S * 8/2009 Collins D27/186
D620,252 S * 7/2010 Keels D3/247
D649,087 S * 11/2011 Harada D11/218
D667,172 S 9/2012 Baum et al.
D673,162 S 12/2012 Young
D674,380 S 1/2013 Soekoro
D675,197 S * 1/2013 Losiewicz D14/250
D677,252 S 3/2013 Baum et al.
D685,376 S * 7/2013 Kim D14/439
D687,026 S 7/2013 Ruvolo
D689,477 S 9/2013 Baum et al.
D689,479 S 9/2013 Soffer
D701,043 S * 3/2014 Minn D3/247
D703,647 S * 4/2014 Kim D14/250
D703,658 S * 4/2014 Higashi D14/253
D705,767 S * 5/2014 Yoon D14/250
8,746,448 B1 6/2014 Bellace
D711,866 S 8/2014 Kawata
D716,287 S 10/2014 Ambriz
D717,780 S * 11/2014 Tussy D14/250
D721,373 S 1/2015 Logereau
D721,691 S * 1/2015 Kim D14/250
8,950,638 B2 2/2015 Wangerey, Jr. et al.
D724,310 S 3/2015 Dong
D725,659 S * 3/2015 Tussy D14/440
D729,787 S 5/2015 Soekoro
D729,790 S 5/2015 Baum et al.
D735,695 S 8/2015 Murphy
D738,872 S * 9/2015 Erickson-Davis D14/250
D743,409 S 11/2015 Chen
9,179,565 B2 11/2015 Cho
9,185,197 B2 11/2015 Keesling et al.
D749,069 S 2/2016 Senoff
D749,083 S 2/2016 Senoff
D749,559 S 2/2016 Senoff
D753,912 S 4/2016 Spero
D765,662 S 9/2016 Kang
D769,854 S * 10/2016 Duval D14/250
D775,619 S 1/2017 Tien
2009/0090750 A1 4/2009 Alcenat
2011/0034221 A1 2/2011 Hung et al.
2013/0277992 A1 10/2013 Senoff
2014/0151417 A1 6/2014 Gayler
2014/0252786 A1 * 9/2014 Singhal G06F 1/1626
294/137
2015/0327642 A1 11/2015 Lee, Sr.

OTHER PUBLICATIONS

MingShore silicone rugged case, posted at Dhgate.com, posting date Jan. 5, 2017, [online], [site visited Feb. 13, 2018]. Available

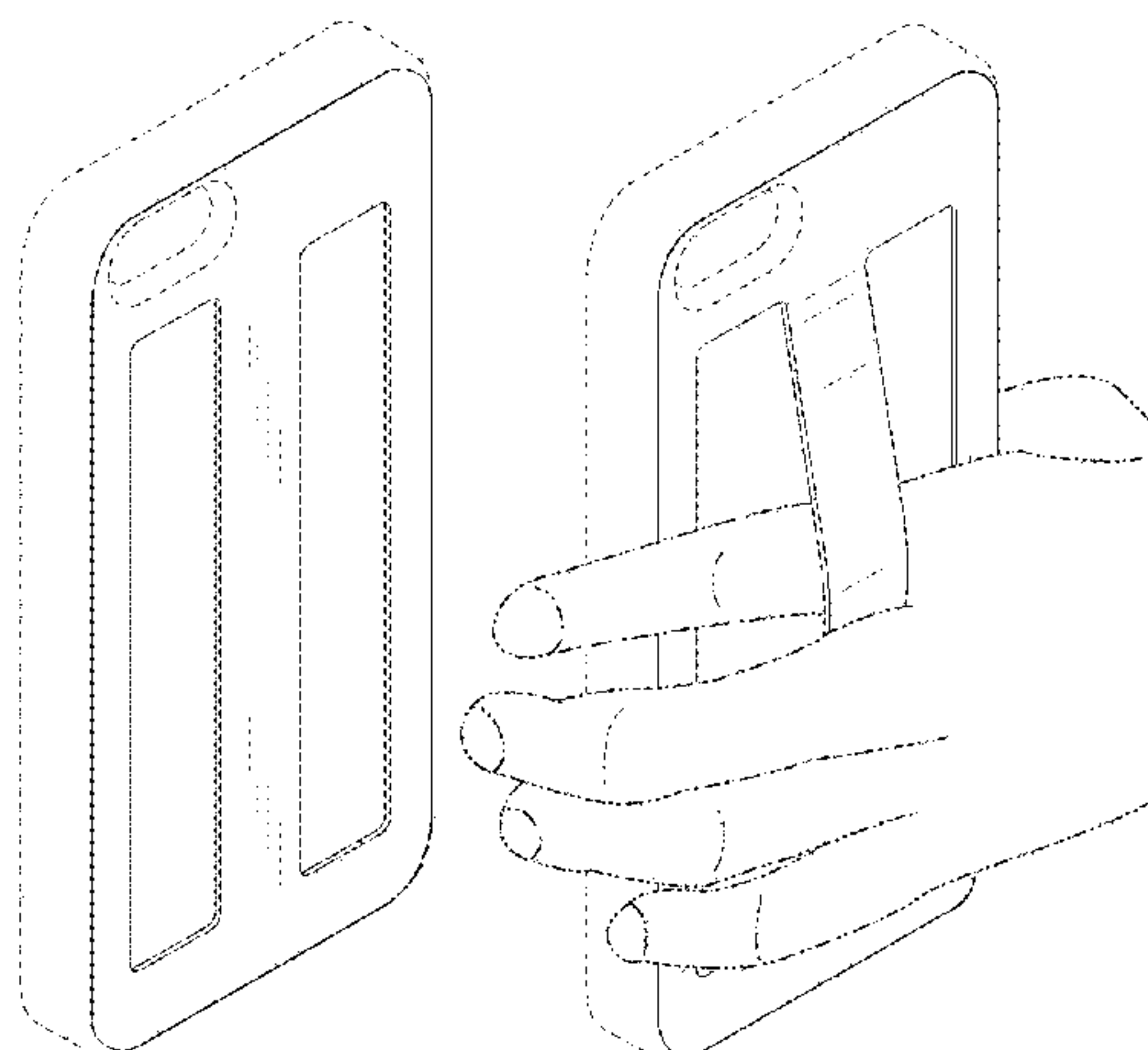

from Internet, <URL: <https://www.dhgate.com/product/mingshore-portable-exquisite-hand-band-design/397517196.html>>.*

UMX Fashion buckle series, posted at Umei.com, posting date Oct. 10, 1999, [online], [site visited Feb. 13, 2018]. Available from Internet, <URL: <https://www.umei.com/adjusters/buckle-adjusters-4.htm>>.*

Claro 2 Gang Decorator Wallplate by Lutron, posted at Homedepot.com, posting date Jul. 26, 2012, [online], [site visited Feb. 13, 2018]. Available from Internet, <URL: <https://www.homedepot.com/p/Lutron-Claro-2-Gang-Decorator-Wallplate-Biscuit-SC-2-BI/202102217>>.*

Daypack by Topo Designs, posted at Topodesigns.com, posting date Sep. 22, 2014, [online], [site visited Feb. 13, 2018]. Available from Internet, <URL: <https://topodesigns.com/products/daypack>>.*

* cited by examiner

Primary Examiner — Susan E Krakower

Assistant Examiner — L. A. Grabenstetter

(74) *Attorney, Agent, or Firm* — Cooley LLP; Nathan W. Poulsen

(57) **CLAIM**

The ornamental design for a mobile communication device case, as show and described.

DESCRIPTION

FIG. 1 is a front perspective view of a first embodiment of the new design for a mobile communication device case, with a strap in a collapsed configuration;
 FIG. 2 is a rear perspective view thereof;
 FIG. 3 is a front view thereof;
 FIG. 4 is a rear view thereof;
 FIG. 5 is a left side view thereof;
 FIG. 6 is a right side view thereof;
 FIG. 7 is a top view thereof;
 FIG. 8 is a bottom view thereof;
 FIG. 9 is a front perspective view of the first embodiment of the new design for a mobile communication device case, with the strap in an extended configuration;
 FIG. 10 is a rear perspective view thereof;
 FIG. 11 is a front view thereof;
 FIG. 12 is a rear view thereof;
 FIG. 13 is a left side view thereof;
 FIG. 14 is a right side view thereof;
 FIG. 15 is a top view thereof;
 FIG. 16 is a bottom view thereof;
 FIG. 17 is a front perspective view thereof, showing an example use;
 FIG. 18 is a front view of a second embodiment of the new design for a mobile communication device case, with a strap in a collapsed configuration;
 FIG. 19 is a rear view thereof;
 FIG. 20 is a left side view thereof;
 FIG. 21 is a right side view thereof;
 FIG. 22 is a top view thereof;
 FIG. 23 is a bottom view thereof;
 FIG. 24 is a front view of the second embodiment of the new design for a mobile communication device case, with the strap in an extended configuration;
 FIG. 25 is a rear view thereof;
 FIG. 26 is a left side view thereof;
 FIG. 27 is a right side view thereof;
 FIG. 28 is a top view thereof;
 FIG. 29 is a bottom view thereof;

FIG. 30 is a front view of a third embodiment of the new design for a mobile communication device case, with a strap in a collapsed configuration;
 FIG. 31 is a rear view thereof;
 FIG. 32 is a left side view thereof;
 FIG. 33 is a right side view thereof;
 FIG. 34 is a top view thereof;
 FIG. 35 is a bottom view thereof;
 FIG. 36 is a front view of the third embodiment of the new design for a mobile communication device case, with the strap in an extended configuration;
 FIG. 37 is a rear view thereof;
 FIG. 38 is a left side view thereof;
 FIG. 39 is a right side view thereof;
 FIG. 40 is a top view thereof;
 FIG. 41 is a bottom view thereof;
 FIG. 42 is a front view of a fourth embodiment of the new design for a mobile communication device case, with a strap in a collapsed configuration;
 FIG. 43 is a rear view thereof;
 FIG. 44 is a left side view thereof;
 FIG. 45 is a right side view thereof;
 FIG. 46 is a top view thereof;
 FIG. 47 is a bottom view thereof;
 FIG. 48 is a front perspective view of the fourth embodiment of the new design for a mobile communication device case, with the strap in an extended configuration;
 FIG. 49 is a front view thereof;
 FIG. 50 is a rear view thereof;
 FIG. 51 is a left side view thereof;
 FIG. 52 is a right side view thereof;
 FIG. 53 is a top view thereof;
 FIG. 54 is a bottom view thereof;
 FIG. 55 is a front view of a fifth embodiment of the new design for a mobile communication device case, with a strap in a collapsed configuration;
 FIG. 56 is a rear view thereof;
 FIG. 57 is a left side view thereof;
 FIG. 58 is a right side view thereof;
 FIG. 59 is a top view thereof;
 FIG. 60 is a bottom view thereof;
 FIG. 61 is a front view of the fifth embodiment of the new design for a mobile communication device case, with the strap in an extended configuration;
 FIG. 62 is a rear view thereof;
 FIG. 63 is a left side view thereof;
 FIG. 64 is a right side view thereof;
 FIG. 65 is a top view thereof;
 FIG. 66 is a bottom view thereof;
 FIG. 67 is a front view of a sixth embodiment of the new design for a mobile communication device case, with a strap in a collapsed configuration;
 FIG. 68 is a rear view thereof;
 FIG. 69 is a left side view thereof;
 FIG. 70 is a right side view thereof;
 FIG. 71 is a top view thereof;
 FIG. 72 is a bottom view thereof;
 FIG. 73 is a front view of the sixth embodiment of the new design for a mobile communication device case, with the strap in an extended configuration;
 FIG. 74 is a rear view thereof;
 FIG. 75 is a left side view thereof;
 FIG. 76 is a right side view thereof;
 FIG. 77 is a top view thereof; and,
 FIG. 78 is a bottom view thereof.

The dash-dot-dash broken lines represent the boundary of the claim, and form no part of the claimed design. The dash-dash broken lines show portions of the case which form no part of the claimed design. The dash-dot-dot-dash broken lines depicting a hand in FIG. 17 represent environmental subject matter that forms no part of the claimed design.

1 Claim, 54 Drawing Sheets

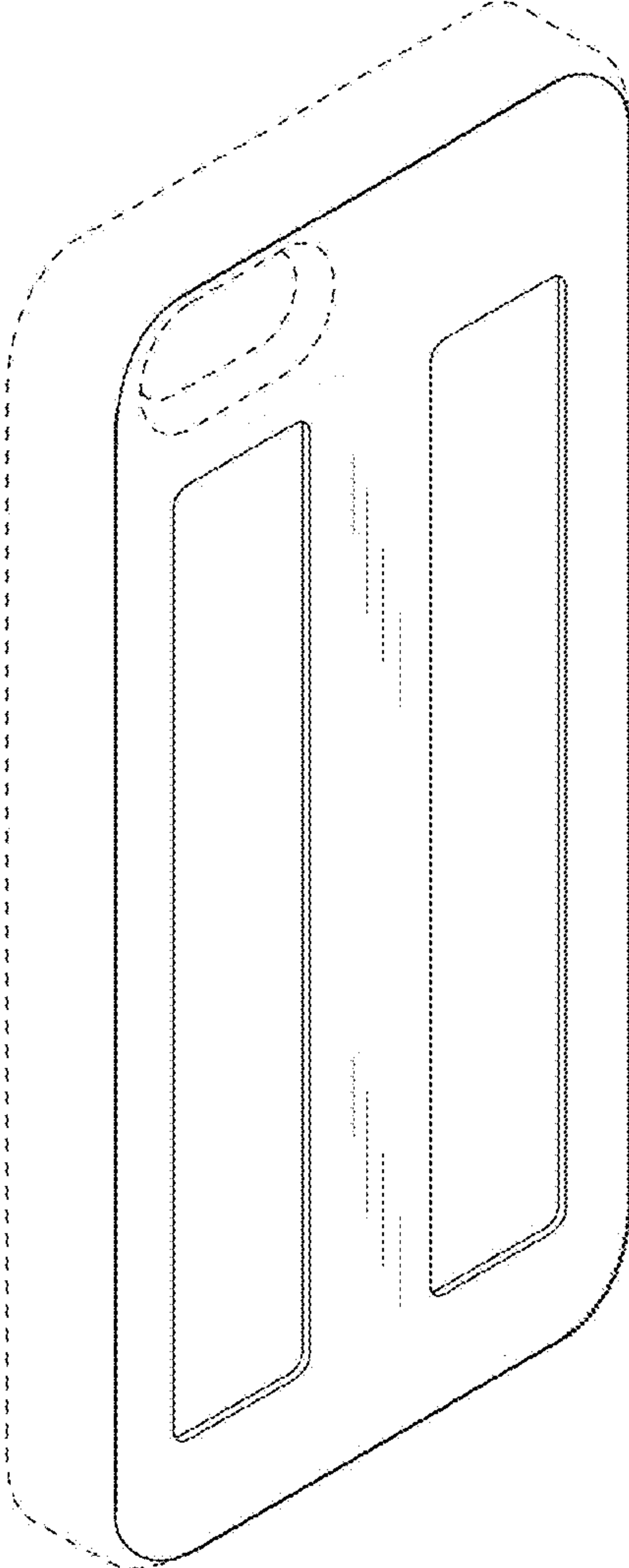

FIG. 1

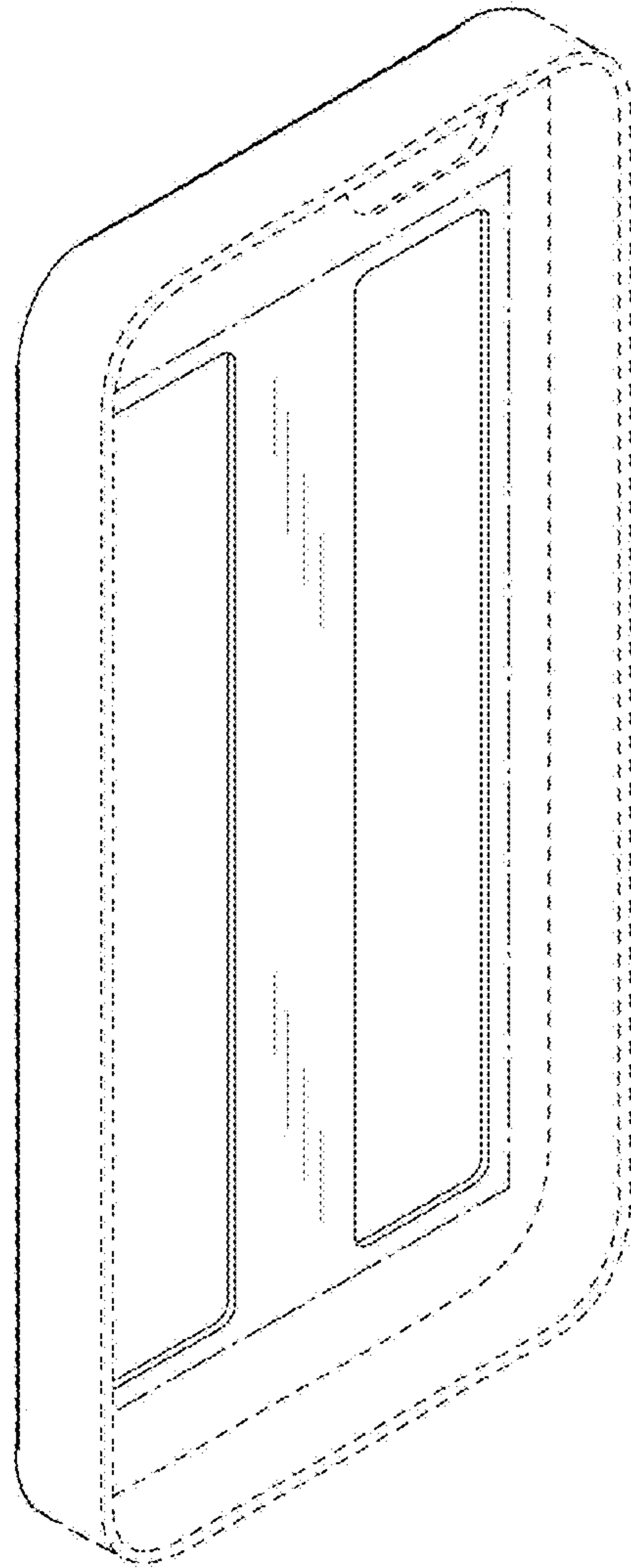

FIG. 2

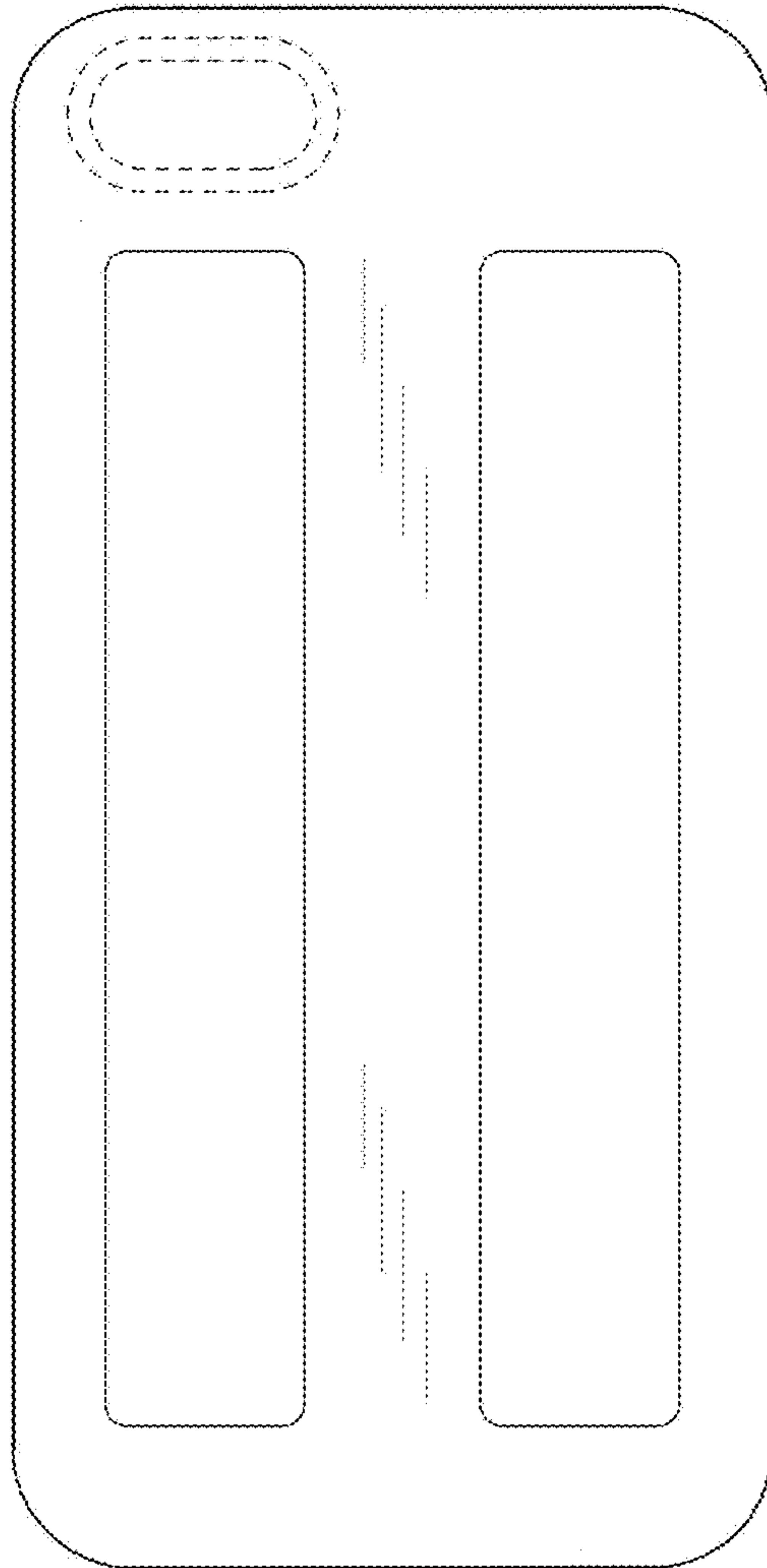

FIG. 3

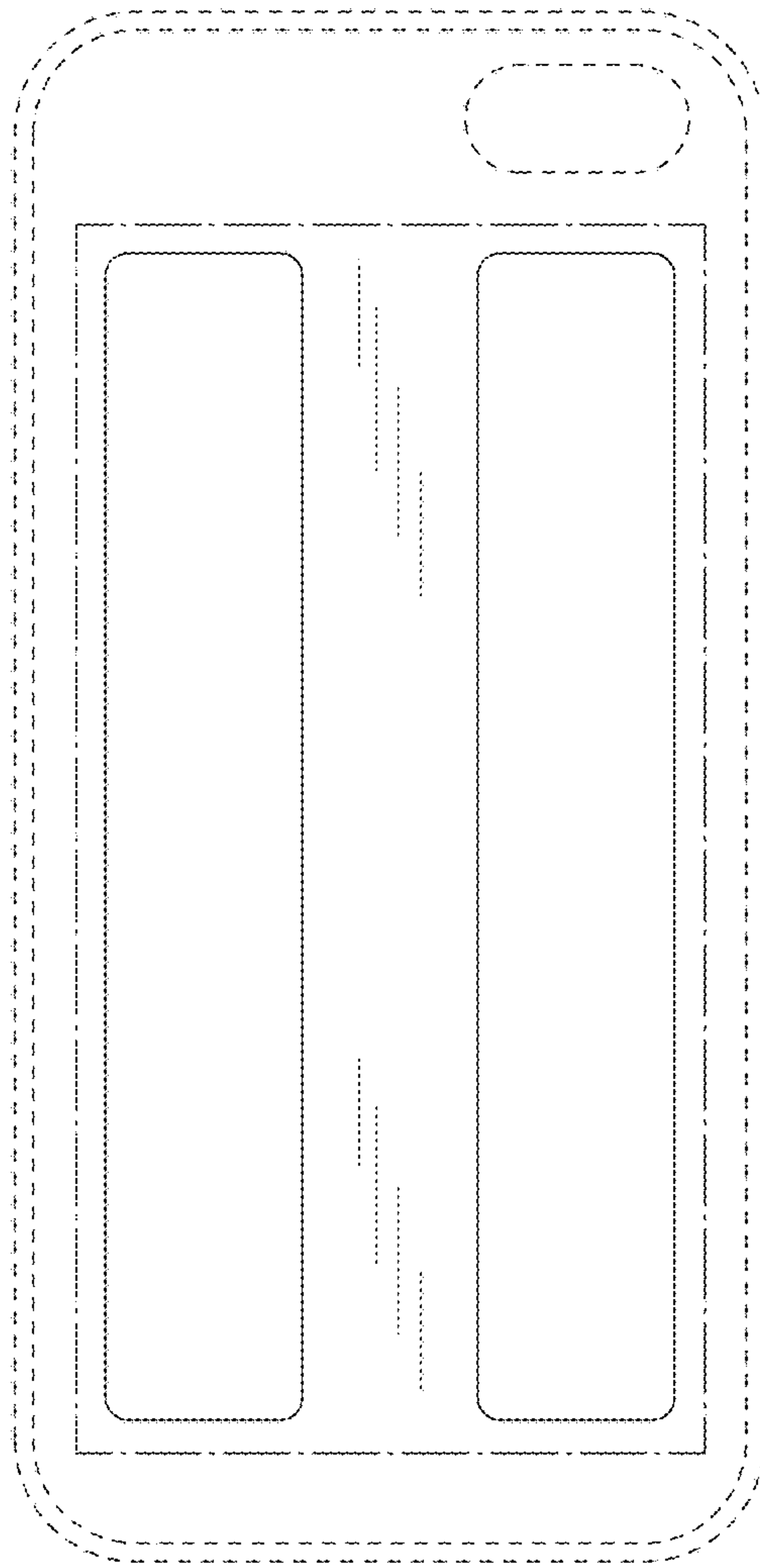

FIG. 4

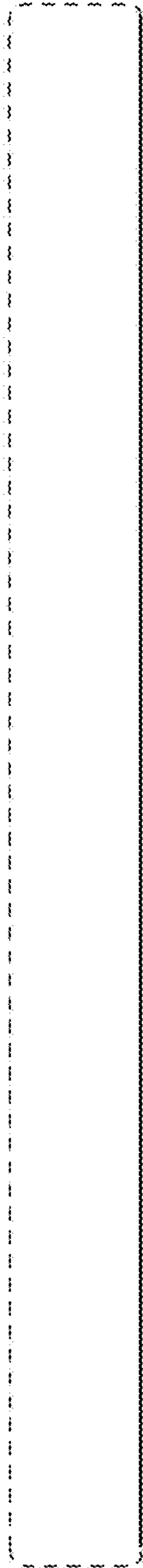

FIG. 5

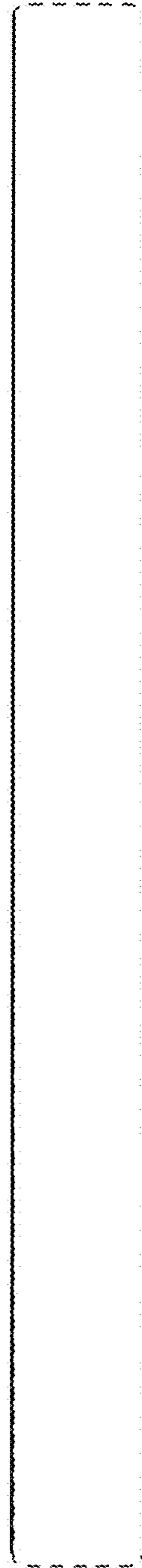

FIG. 6

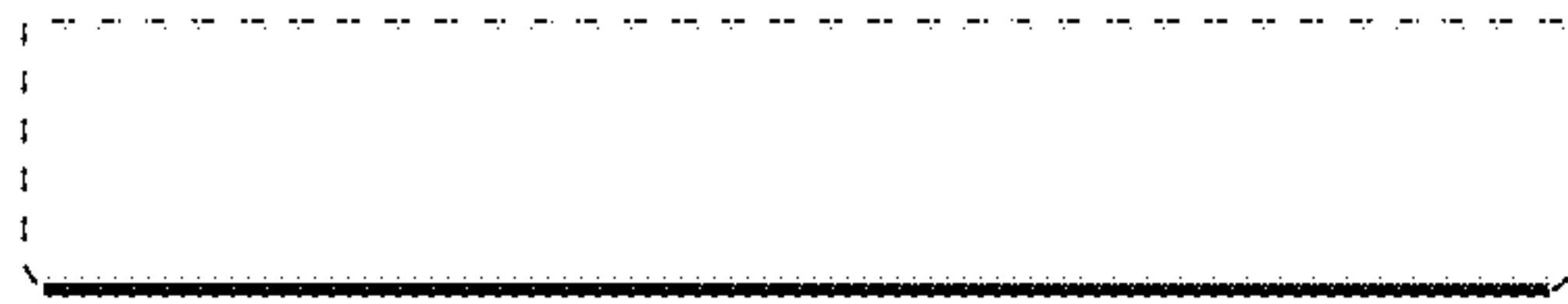

FIG. 7

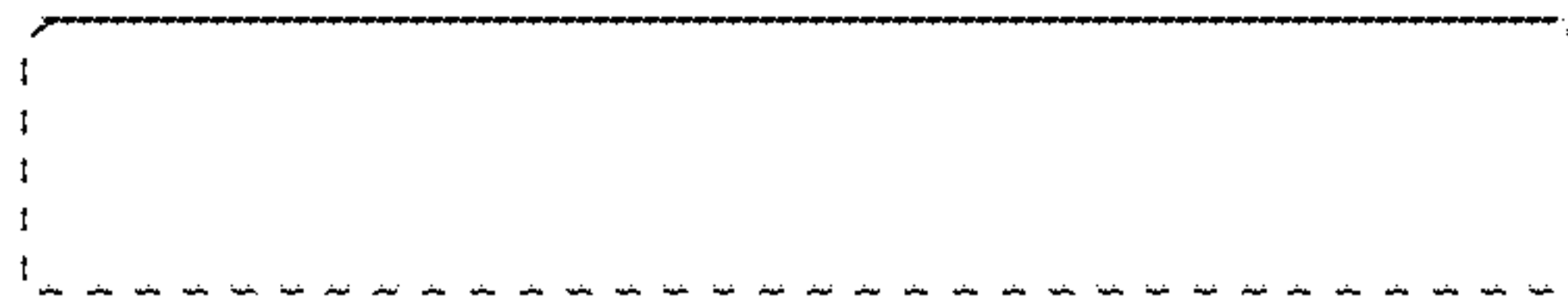

FIG. 8

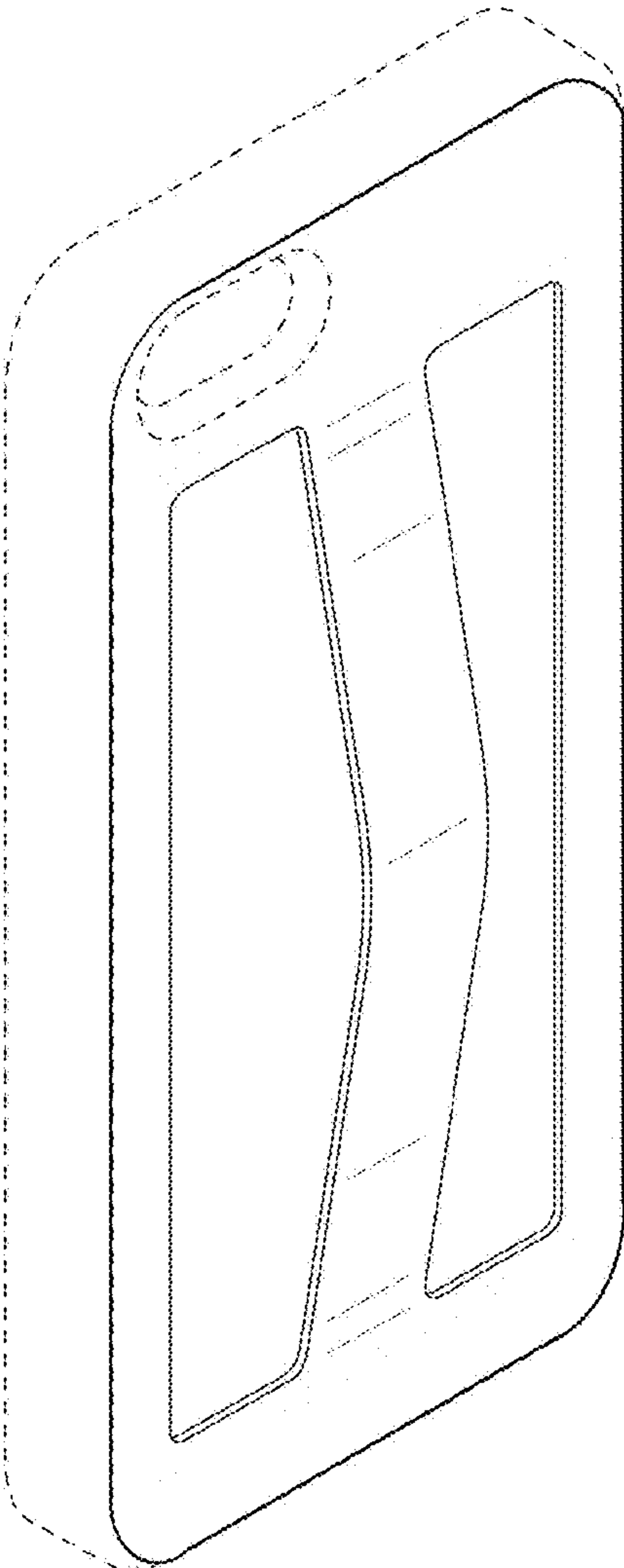

FIG. 9

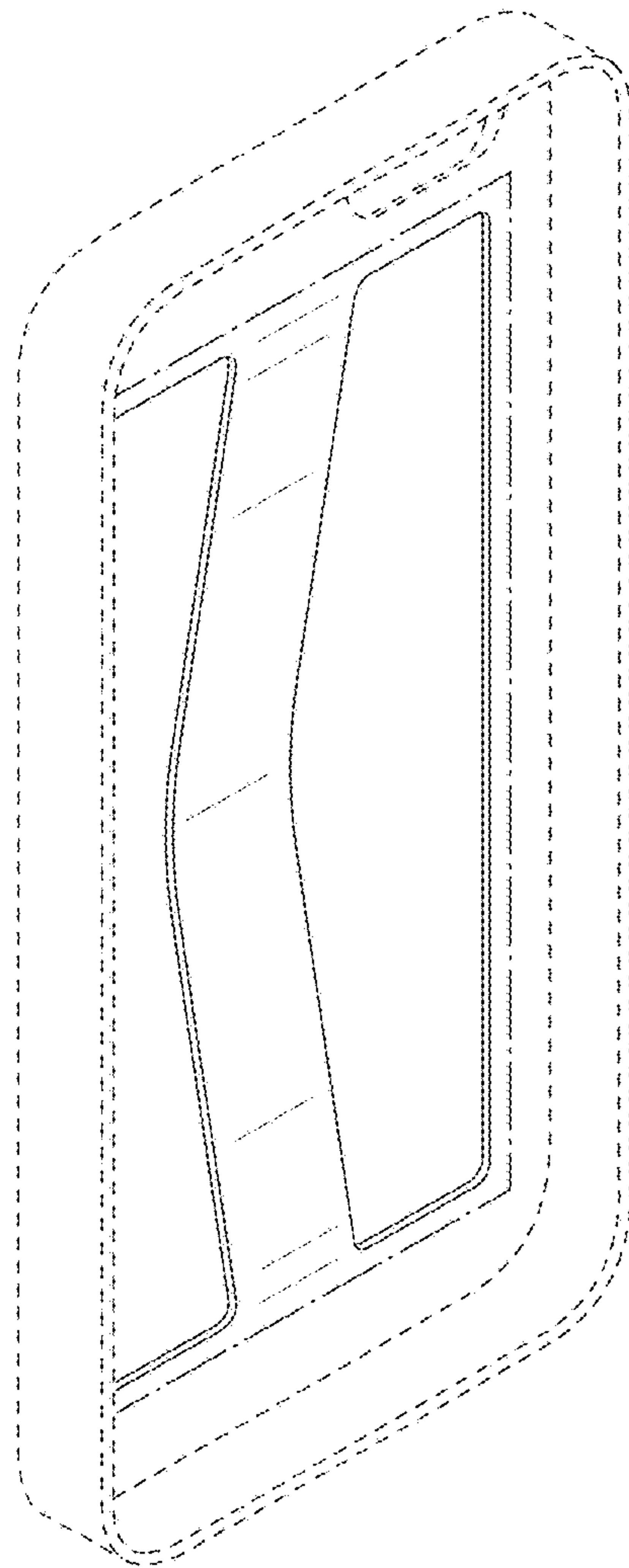

FIG. 10

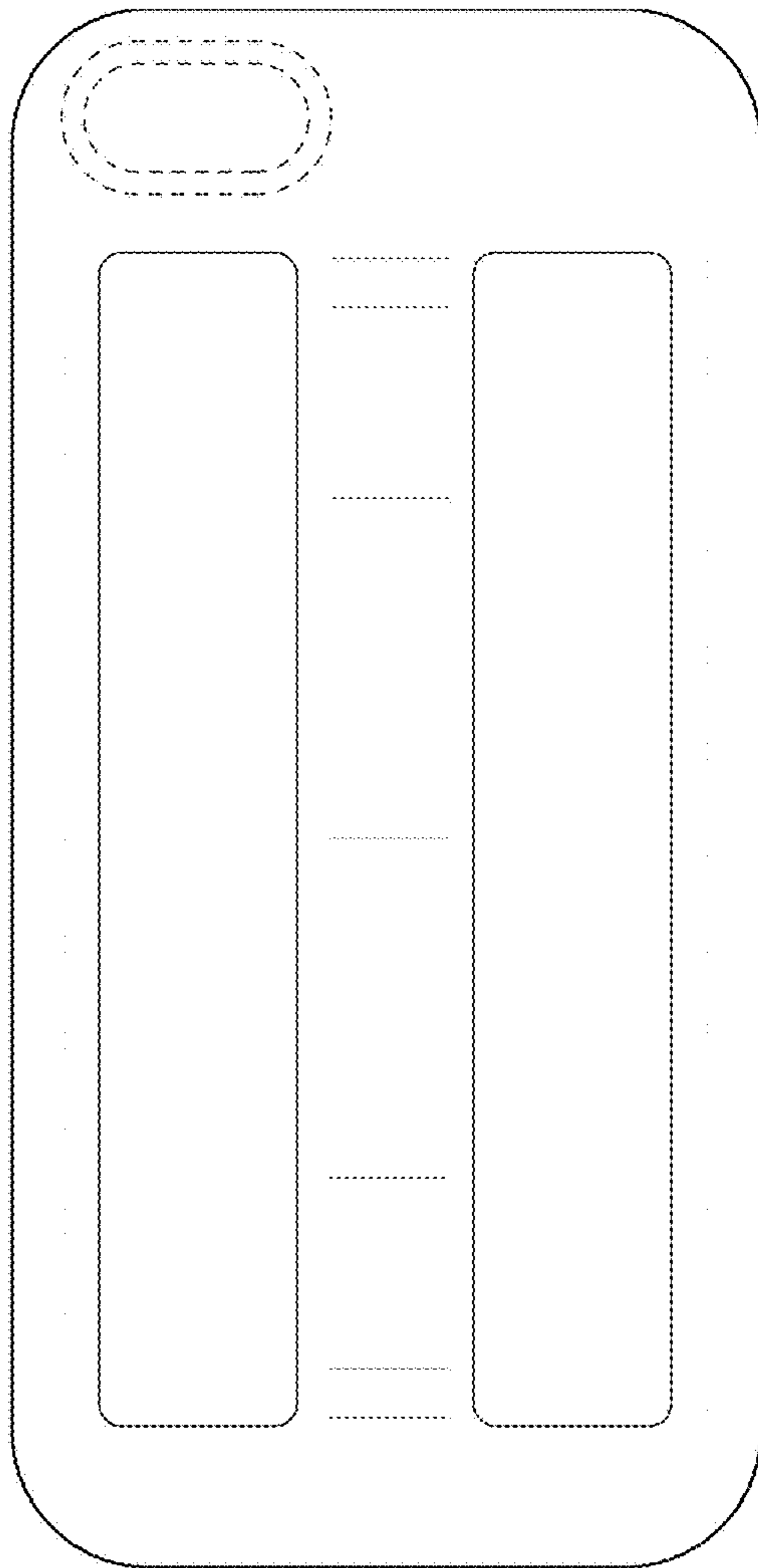

FIG. 11

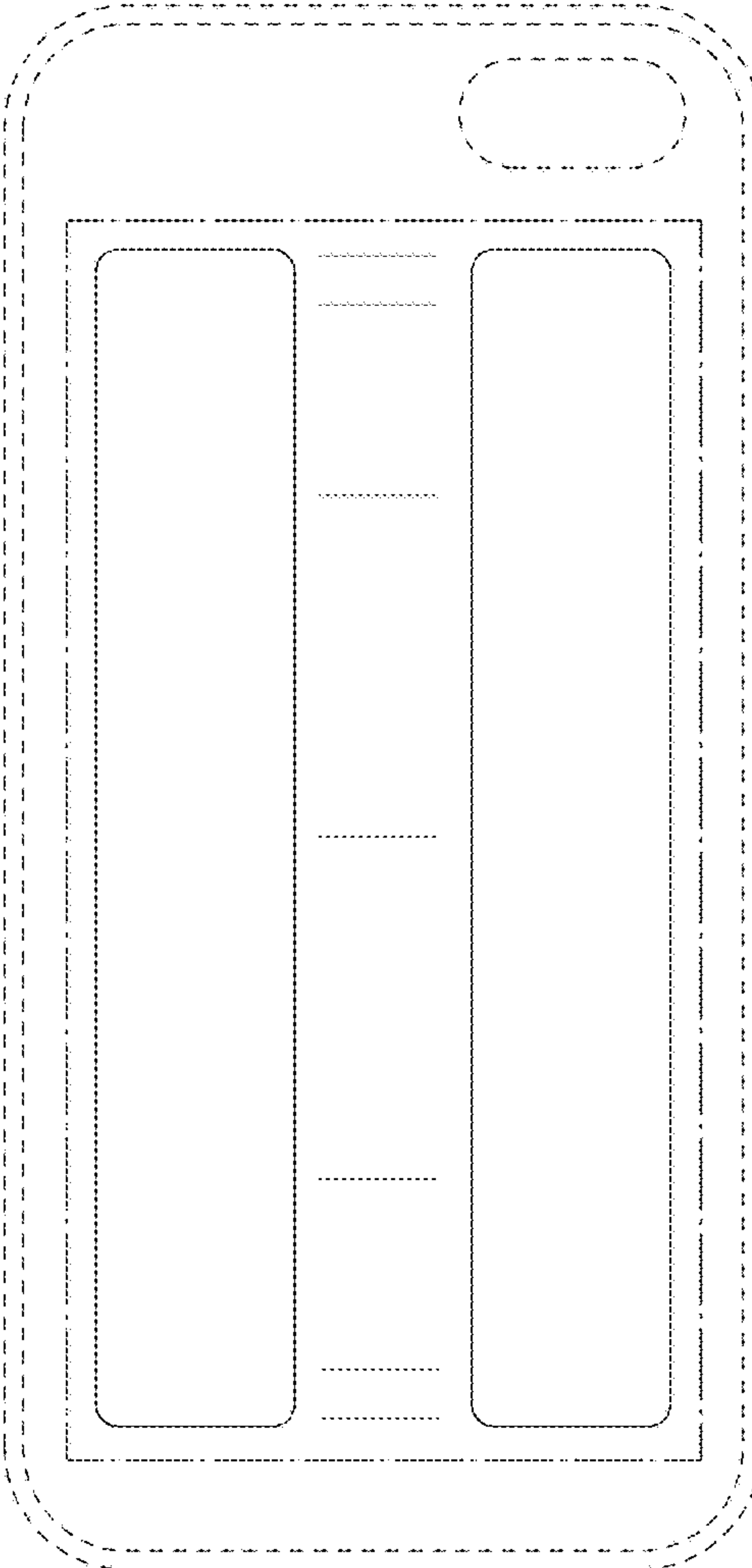

FIG. 12

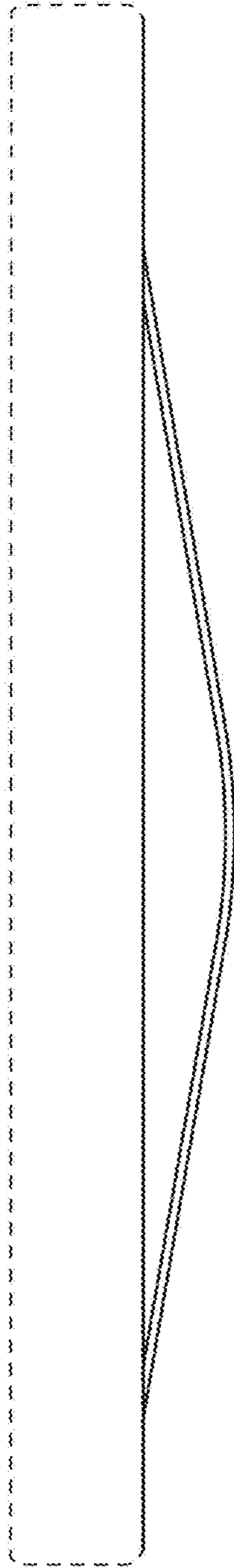

FIG. 13

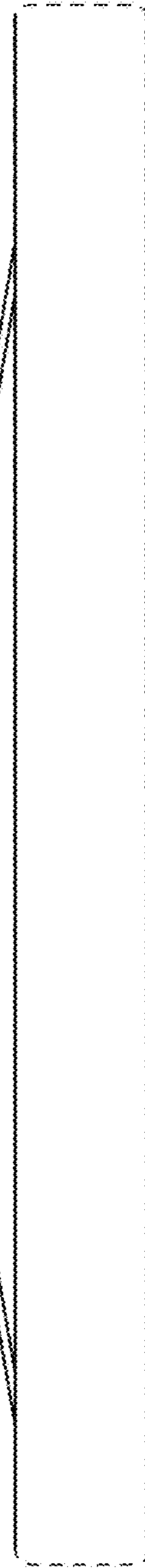

FIG. 14

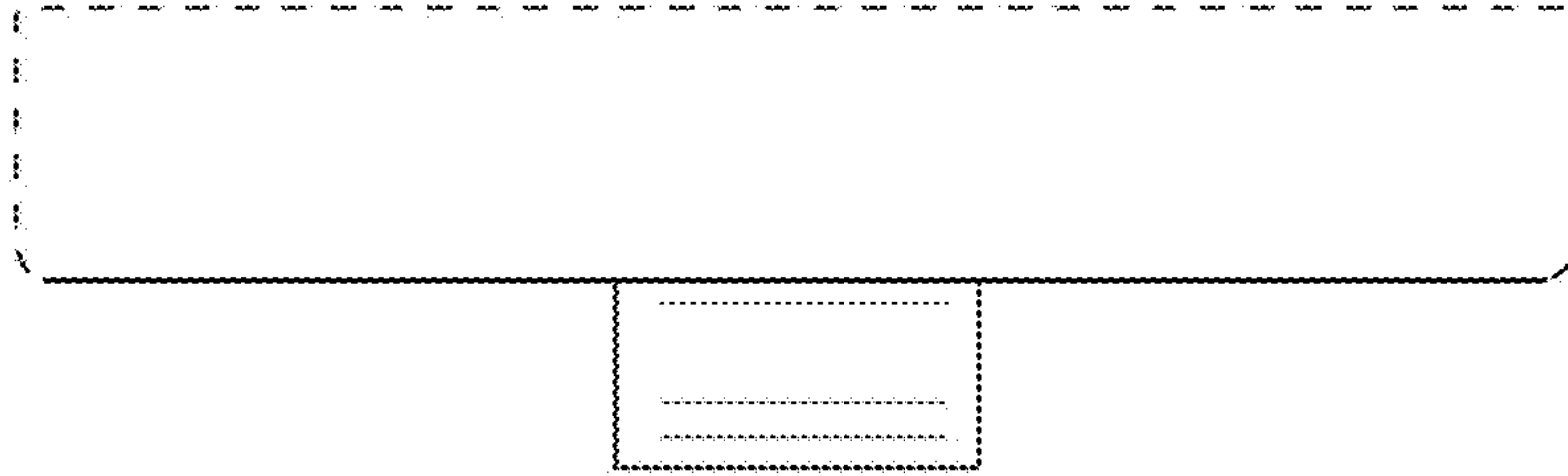

FIG. 15

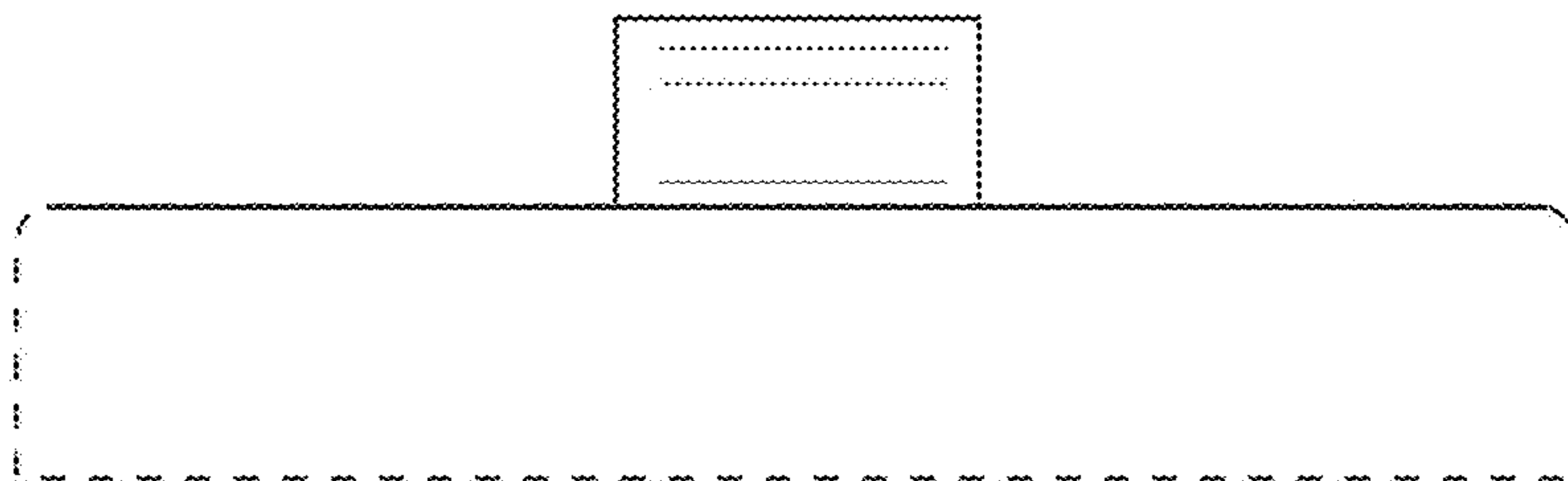

FIG. 16

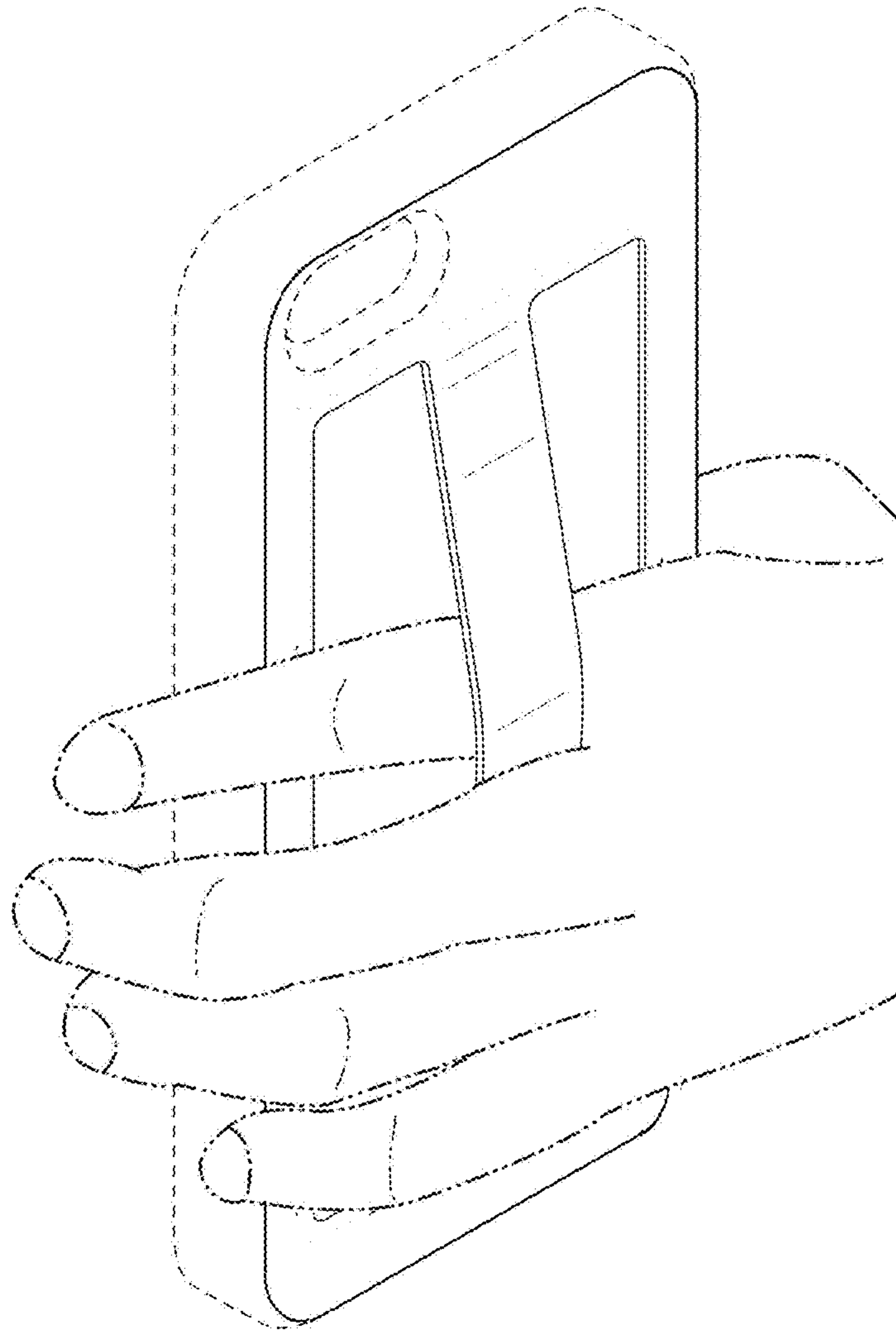

FIG. 17

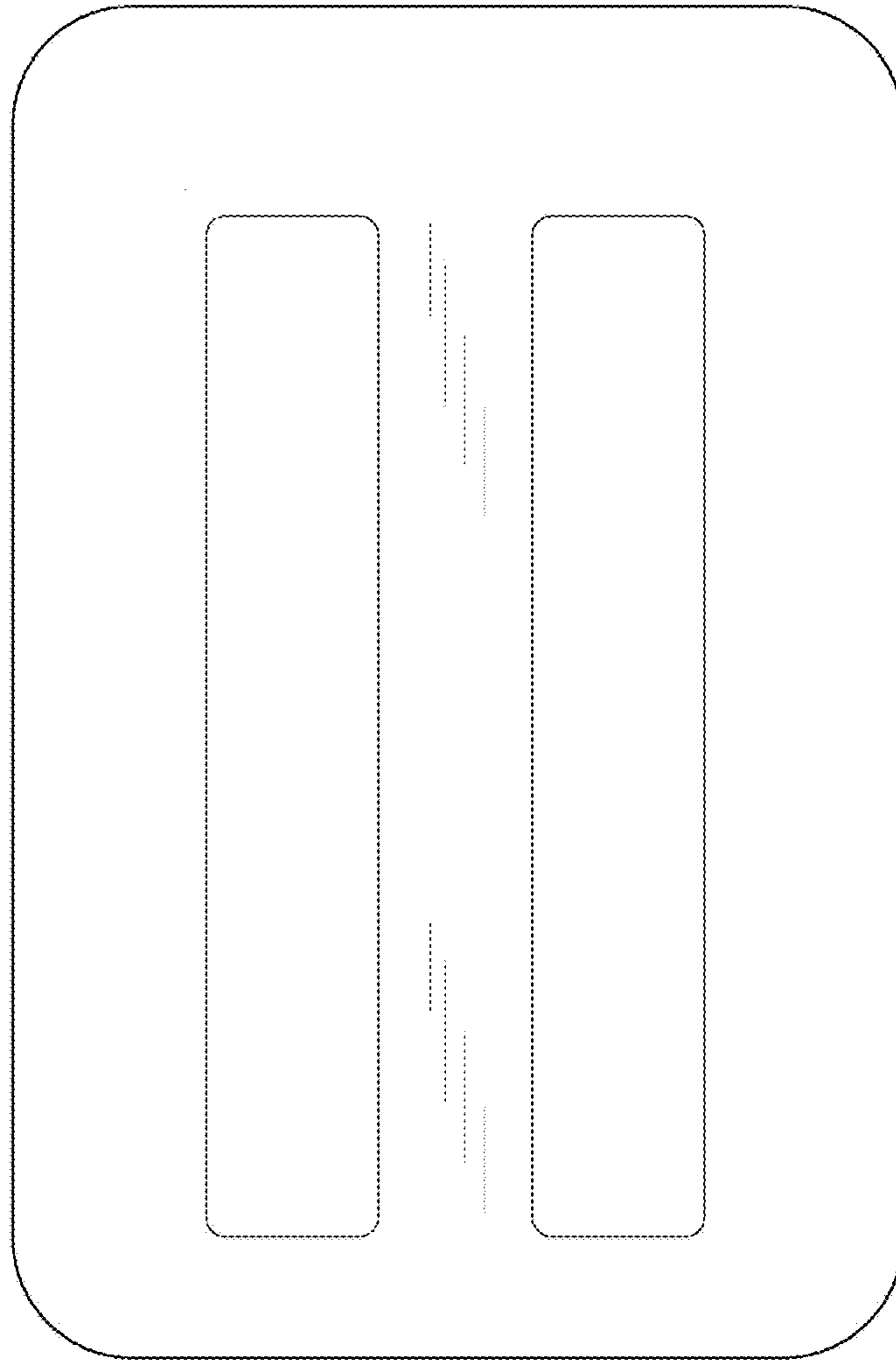

FIG. 18

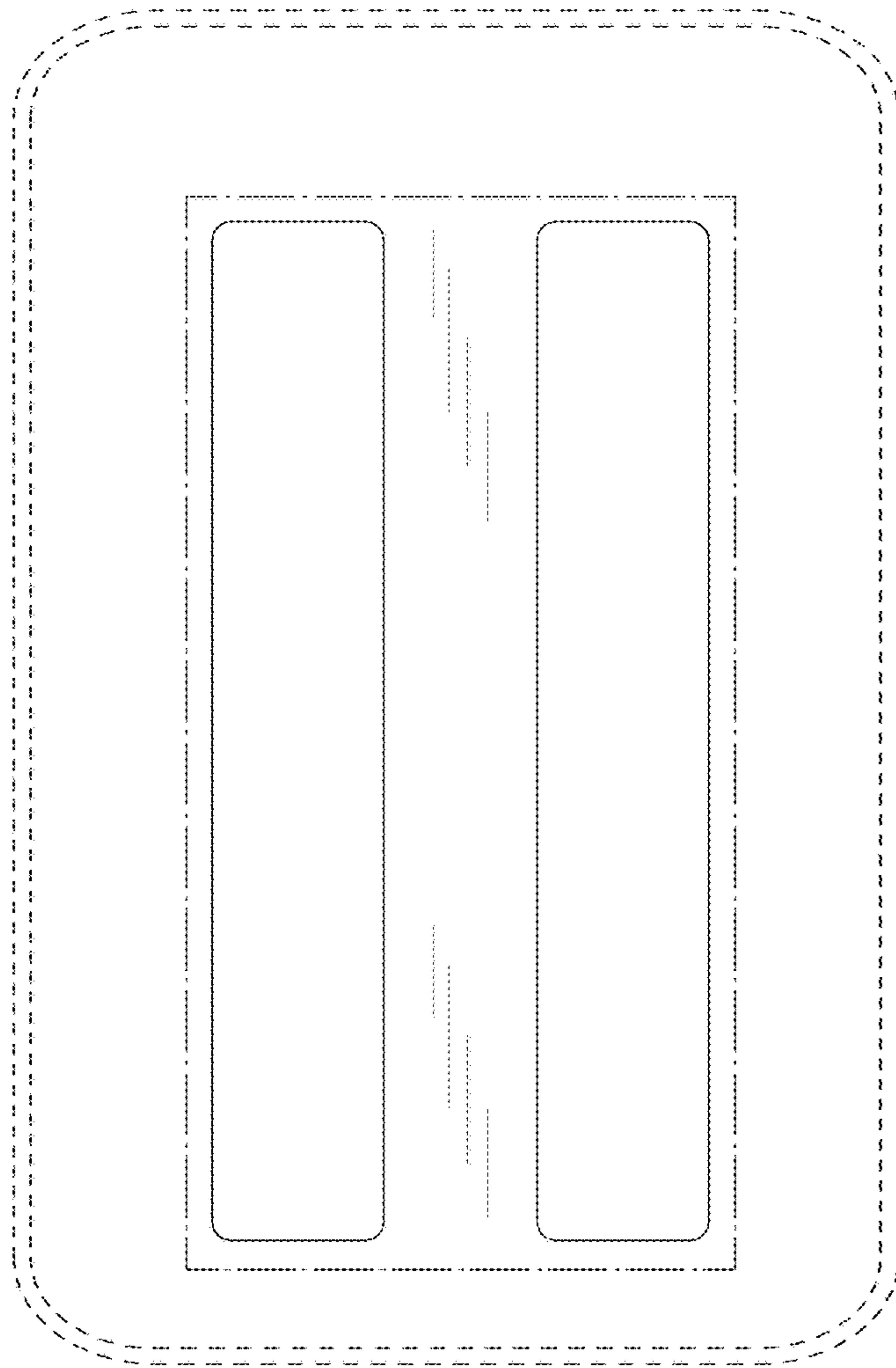

FIG. 19

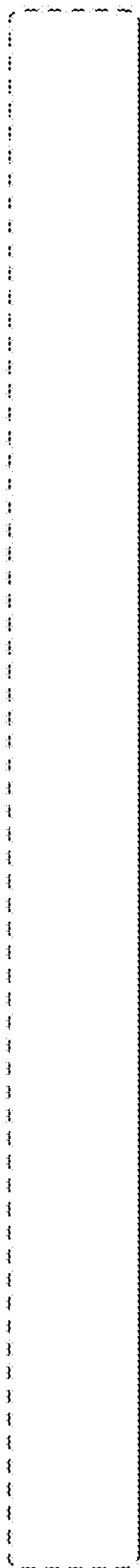

FIG. 20

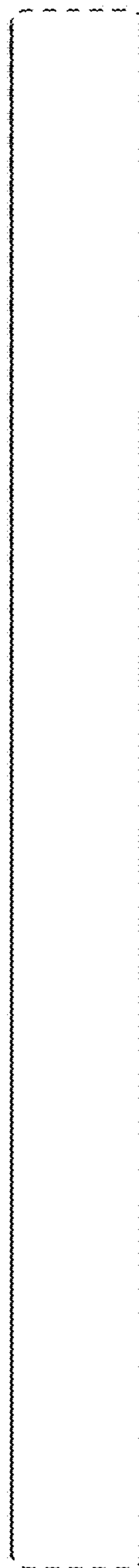

FIG. 21



FIG. 22

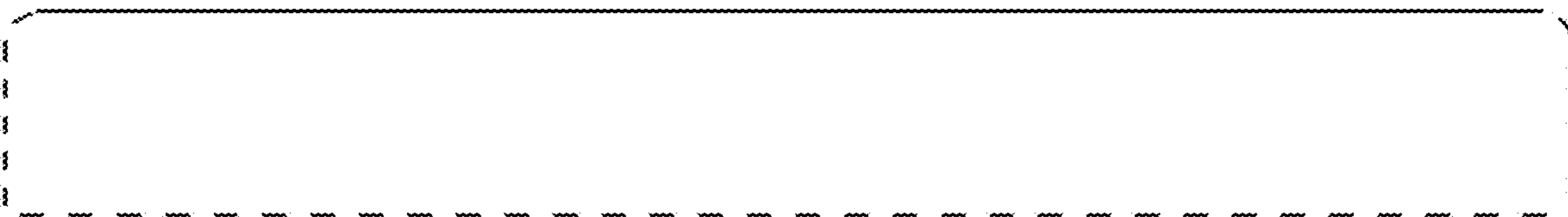

FIG. 23

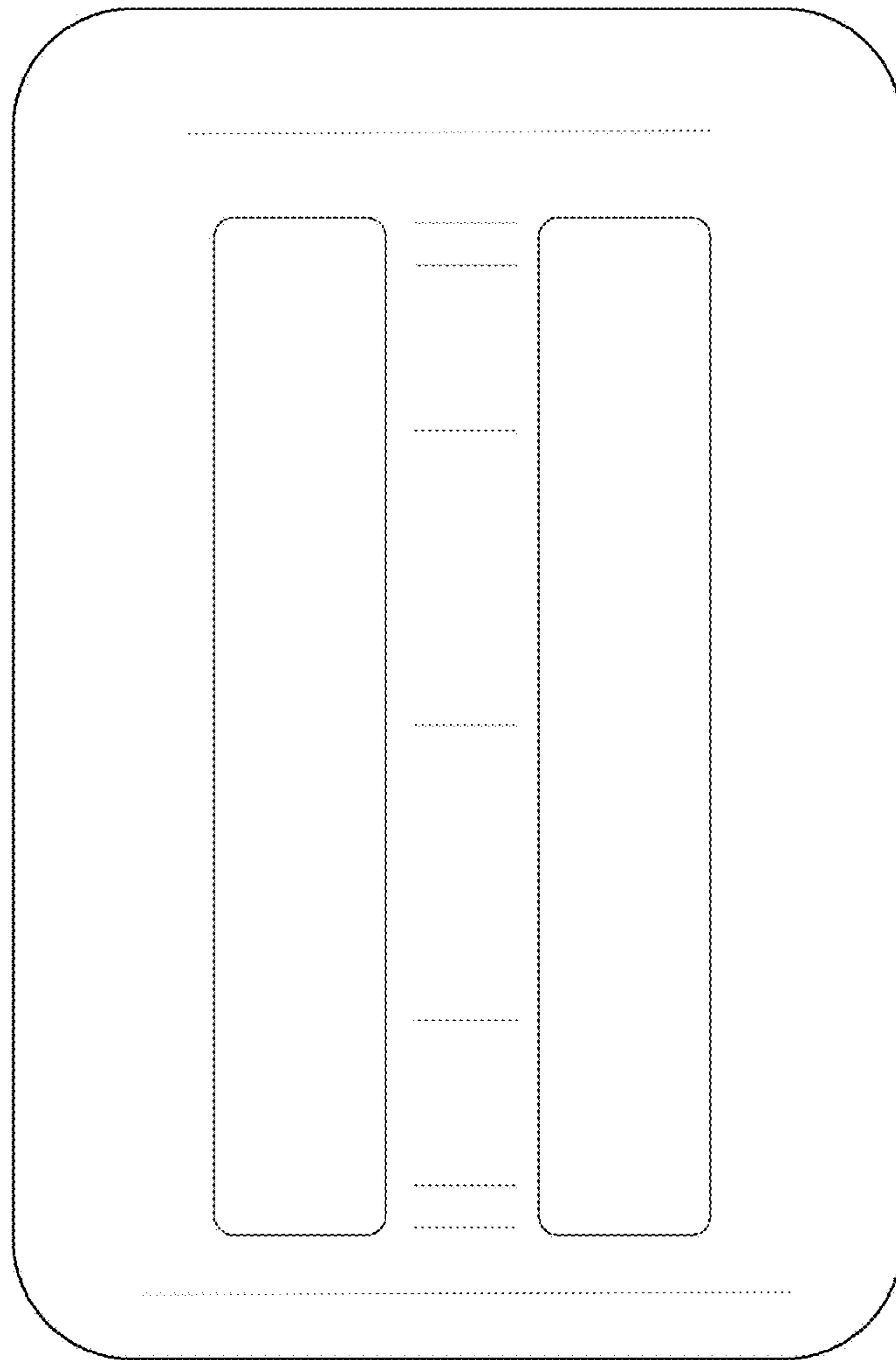

FIG. 24

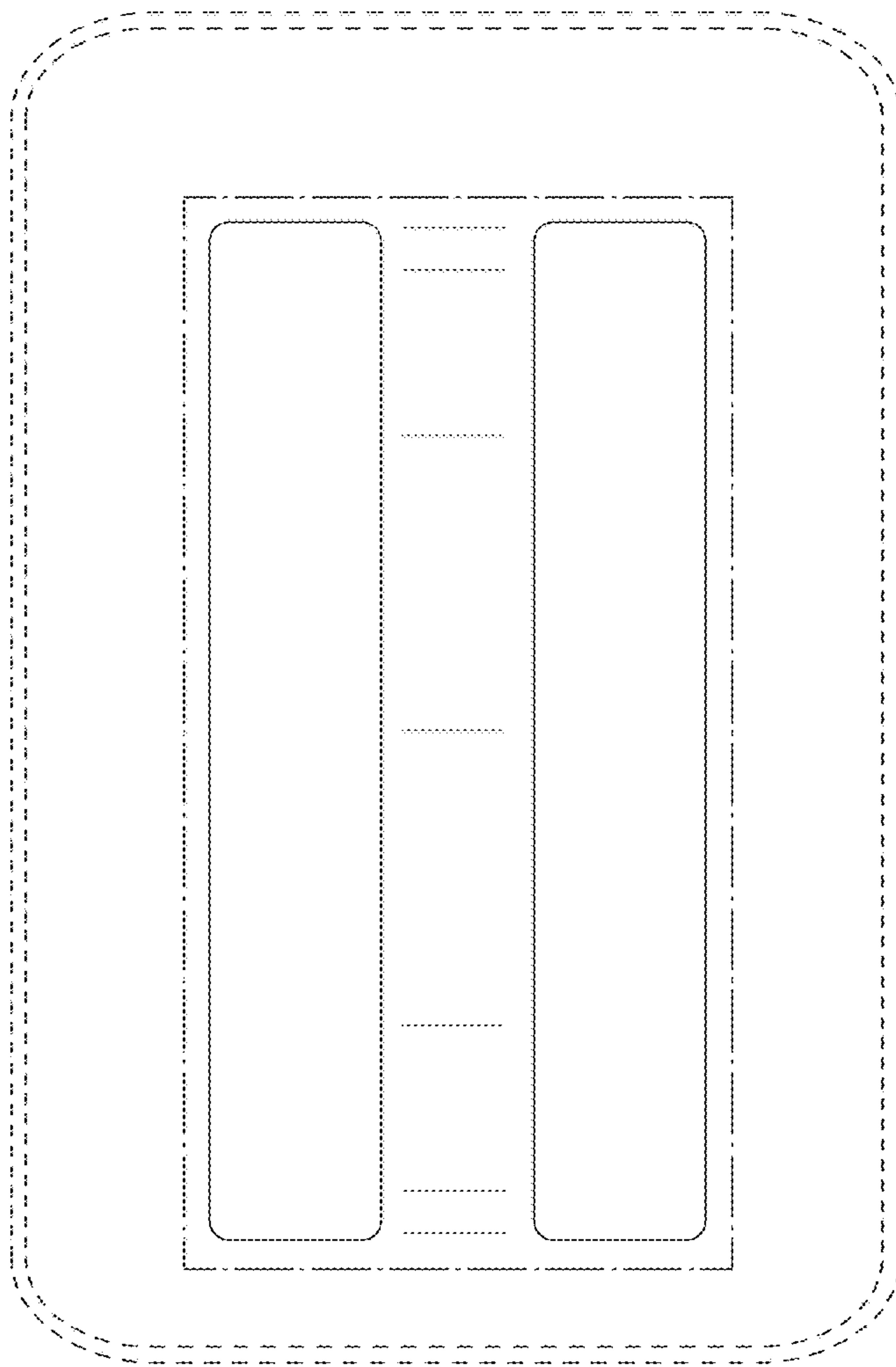

FIG. 25

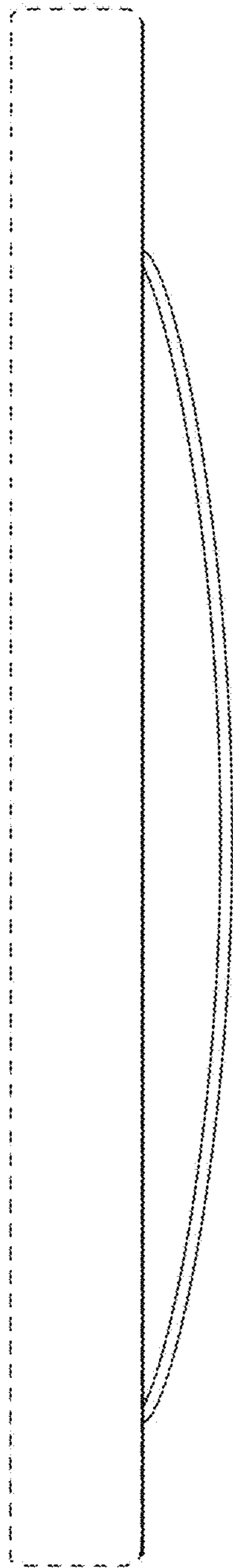

FIG. 26

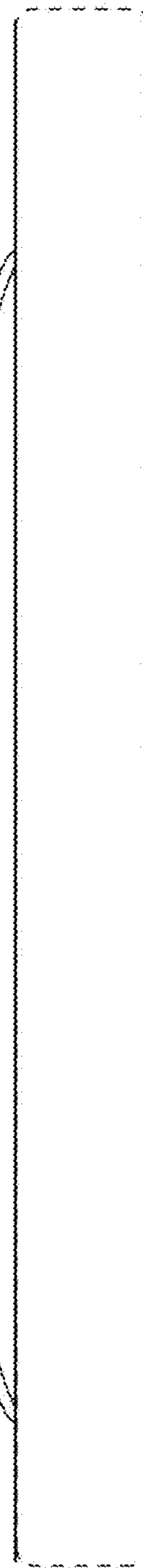

FIG. 27

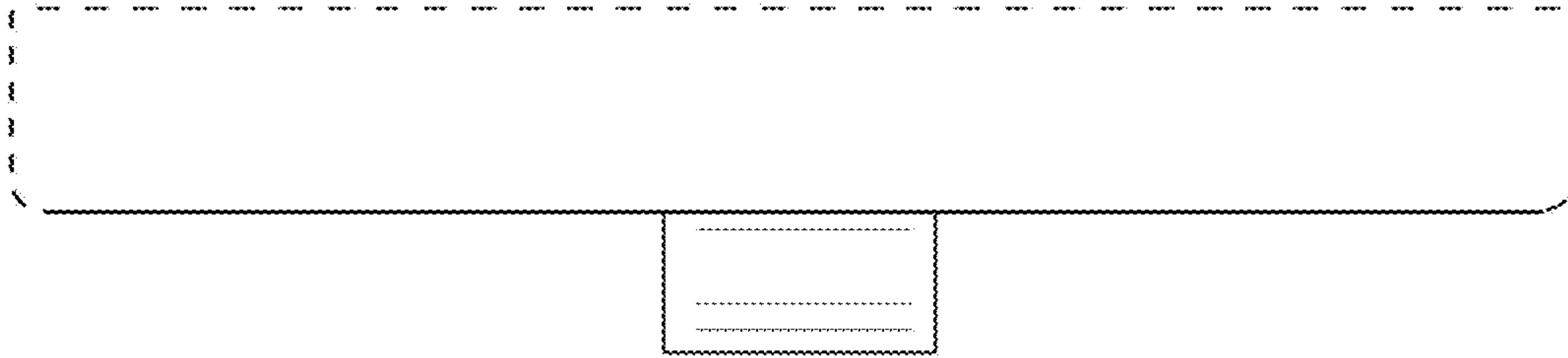

FIG. 28

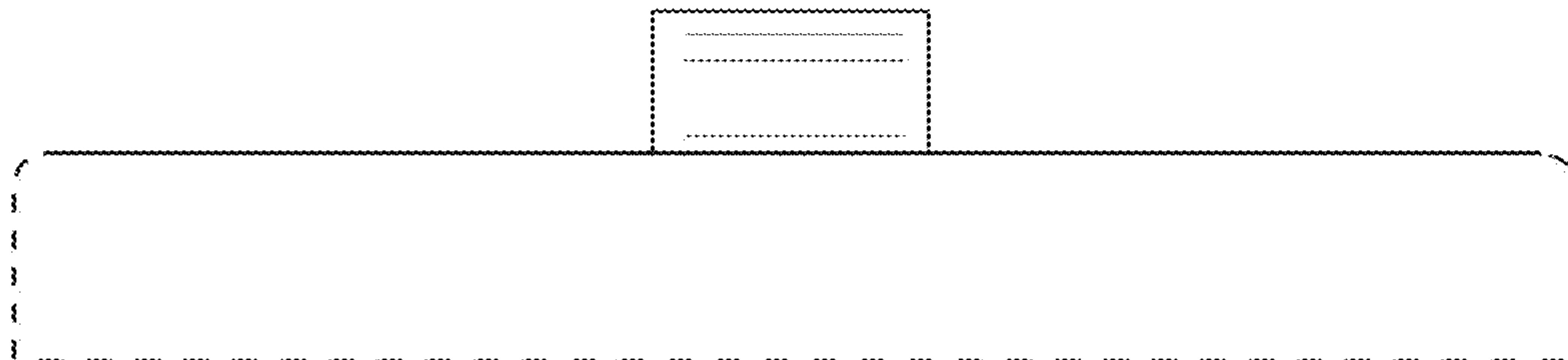

FIG. 29

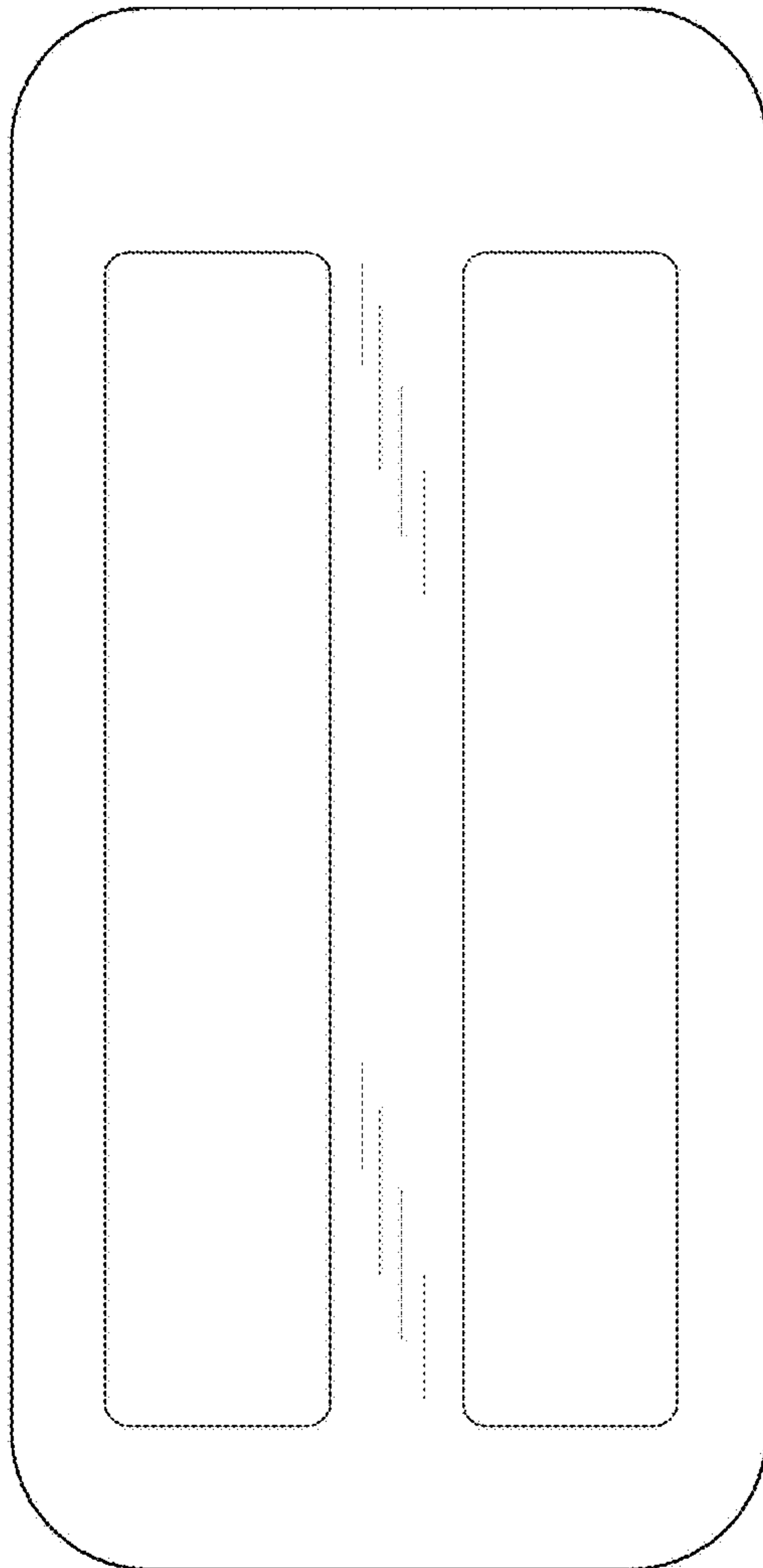

FIG. 30

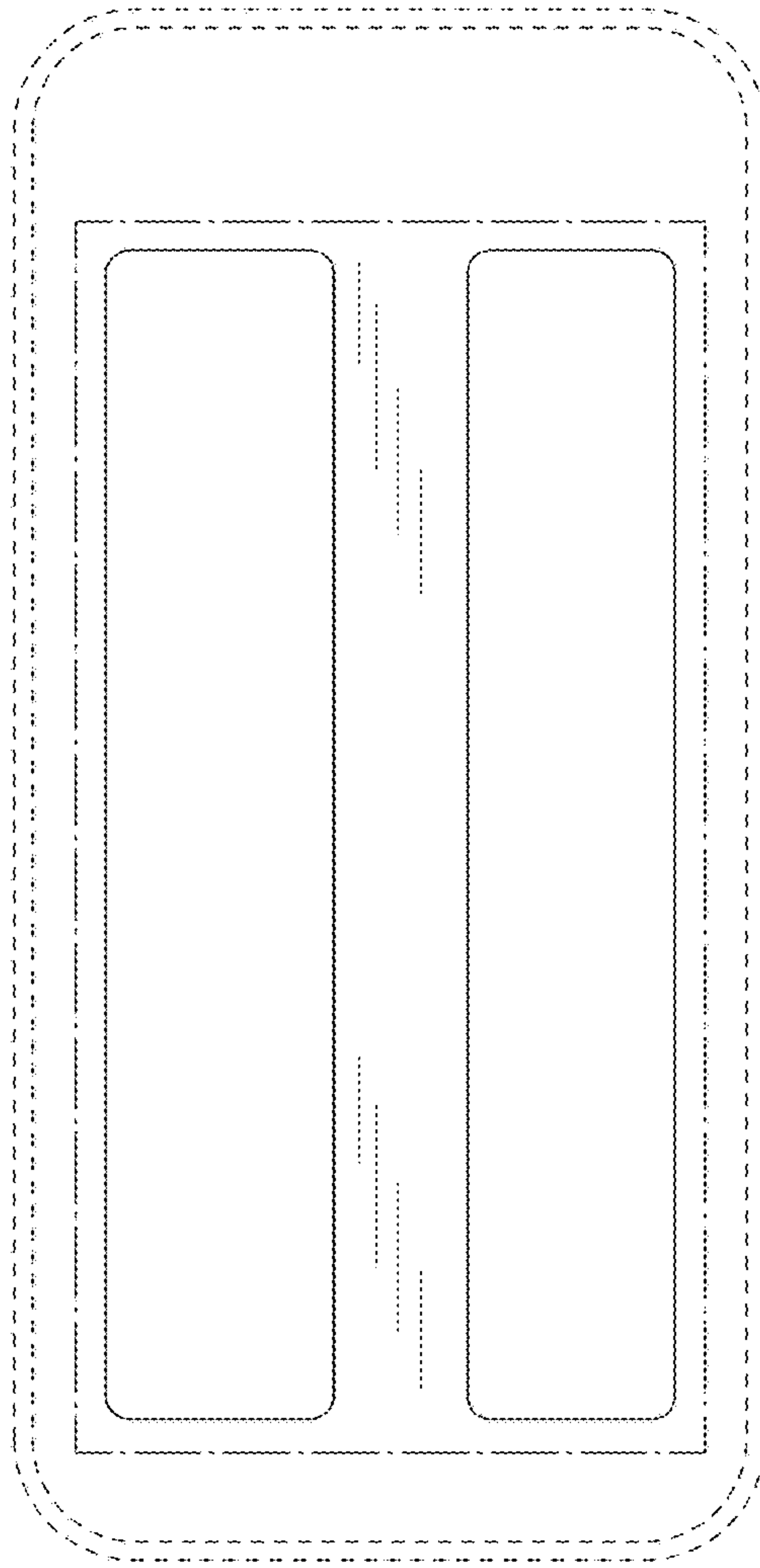

FIG. 31

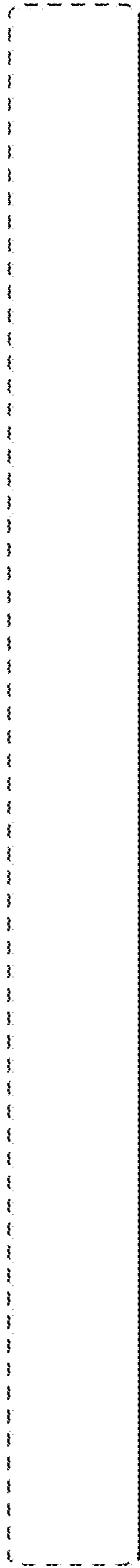

FIG. 32

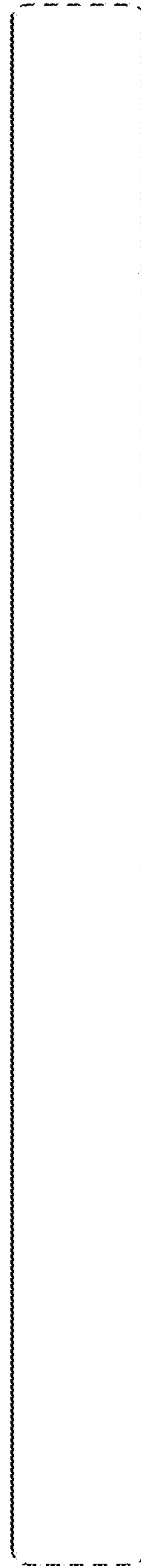

FIG. 33

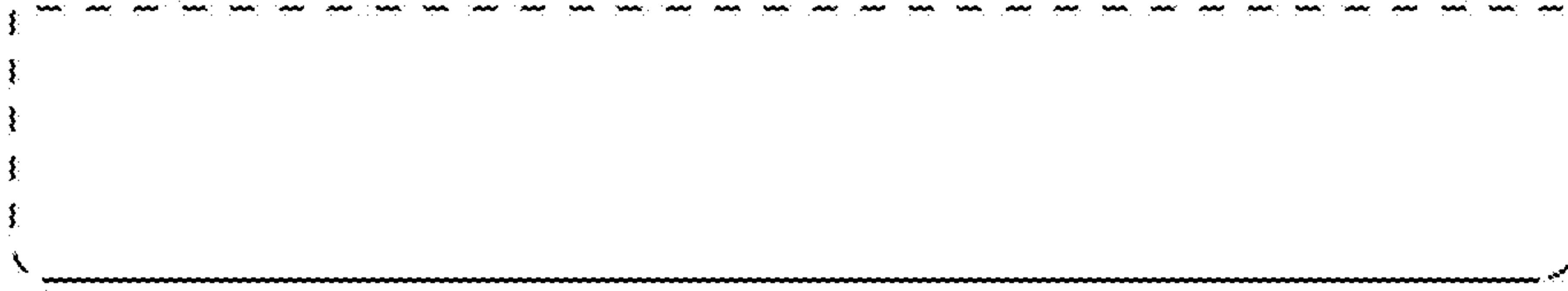

FIG. 34

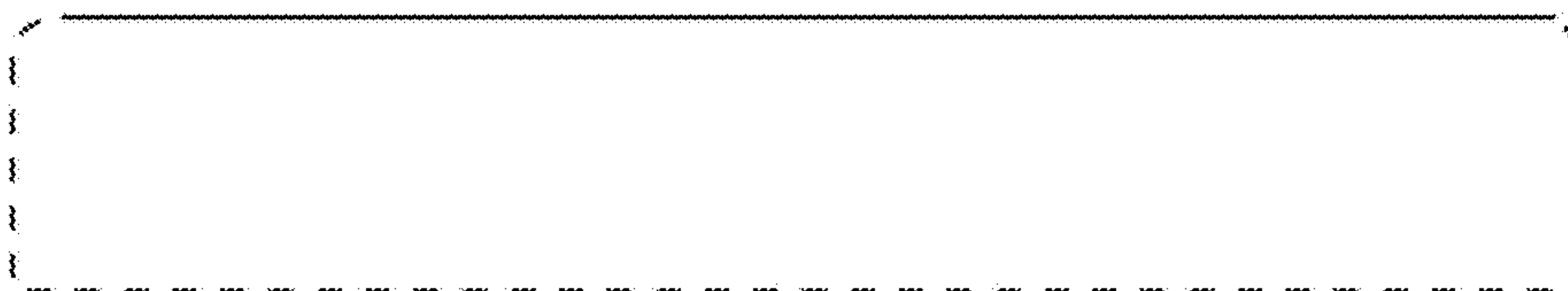

FIG. 35

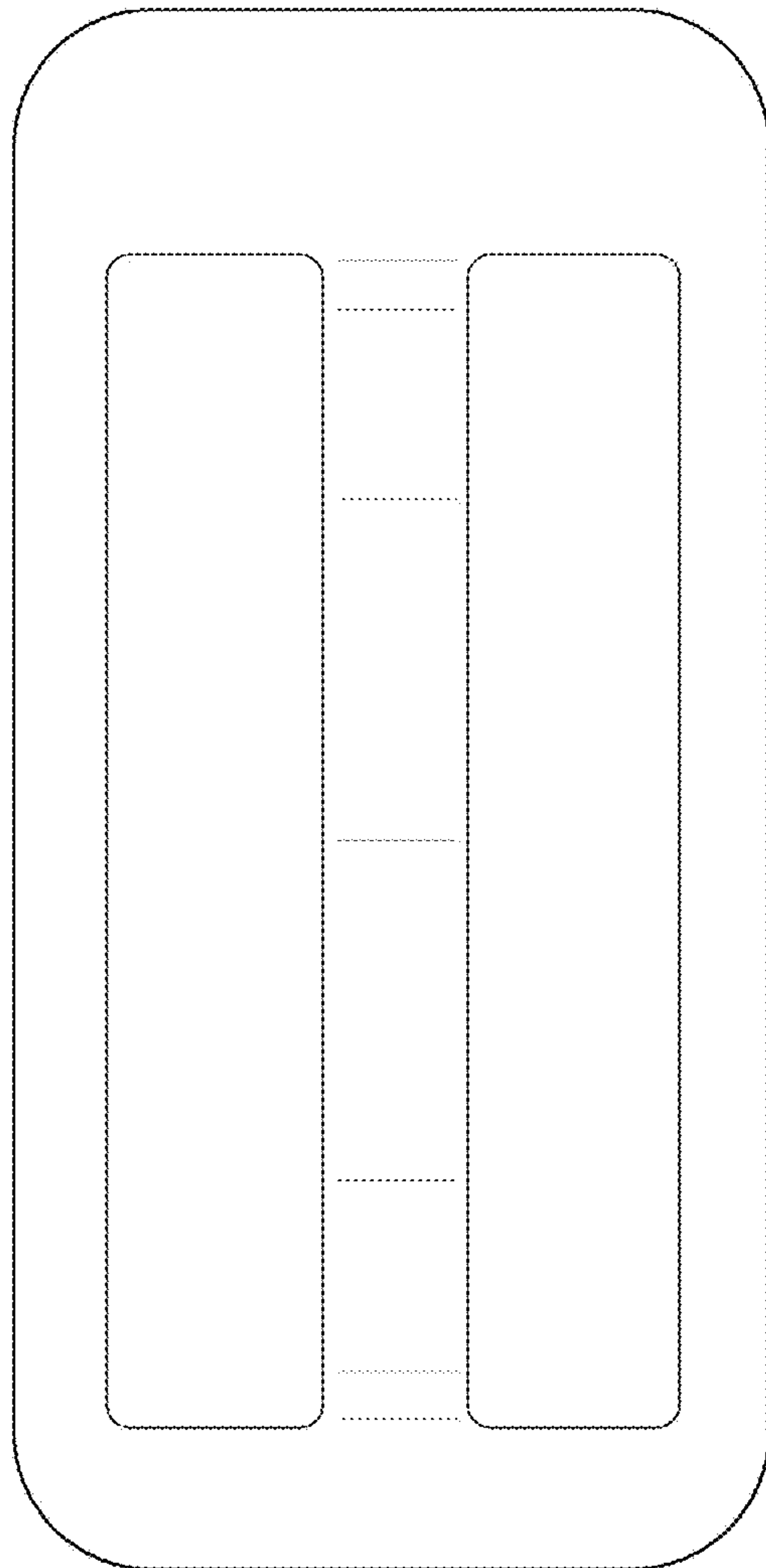

FIG. 36

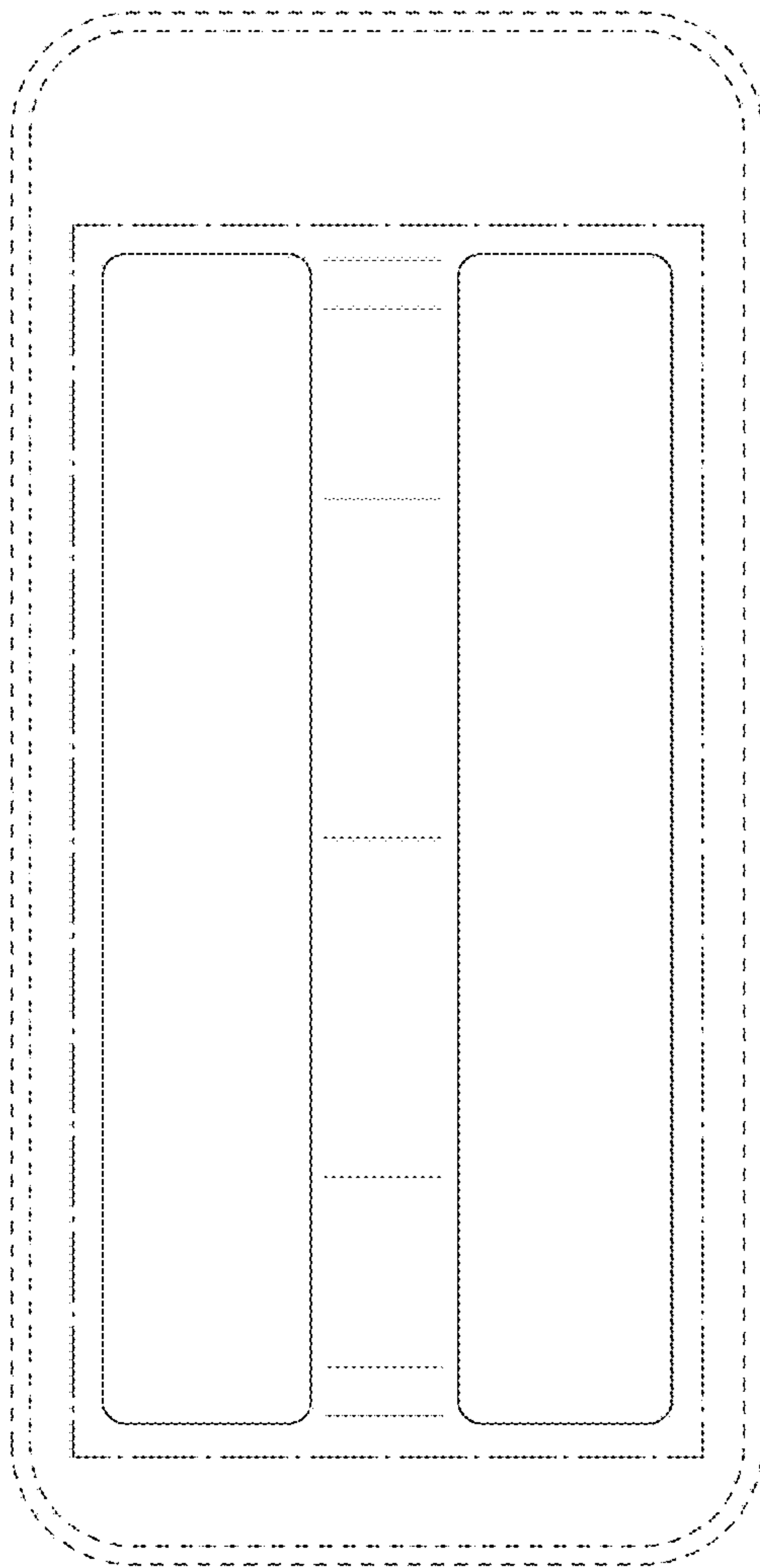

FIG. 37

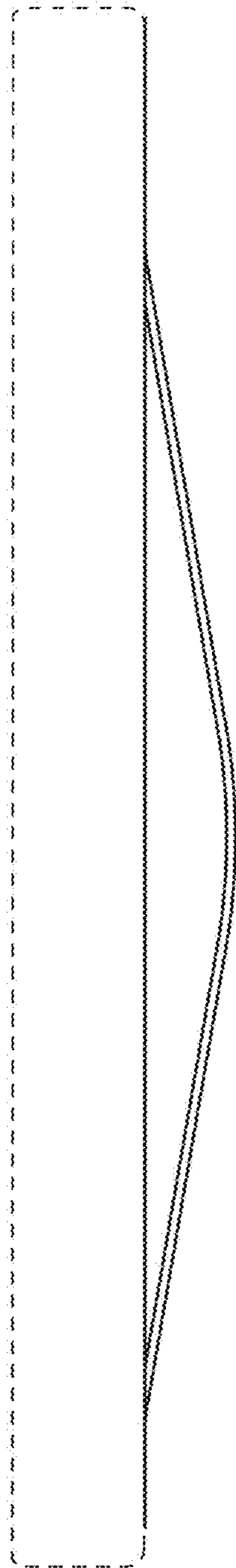

FIG. 38

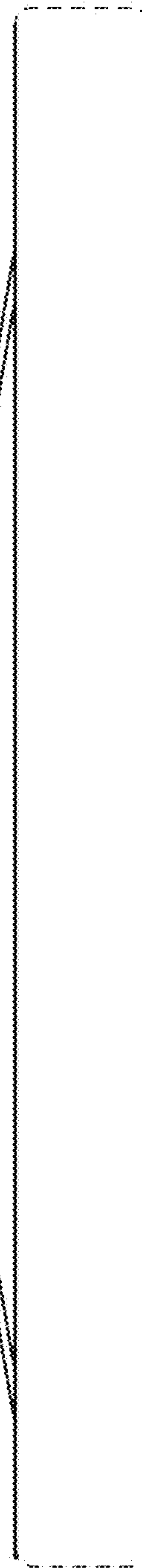

FIG. 39

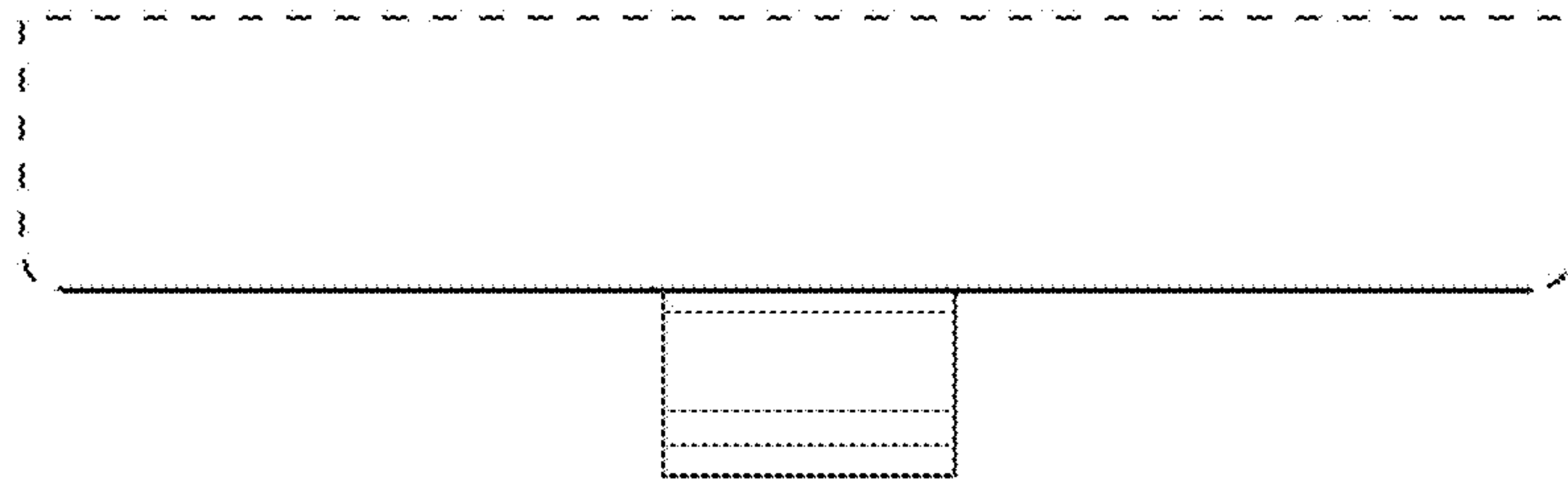

FIG. 40

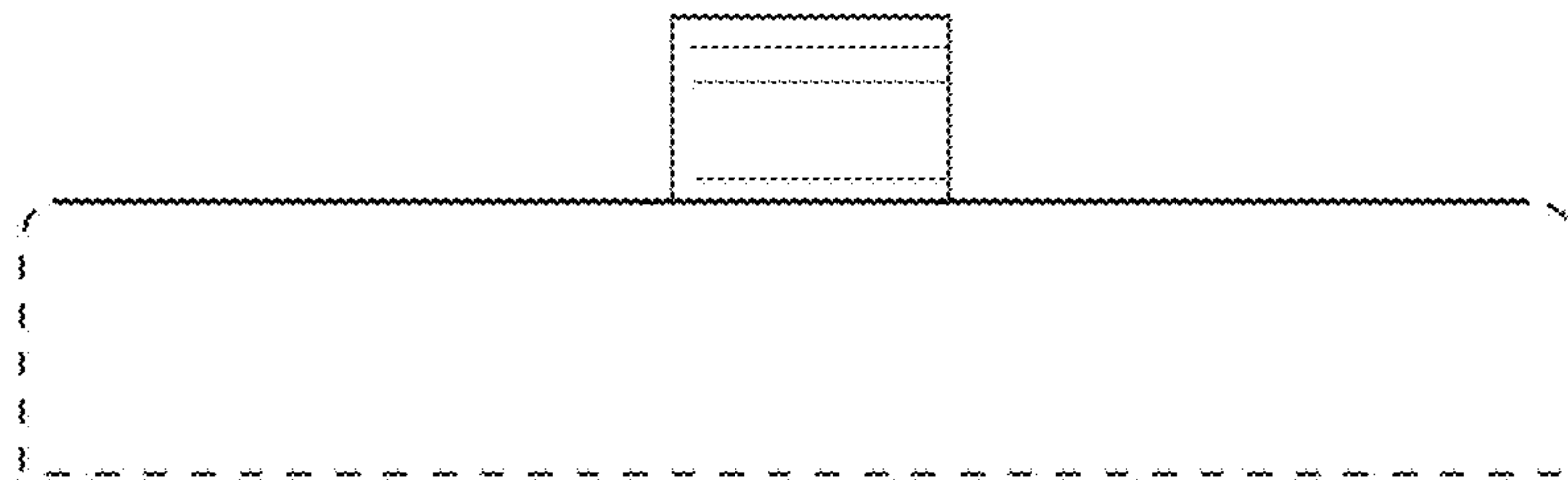

FIG. 41

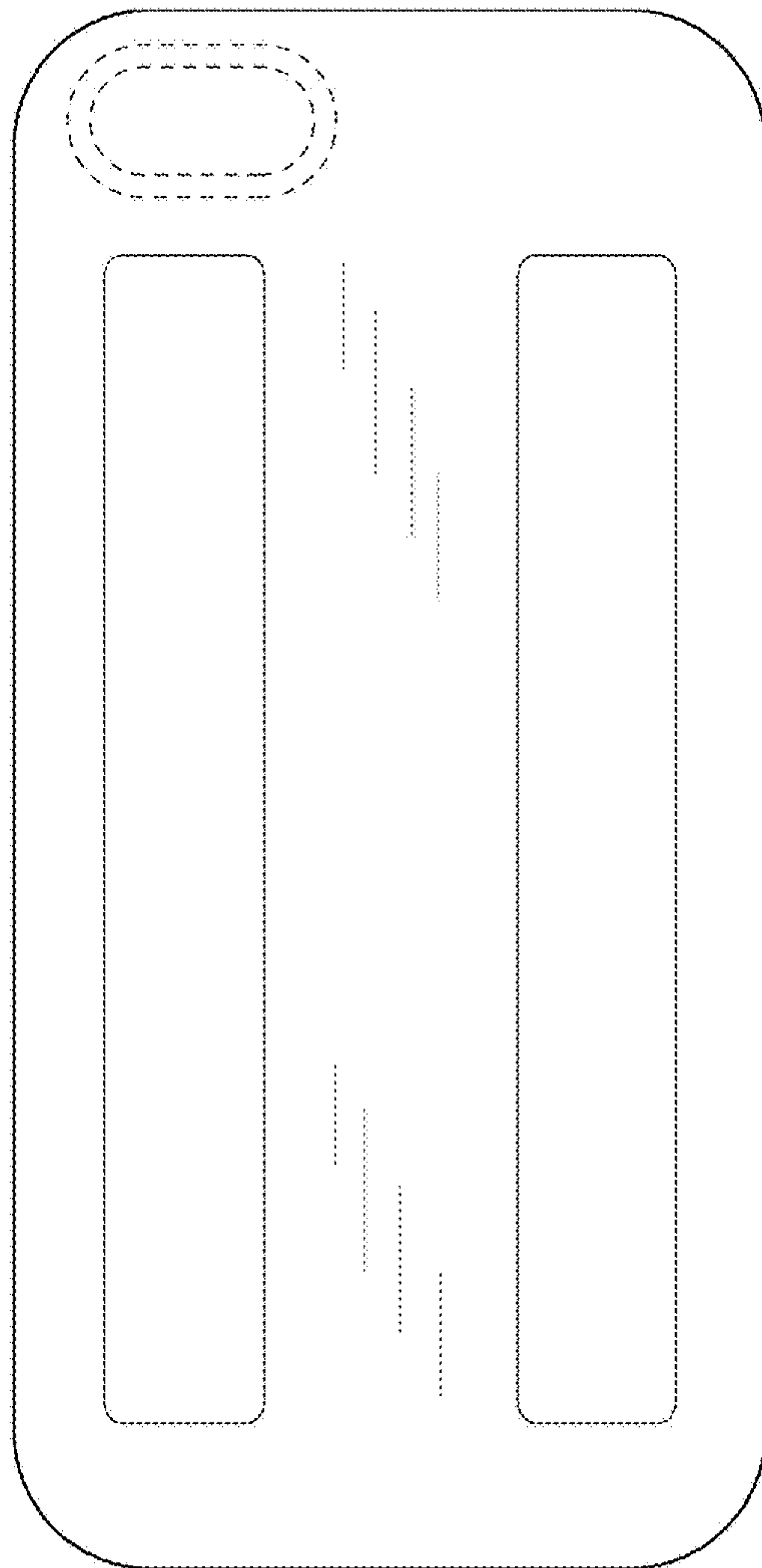

FIG. 42

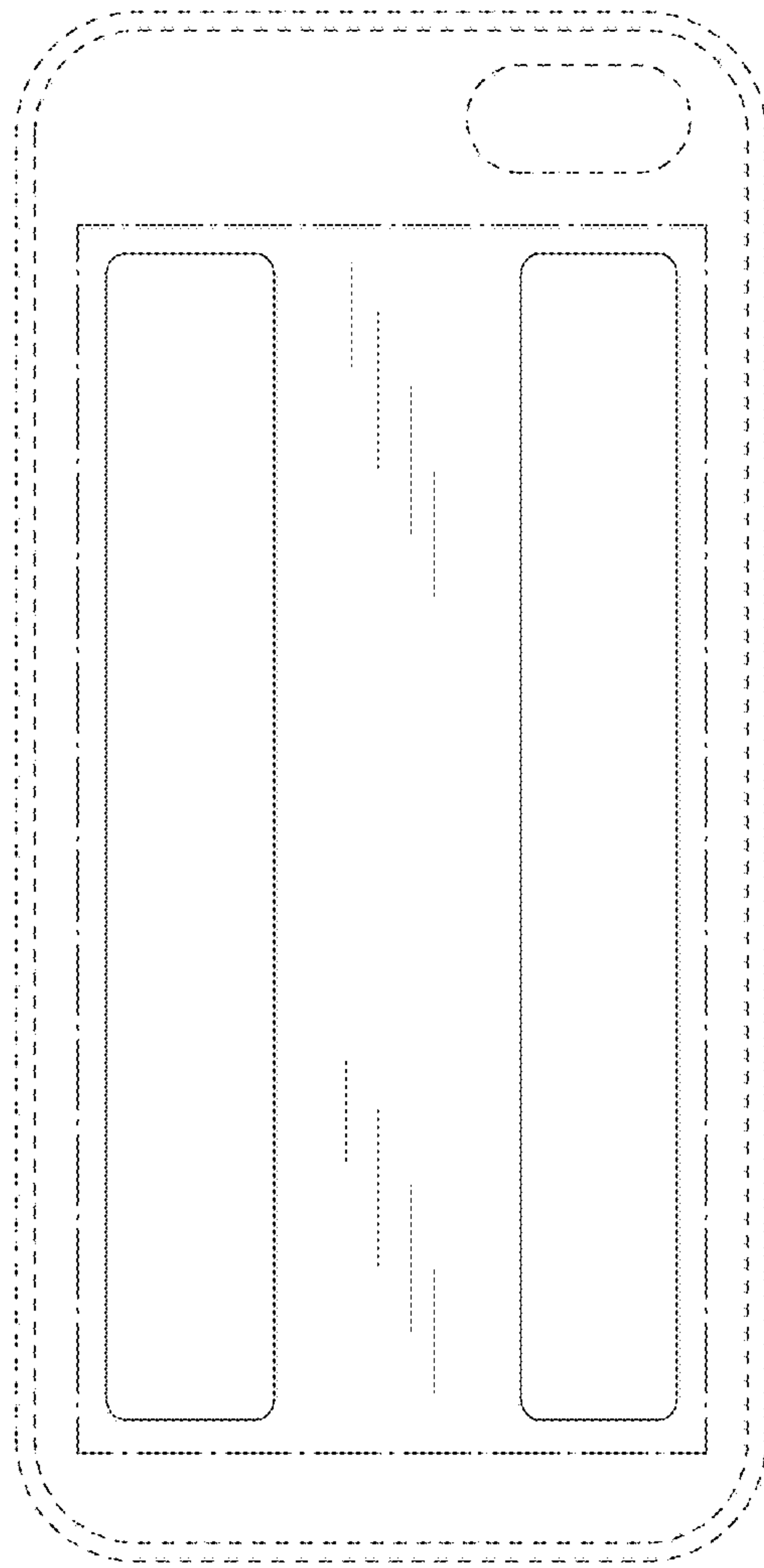

FIG. 43

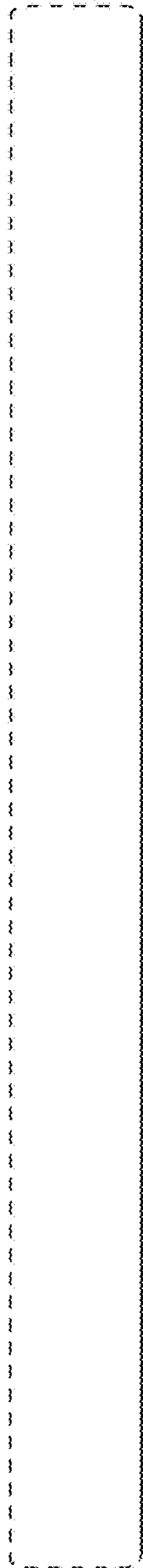

FIG. 44

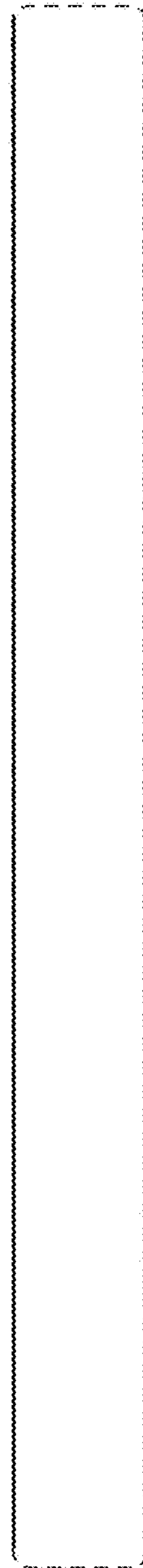

FIG. 45

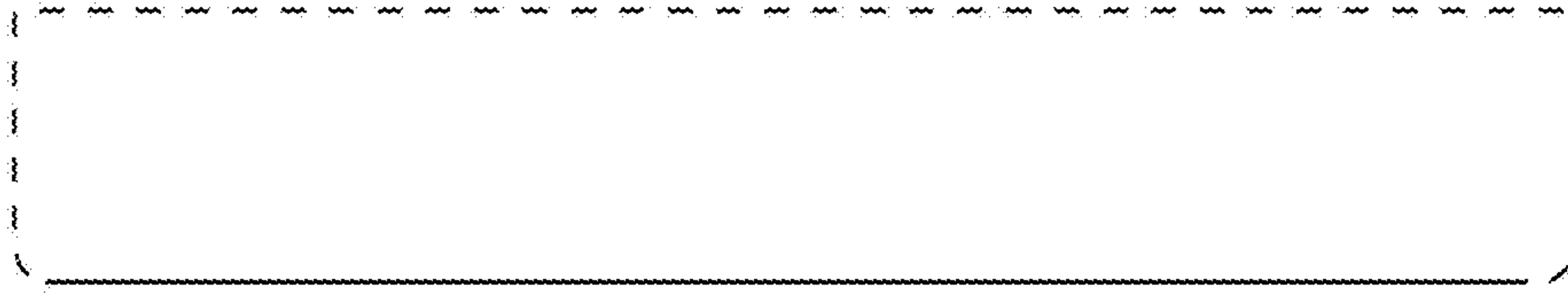

FIG. 46



FIG. 47

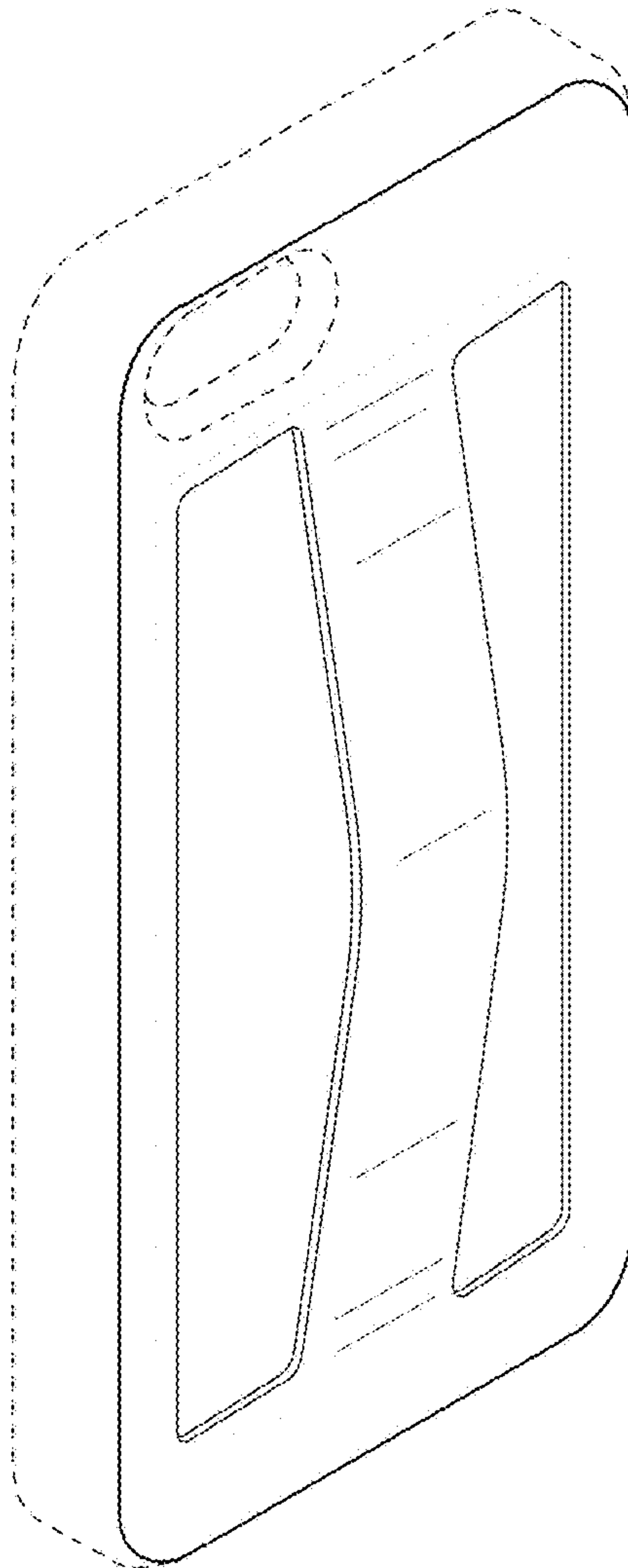

FIG. 48

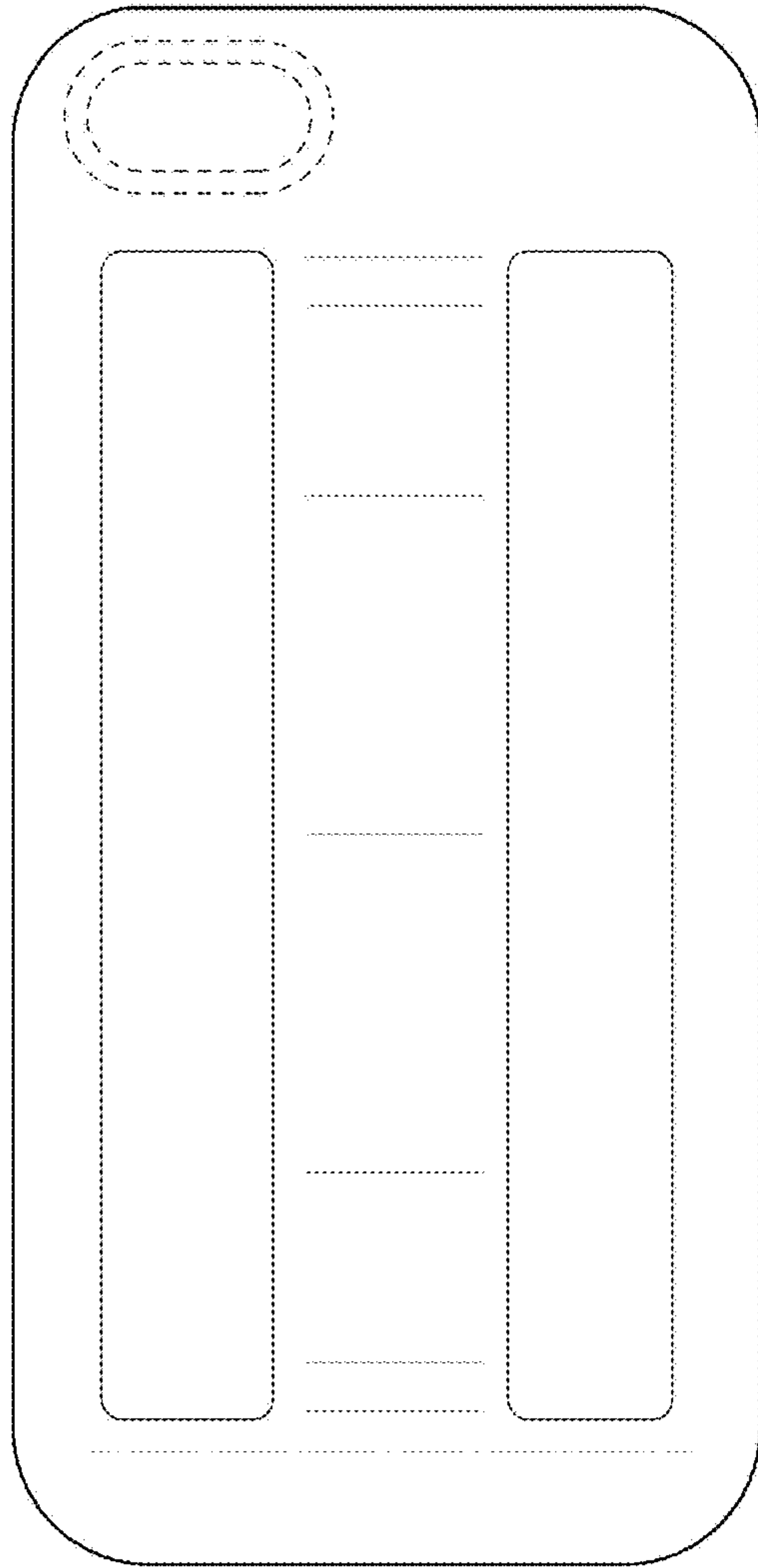

FIG. 49

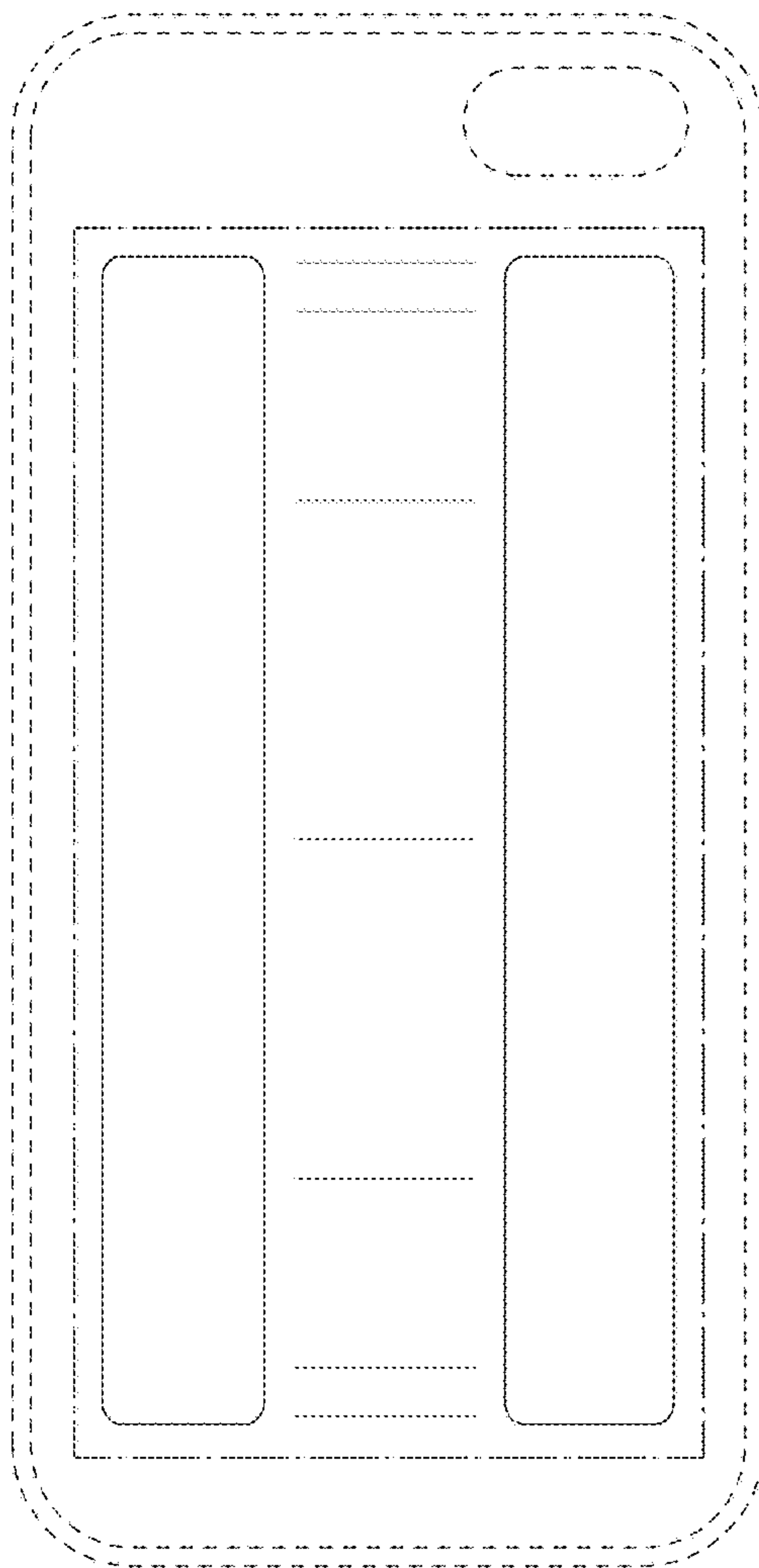

FIG. 50

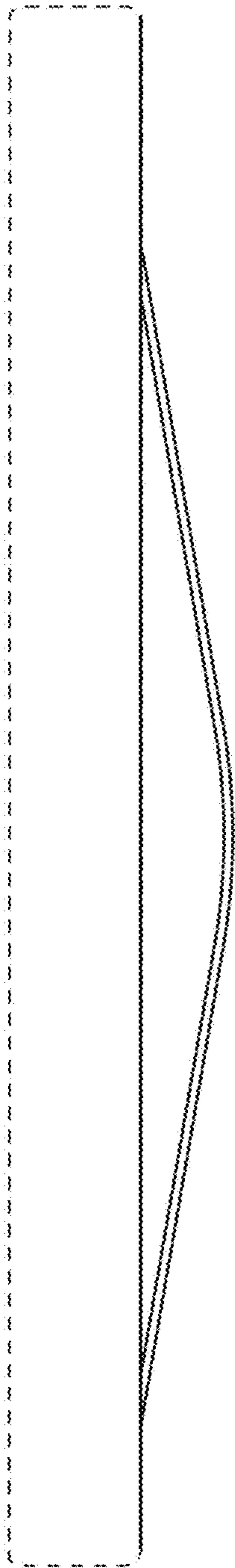

FIG. 51



FIG. 52

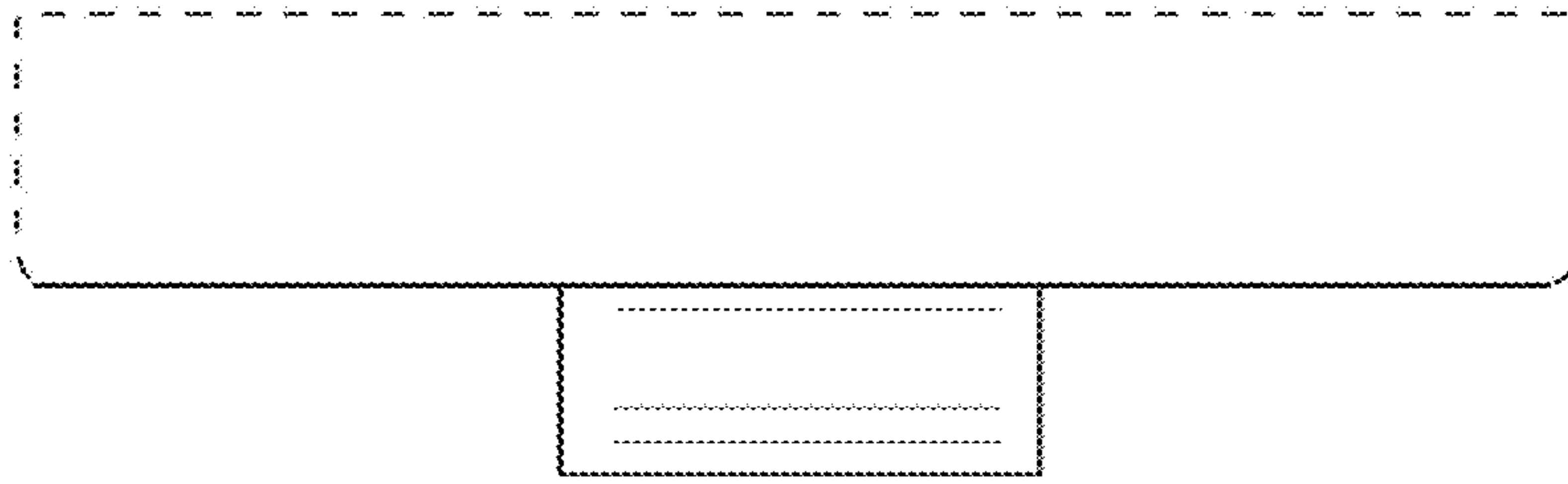

FIG. 53

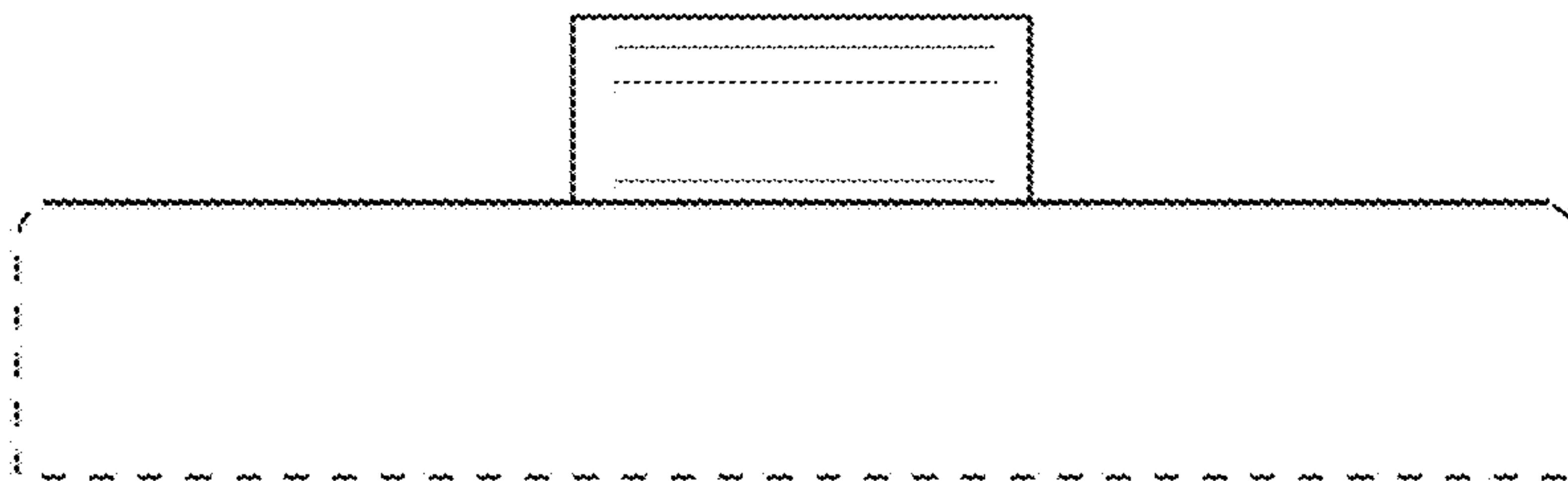

FIG. 54

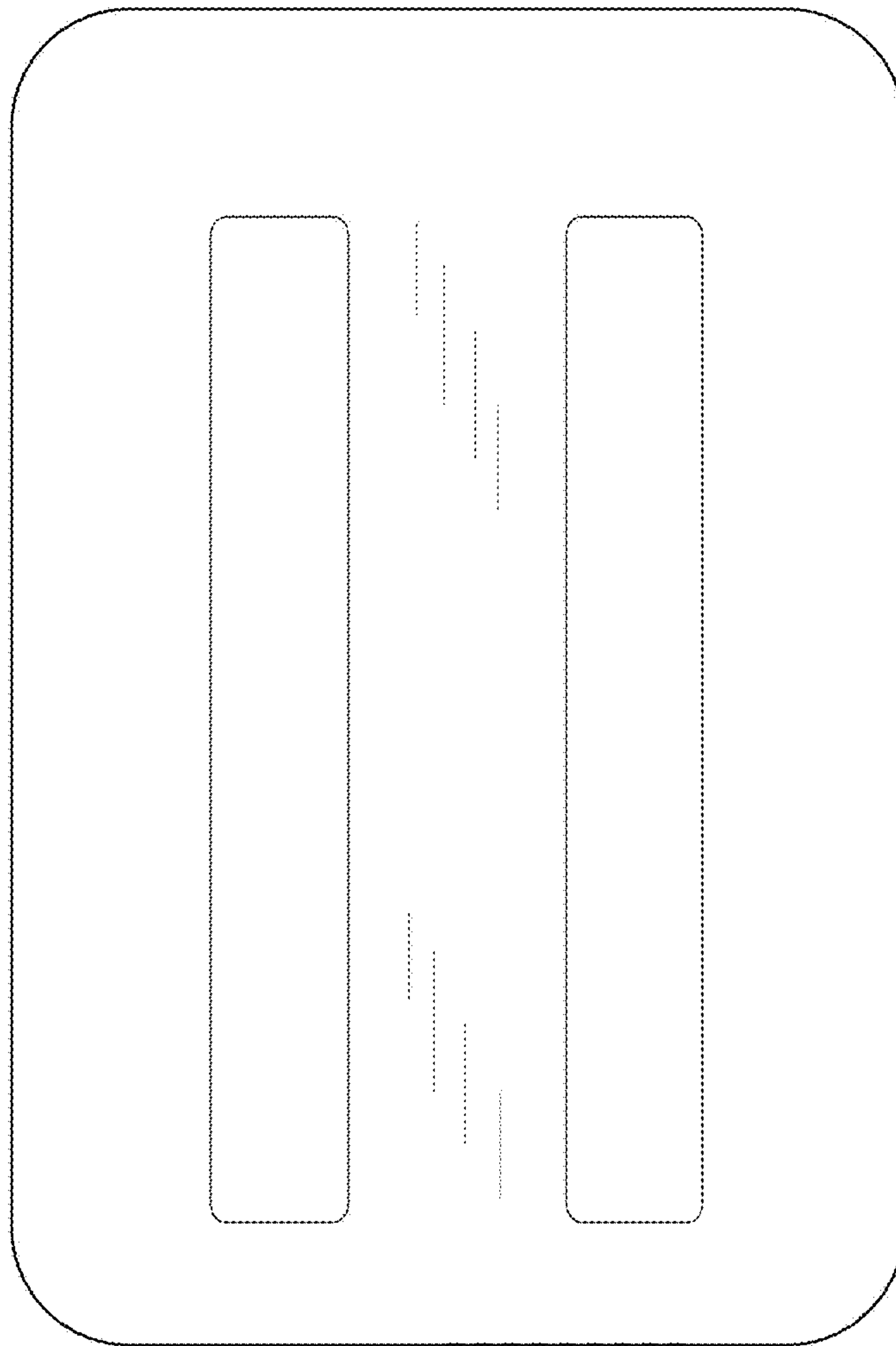

FIG. 55

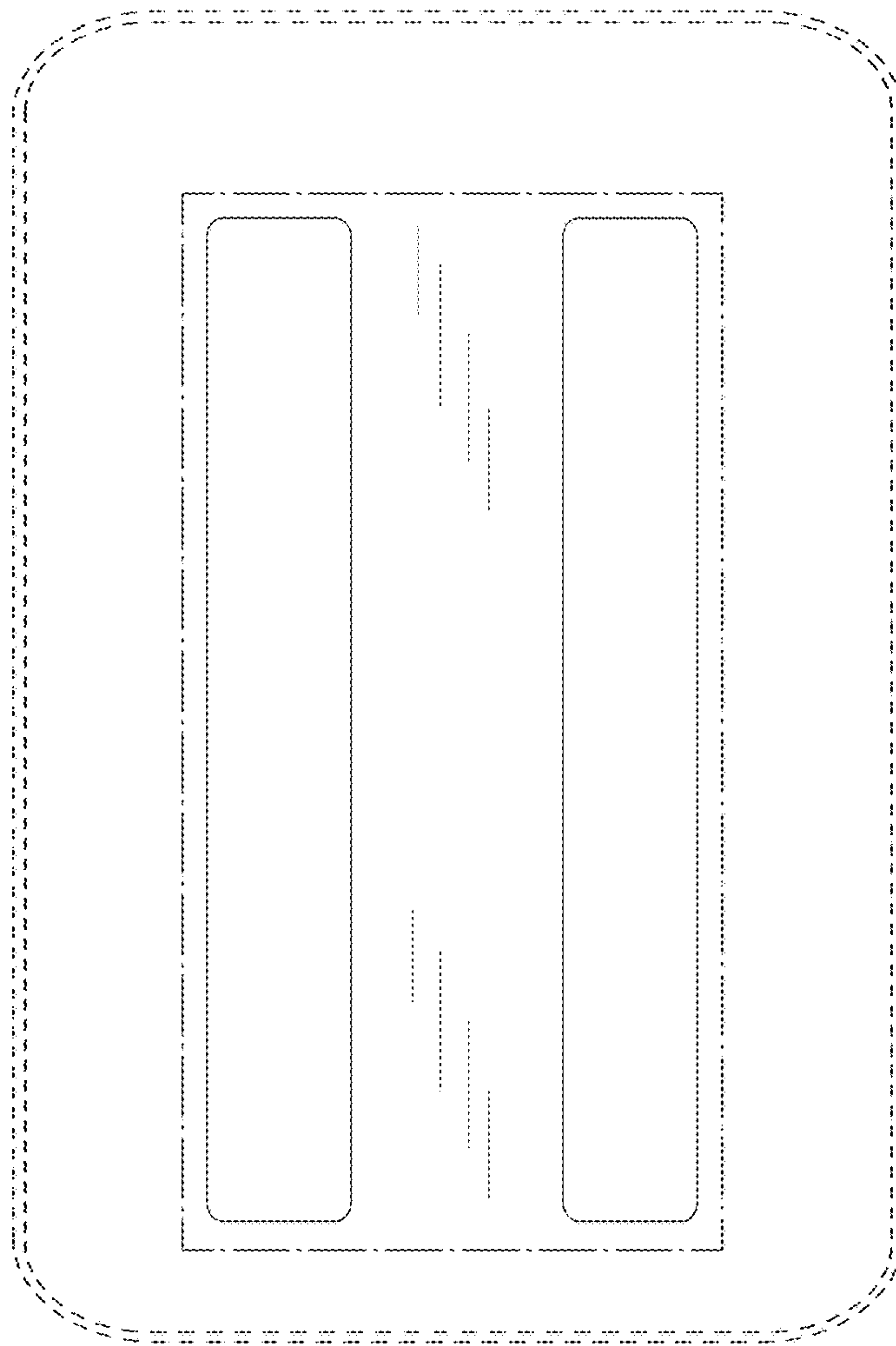

FIG. 56



FIG. 57

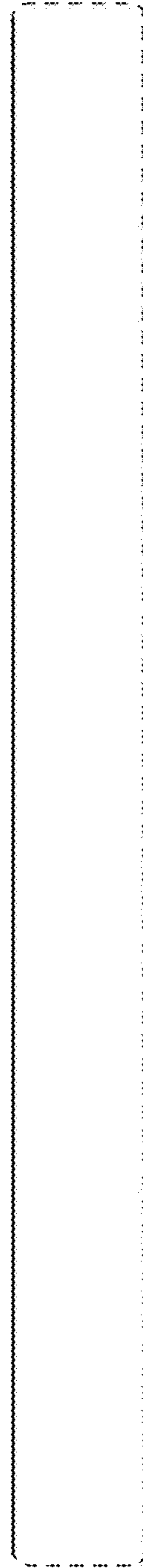

FIG. 58



FIG. 59

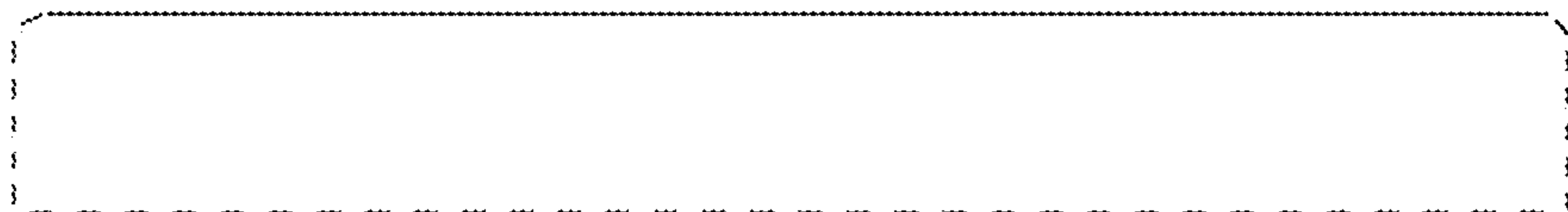

FIG. 60

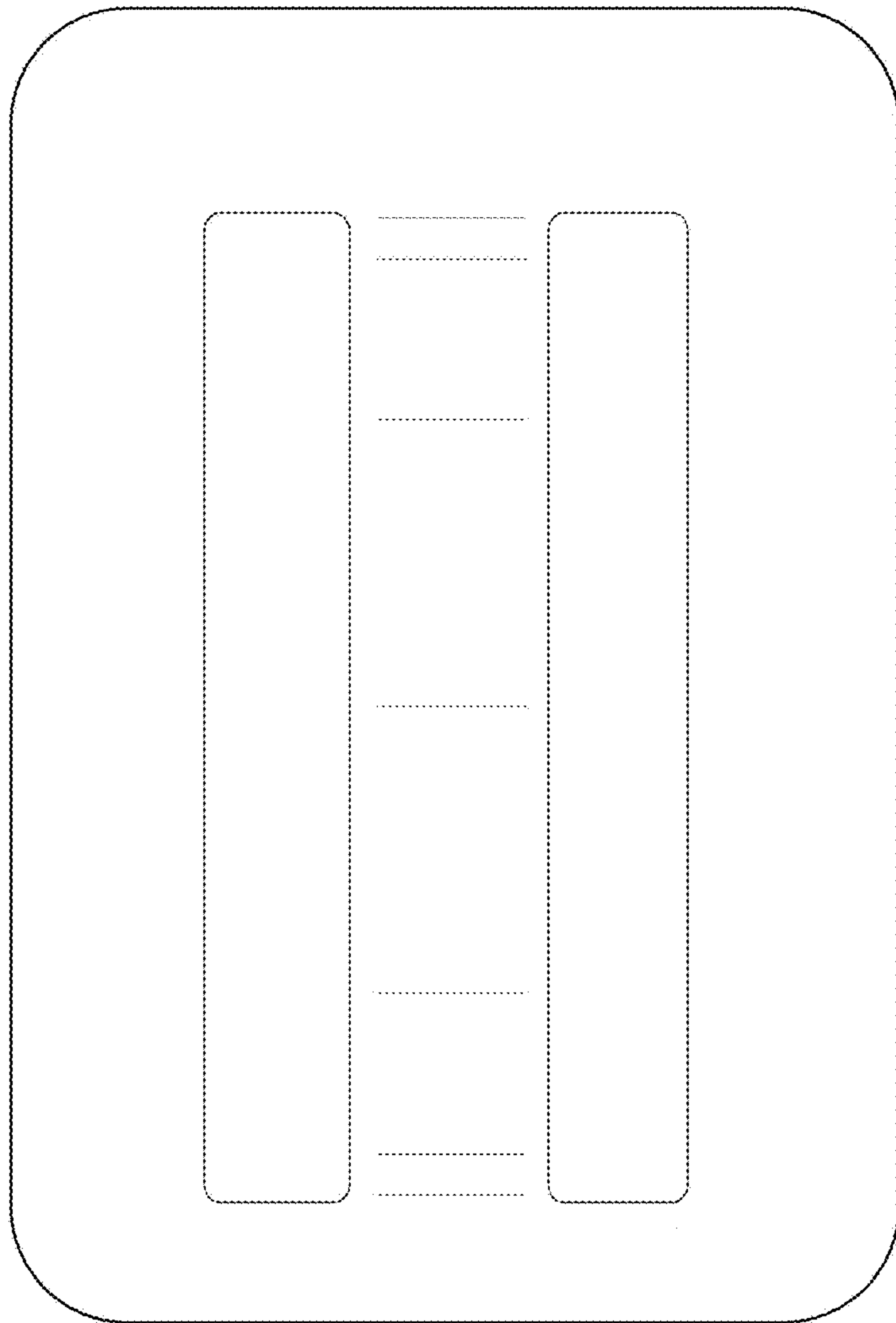

FIG. 61

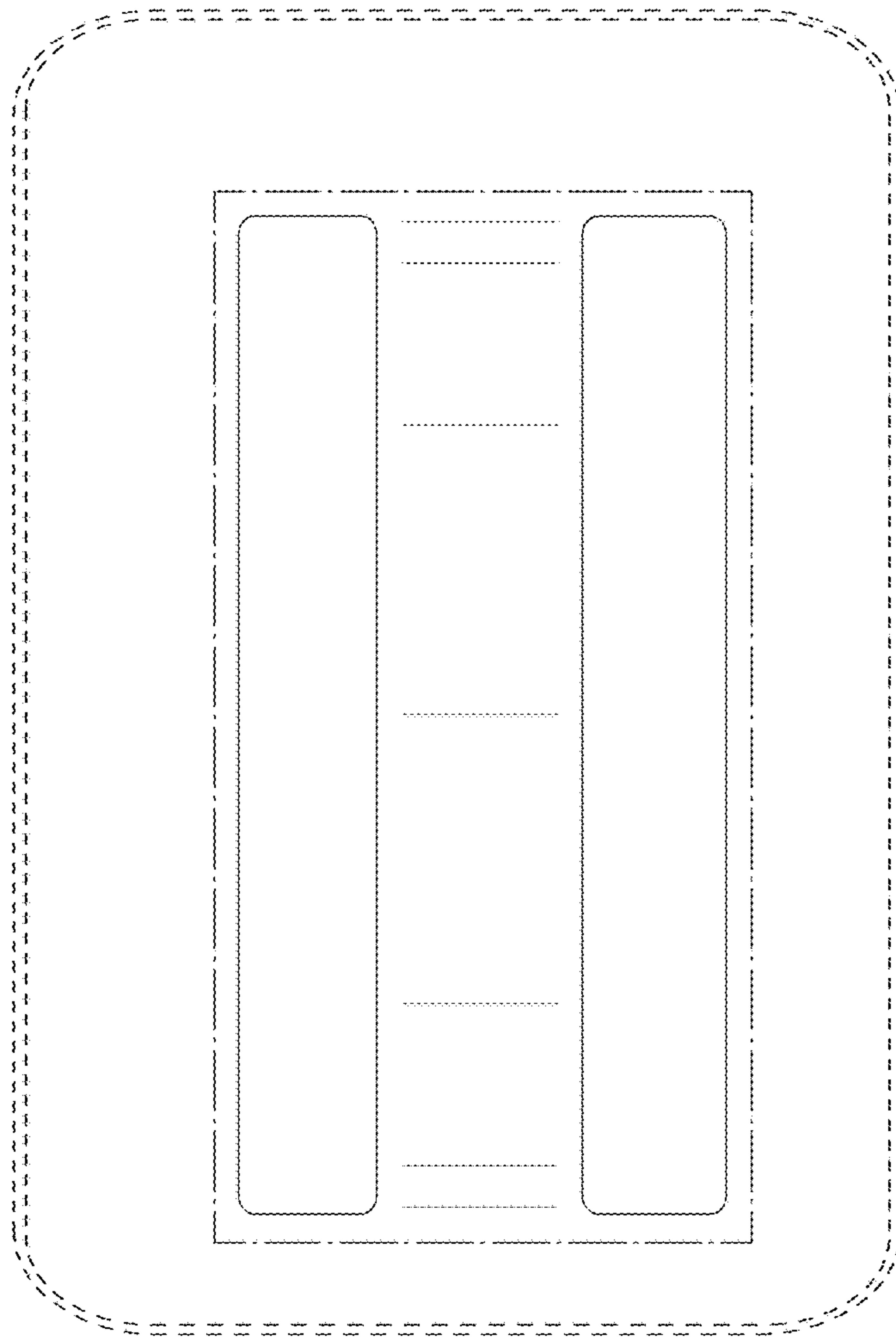

FIG. 62

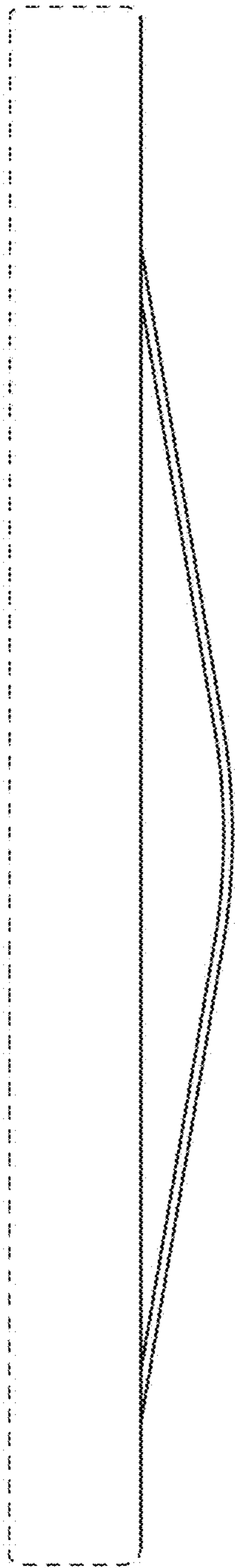

FIG. 63

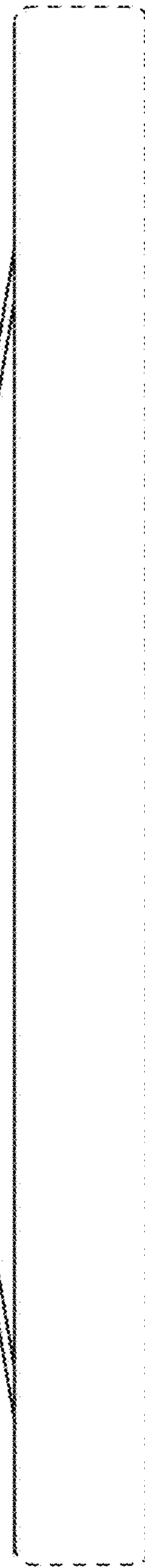

FIG. 64

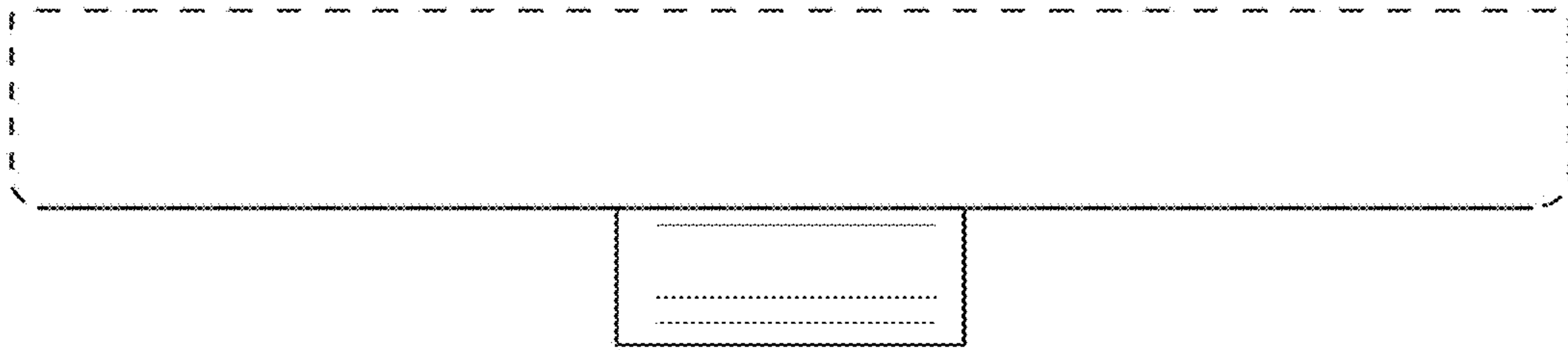

FIG. 65

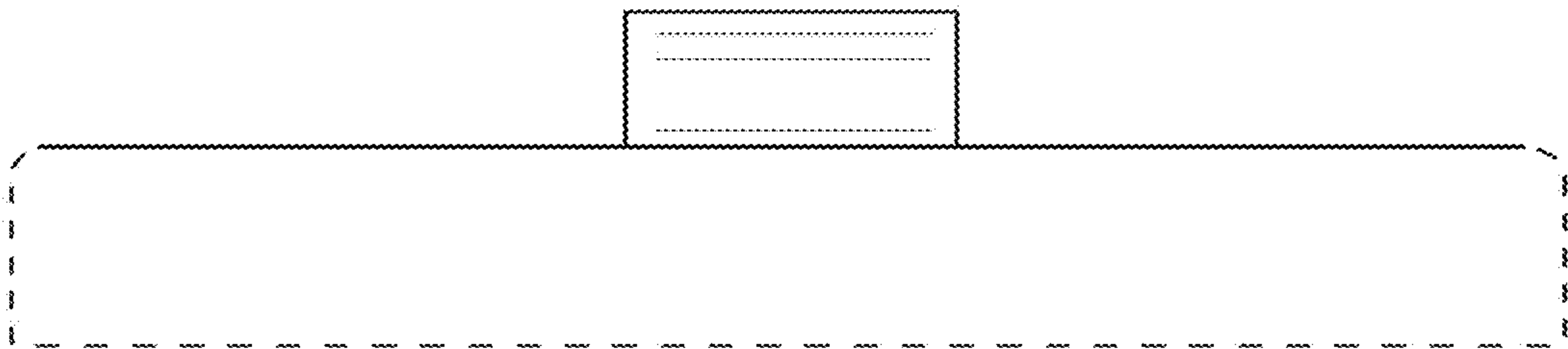

FIG. 66

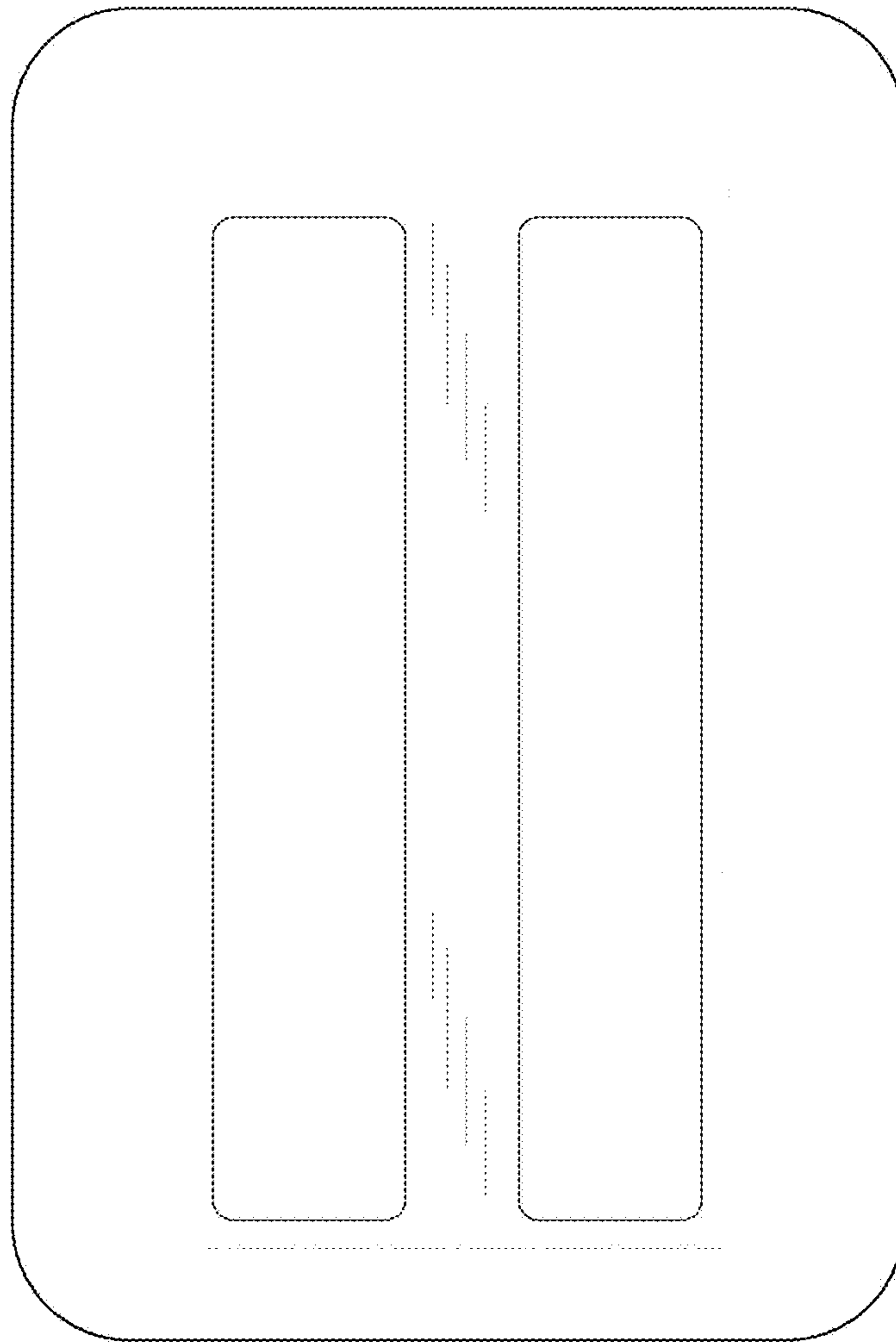

FIG. 67

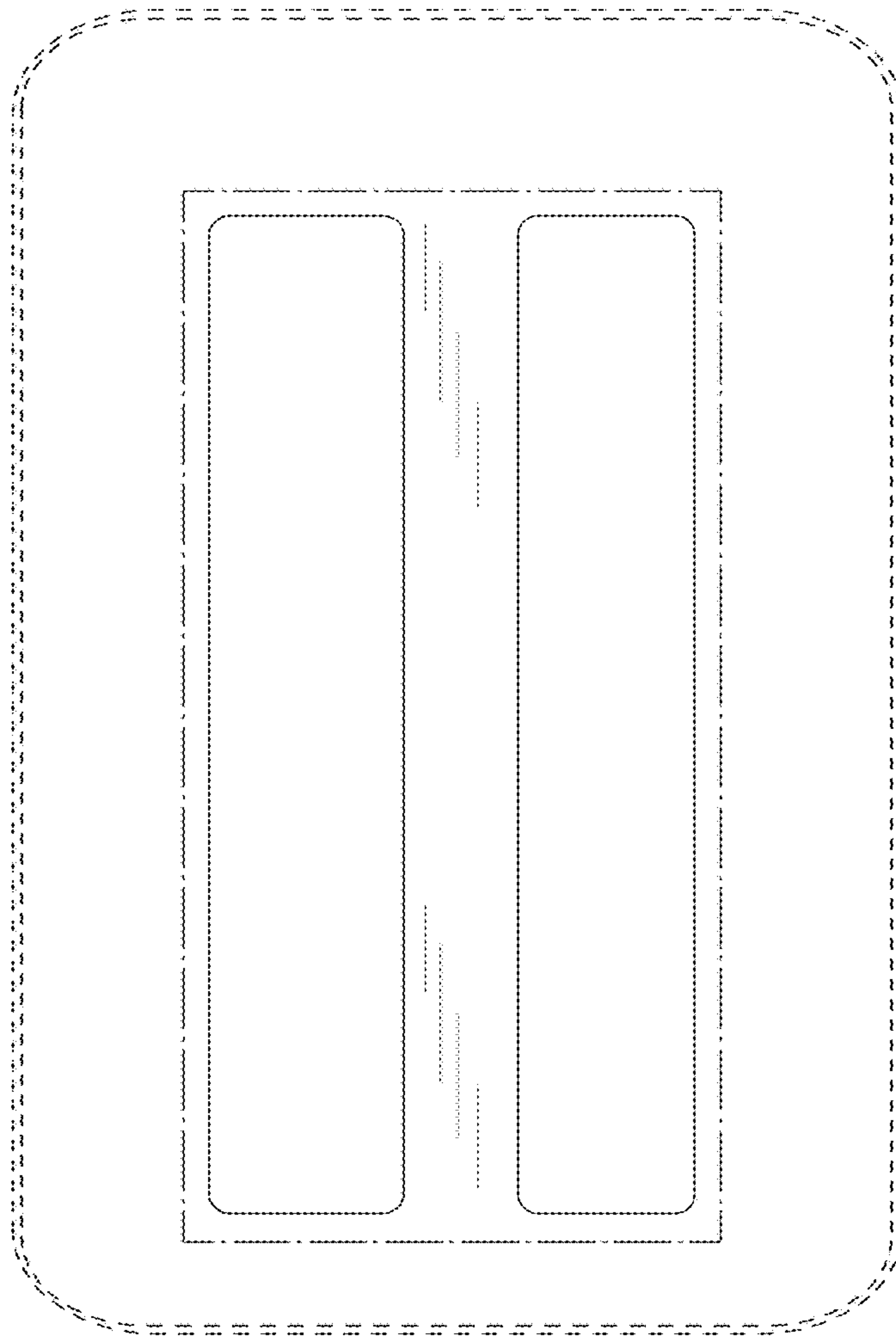

FIG. 68

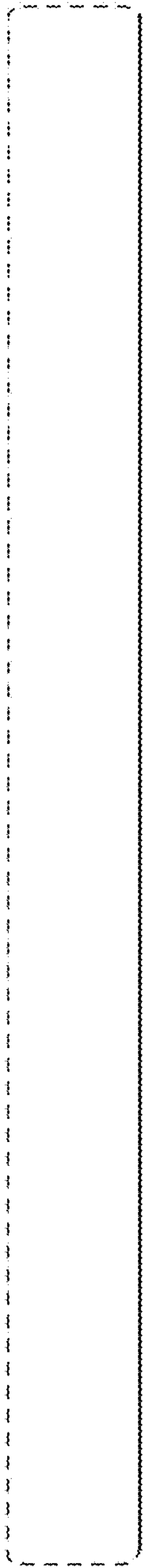

FIG. 69

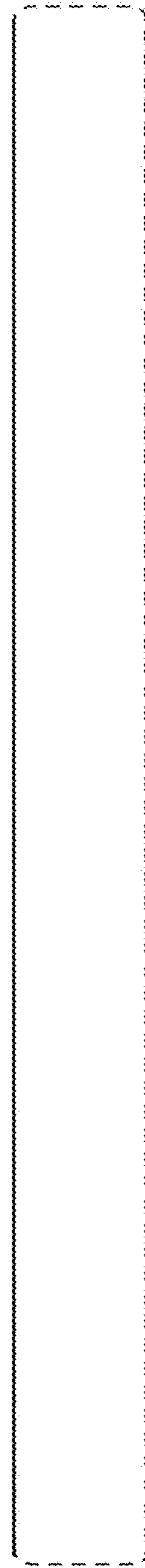

FIG. 70



FIG. 71



FIG. 72

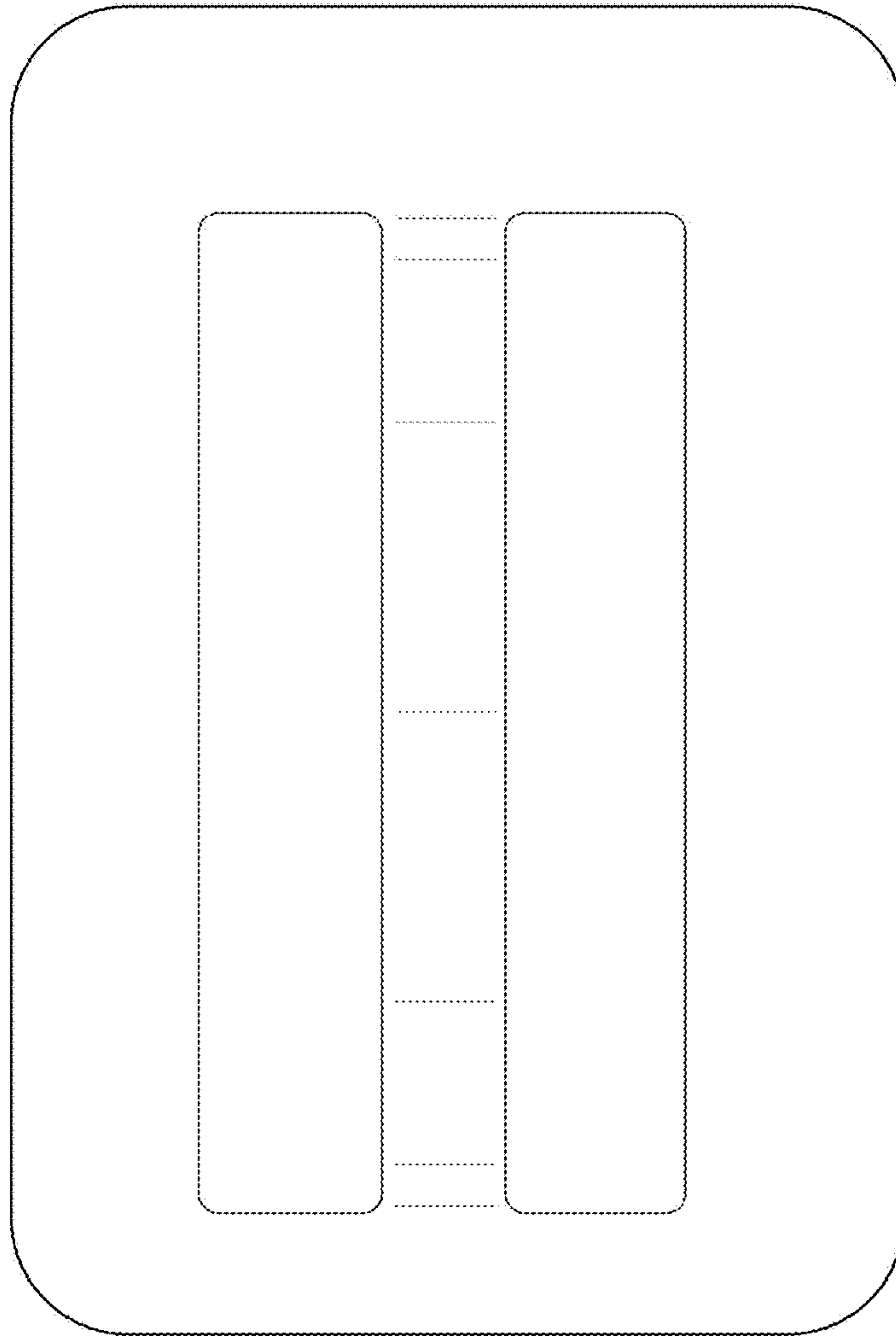

FIG. 73

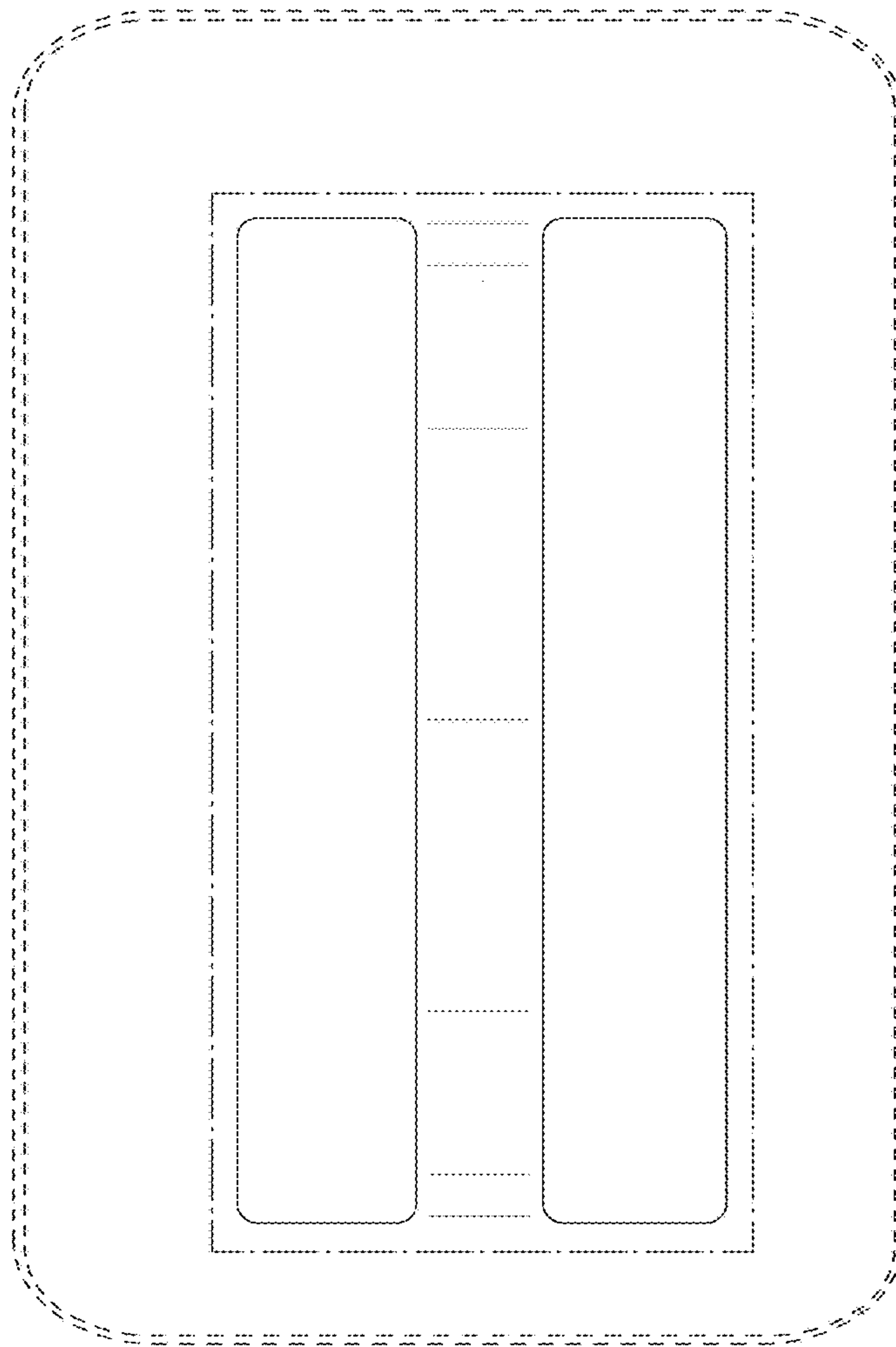

FIG. 74

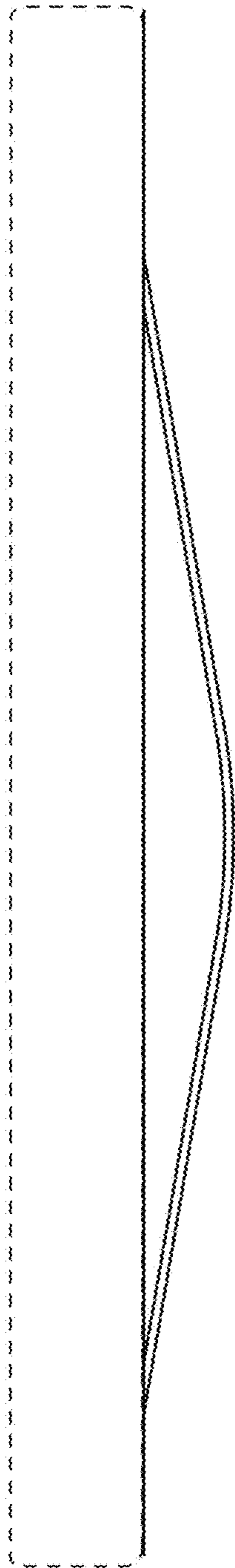

FIG. 75

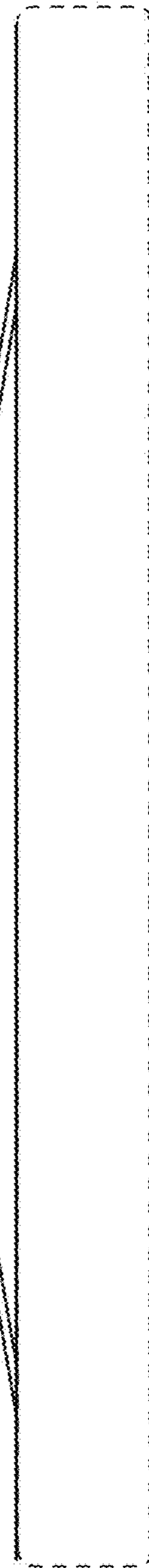

FIG. 76

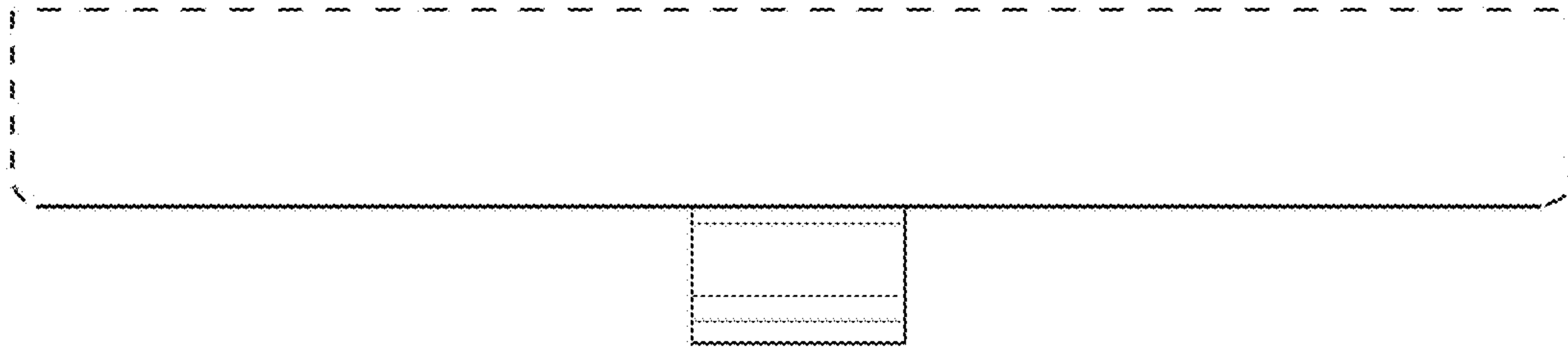

FIG. 77

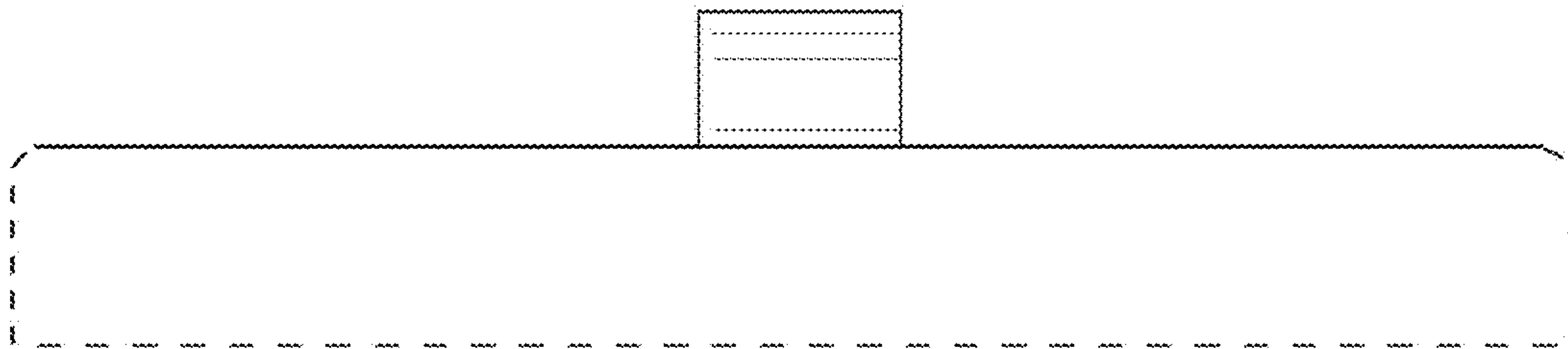

FIG. 78