

US00D842288S

(12) **United States Design Patent**
Hori et al.

(10) **Patent No.:** **US D842,288 S**
(45) **Date of Patent:** **** Mar. 5, 2019**

(54) **SMARTPHONE CASE**
(71) Applicant: **Kabushiki Kaisha Unwind**, Tokyo (JP)
(72) Inventors: **Ryoichi Hori**, Tokyo (JP); **Kyoko Uemura**, Tokyo (JP)
(73) Assignee: **Kabushiki Kaisha Unwind**, Tokyo (JP)
(**) Term: **15 Years**

(21) Appl. No.: **29/573,681**
(22) Filed: **Aug. 9, 2016**
(51) **LOC (11) Cl.** **14-03**
(52) **U.S. Cl.**
USPC **D14/250**
(58) **Field of Classification Search**
USPC D14/143, 189, 203.2-203.7, 217, 238.1,
D14/240, 248, 250-253, 440, 447, 496;
(Continued)

(56) **References Cited**
U.S. PATENT DOCUMENTS
D601,558 S * 10/2009 Andre D14/138 G
D606,751 S * 12/2009 Andre D3/269
(Continued)

FOREIGN PATENT DOCUMENTS
JP 1522939 S 4/2015

OTHER PUBLICATIONS
GADGEO iPhone 6, posted at amazon.com, earliest date reviewed on Mar. 18, 2015, [online], acquired on Jan. 2, 2018. Available from Internet, <URL: <https://www.amazon.co.uk/GADGEO-iPhone-Transparent-Protector-Protection-Clear/dp/B00U9B4QAK>> (Year: 2015).*
(Continued)

Primary Examiner — Karen E Kearney
Assistant Examiner — Aula Soroush

(74) *Attorney, Agent, or Firm* — Muncy, Geissler, Olds & Lowe, P.C.

(57) **CLAIM**
The ornamental design for a smartphone case, as shown and described.

DESCRIPTION
FIG. 1 is a front elevational view of a smartphone case showing our new design;
FIG. 2 is a rear elevational view thereof;
FIG. 3 is a top plan view thereof;
FIG. 4 is a bottom plan view thereof;
FIG. 5 is a right side view thereof;
FIG. 6 is a left side view thereof;
FIG. 7 is a front, right, bottom perspective view thereof;
FIG. 8 is a rear, bottom, left perspective view thereof;
FIG. 9 is a cross-sectional view thereof, taken along line 9-9 of FIG. 1;
FIG. 10 is a front elevational view of the upper cover portion of the smartphone case;
FIG. 11 is a rear elevational view thereof;
FIG. 12 is a top plan view thereof;
FIG. 13 is a bottom plan view thereof;
FIG. 14 is a right side view thereof;
FIG. 15 is a left side view thereof;
FIG. 16 is a front, right, bottom perspective view thereof;
FIG. 17 is a front elevational view of the lower cover portion of the smartphone case;
FIG. 18 is a rear elevational view thereof;
FIG. 19 is a top plan view thereof;
FIG. 20 is a bottom plan view thereof;
FIG. 21 is a front, right, bottom perspective view thereof;
FIG. 22 is a front elevational view of a second embodiment of the smartphone case;
FIG. 23 is a rear elevational view thereof;
FIG. 24 is a top plan view thereof;
FIG. 25 is a bottom plan view thereof;
FIG. 26 is a right side view thereof;
FIG. 27 is a left side view thereof;
FIG. 28 is a front, right, bottom perspective view thereof;
FIG. 29 is a rear, bottom, left perspective view thereof;
(Continued)

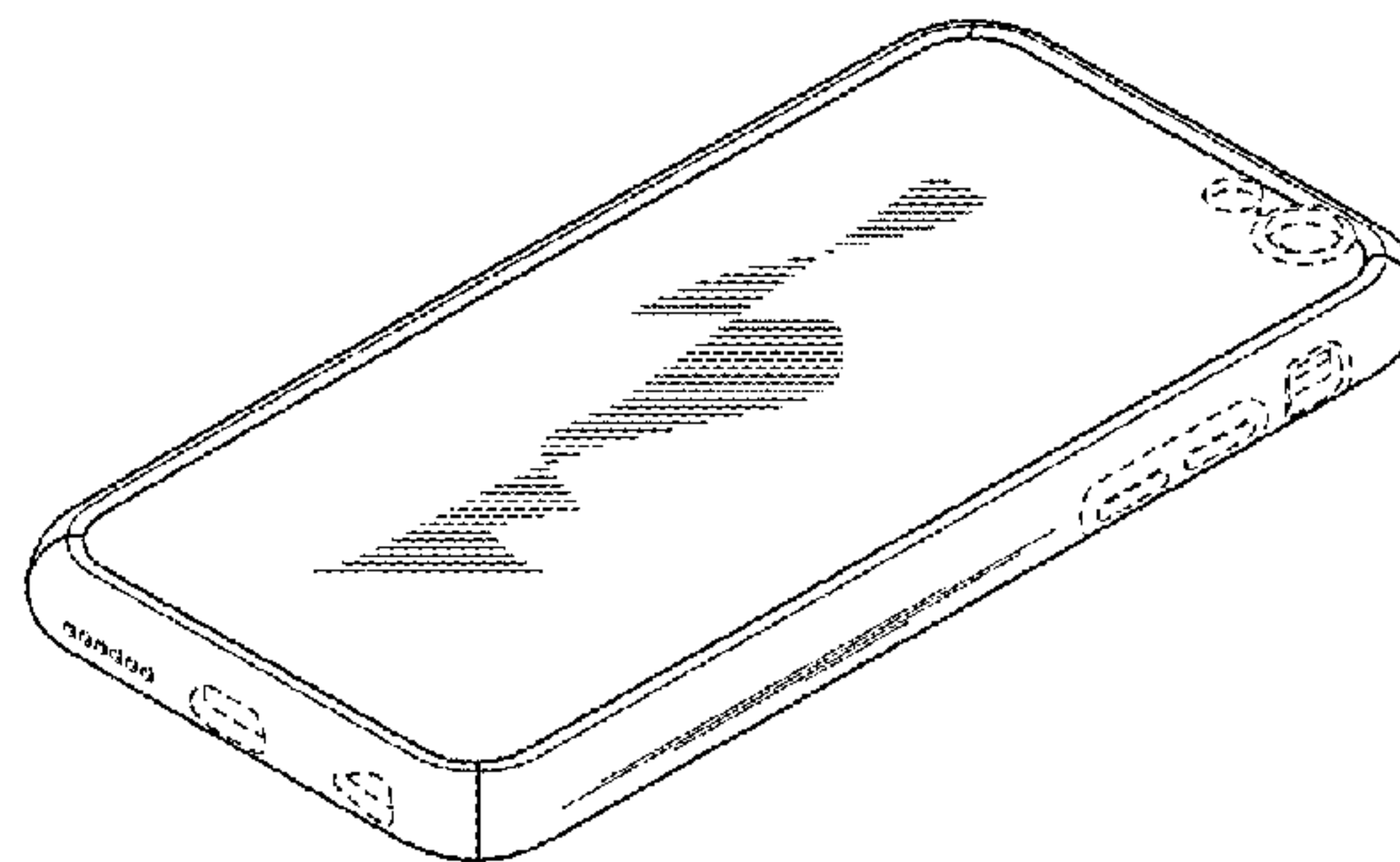
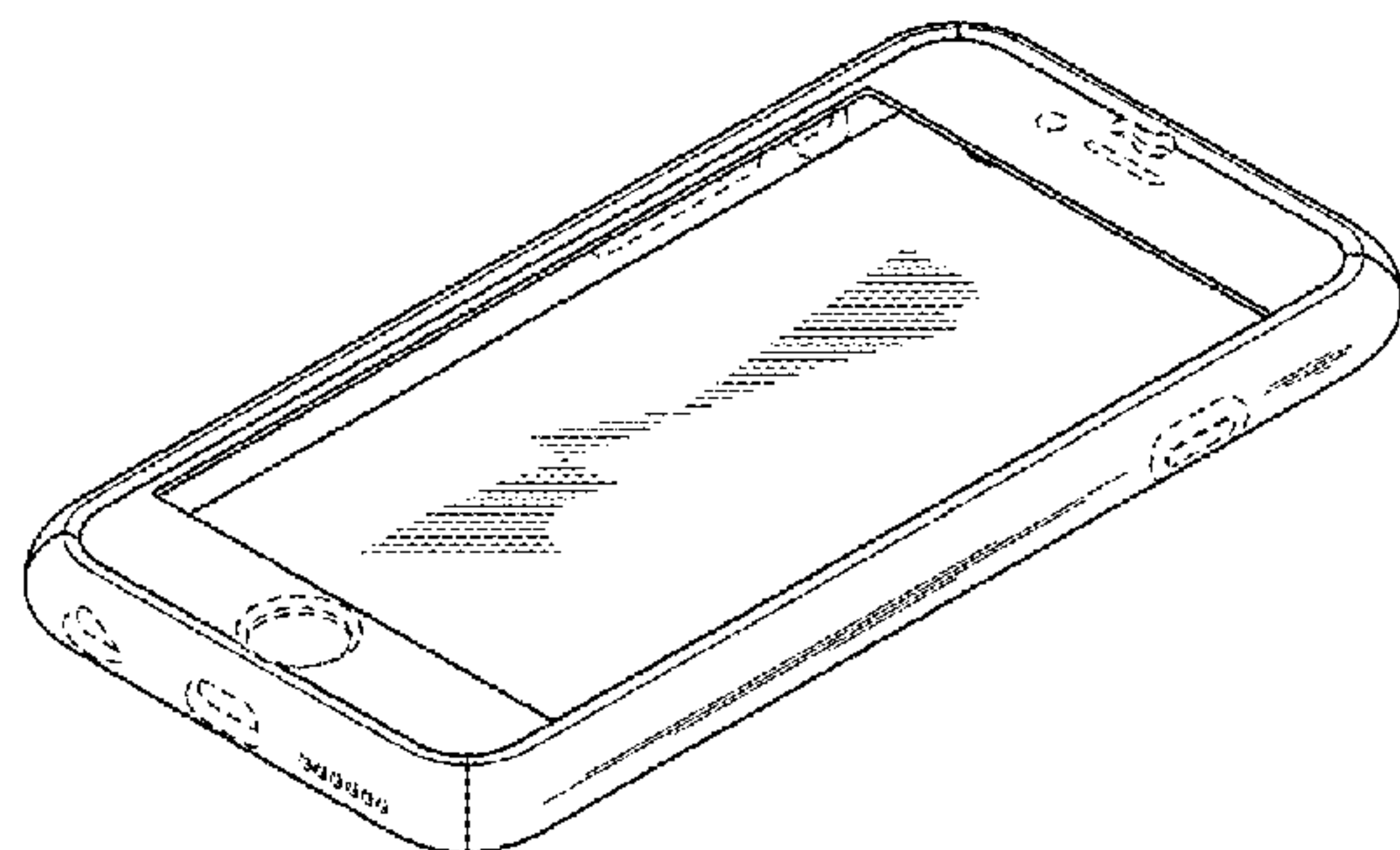

FIG. 30 is a cross-sectional view thereof, taken along line 30-30 of FIG. 22;
 FIG. 31 is a front elevational view of the upper cover portion of the second embodiment of the smartphone case;
 FIG. 32 is a rear elevational view thereof;
 FIG. 33 is a top plan view thereof;
 FIG. 34 is a bottom plan view thereof;
 FIG. 35 is a right side view thereof;
 FIG. 36 is a left side view thereof;
 FIG. 37 is a front, right, bottom perspective view thereof;
 FIG. 38 is a front elevational view of the upper cover portion of the second embodiment of the smartphone case;
 FIG. 39 is a rear elevational view thereof;
 FIG. 40 is a top plan view thereof;
 FIG. 41 is a bottom plan view thereof;
 FIG. 42 is a front, right, bottom perspective view thereof;
 FIG. 43 is a front elevational view of a third embodiment of the smartphone case;
 FIG. 44 is a rear elevational view thereof;
 FIG. 45 is a top plan view thereof;
 FIG. 46 is a bottom plan view thereof;
 FIG. 47 is a right side view thereof;
 FIG. 48 is a left side view thereof;
 FIG. 49 is a front, right, bottom perspective view thereof;
 FIG. 50 is a rear, bottom, left perspective view thereof;
 FIG. 51 is a cross-sectional view thereof, taken along line 51-51 of FIG. 43;
 FIG. 52 is a front elevational view of the upper cover portion of the third embodiment of the smartphone case;
 FIG. 53 is a rear elevational view thereof;
 FIG. 54 is a top plan view thereof;
 FIG. 55 is a bottom plan view thereof;
 FIG. 56 is a right side view thereof;
 FIG. 57 is a left side view thereof;
 FIG. 58 is a front, right, bottom perspective view thereof;
 FIG. 59 is a front elevational view of the lower cover portion of the third embodiment of the smartphone case;
 FIG. 60 is a rear elevational view thereof;
 FIG. 61 is a top plan view thereof;
 FIG. 62 is a bottom plan view thereof; and,
 FIG. 63 is a front, right, bottom perspective view thereof.

The broken lines are for the purpose of illustrating portions of the smartphone case which form no part of the claimed design.

1 Claim, 33 Drawing Sheets

(58) **Field of Classification Search**

USPC D3/201, 218, 247-251, 269, 273, 301, D3/303; D13/103, 107-108, 119
 CPC A45C 1/06; A45C 11/00; A45C 13/02; A45C 2011/002; A45F 2005/026; A45F 2200/0525; A45F 2200/0516; H04B 1/3888; H04M 1/0283; H04M 1/0202
 See application file for complete search history.

(56) **References Cited**

U.S. PATENT DOCUMENTS

D613,282	S	*	4/2010	Richardson	D14/250
D619,130	S	*	7/2010	Fellig	D14/250
D622,716	S	*	8/2010	Andre	D14/250
D626,119	S	*	10/2010	Fellig	D14/250
D692,878	S	*	11/2013	Akana	D14/341
D693,341	S	*	11/2013	Akana	D14/341
D693,801	S	*	11/2013	Rayner	D14/250
D694,227	S	*	11/2013	Rayner	D14/250
D695,297	S	*	12/2013	Sun	D14/440
D696,251	S	*	12/2013	Andre	D14/341
D703,652	S	*	4/2014	Melanson	D14/250
D753,099	S	*	4/2016	Kim	D14/250
D755,187	S	*	5/2016	Shannon, III	D14/440
D772,854	S	*	11/2016	Igarashi	D14/250
D772,855	S	*	11/2016	Ju	D14/250
D781,836	S	*	3/2017	Kim	D14/250

OTHER PUBLICATIONS

JETech: iPhone 6s Plus Case, posted at amazon.com, earliest date reviewed on Sep. 1, 2015, [online], acquired on Jan. 2, 2018. Available from Internet, <URL: <https://www.amazon.com/JETech%C2%AE-Fortress-2-Piece-Protection-Protector/dp/B0142QXKXG>> (Year: 2015).*

* cited by examiner

FIG. 1

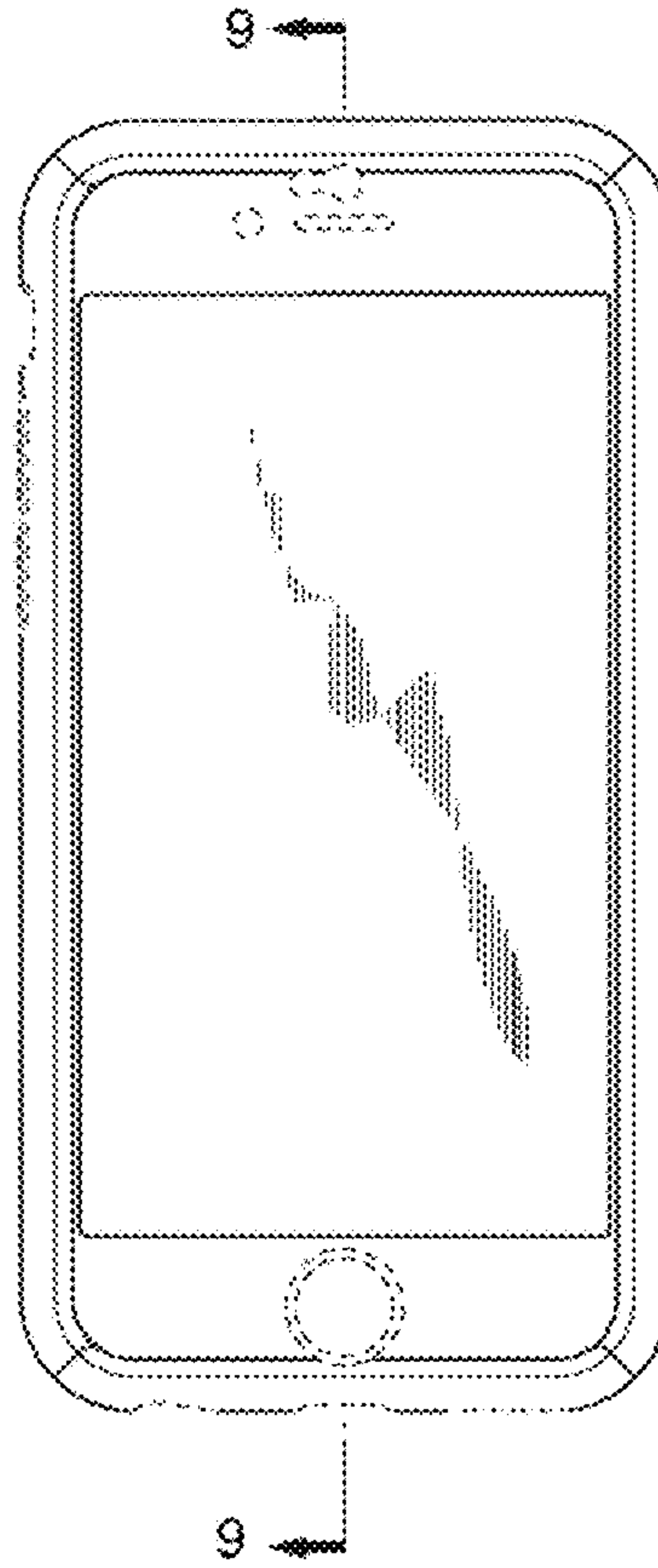

FIG. 2

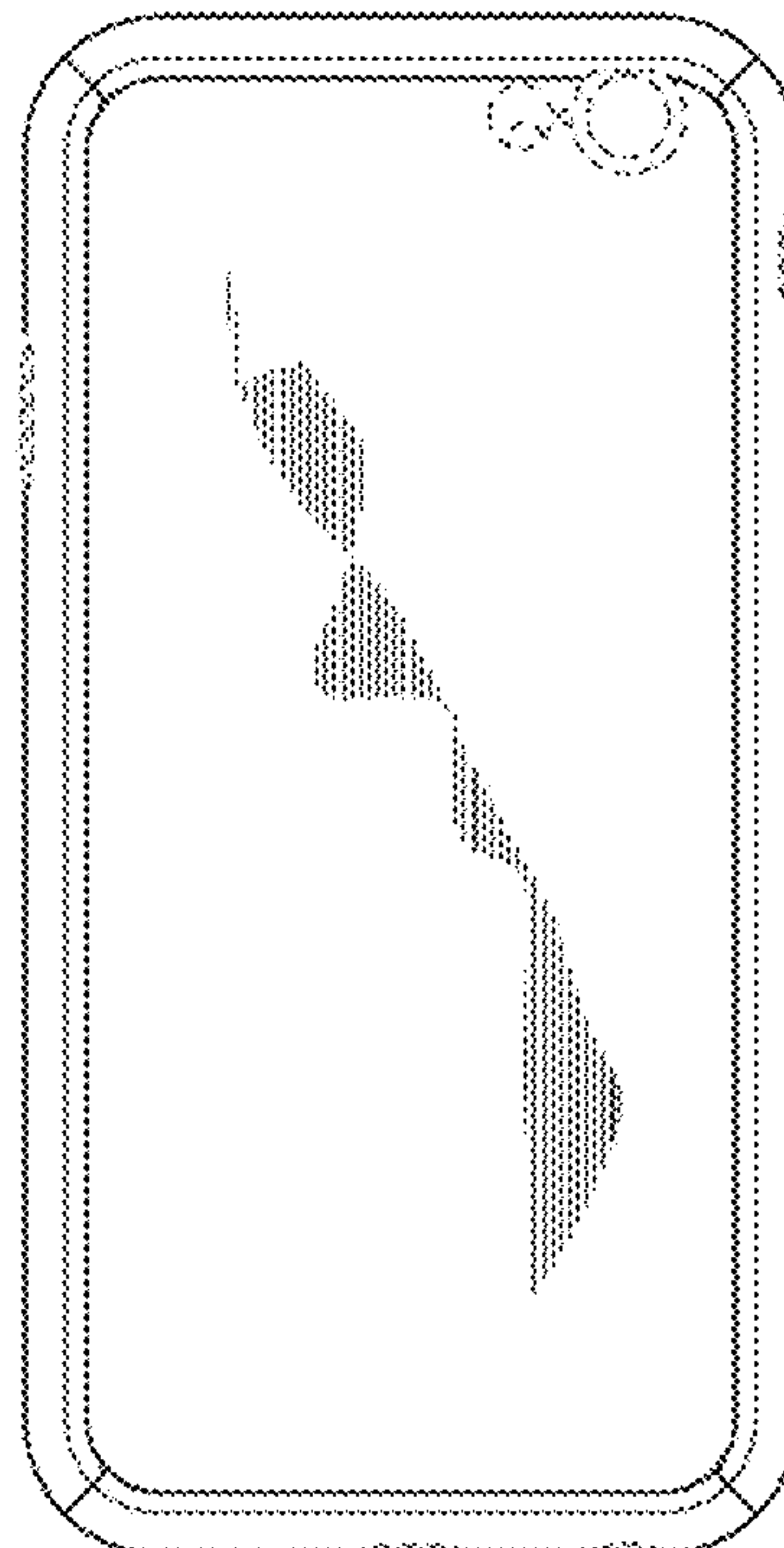

FIG. 3



FIG. 4



FIG. 5

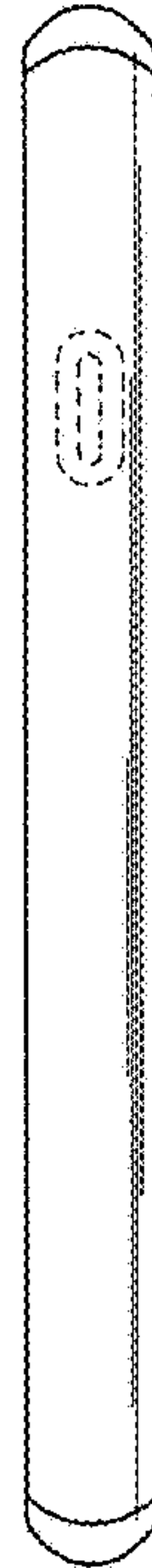

FIG. 6

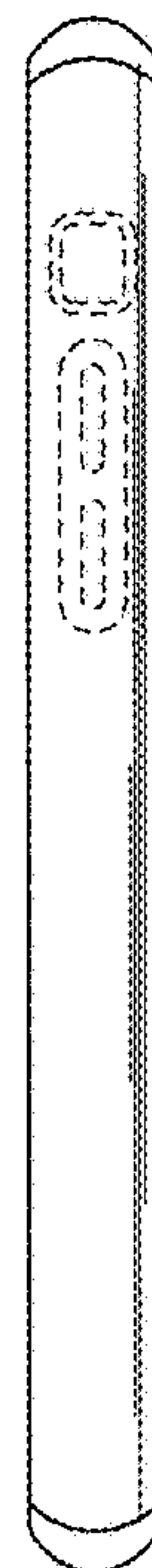

FIG. 7

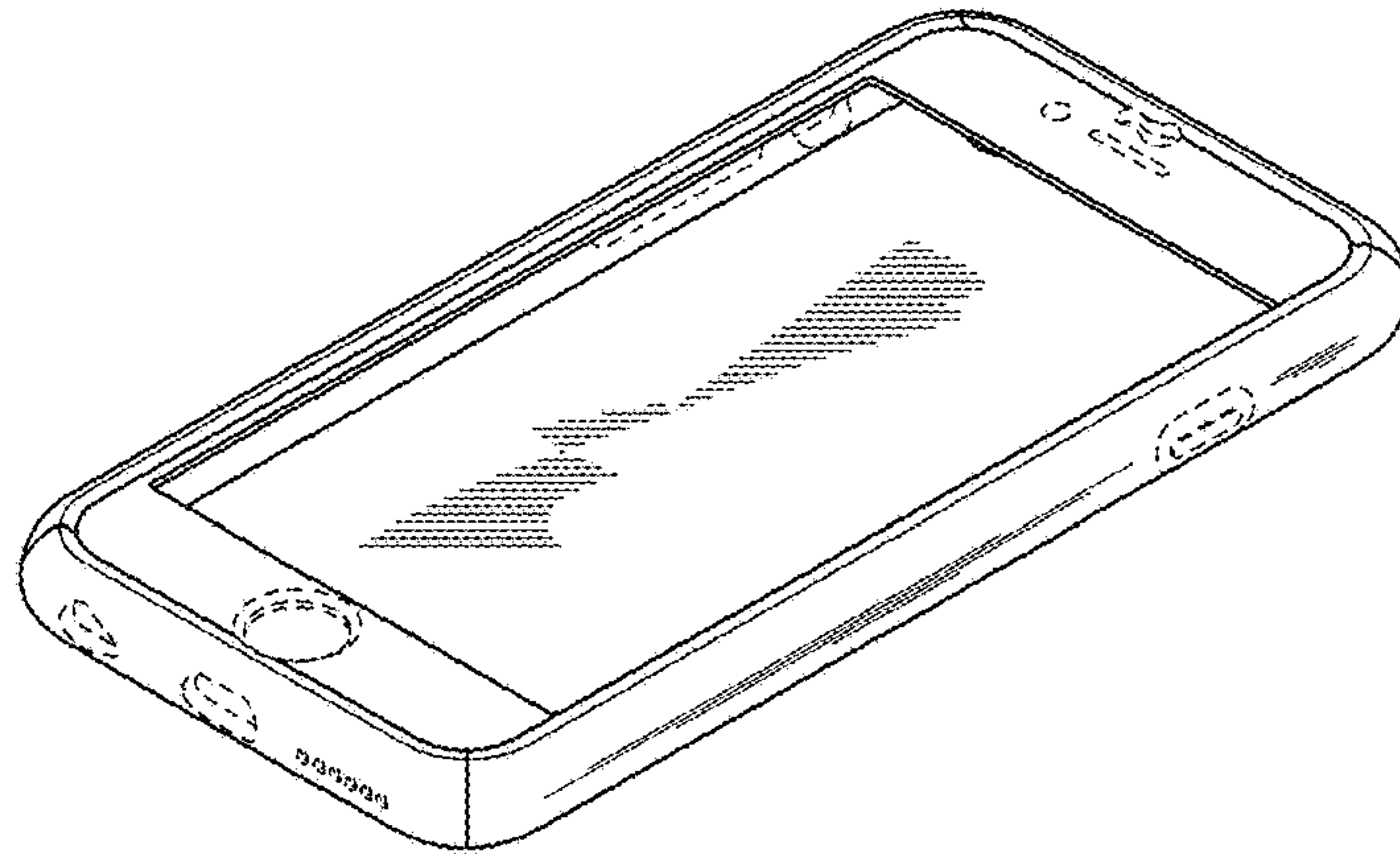

FIG. 8

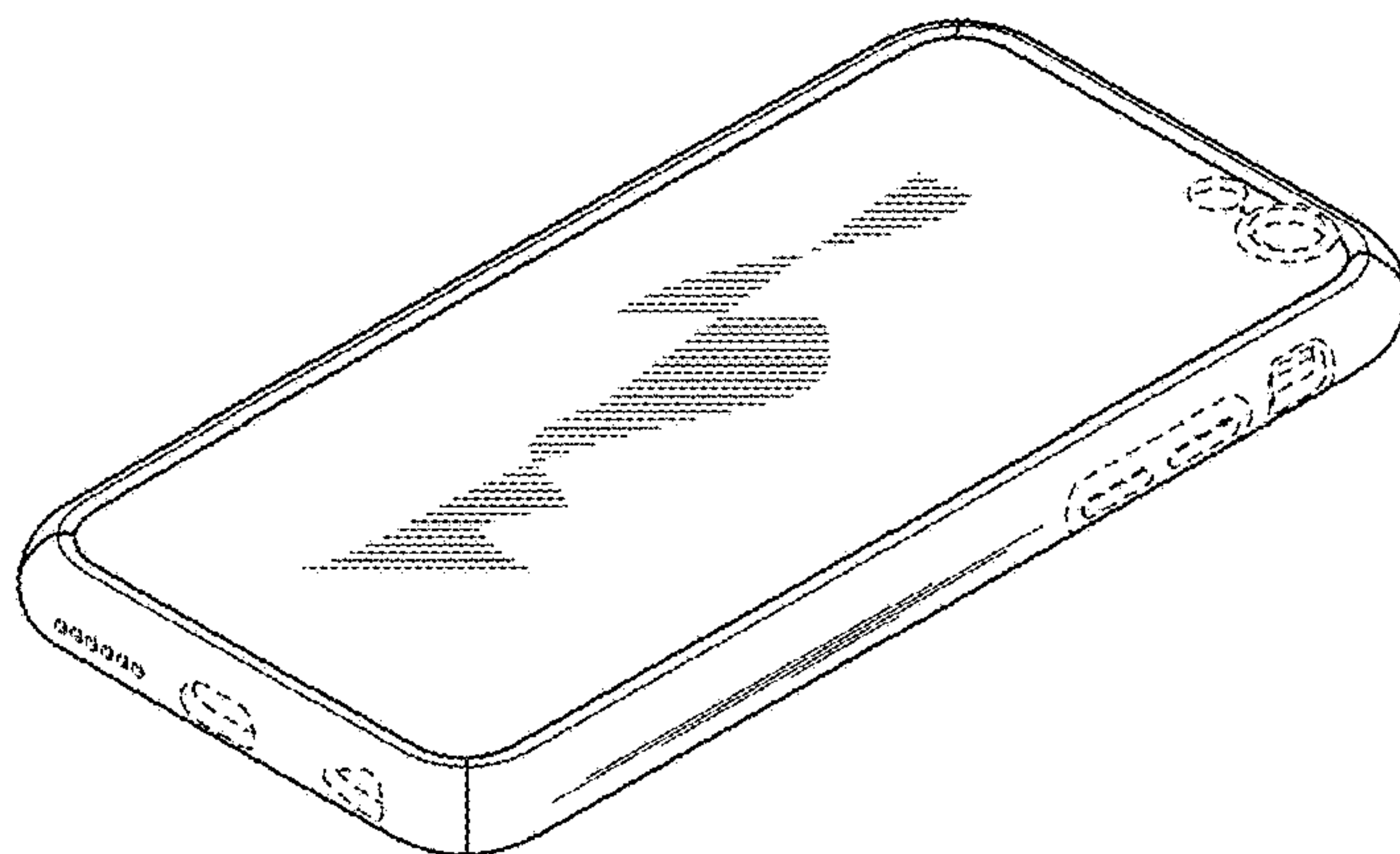

FIG. 9

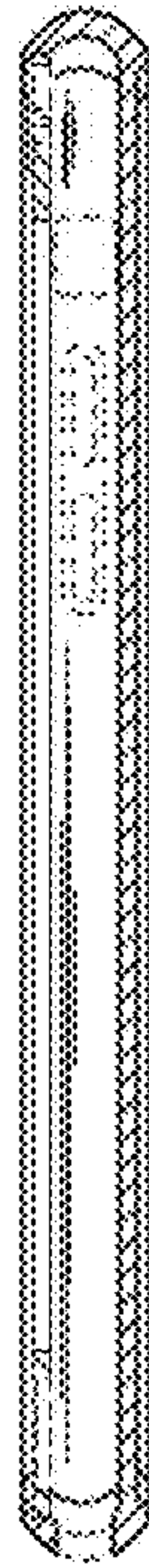

FIG. 10

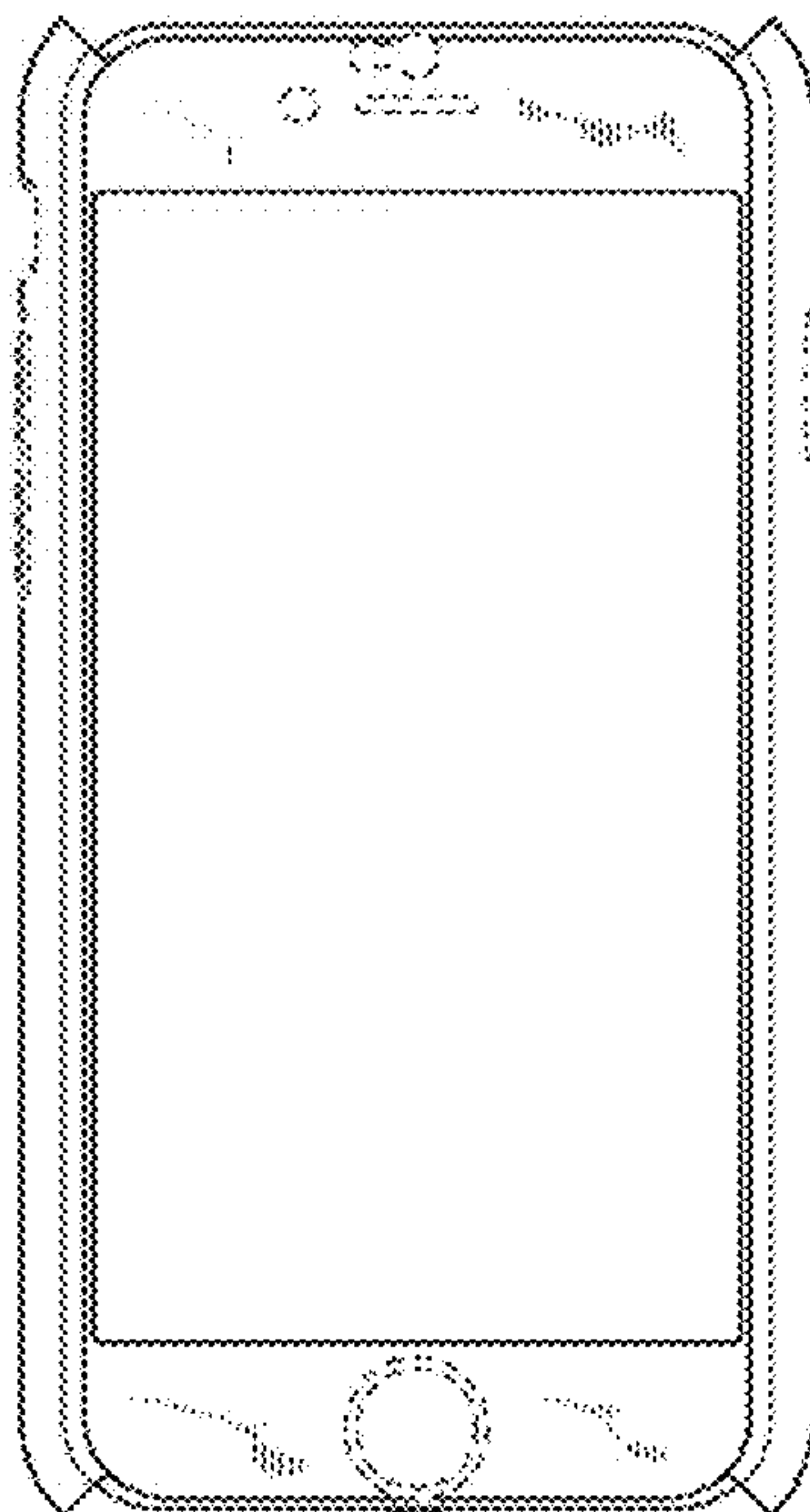

FIG. 11

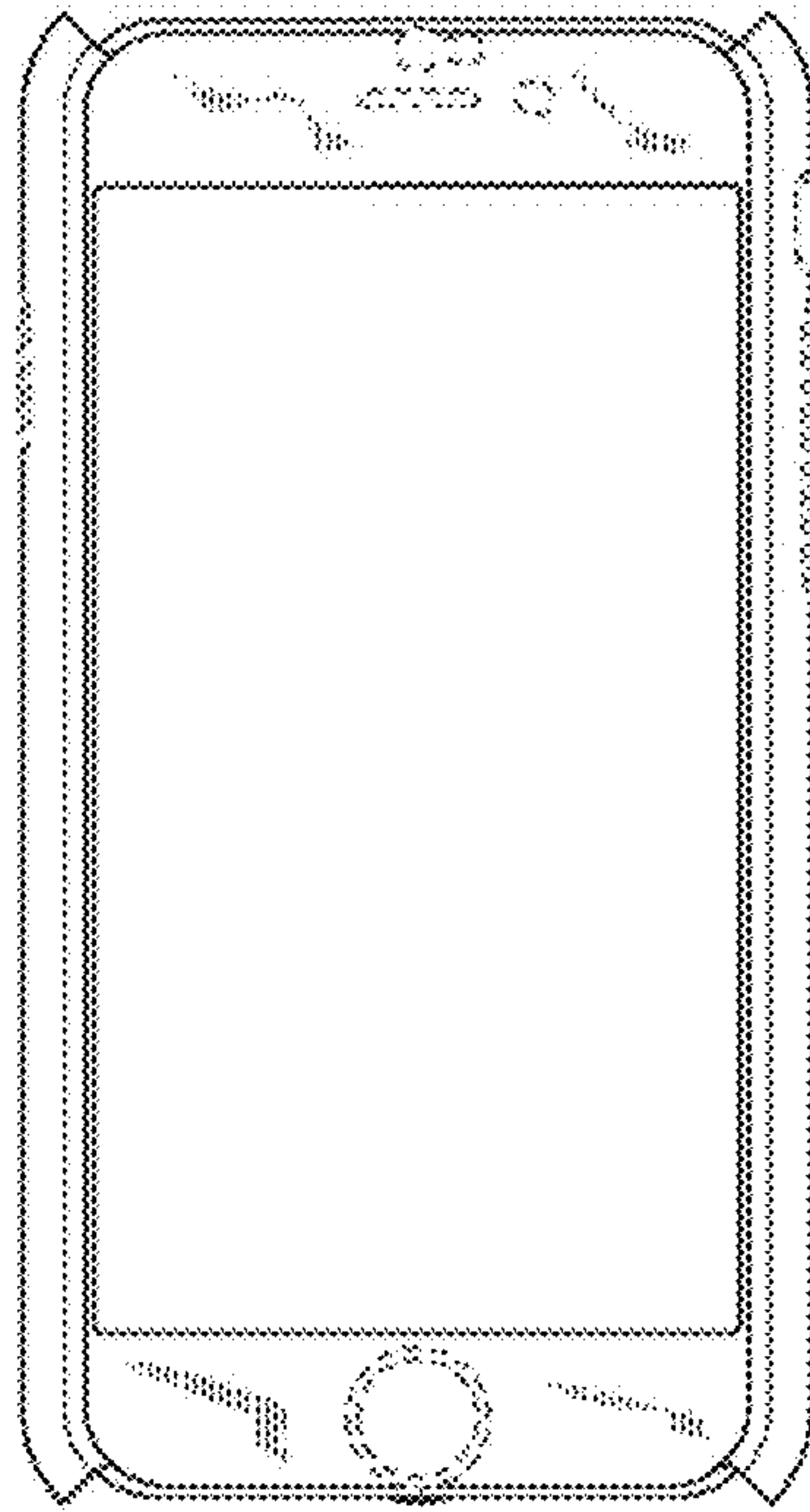

FIG. 12



FIG. 13

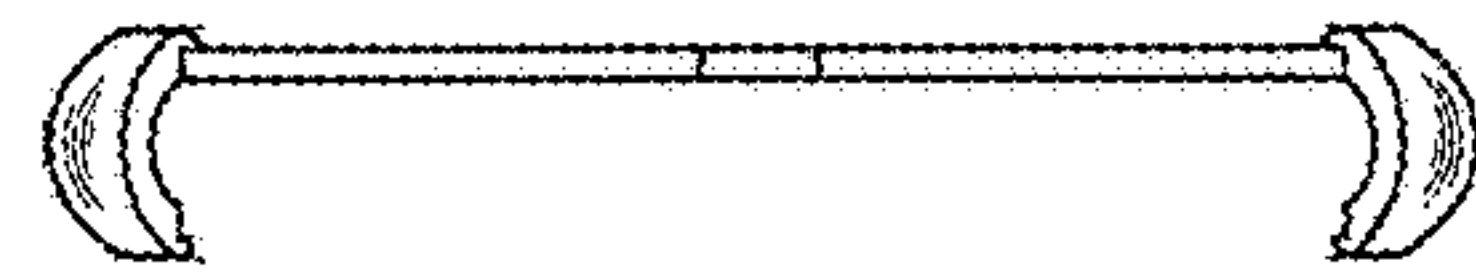

FIG. 14



FIG. 15



FIG. 16

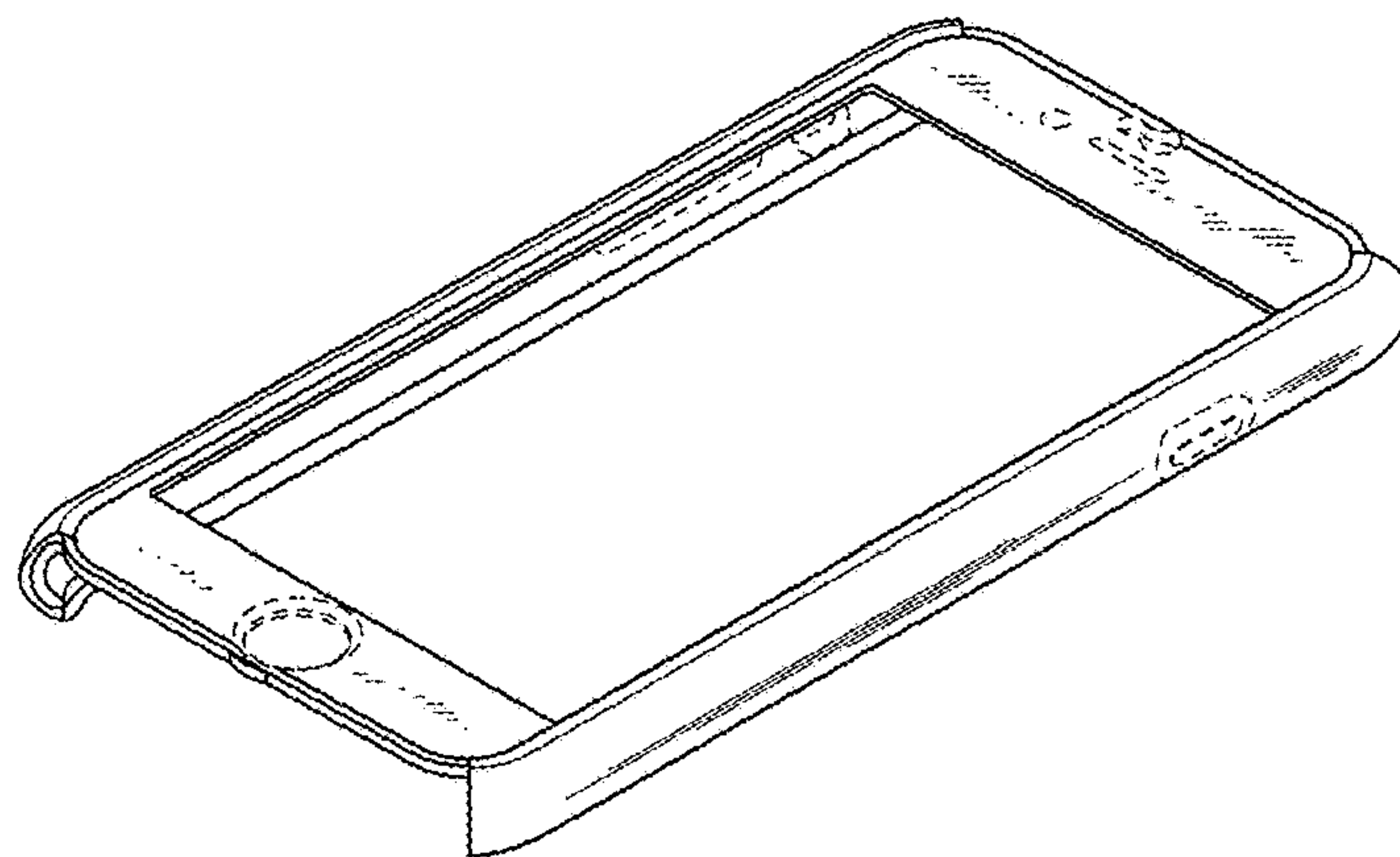

FIG. 17

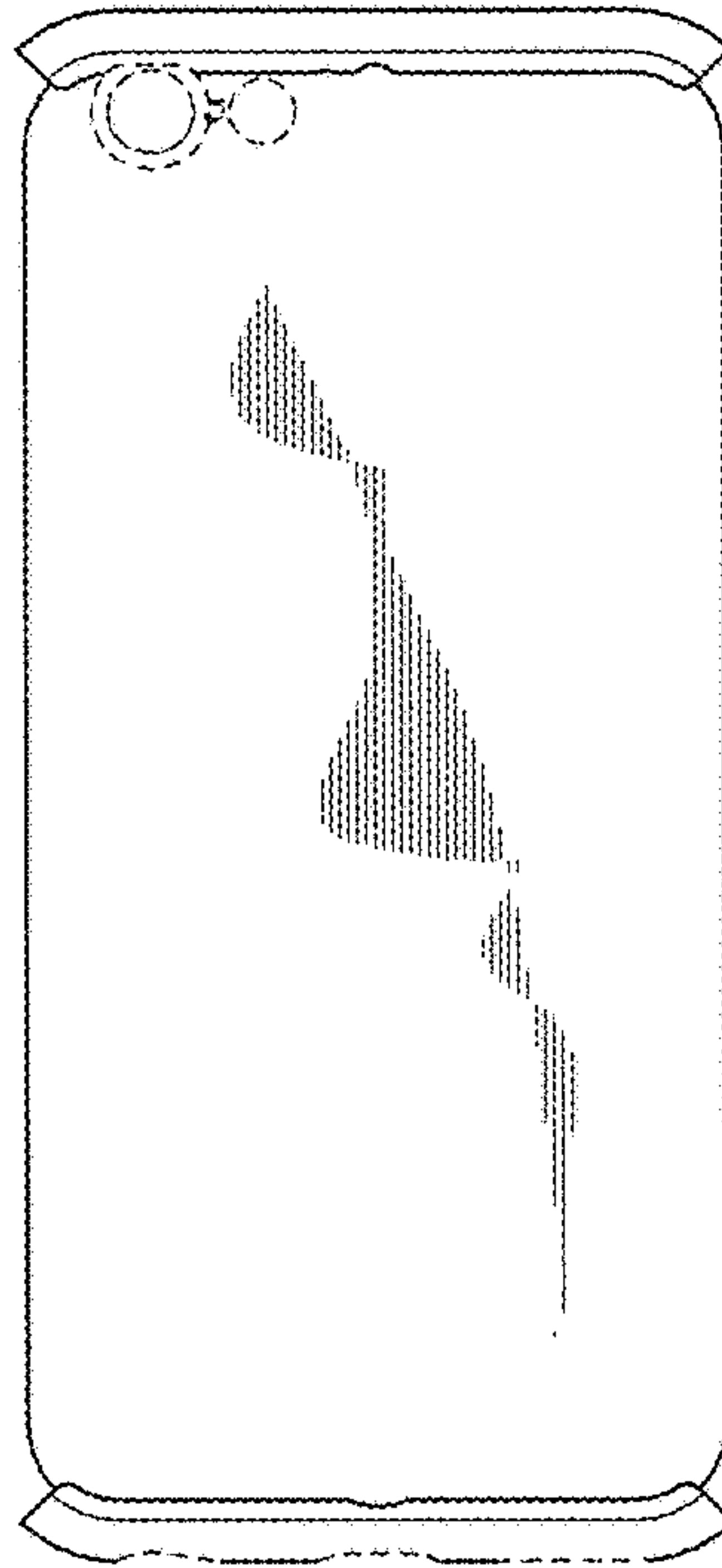

FIG. 18

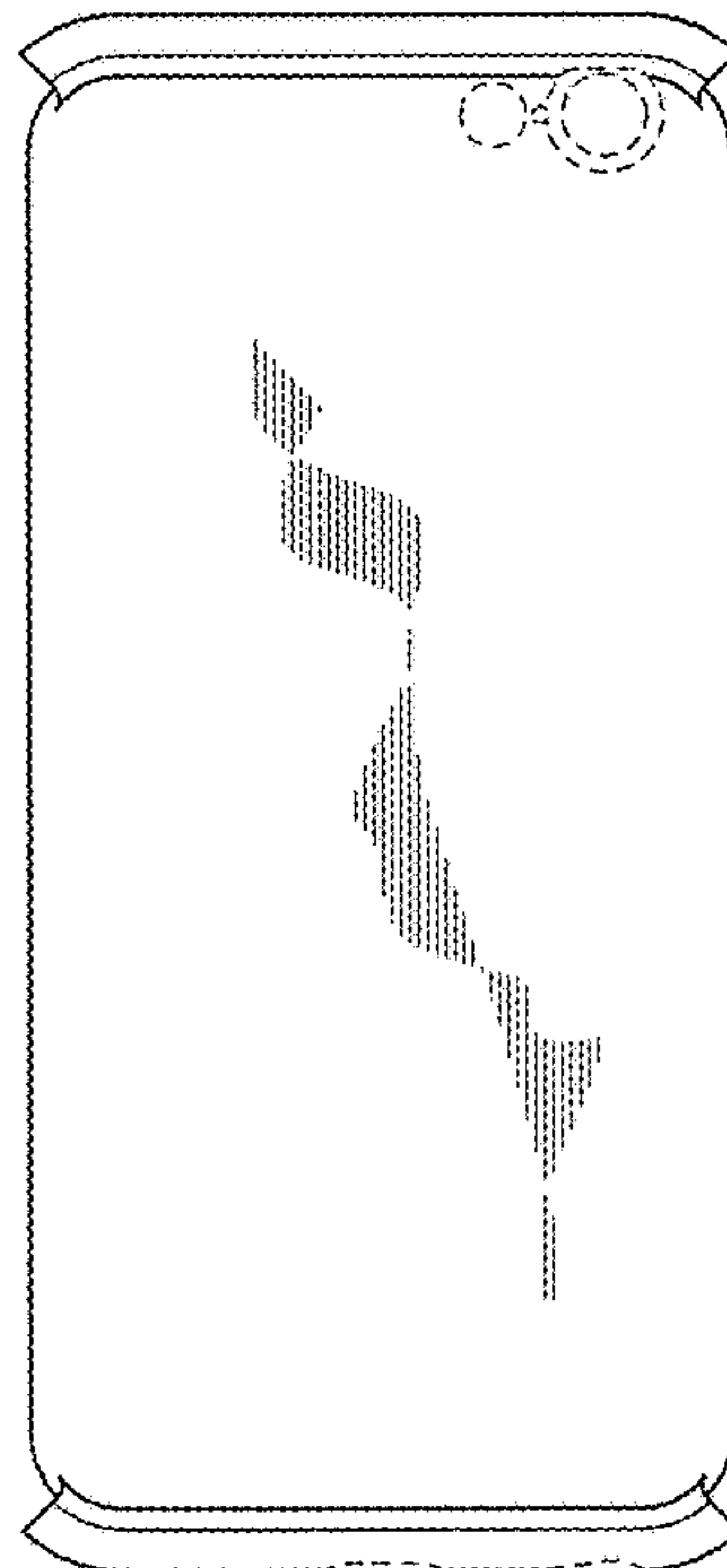

FIG. 19



FIG. 20



FIG. 21

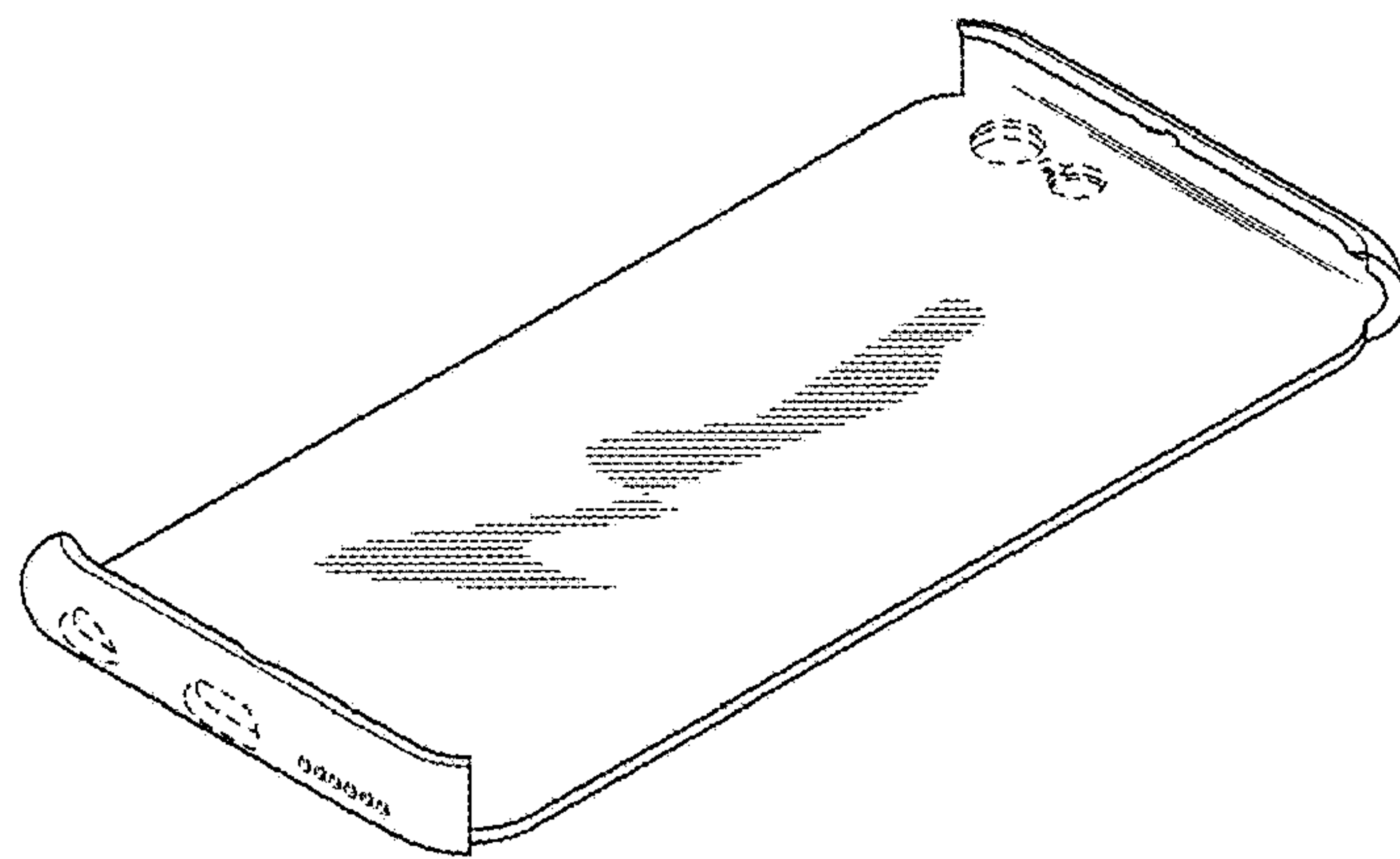

FIG. 22

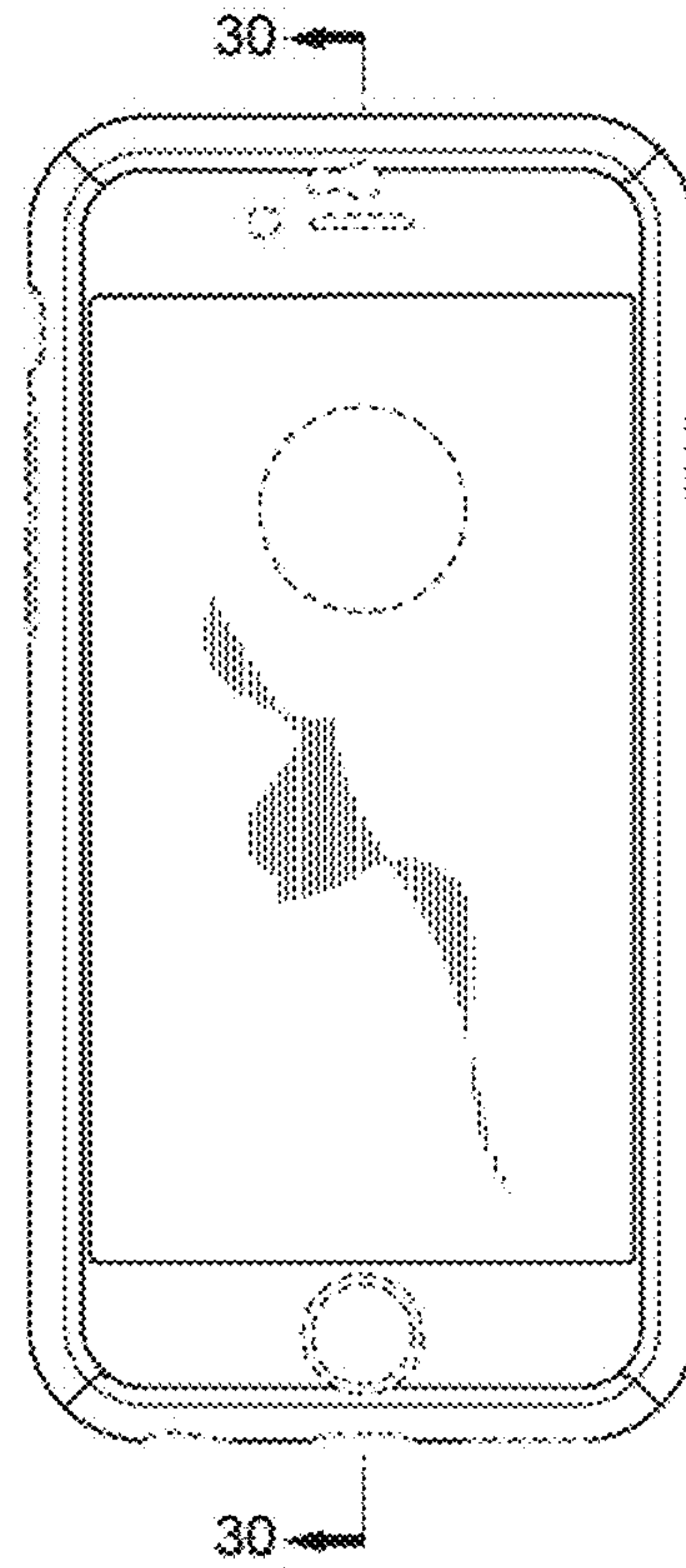

FIG. 23

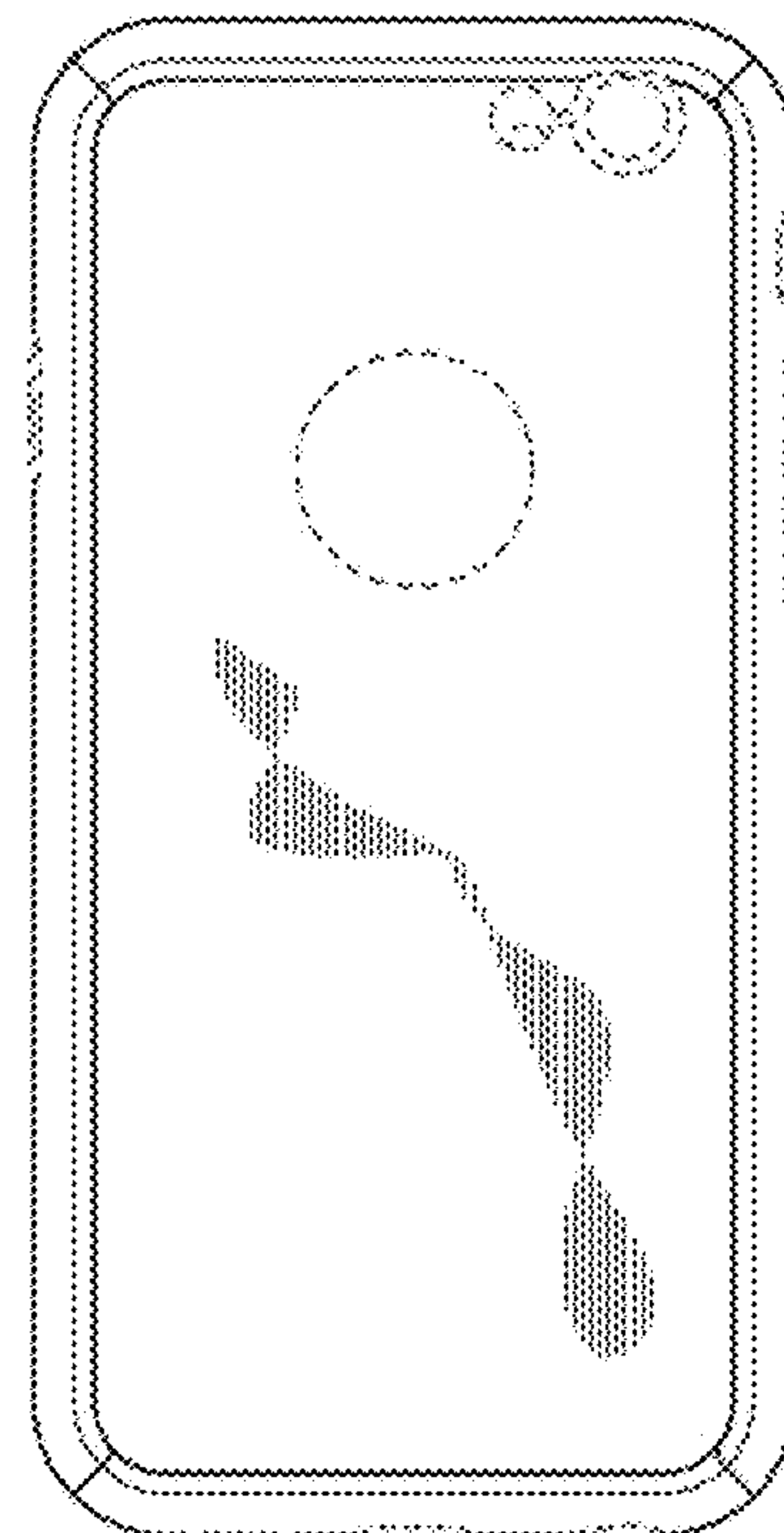

FIG. 24



FIG. 25

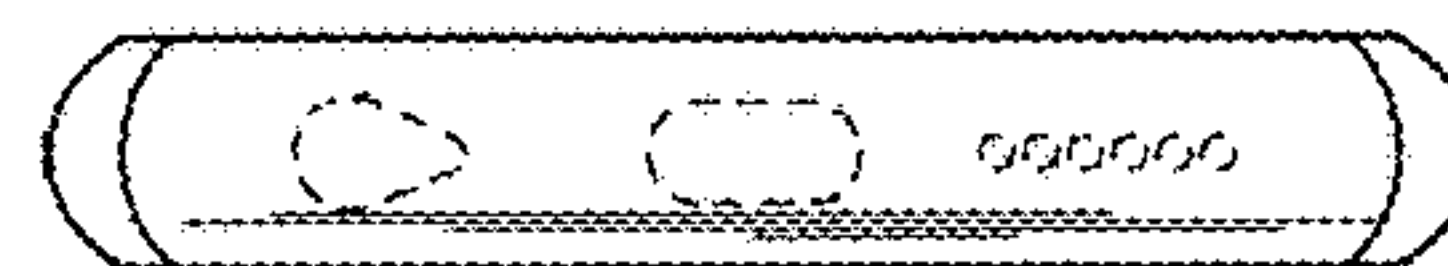

FIG. 26



FIG. 27

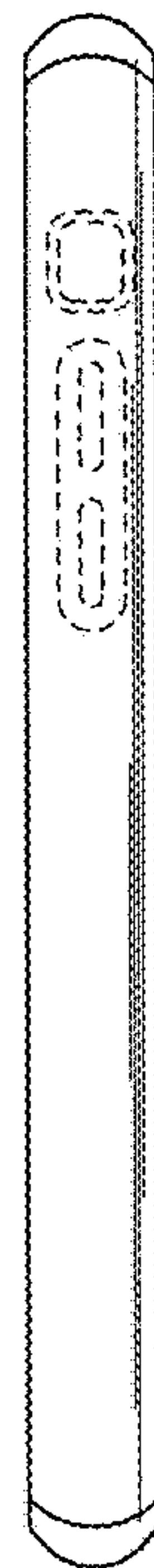

FIG. 28

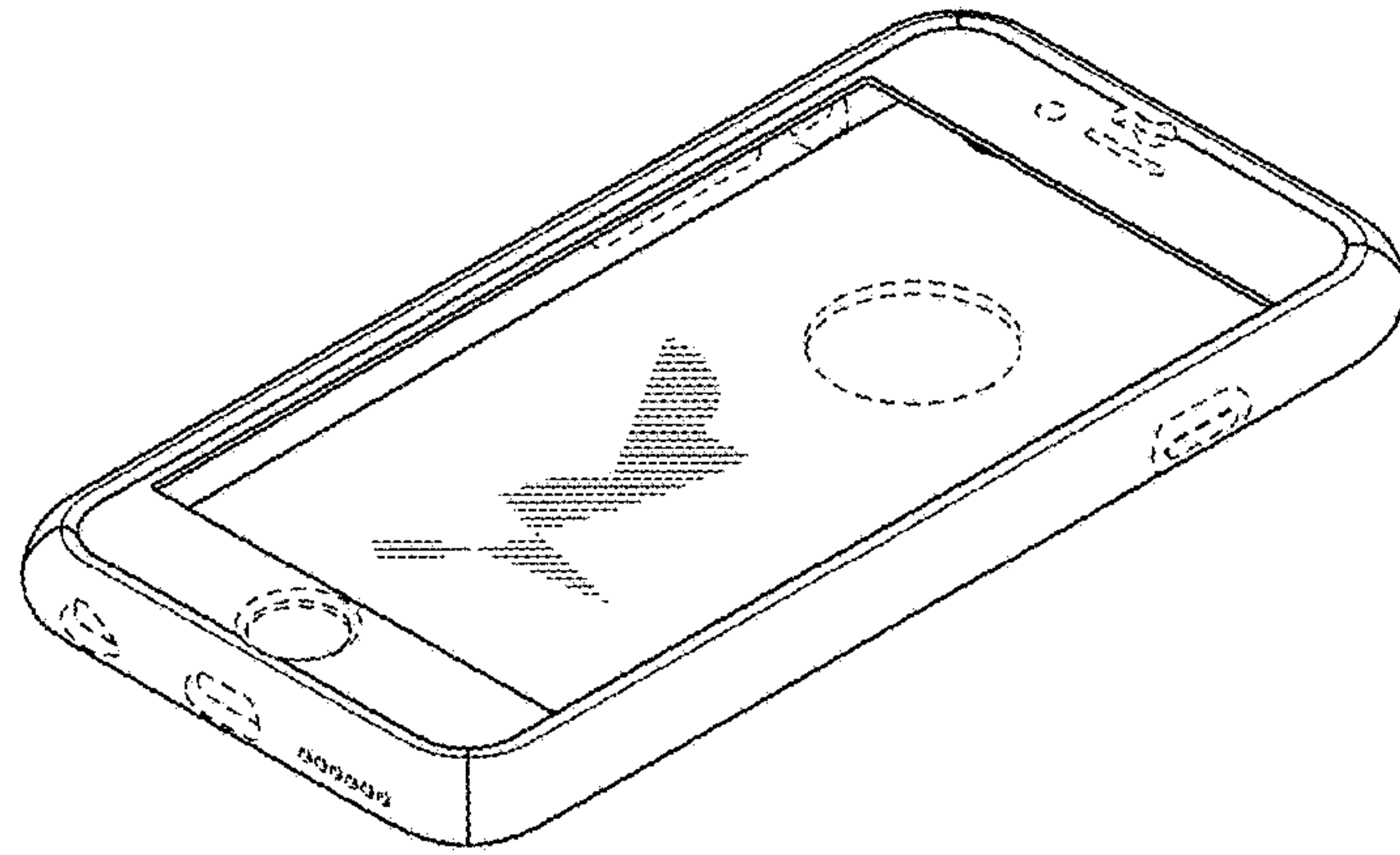

FIG. 29

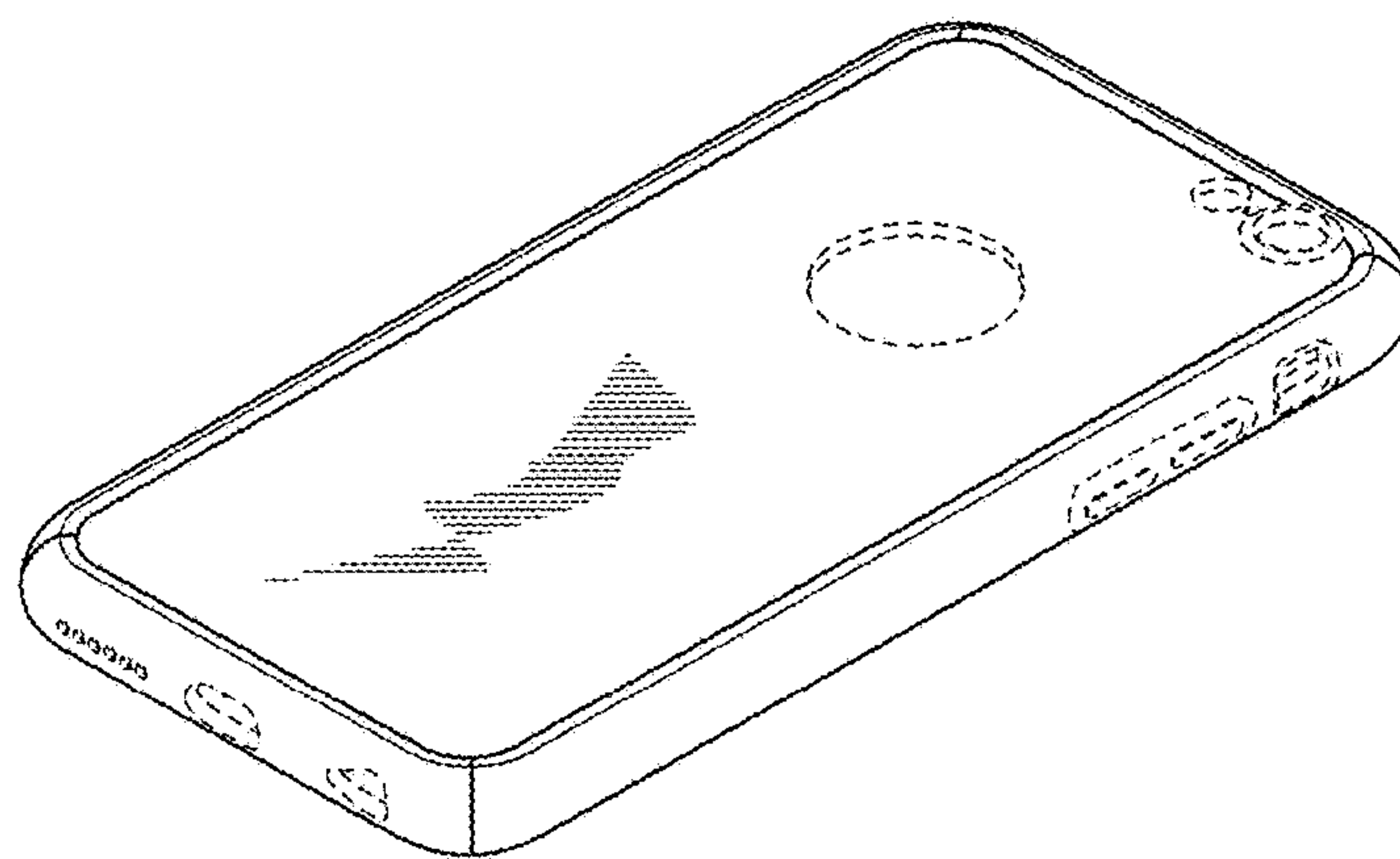

FIG. 30

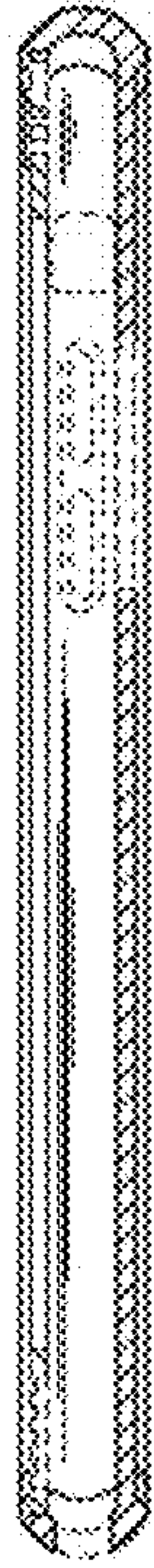

FIG. 31

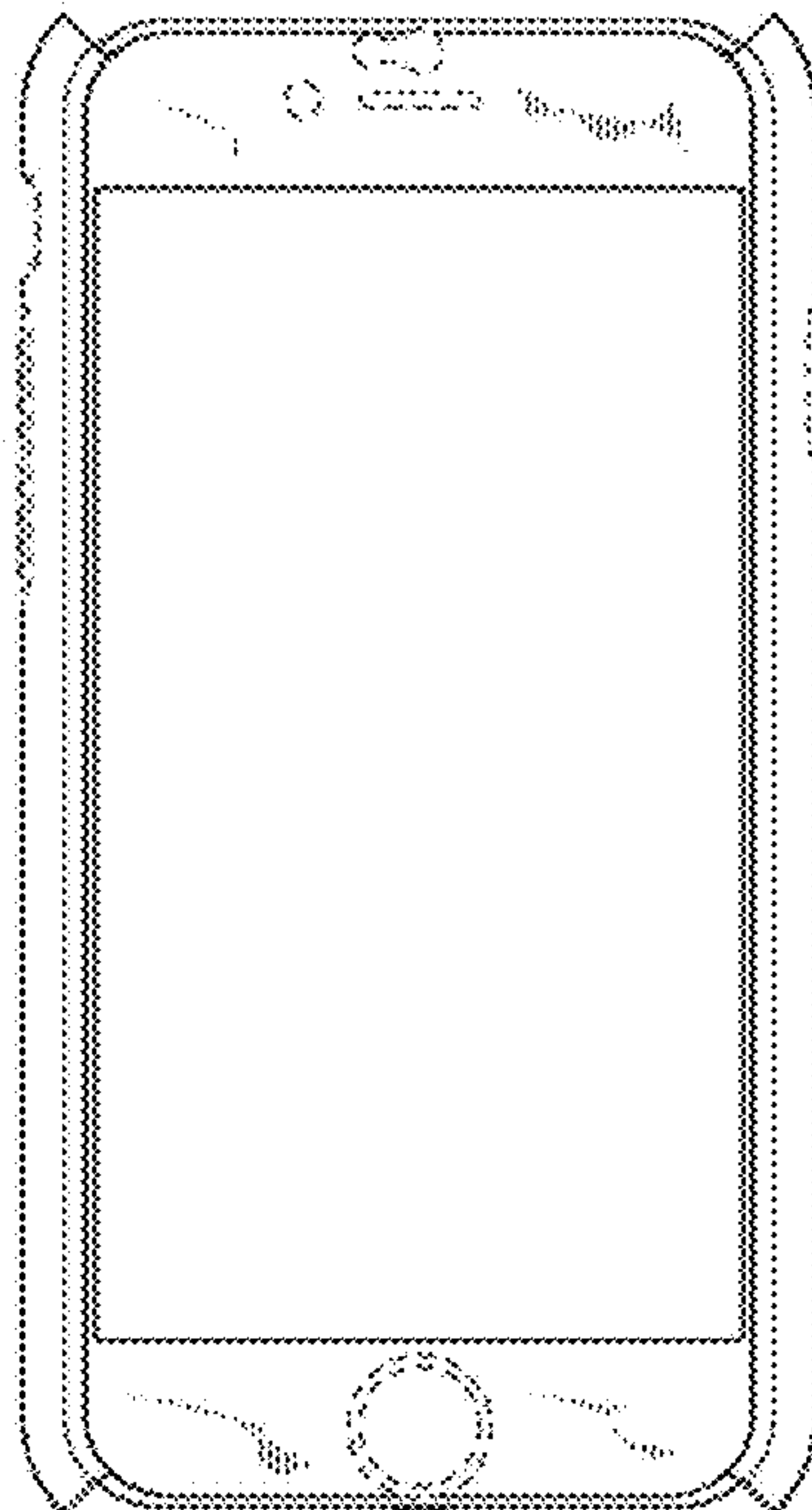

FIG. 32

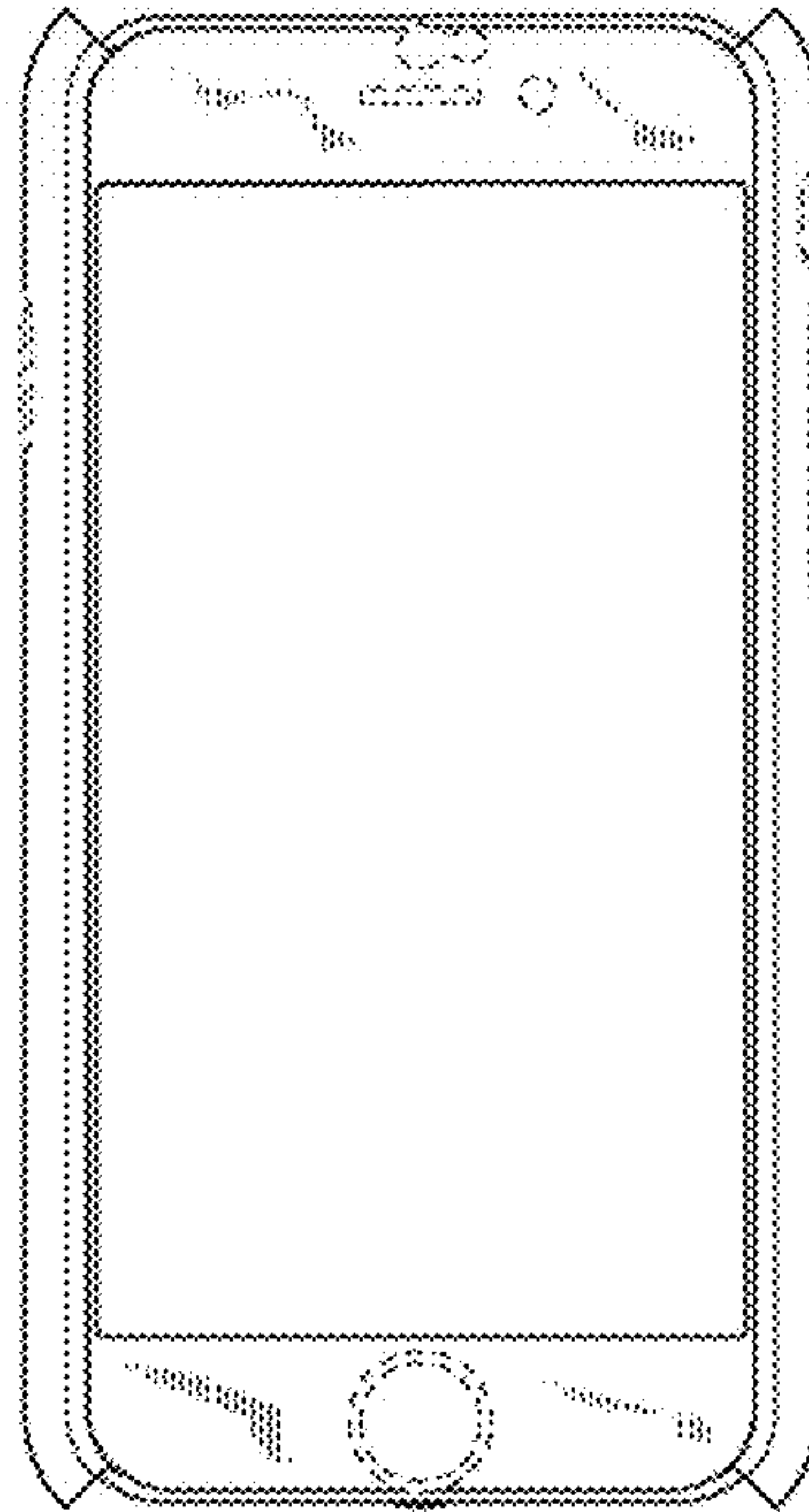

FIG. 33



FIG. 34

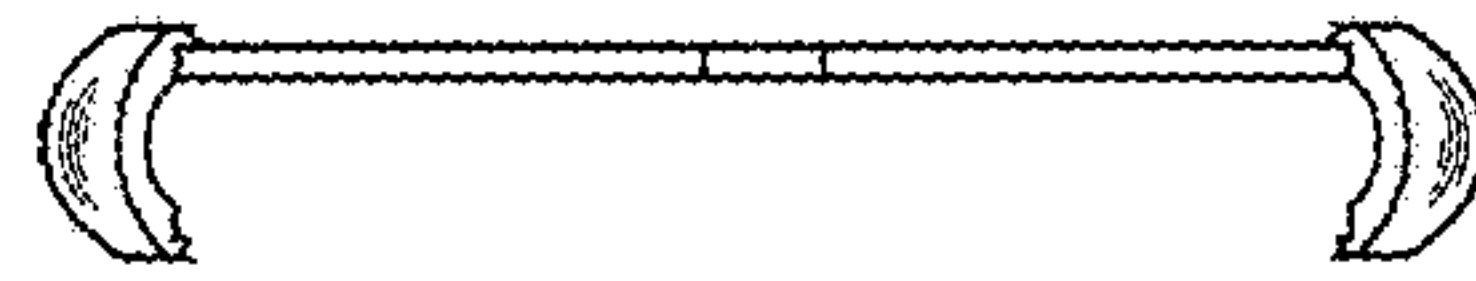

FIG. 35



FIG. 36



FIG. 37

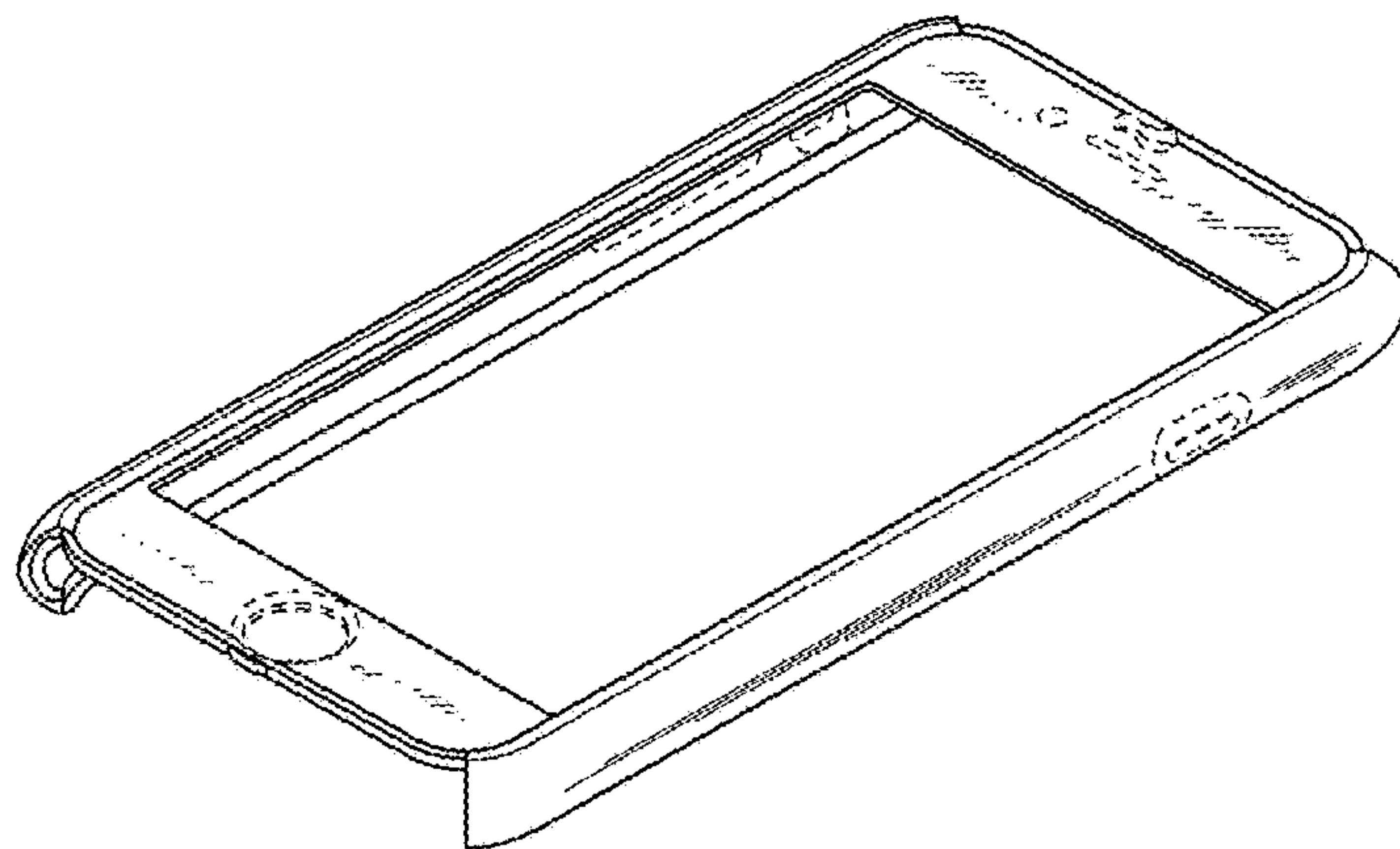

FIG. 38

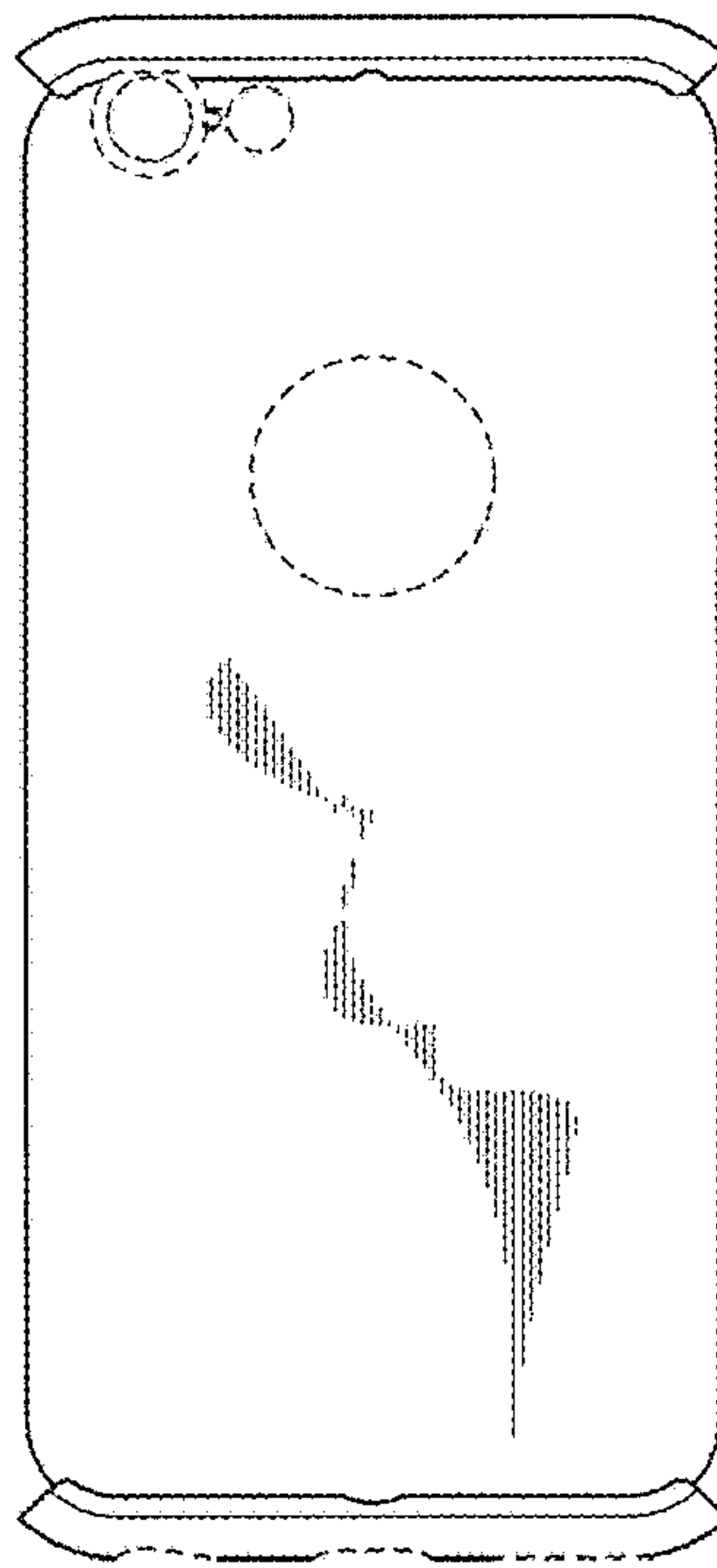

FIG. 39

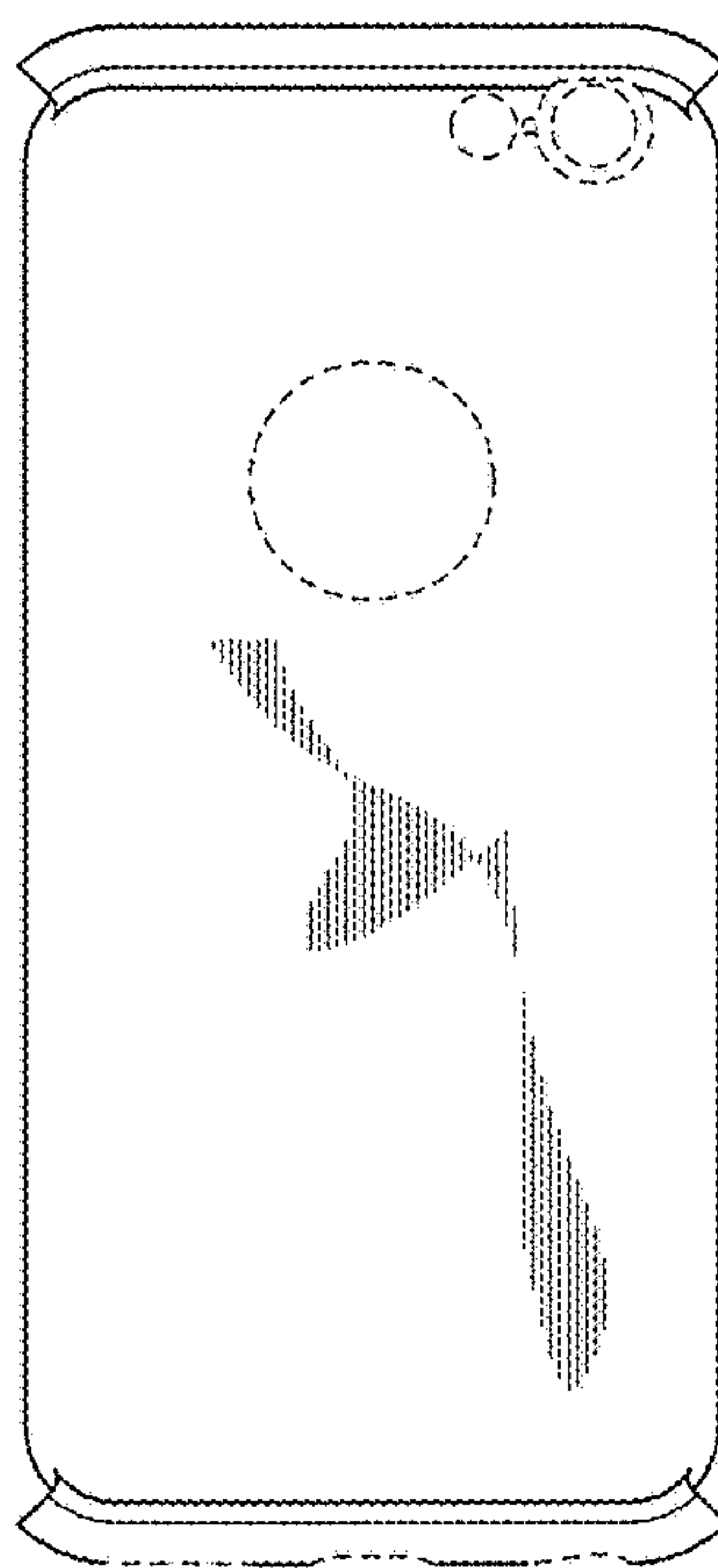

FIG. 40



FIG. 41



FIG. 42

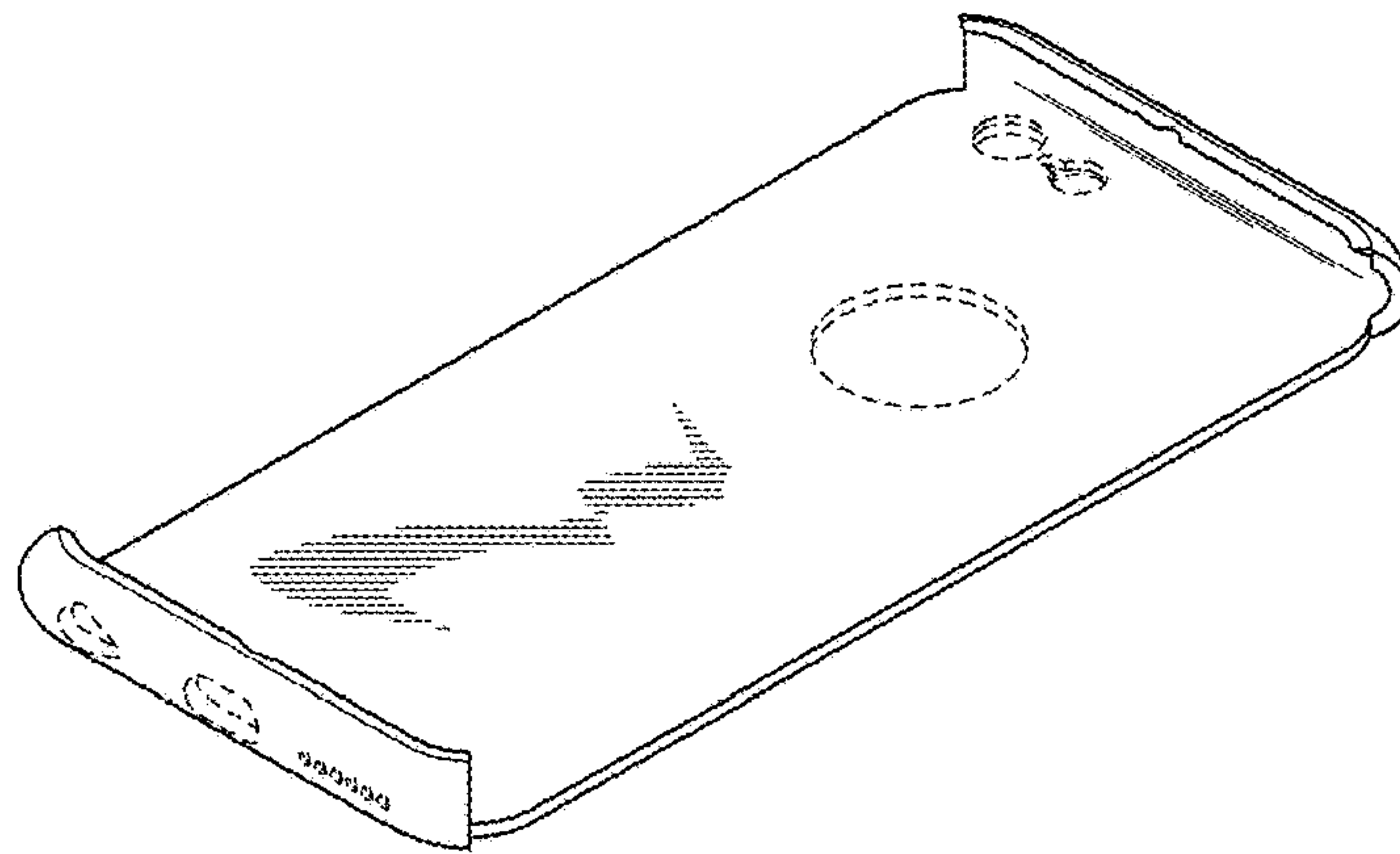

FIG. 43

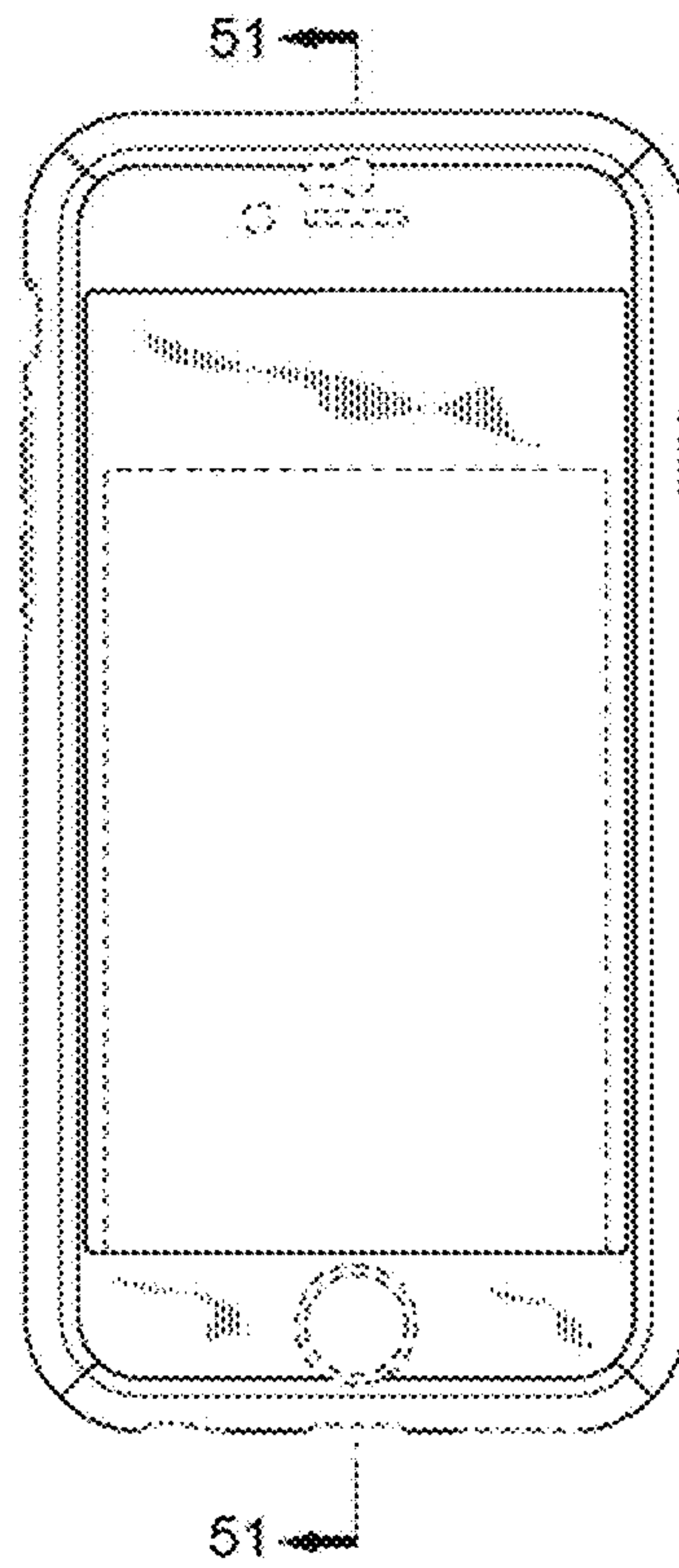

FIG. 44

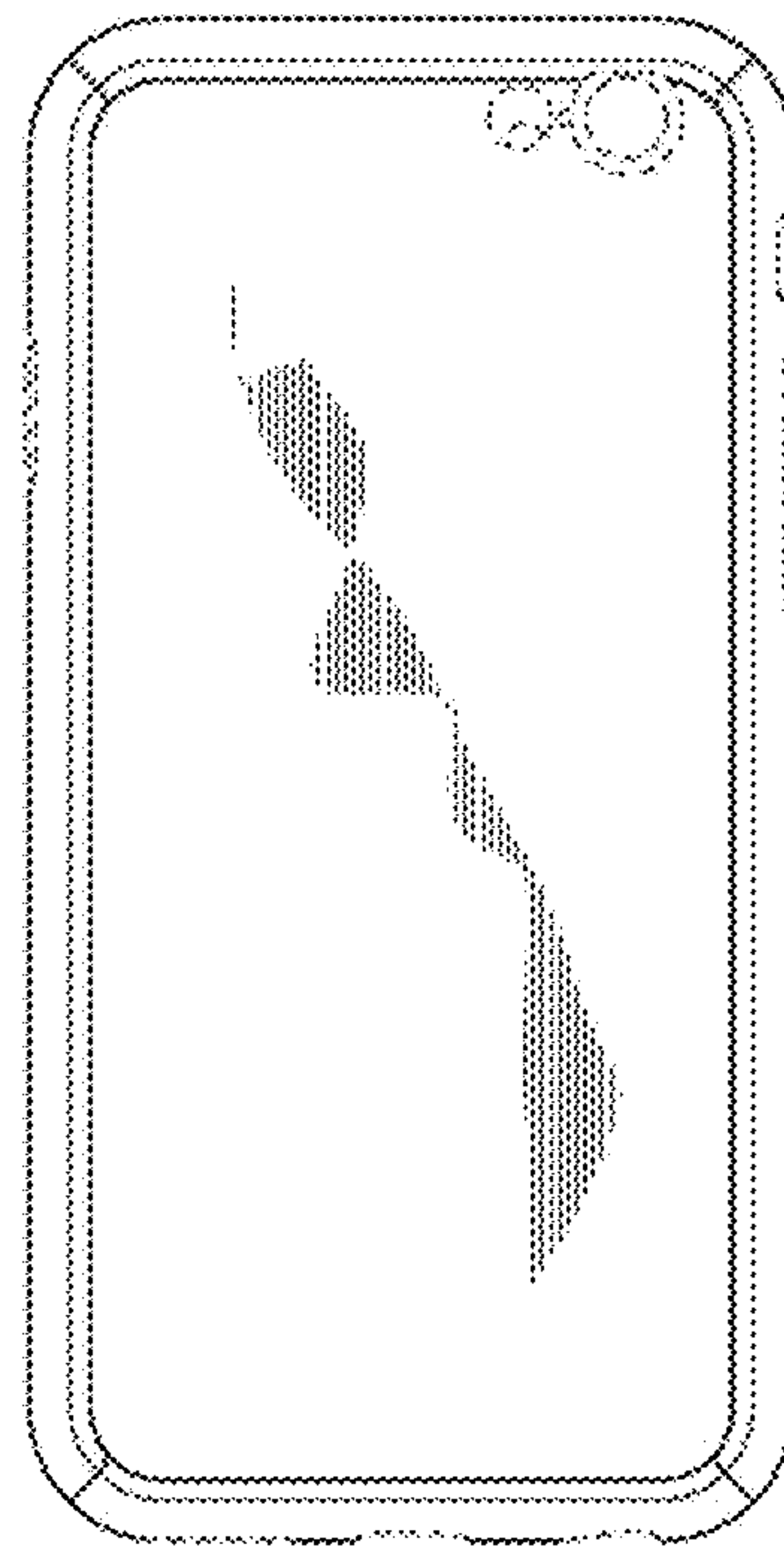

FIG. 45



FIG. 46



FIG. 47



FIG. 48

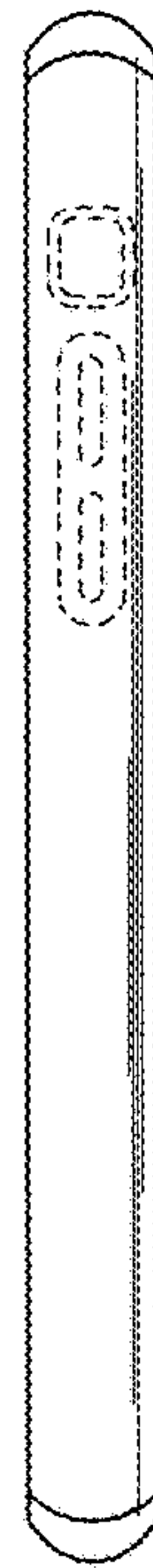

FIG. 49

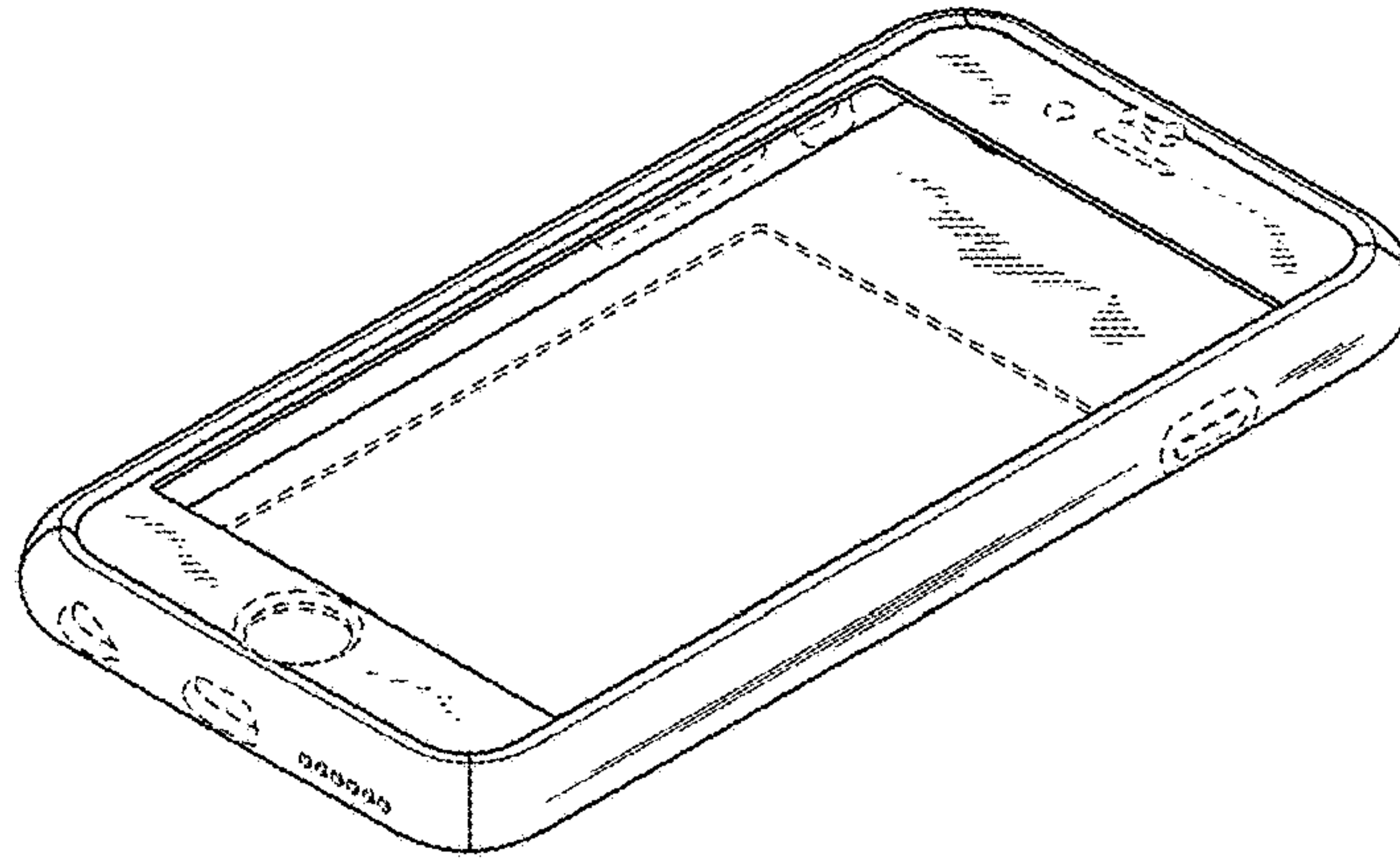

FIG. 50

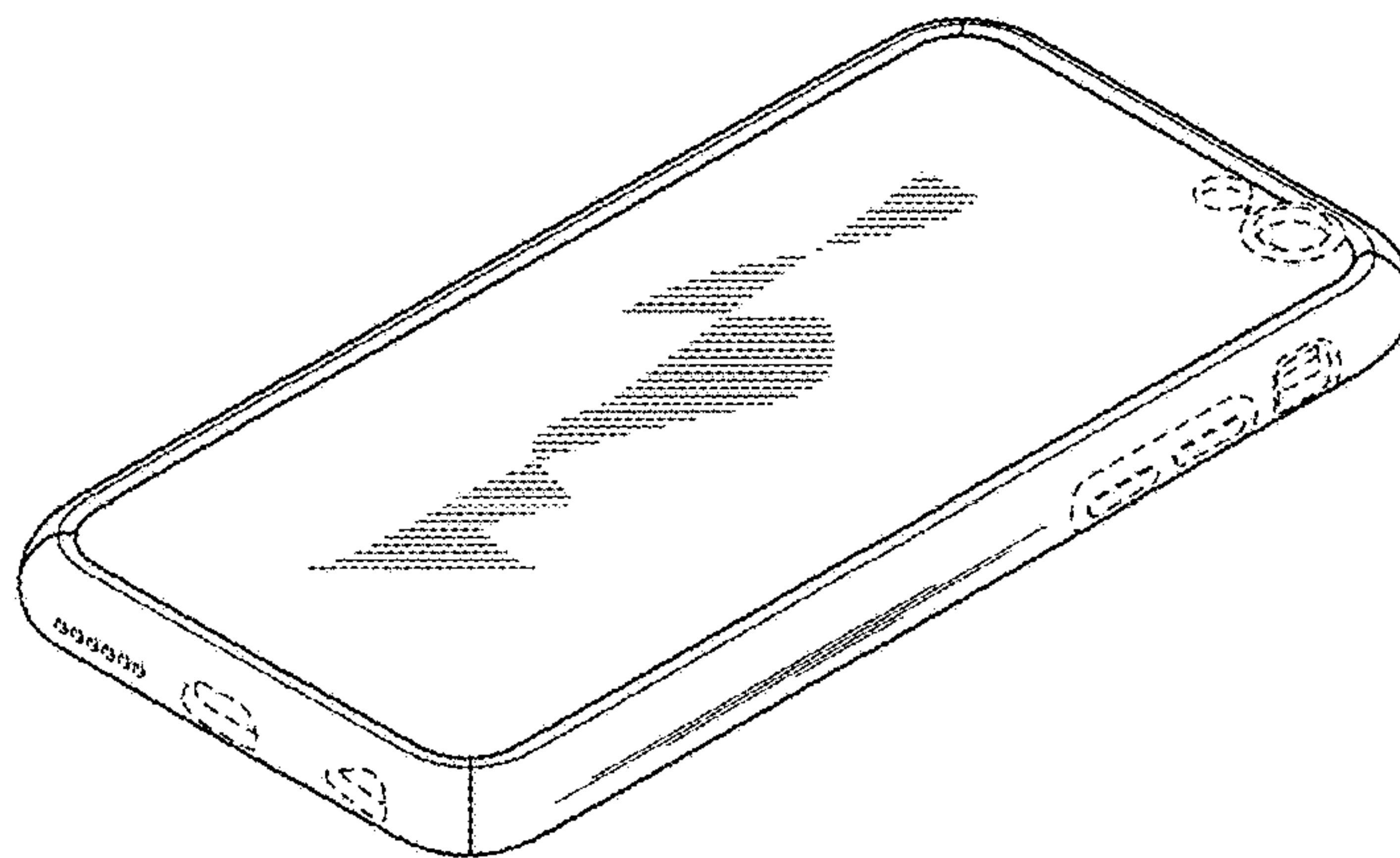

FIG. 51



FIG. 52

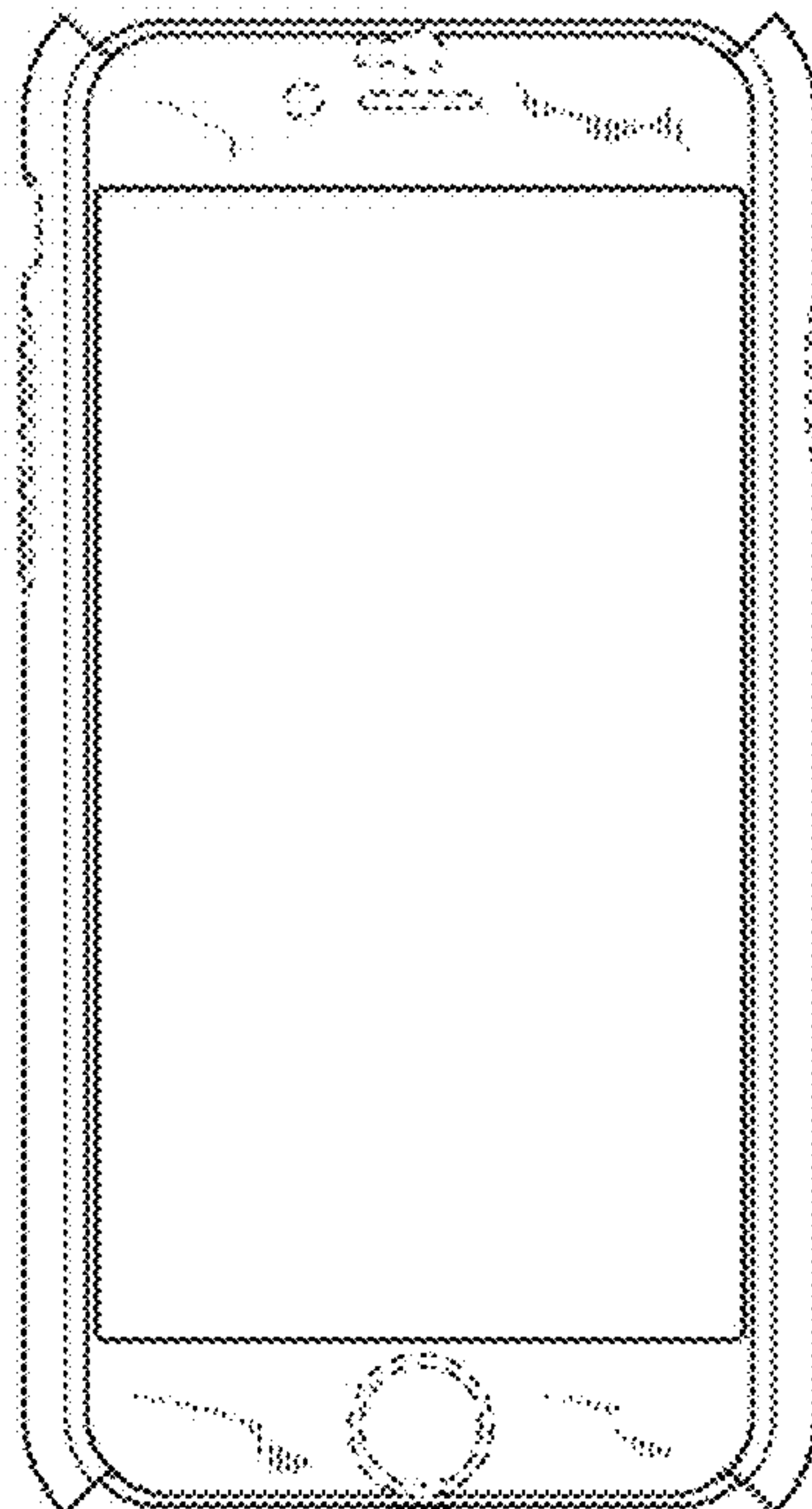

FIG. 53

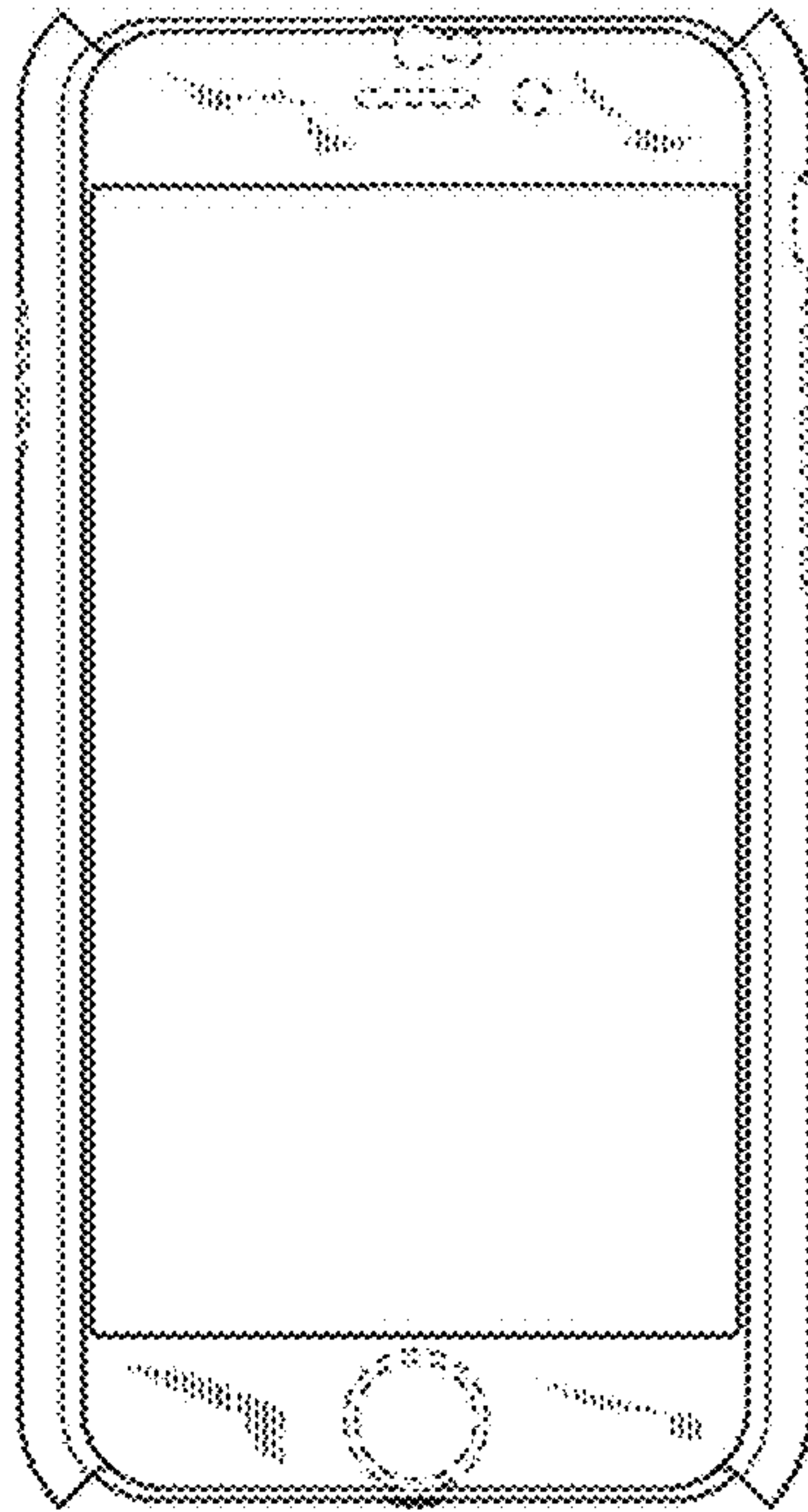

FIG. 54

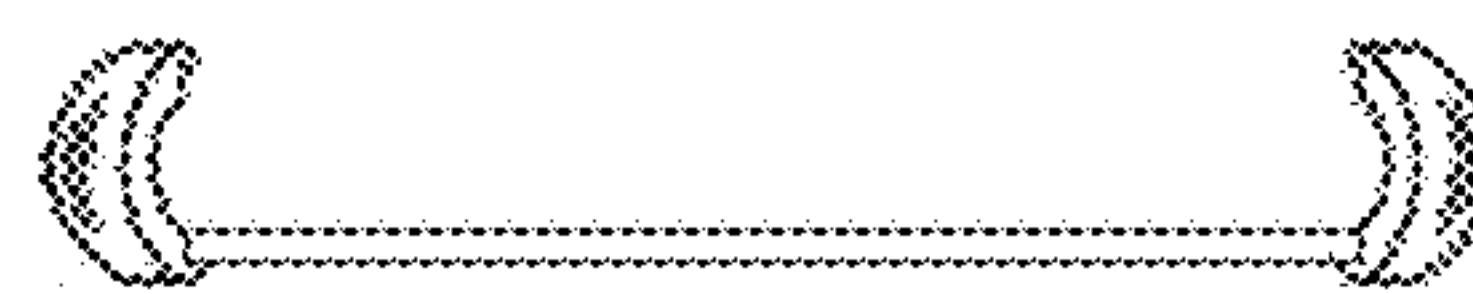

FIG. 55

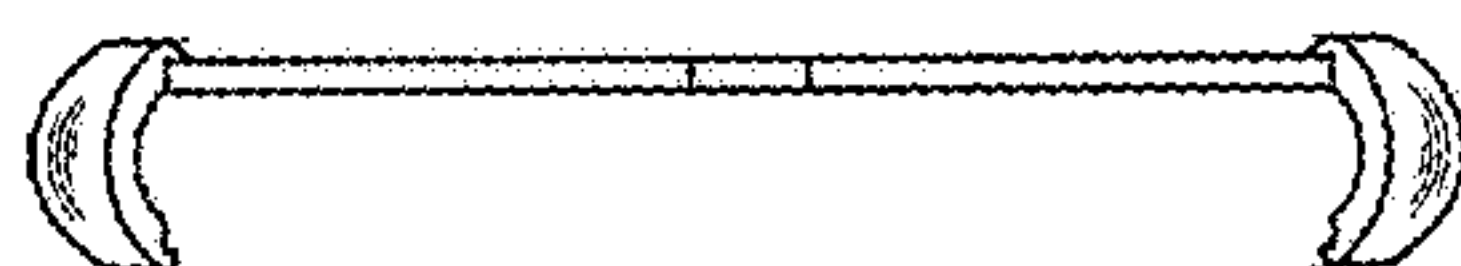

FIG. 56

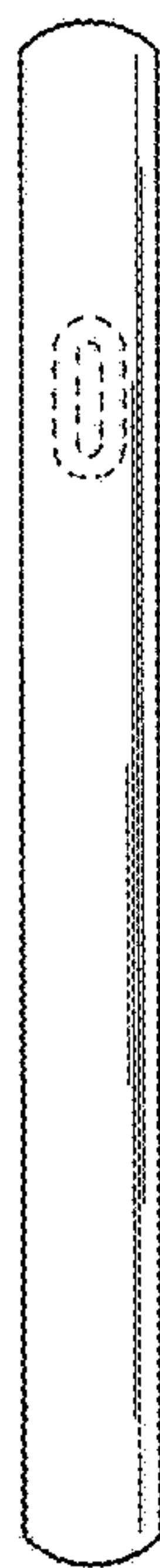

FIG. 57



FIG. 58

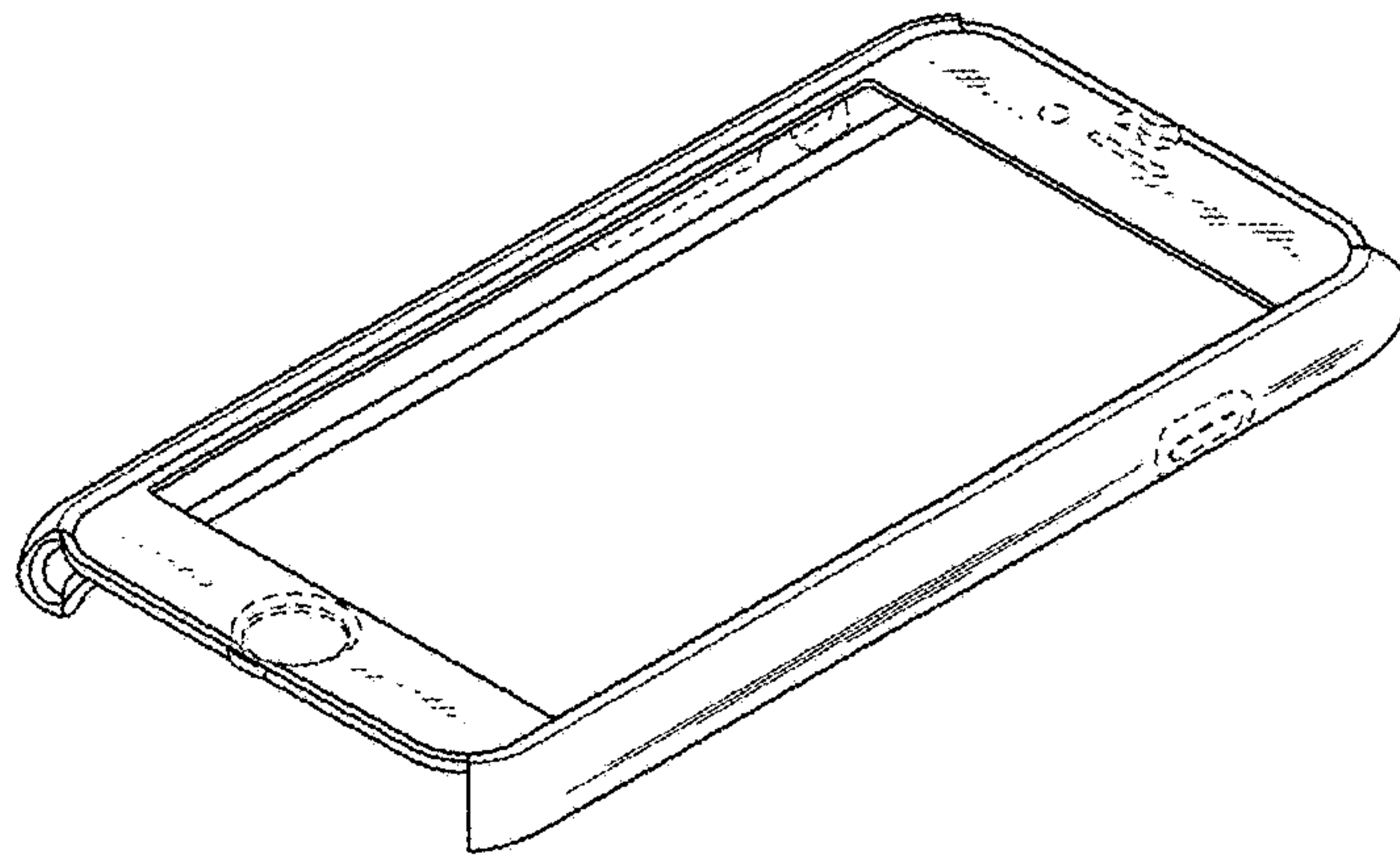

FIG. 59

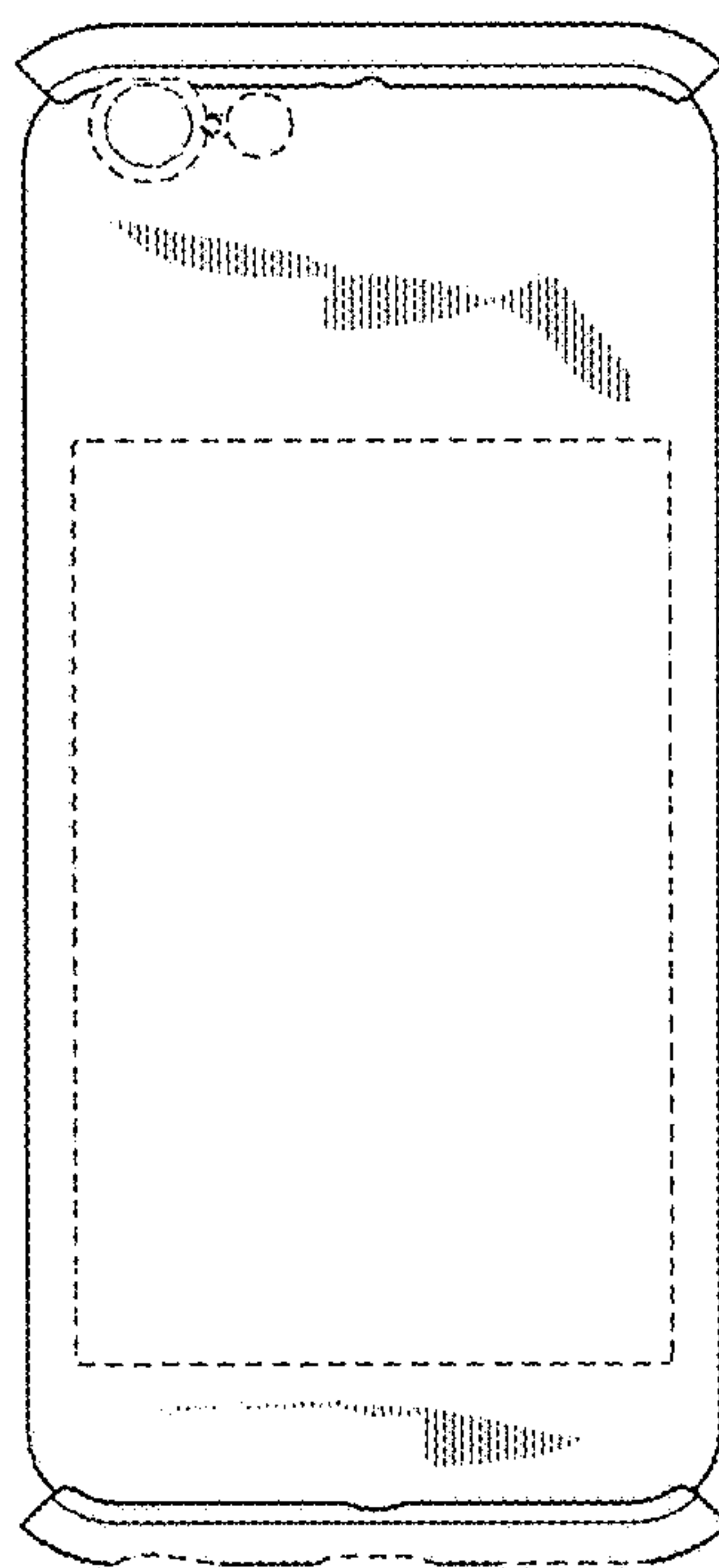

FIG. 60

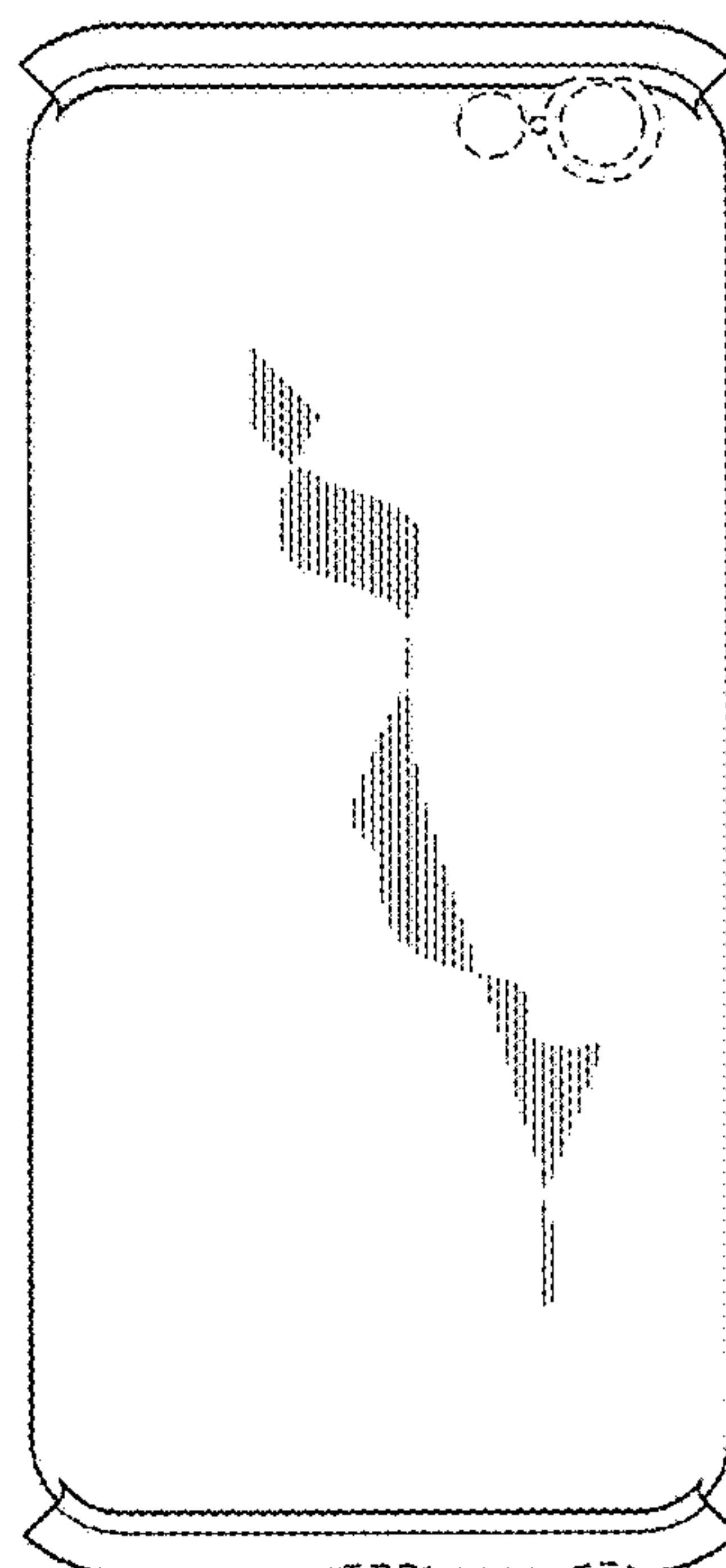

FIG. 61

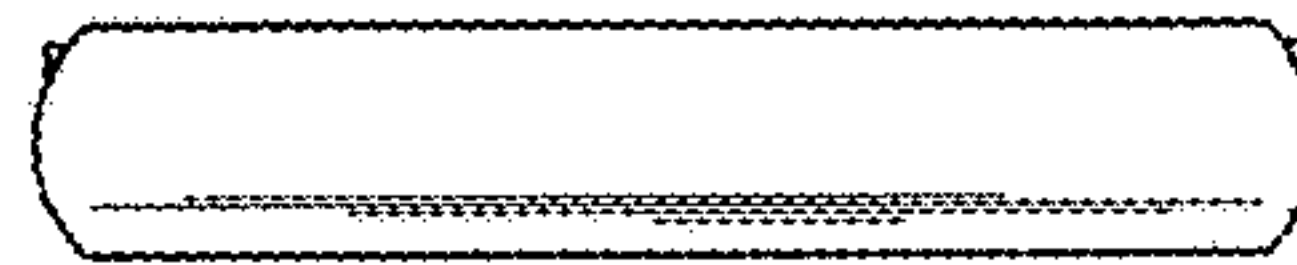

FIG. 62



FIG. 63

