



US00D842282S

(12) **United States Design Patent**  
**Lee et al.**

(10) **Patent No.:** **US D842,282 S**  
(45) **Date of Patent:** **\*\* Mar. 5, 2019**

(54) **STAND FOR TELEVISION RECEIVER**

D720,316 S \* 12/2014 Huh ..... D14/126  
D730,332 S \* 5/2015 Kumano ..... D14/239  
D743,921 S \* 11/2015 Lv ..... D14/126

(71) Applicant: **SAMSUNG ELECTRONICS CO., LTD.**, Suwon-si, Gyeonggi-do (KR)

(72) Inventors: **Min-Hee Lee**, Seoul (KR); **Eun-Ah Kim**, Seoul (KR)

(73) Assignee: **SAMSUNG ELECTRONICS CO., LTD.**, Gyeonggi-Do (KR)

(\*\*) Term: **15 Years**

(21) Appl. No.: **29/626,195**

(22) Filed: **Nov. 15, 2017**

(30) **Foreign Application Priority Data**

May 18, 2017 (KR) ..... 30-2017-0022432

(51) **LOC (11) Cl.** ..... **14-03**

(52) **U.S. Cl.**  
USPC ..... **D14/239**

(58) **Field of Classification Search**

USPC ..... D14/125-134, 239, 371, 136, 374-377,  
D14/440, 450, 448, 336, 342, 159;  
312/7.2; 348/836, 838, 180, 184, 325,  
348/739; 248/917-924, 465; 345/104,  
345/133, 156, 168, 87, 173; D21/329,  
D21/515, 577, 622, 333, 433, 448, 452,  
D21/450, 331, 505; D10/15, 26;  
446/484, 175, 356; D6/477, 479, 300;  
D24/185; D34/14  
CPC ... G06F 1/1601; G06F 1/1643; H05K 5/0004;  
H05K 5/0017; H05K 5/02; H05K 5/0217  
See application file for complete search history.

(56) **References Cited**

**U.S. PATENT DOCUMENTS**

D525,953 S \* 8/2006 Anzures ..... D14/126  
D649,950 S 12/2011 Chiu

**FOREIGN PATENT DOCUMENTS**

JP D1447210 S 1/2013  
KR 300757710 S 8/2014  
KR 300759865 S 9/2014  
KR 300804769 S 7/2015

\* cited by examiner

*Primary Examiner* — Randall H Gholson

(74) *Attorney, Agent, or Firm* — Cantor Colburn LLP

(57) **CLAIM**

The ornamental design for a stand for television receiver, as shown and described.

**DESCRIPTION**

FIG. 1 is a front perspective view of a stand for television receiver, showing our new design;  
FIG. 2 is a front view thereof;  
FIG. 3 is a rear view thereof;  
FIG. 4 is a left side view thereof;  
FIG. 5 is a right side view thereof;  
FIG. 6 is a top plan view thereof;  
FIG. 7 is a bottom plan view thereof;  
FIG. 8 is an exploded bottom perspective view thereof with an unclaimed television receiver; and,  
FIG. 9 is another front perspective view thereof with the unclaimed television receiver.

The evenly spaced broken lines illustrating portions of the stand for television receiver in FIGS. 1-7 form no part of the claimed design.

The evenly spaced broken lines illustrating portions of the stand for television receiver and the television receiver itself in FIGS. 8 and 9 form no part of the claimed design.

**1 Claim, 9 Drawing Sheets**

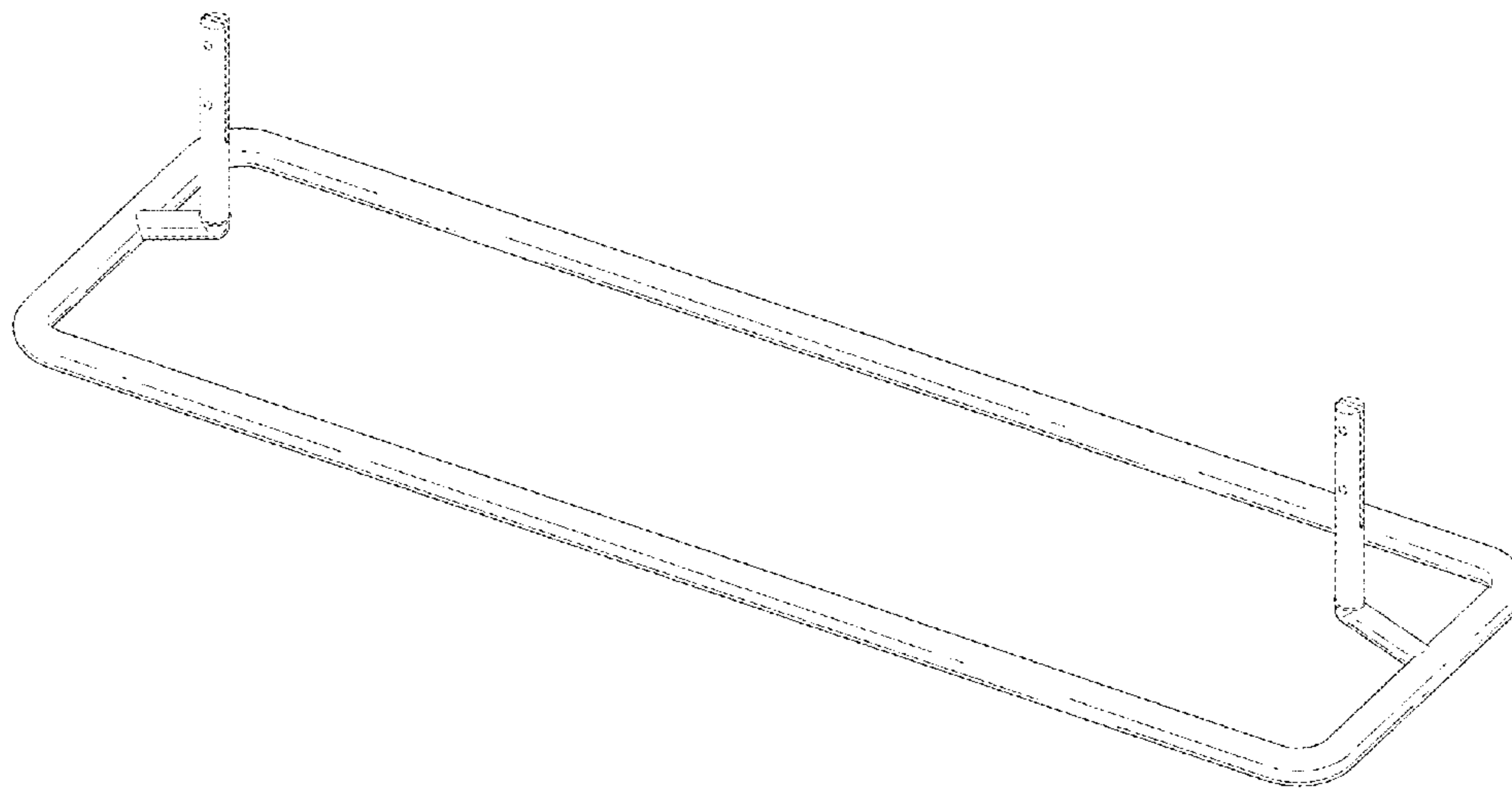

FIG. 1

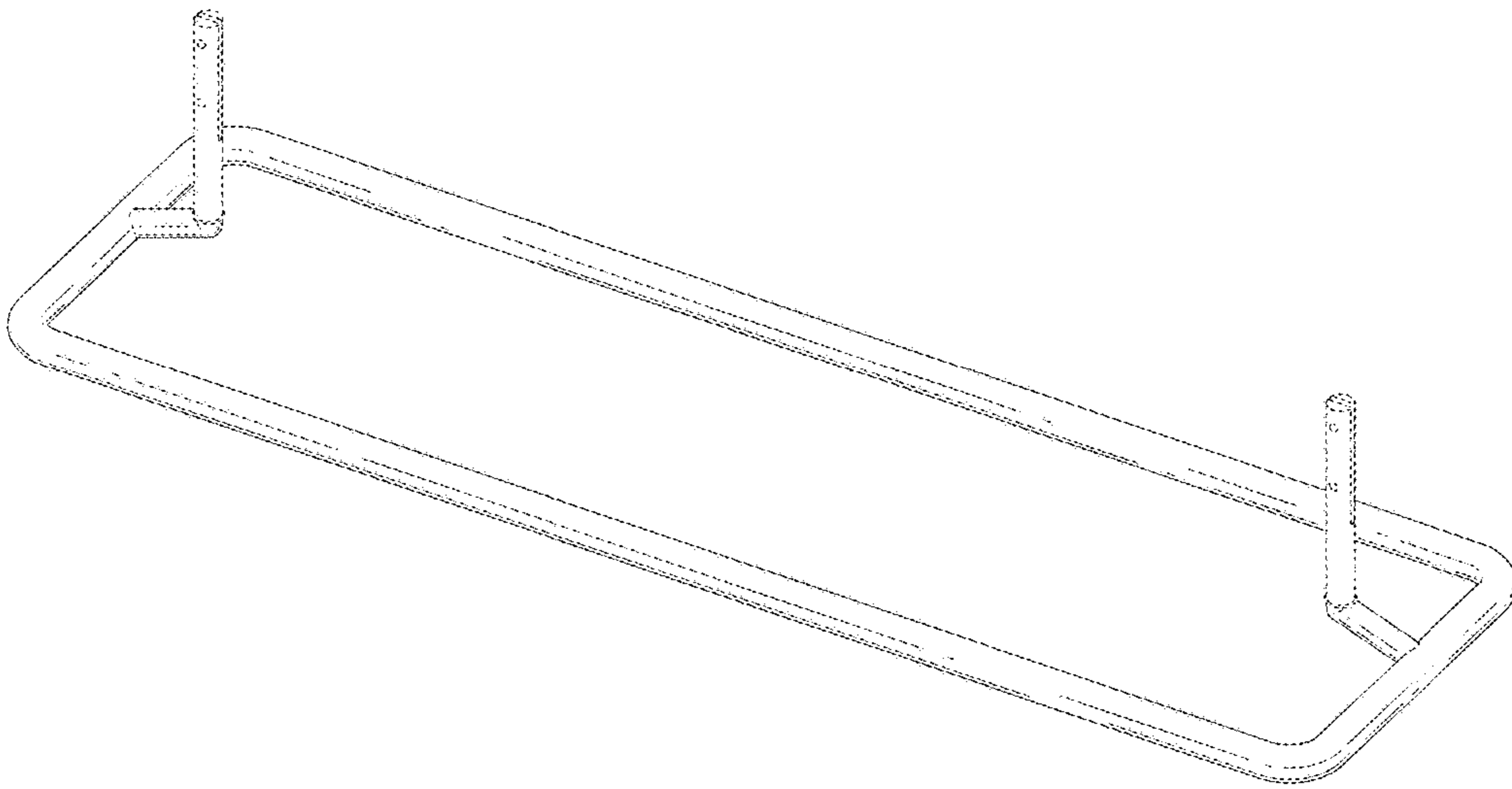

FIG. 2

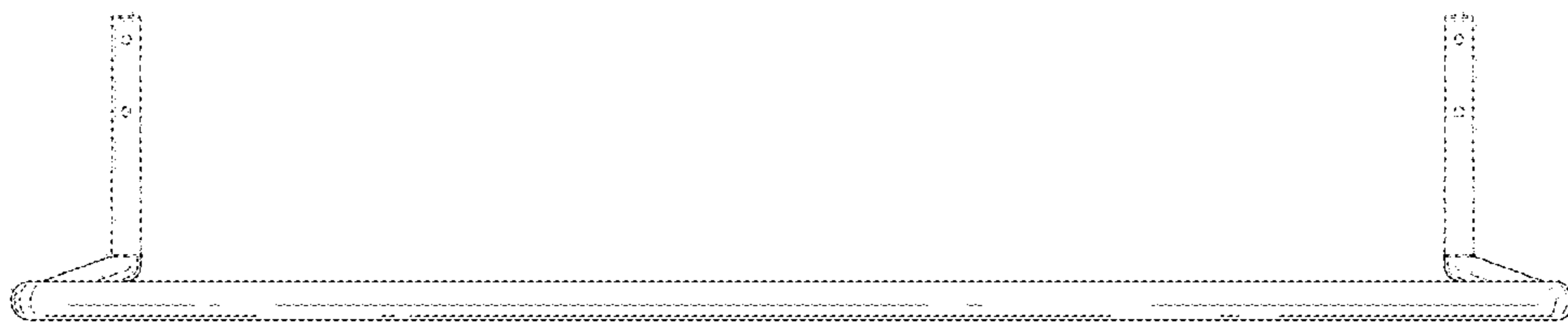

FIG. 3

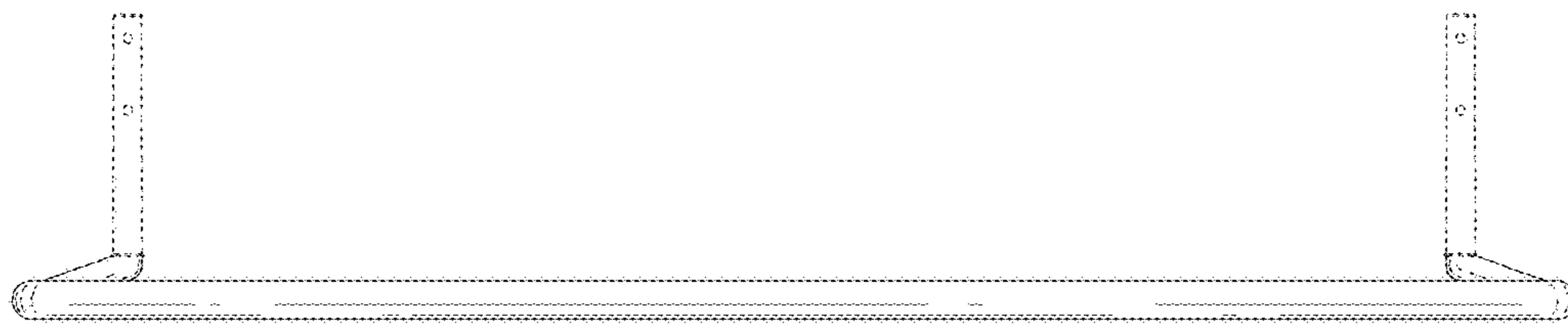

FIG. 4

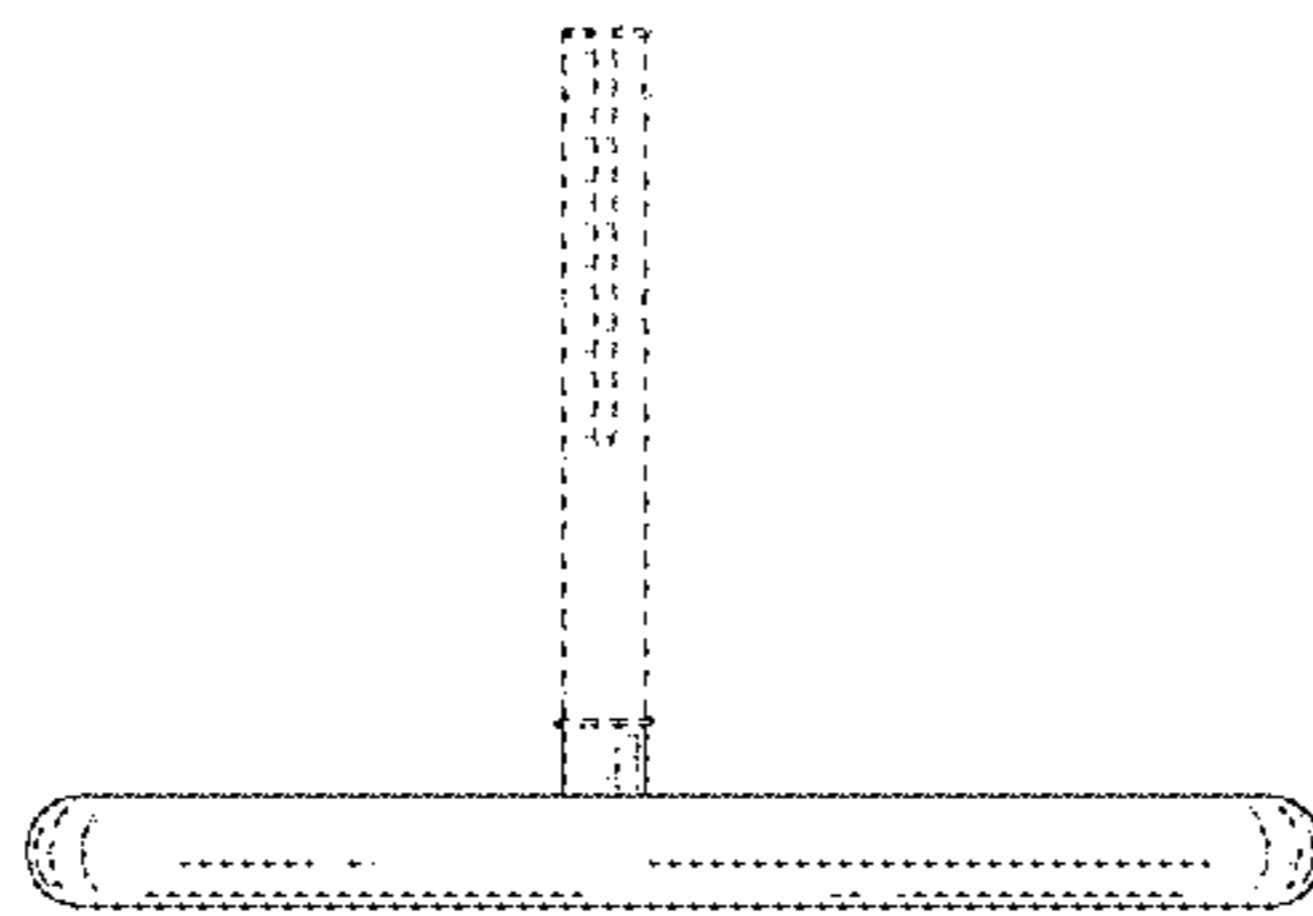

FIG. 5

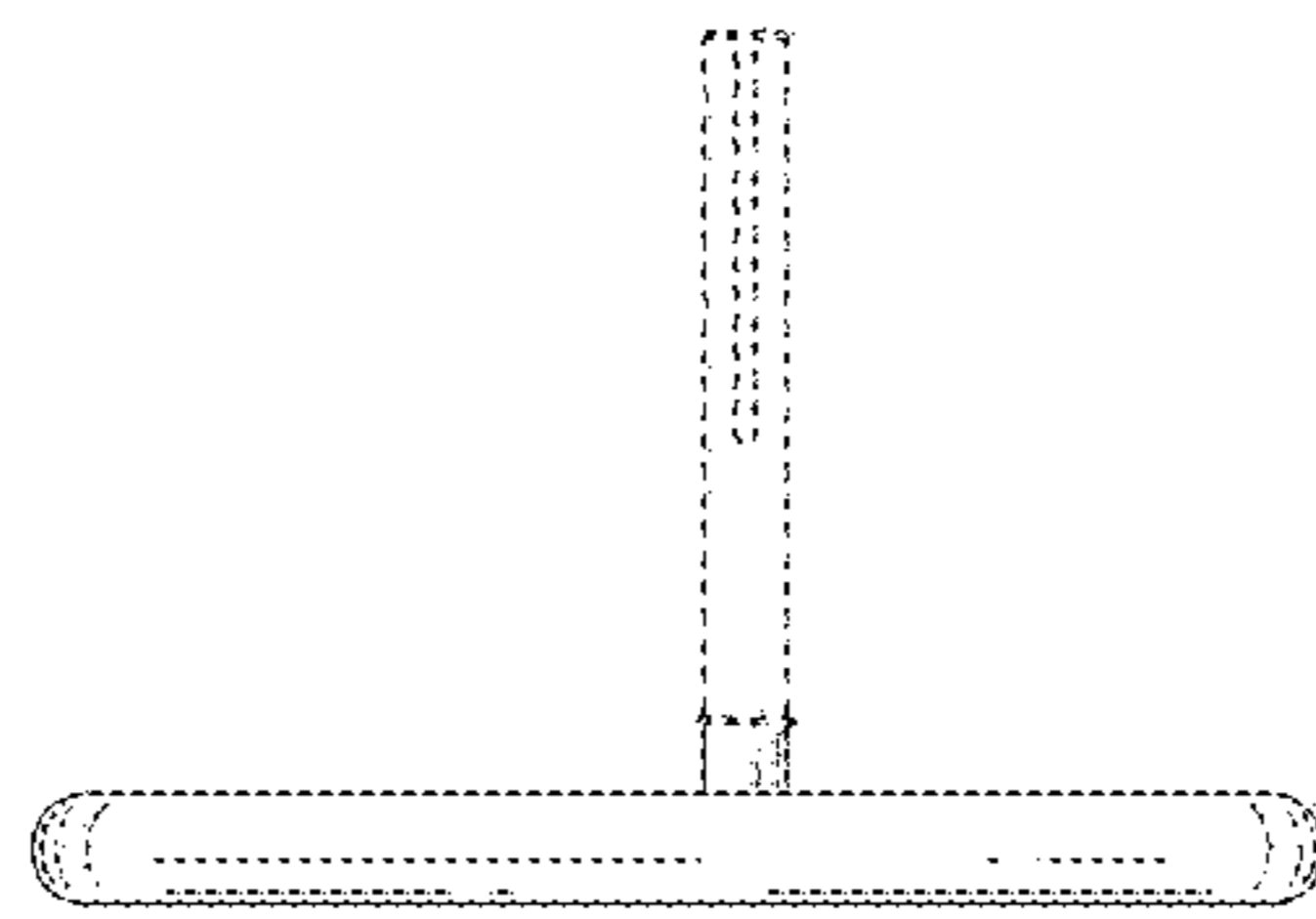

FIG. 6

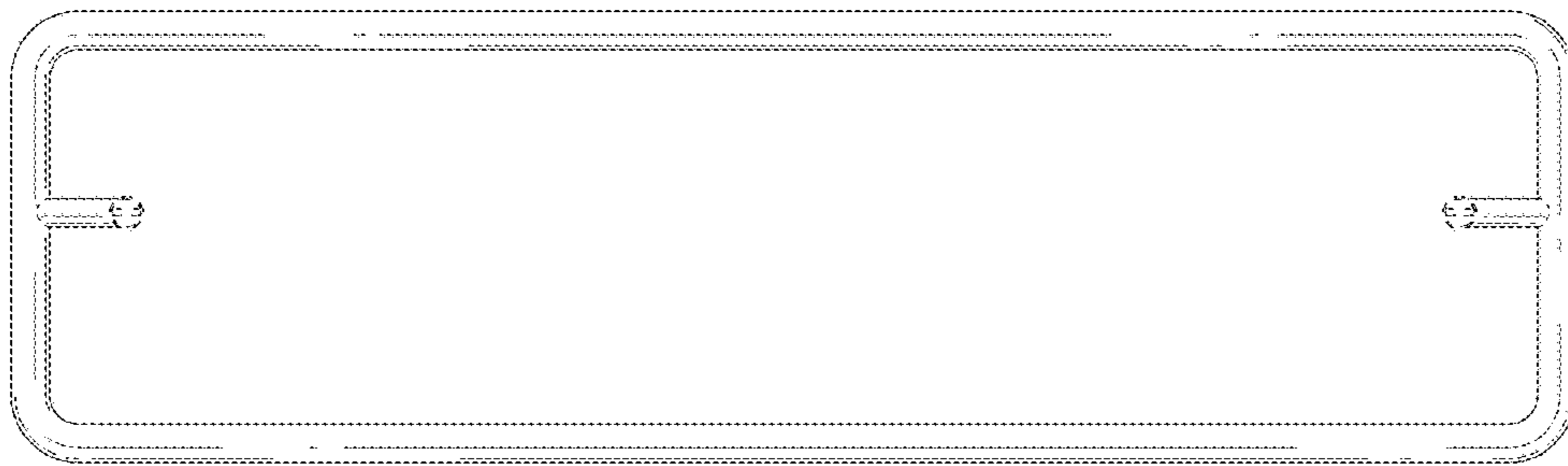

FIG. 7

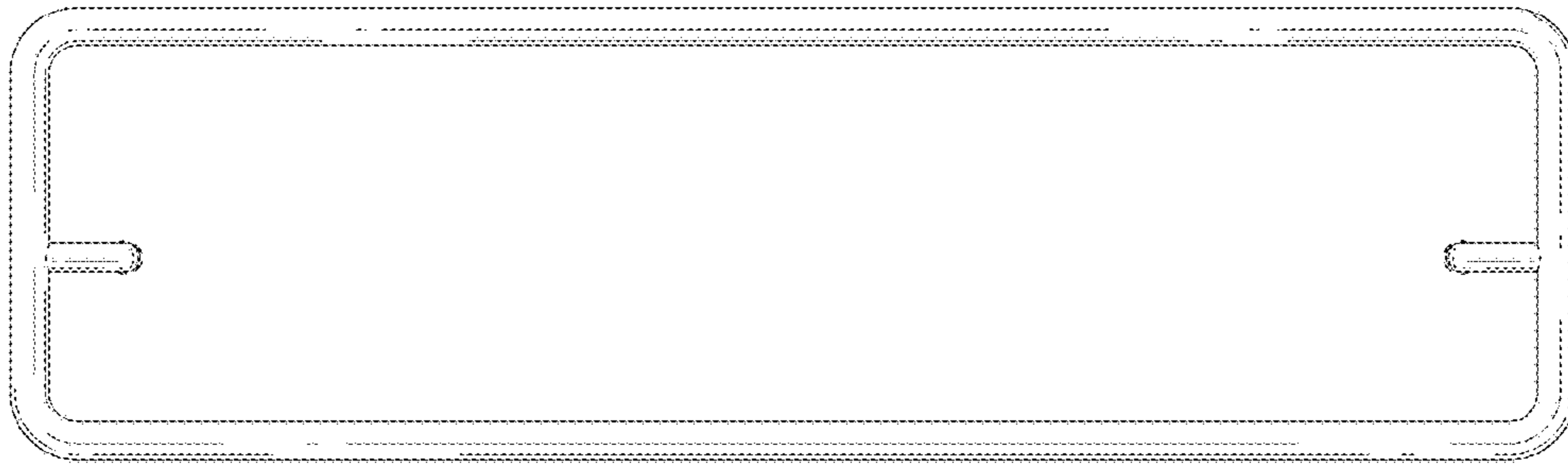



FIG. 8

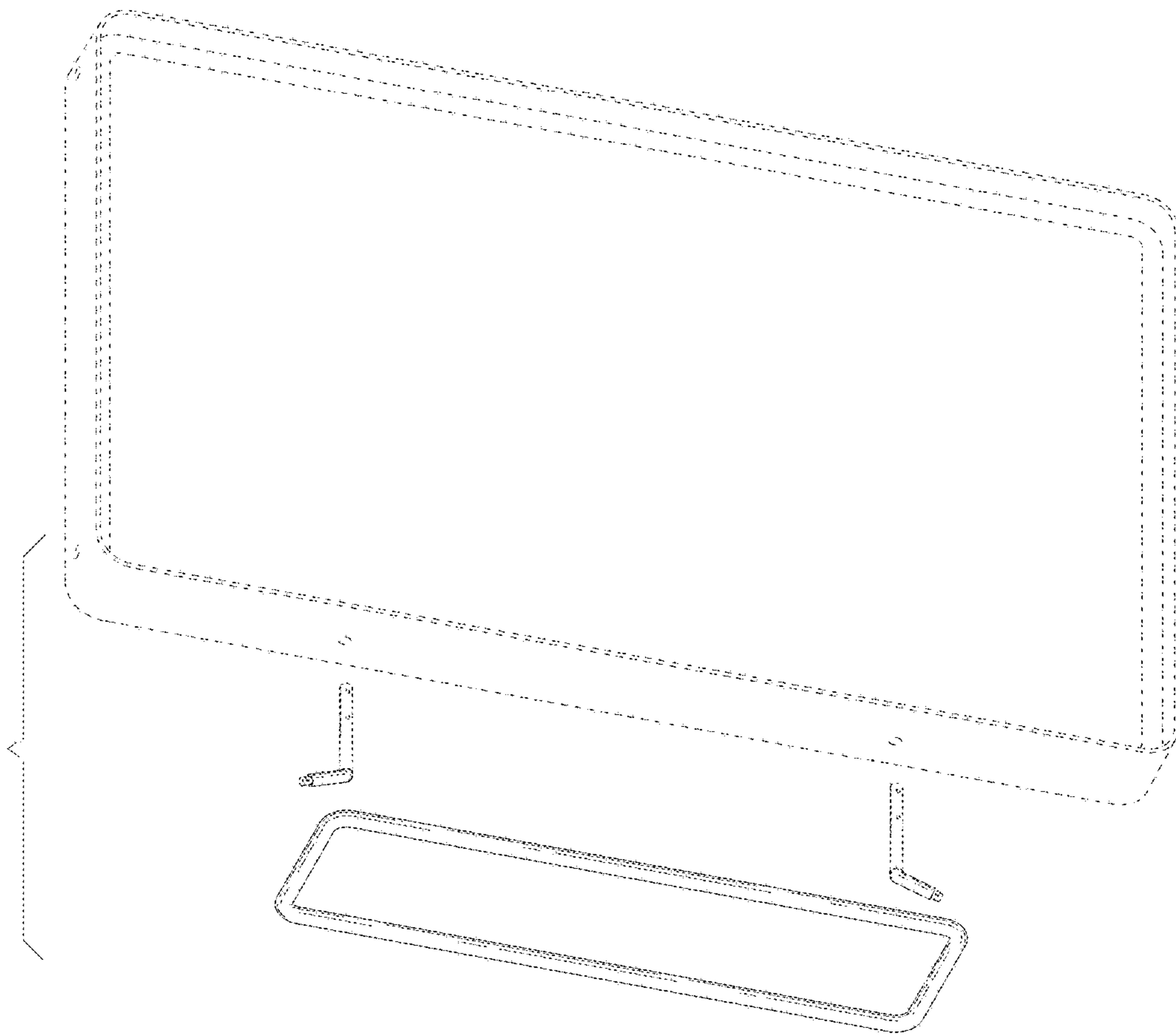

FIG. 9

