



US00D842269S

(12) **United States Design Patent**
Shin et al.

(10) **Patent No.:** **US D842,269 S**
(45) **Date of Patent:** **** Mar. 5, 2019**

- (54) **WIRELESS HEADSET**
- (71) Applicant: **SPIGEN KOREA CO., LTD.**, Seoul (KR)
- (72) Inventors: **Sang Yoon Shin**, Seoul (KR); **Chung Hae Kwon**, Seoul (KR)
- (73) Assignee: **SPIGEN KOREA CO., LTD.**, Seoul (KR)
- (**) Term: **15 Years**
- (21) Appl. No.: **29/609,109**
- (22) Filed: **Jun. 28, 2017**

- D351,598 S 10/1994 Nakamura
- D368,716 S 4/1996 Shudo
- D371,558 S 7/1996 Yoshizawa
- D381,414 S 7/1997 Westerdal
- 6,010,216 A * 1/2000 Jesiek H04B 1/385
351/158
- 6,233,345 B1 * 5/2001 Urwyler H04R 1/1033
351/123

(Continued)

OTHER PUBLICATIONS

“LG Tone Pro HBS-770 Wireless Stereo Headset—Black”, <https://www.amazon.com/dp/B01EKDVHZY>, earliest review date of Jun. 26, 2016.

(Continued)

Primary Examiner — Paula Allen Greene

(74) *Attorney, Agent, or Firm* — Heedong Chae; Lucem, PC

Related U.S. Application Data

- (63) Continuation of application No. 29/605,073, filed on May 23, 2017, now Pat. No. Des. 830,335.
- (51) **LOC (11) Cl.** **14-01**
- (52) **U.S. Cl.**
USPC **D14/205**; D14/223
- (58) **Field of Classification Search**
USPC D14/205, 223; 181/129, 130, 135;
379/430, 431; 381/380, 381, 74, 379,
381/378, 376; 455/90.3, 575.1, 569.1
CPC H04R 1/10; H04R 25/00; H04R 1/1066;
H04R 1/1016; H04R 5/033; H04R 1/105;
H04R 1/1083; H04R 1/02
See application file for complete search history.

(57) **CLAIM**

The ornamental design for wireless headset, as shown and described.

DESCRIPTION

FIG. 1 is a front perspective view of a wireless headset showing my new design;
 FIG. 2 is a rear perspective view thereof;
 FIG. 3 is a front elevational view thereof;
 FIG. 4 is a rear elevational view thereof;
 FIG. 5 is a left side elevational view thereof;
 FIG. 6 is a right side elevational view thereof;
 FIG. 7 is a top plan view thereof;
 FIG. 8 is a bottom plan view thereof; and,
 FIG. 9 is a front perspective view thereof illustrating an earbud being extended.
 The broken line showing of environment is for illustrative purposes only and forms no part of the claimed design.

1 Claim, 9 Drawing Sheets

(56) **References Cited**

U.S. PATENT DOCUMENTS

- D316,551 S 4/1991 Ichikawa
- D331,408 S 12/1992 Ellermeier
- D331,966 S 12/1992 Gardner, Jr.
- D337,587 S 7/1993 Nakayama
- D349,903 S 8/1994 Nakamura
- D350,354 S 9/1994 Nakamura
- D351,597 S 10/1994 Nakamura

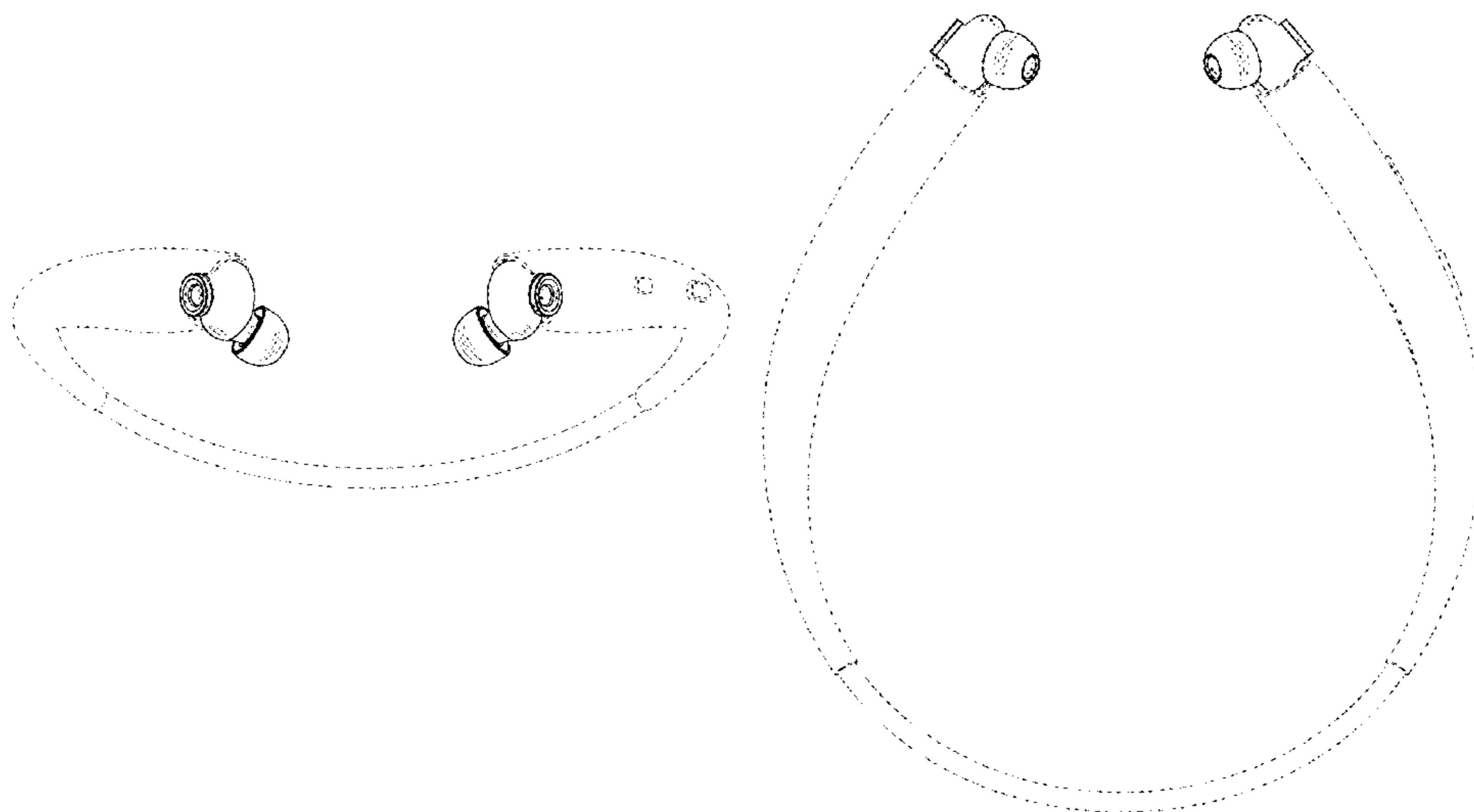

(56)

References Cited

U.S. PATENT DOCUMENTS

D471,176 S 3/2003 Suzuki
 6,603,863 B1* 8/2003 Nagayoshi H04R 1/1066
 381/370
 D492,943 S 7/2004 Komiyama
 D502,463 S 3/2005 Bhakta
 D533,539 S * 12/2006 Mah D14/205
 D575,268 S 8/2008 Christopher et al.
 D585,050 S 1/2009 Gondo
 D587,679 S 3/2009 Komiyama
 D593,067 S * 5/2009 Millora D14/205
 D593,538 S 6/2009 Chon et al.
 D594,442 S * 6/2009 Chon D14/205
 D596,617 S 7/2009 Devlas et al.
 D604,269 S 11/2009 Choe
 D605,182 S 12/2009 Fagnot
 D623,171 S 9/2010 Chen et al.
 D627,766 S 11/2010 Arimoto
 D628,193 S 11/2010 Zheng
 D637,181 S 5/2011 Fuller et al.
 D653,234 S * 1/2012 Lee D14/205
 D663,714 S * 7/2012 Kang D14/205
 8,363,875 B2* 1/2013 Ito H04R 1/1066
 381/379
 8,433,082 B2* 4/2013 Abolfathi H04R 1/46
 381/151
 D716,759 S 11/2014 Ha et al.
 D721,354 S * 1/2015 Thompson D14/223
 D721,673 S 1/2015 Park et al.
 D726,649 S * 4/2015 Lee D13/103
 D730,867 S 6/2015 Park et al.
 D731,999 S * 6/2015 Cephess D14/205
 D740,786 S * 10/2015 Huang D14/205
 D743,933 S 11/2015 Park et al.
 D745,490 S 12/2015 Zheng

D756,958 S 5/2016 Lee et al.
 D761,233 S 7/2016 Kawaji et al.
 D762,196 S 7/2016 Hsieh et al.
 D762,617 S 8/2016 Park et al.
 D766,869 S 9/2016 Lee et al.
 D768,600 S 10/2016 Chen
 D771,588 S 11/2016 Choe et al.
 D772,843 S 11/2016 Lee et al.
 D772,845 S 11/2016 Lim et al.
 D774,017 S 12/2016 Ahn et al.
 D776,636 S * 1/2017 Lim D14/205
 D777,137 S 1/2017 Erbeus
 D781,815 S 3/2017 Choi et al.
 D781,816 S 3/2017 Choe et al.
 D781,822 S * 3/2017 Morris D14/223
 D783,578 S * 4/2017 Bristol D14/223
 D787,480 S 5/2017 Morris et al.
 D800,089 S 10/2017 Park et al.
 D800,090 S 10/2017 Ahn et al.
 D802,557 S 11/2017 Kumano
 D802,558 S 11/2017 Kim et al.
 D803,186 S 11/2017 Park et al.
 D804,445 S 12/2017 Golnik et al.
 D830,335 S * 10/2018 Shin D14/205
 2016/0098138 A1* 4/2016 Park G06F 3/0416
 345/173
 2017/0195768 A1* 7/2017 Kim H04R 1/1016
 2017/0195773 A1* 7/2017 Morris H04R 1/1058
 2017/0311072 A1* 10/2017 Seo H04R 1/1041

OTHER PUBLICATIONS

“Sony Sbh70 Water Resistant Sports Bluetooth Headset with NFC (Blue)”, <https://www.amazon.com/dp/B00YOAZE3A>, earliest review date of Nov. 9, 2015.

* cited by examiner

FIG. 1

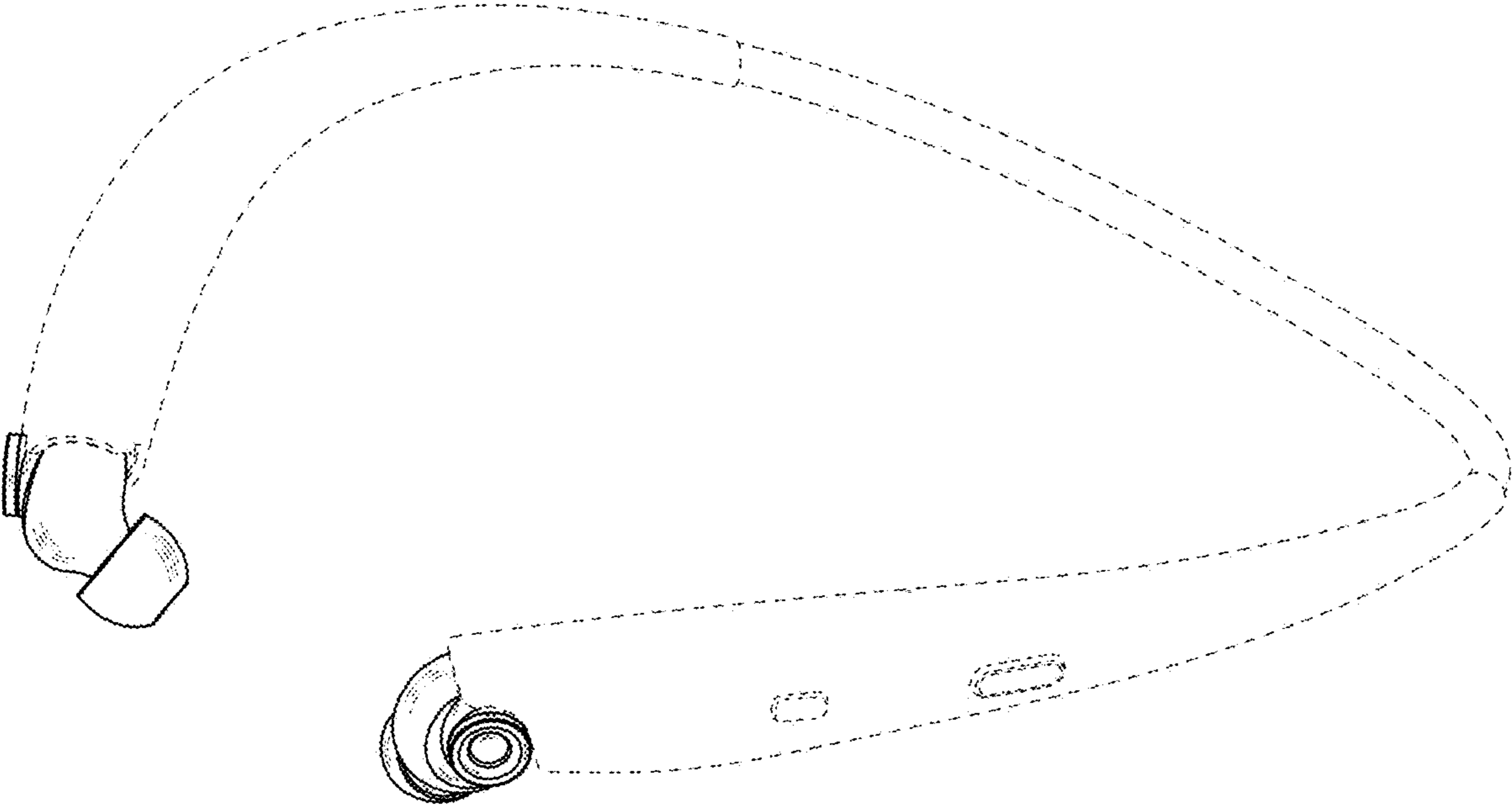

FIG. 2

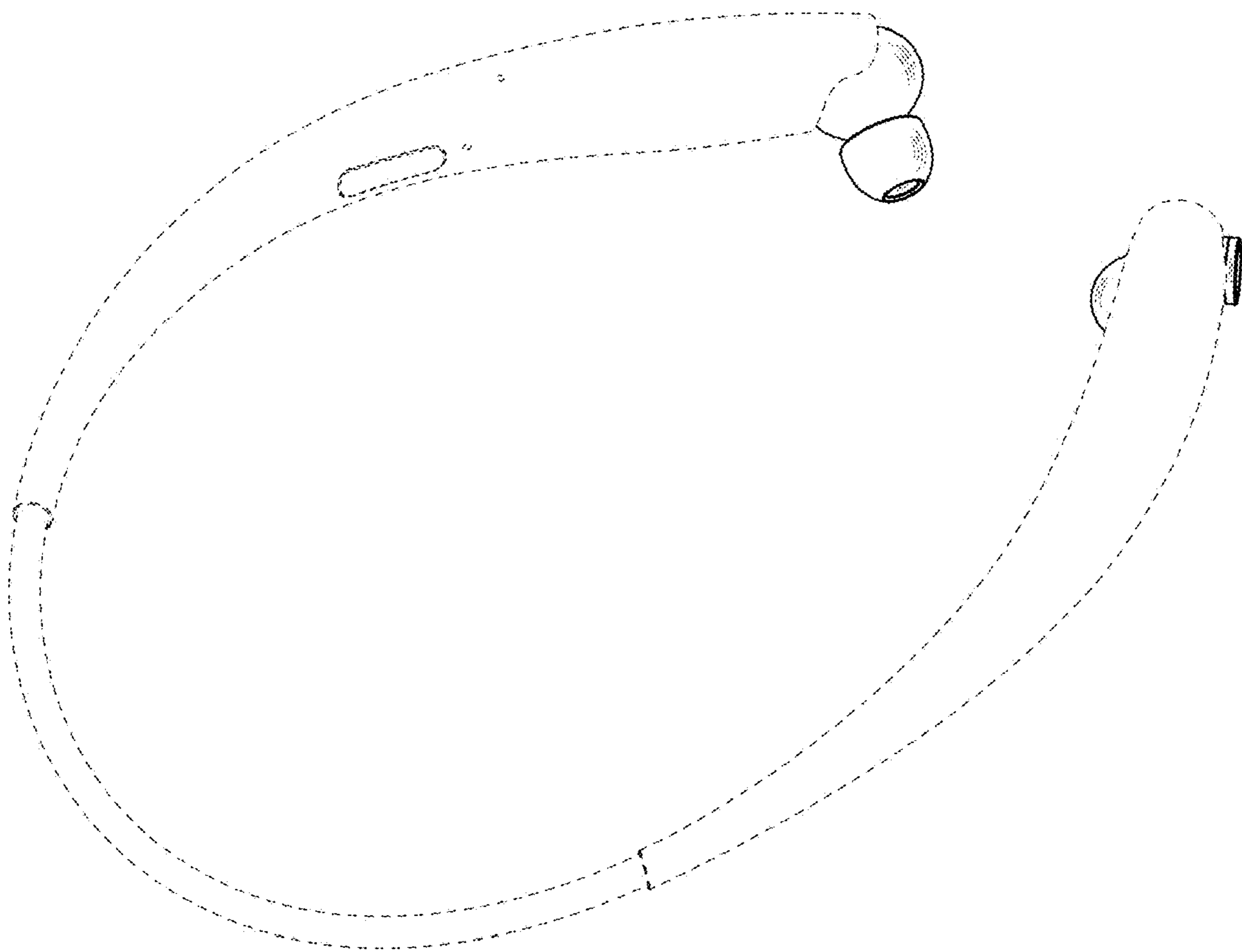

FIG. 3

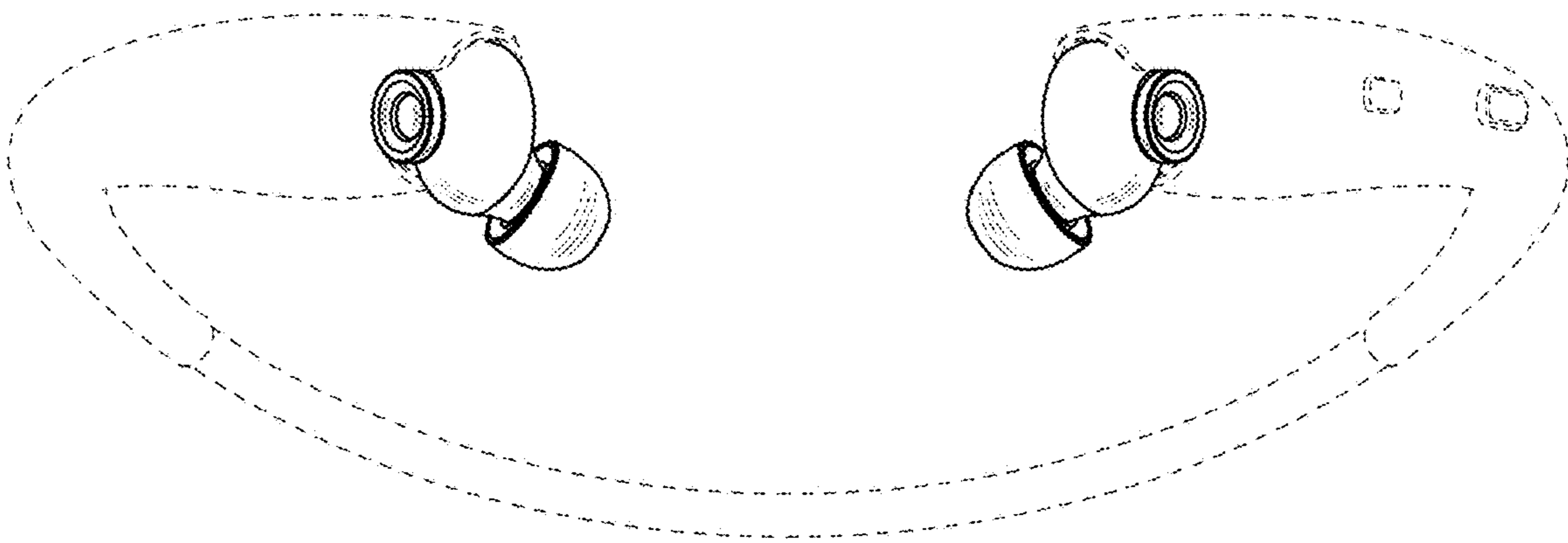

FIG. 4

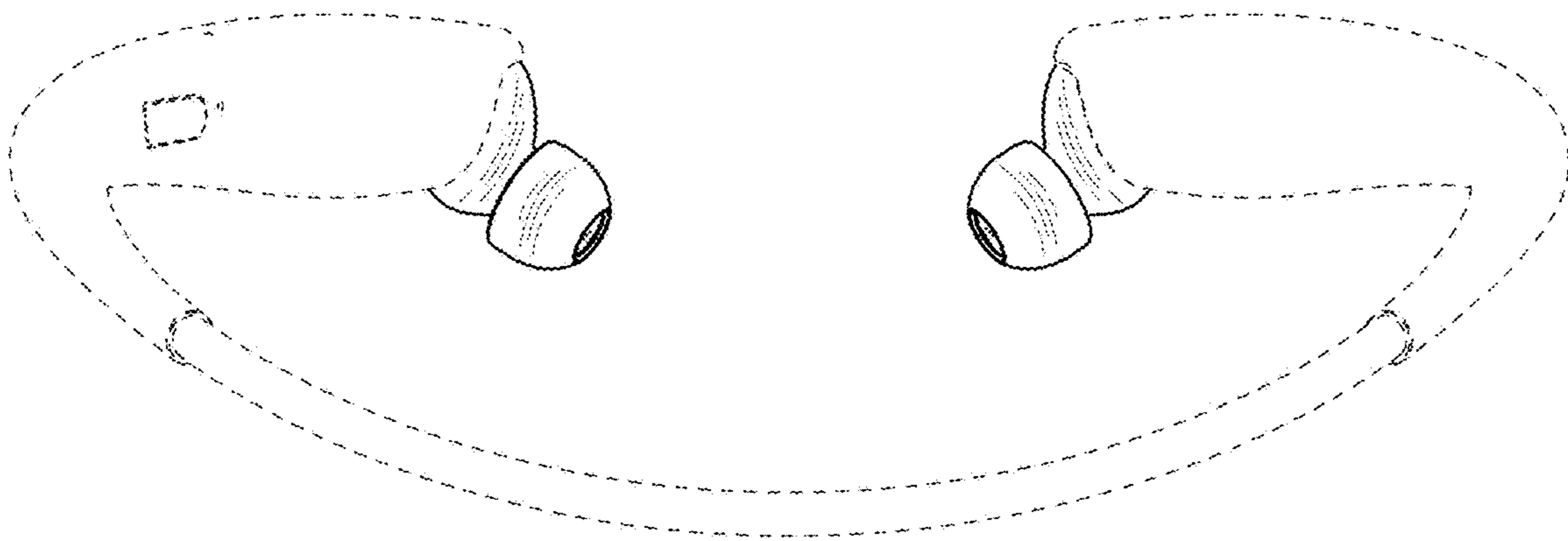

FIG. 5

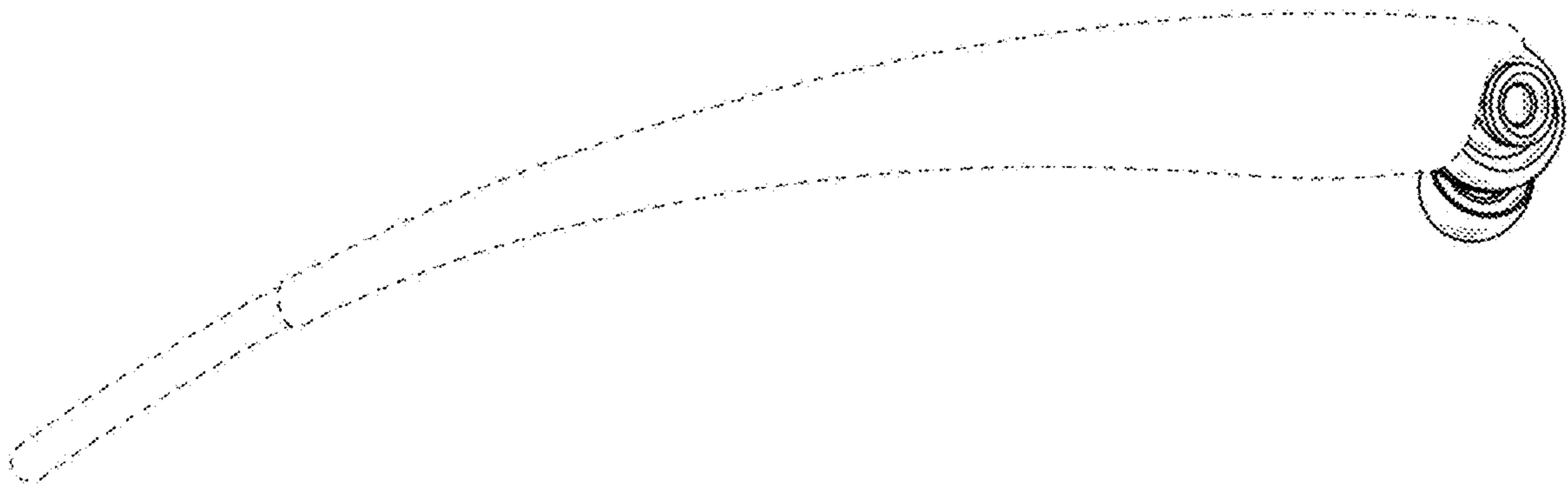

FIG. 6

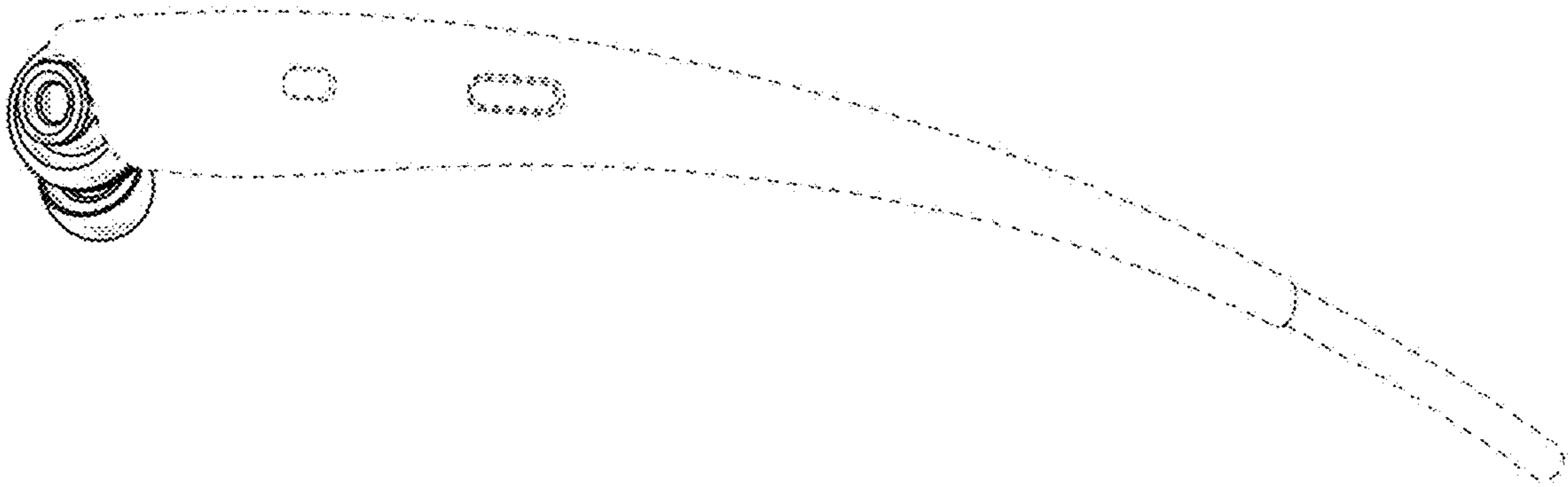

FIG. 7

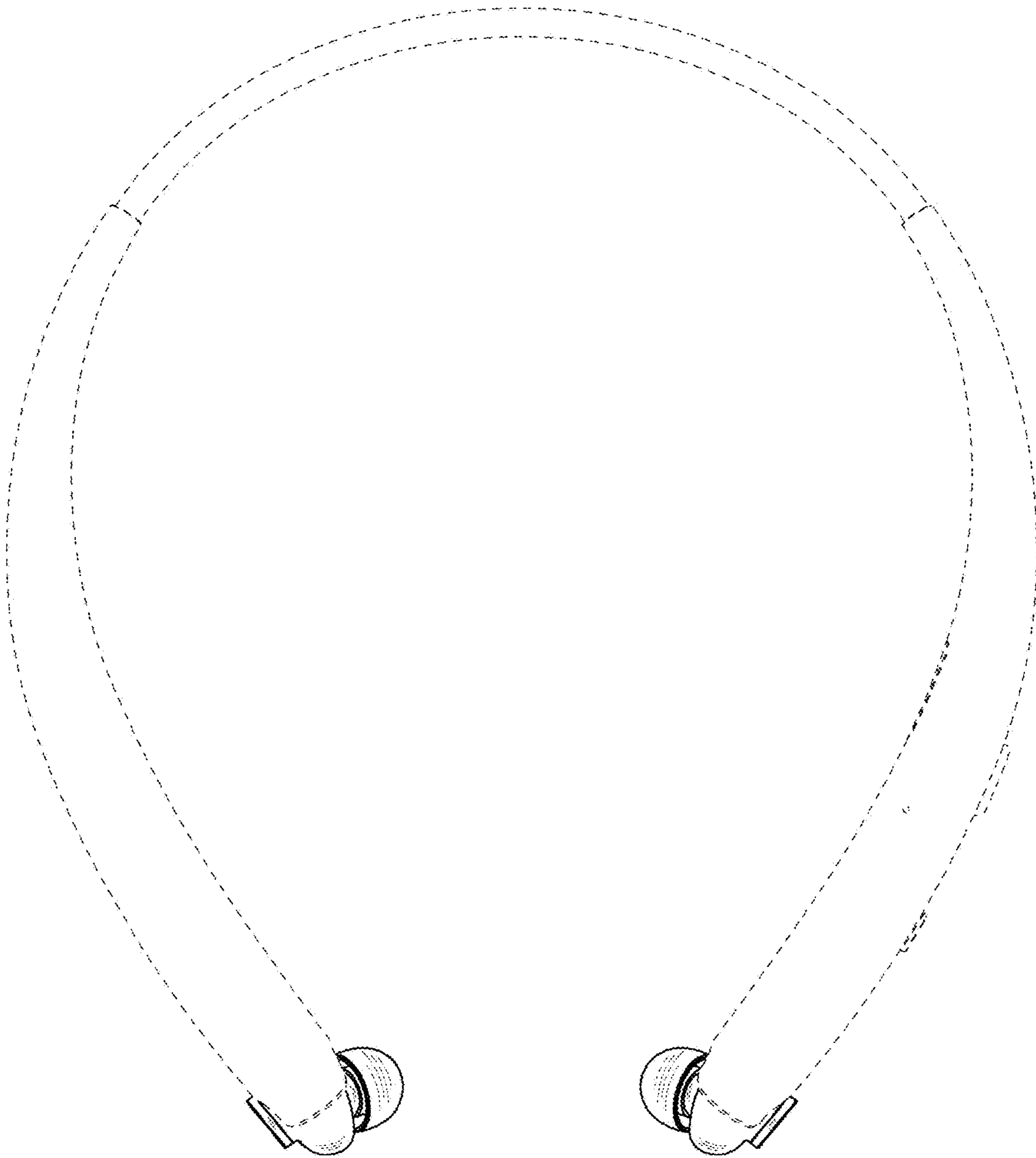

FIG. 8

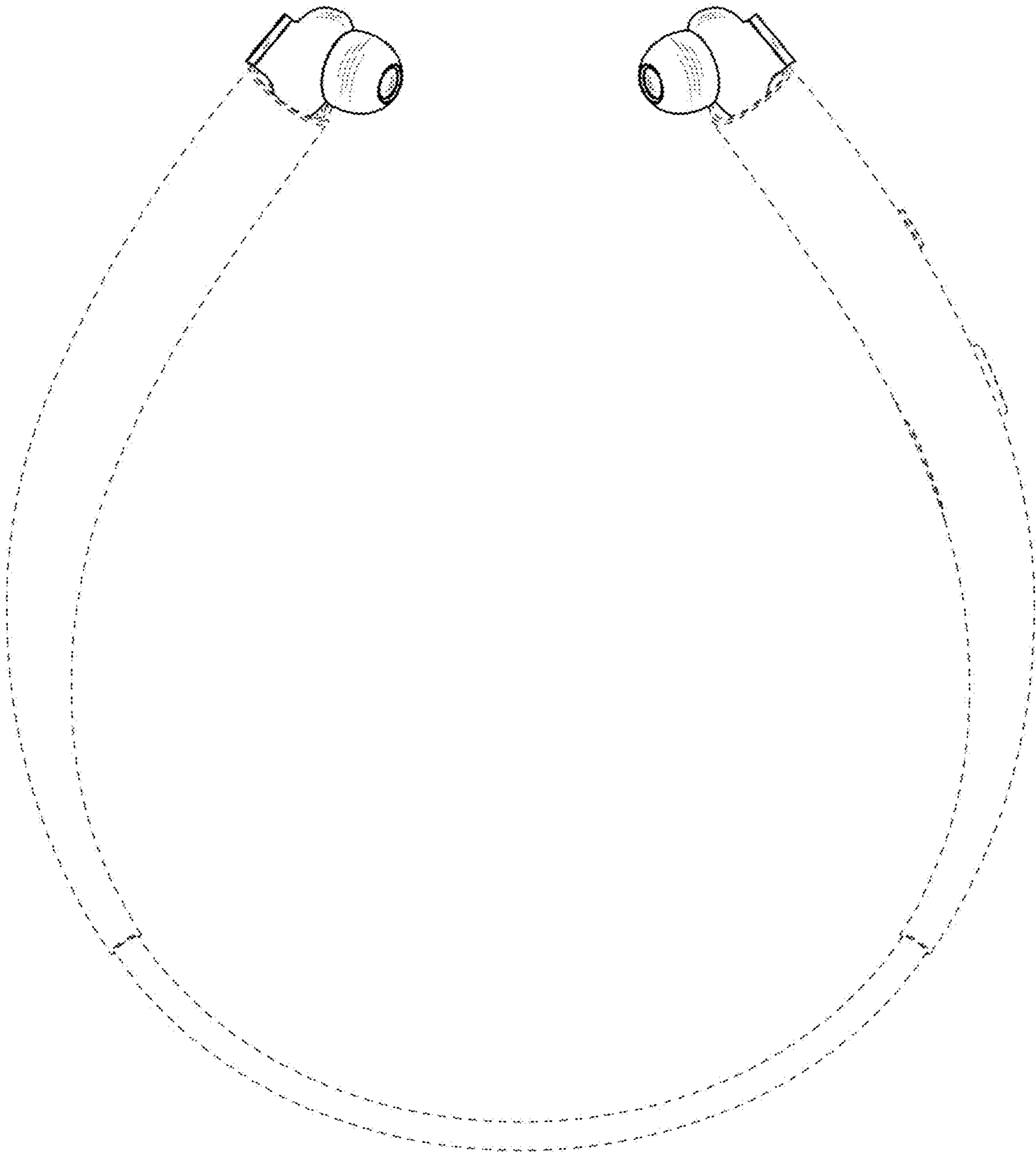

FIG. 9

