



US00D842242S

(12) **United States Design Patent**
Zhang et al.

(10) **Patent No.:** **US D842,242 S**
(45) **Date of Patent:** **** Mar. 5, 2019**

- (54) **WALL-MOUNTED CHARGING PILE**
- (71) Applicant: **Jiangyin SINBON Electronics Co., Ltd.**, Jiangsu (CN)
- (72) Inventors: **Xue-Feng Zhang**, Jiangsu (CN); **Jian Zhou**, Jiangsu (CN)
- (73) Assignee: **Jiangyin Sinbon Electronics Co., Ltd.**, Jiangsu (CN)

D654,858 S *	2/2012	Salazar	D13/107
D654,862 S *	2/2012	Holthusen	D13/107
D664,918 S *	8/2012	Brandys	D13/107
D665,733 S *	8/2012	Petrie	D13/107
D675,563 S *	2/2013	Hoehn	D13/110
D680,952 S *	4/2013	Henderson	D13/108
D686,985 S *	7/2013	Henderson	D13/107
D692,374 S *	10/2013	Choi	D13/107
D711,313 S *	8/2014	Chin-Ho Kim	D13/107
D725,031 S *	3/2015	Tinius	D13/103
D736,716 S *	8/2015	Hough	D13/107

(**) Term: **15 Years**

* cited by examiner

(21) Appl. No.: **29/626,104**

Primary Examiner — Rosemary K Tarca

Assistant Examiner — Nathaniel D. Buckner

(22) Filed: **Nov. 15, 2017**

(74) *Attorney, Agent, or Firm* — Alan D. Kamrath;
Kamrath IP Lawfirm, P.A.

(51) **LOC (11) Cl.** **13-02**

(52) **U.S. Cl.**
USPC **D13/107**

(57) **CLAIM**

(58) **Field of Classification Search**
USPC D13/107–110, 118–119, 184; D14/251,
D14/253, 432, 434
CPC Y02E 60/12; Y02T 90/14; Y02T 90/122;
Y02T 90/128; Y02T 90/163; H02J 7/025;
H02J 7/0042; H02J 7/0044; H02J 7/0045;
H02J 7/0003; H01F 38/14; H01R
13/6675; H01M 2/1022; H01M 2/1055;
H01M 10/44; H01M 10/46; H01M
10/425; B60L 11/182
See application file for complete search history.

The ornamental design for a wall-mounted charging pile, as shown and described.

DESCRIPTION

FIG. 1 is a top right perspective view of a wall-mounted charging pile, showing our new design;
FIG. 2 is a front elevation view thereof;
FIG. 3 is a rear elevation view thereof;
FIG. 4 is a left side elevation view thereof;
FIG. 5 is a right side elevation view thereof;
FIG. 6 is a top plan view thereof; and,
FIG. 7 is a bottom plan view thereof.
The broken lines in the figures depict portions of the article which form no part of the claimed design.

(56) **References Cited**

U.S. PATENT DOCUMENTS

D626,063 S *	10/2010	Cutter	D13/107
D635,938 S *	4/2011	Shimizu	D13/162

1 Claim, 7 Drawing Sheets

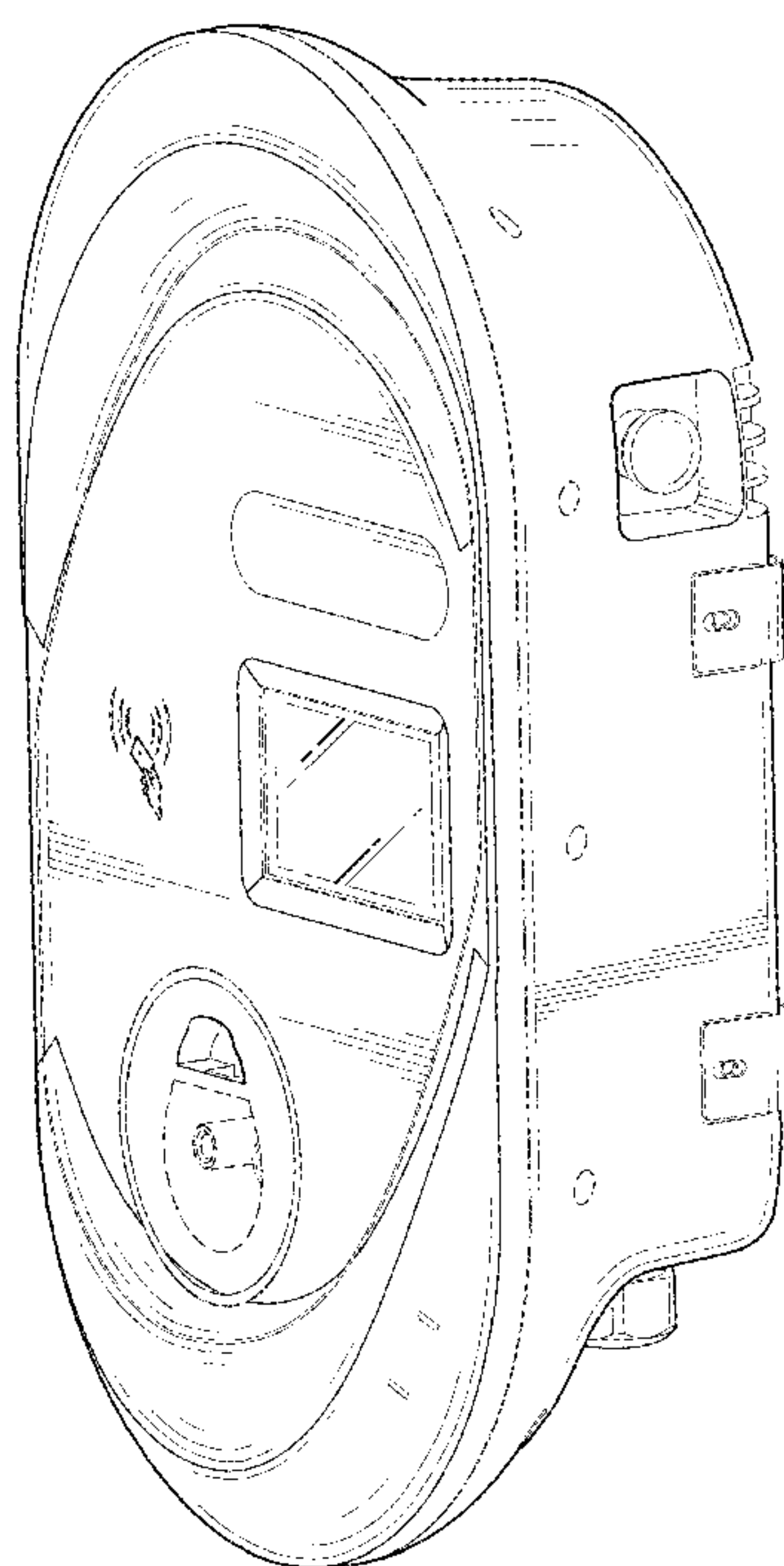

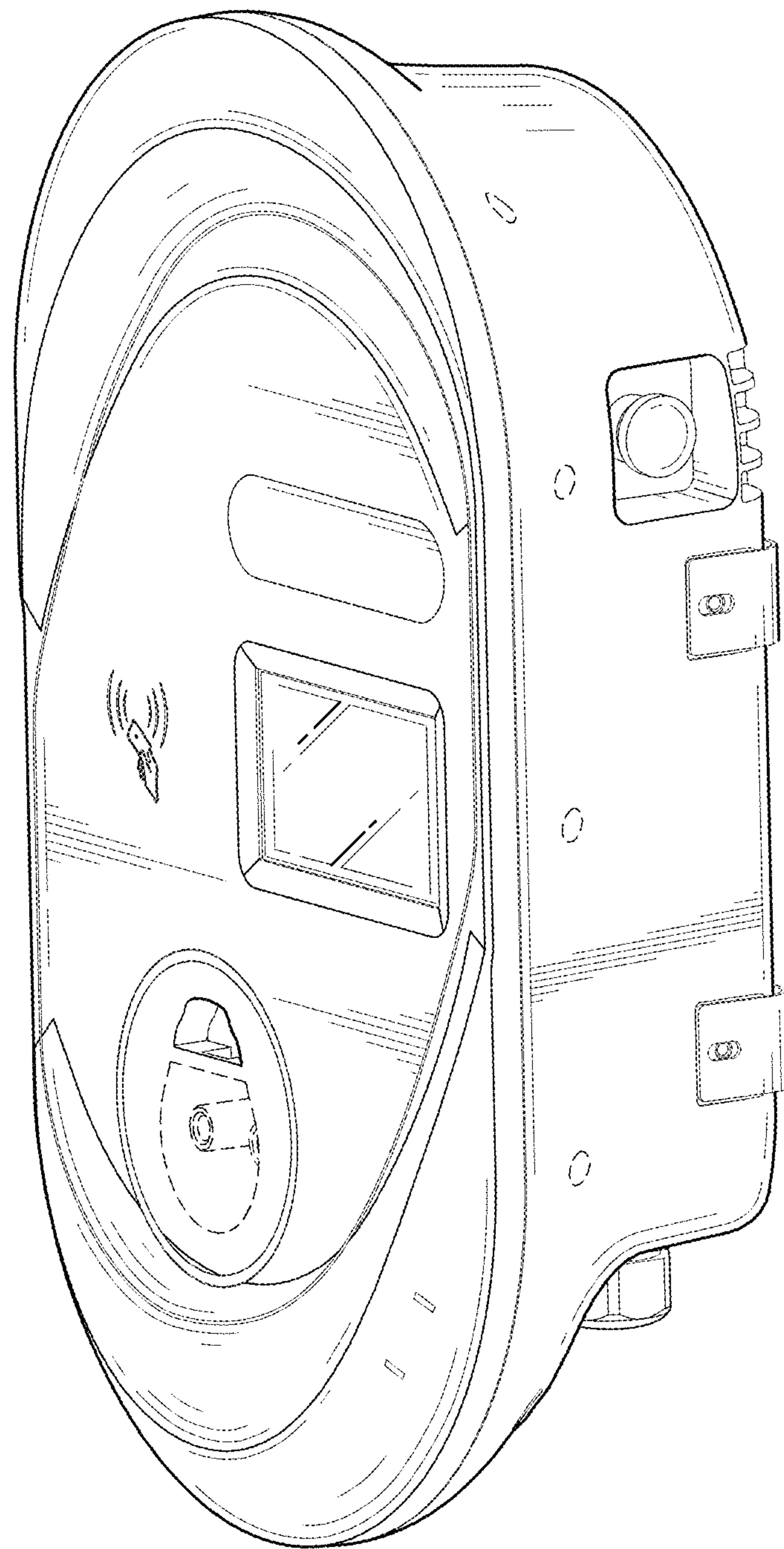

FIG. 1

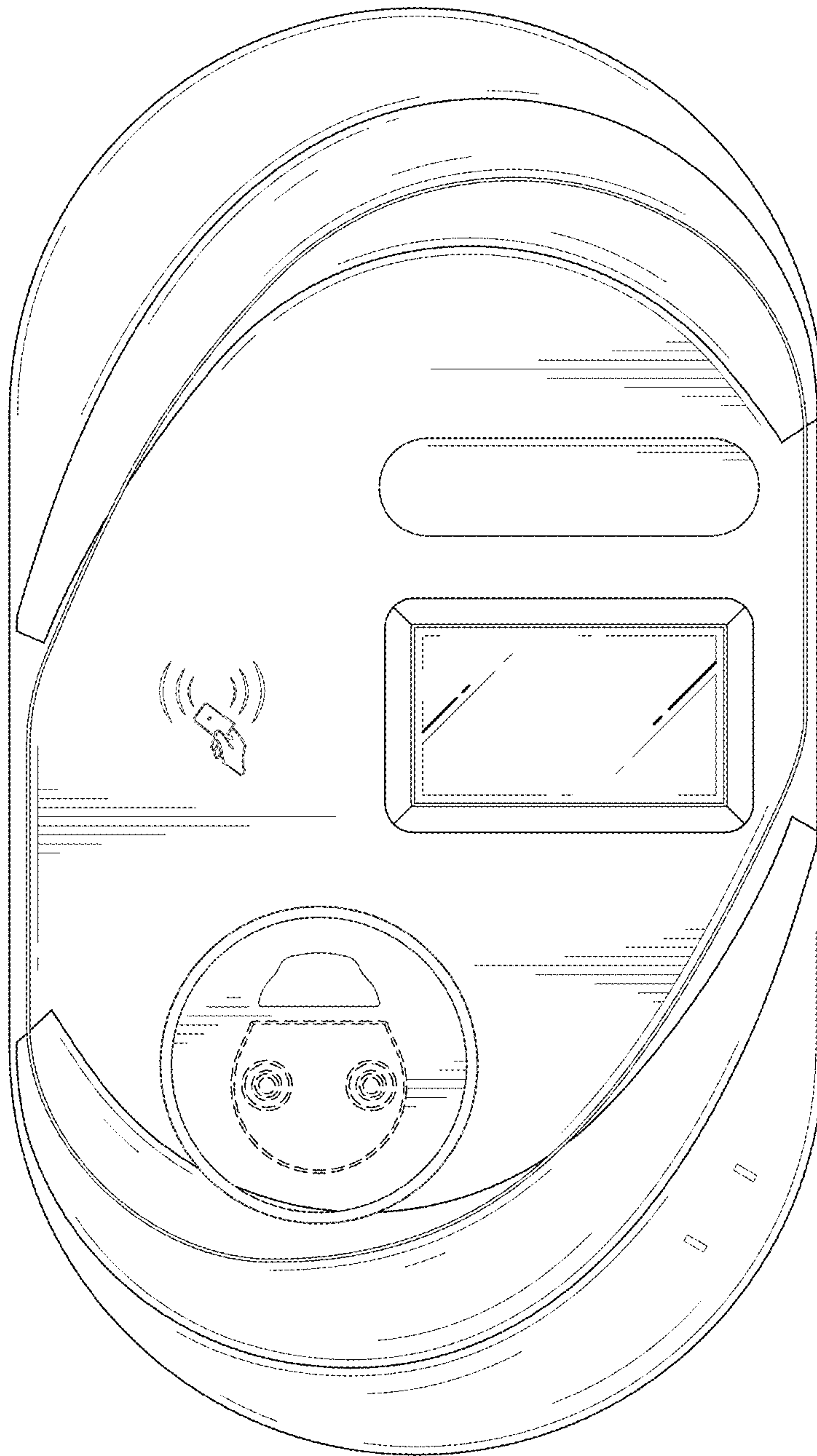

FIG. 2

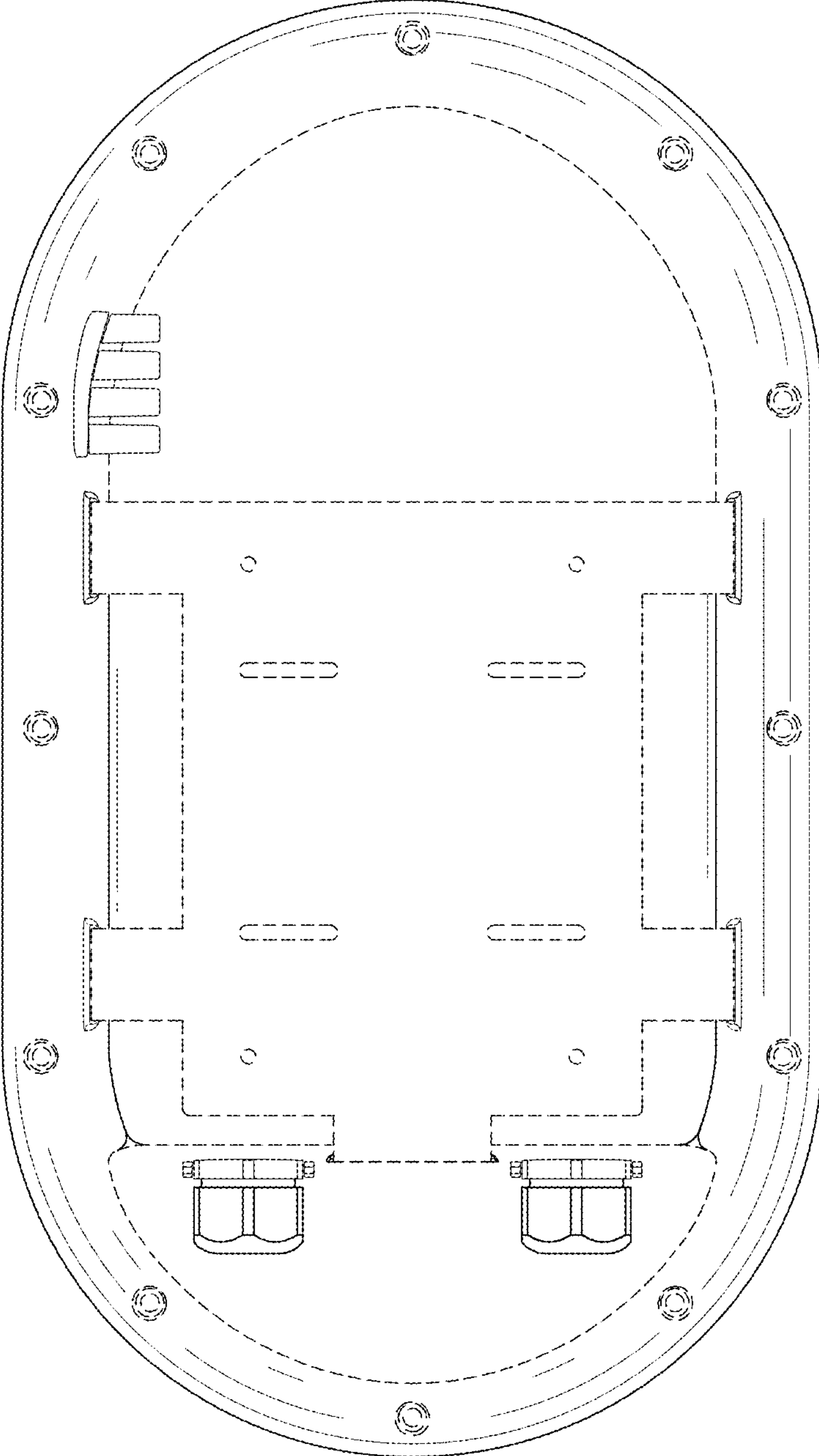

FIG. 3

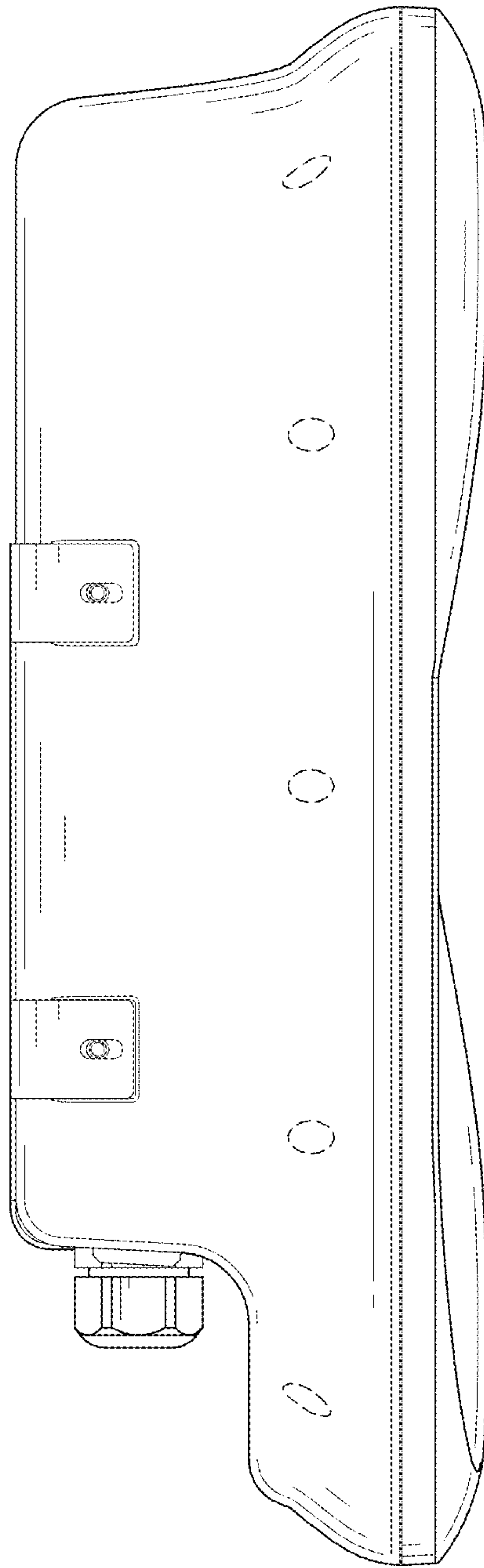

FIG. 4

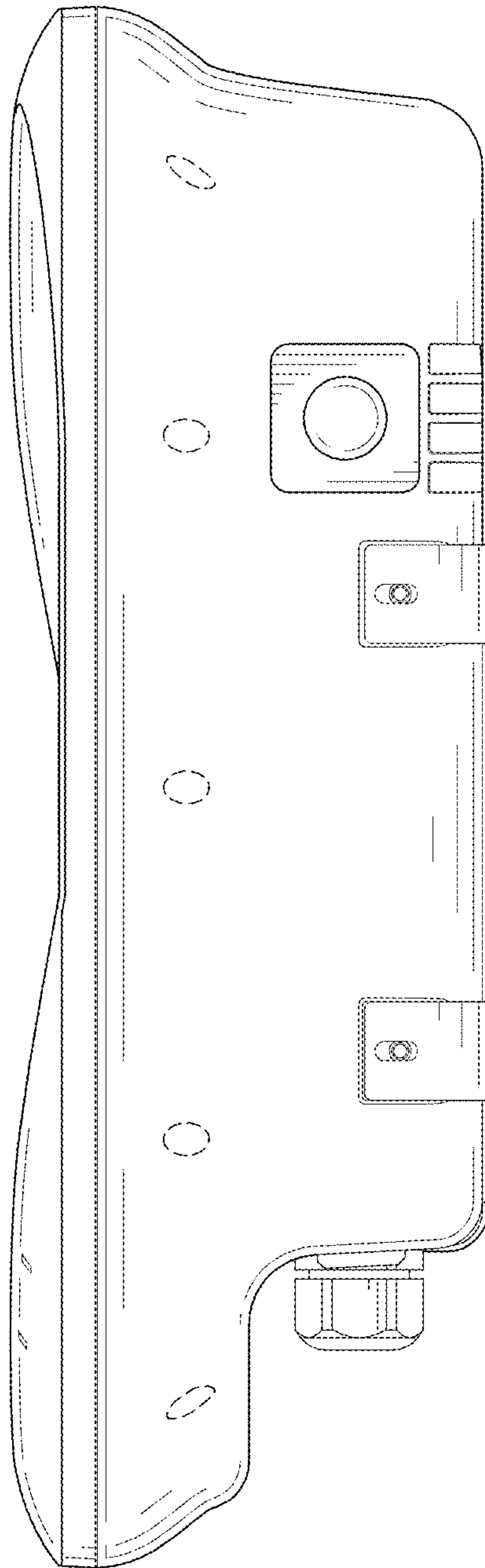

FIG. 5

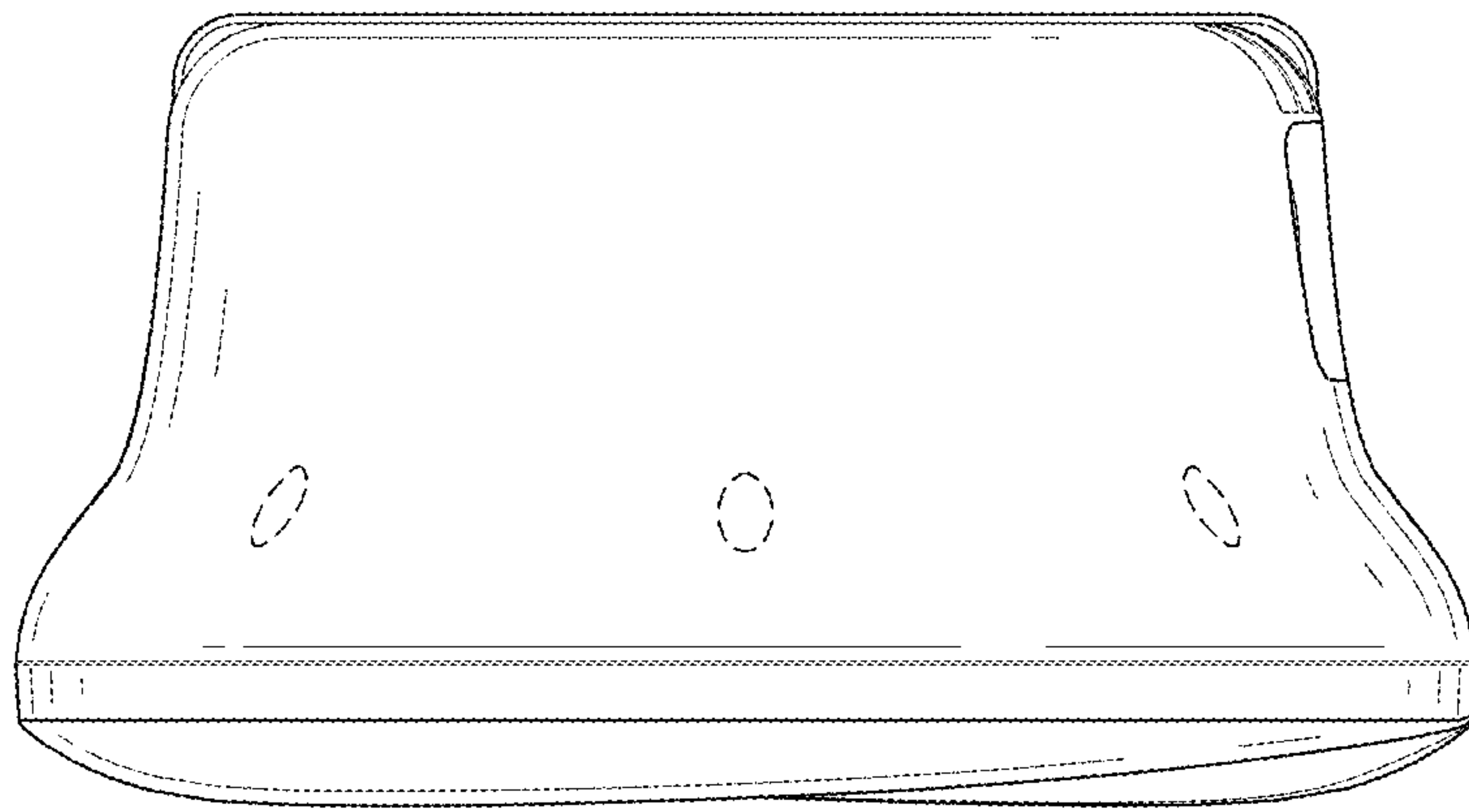

FIG. 6

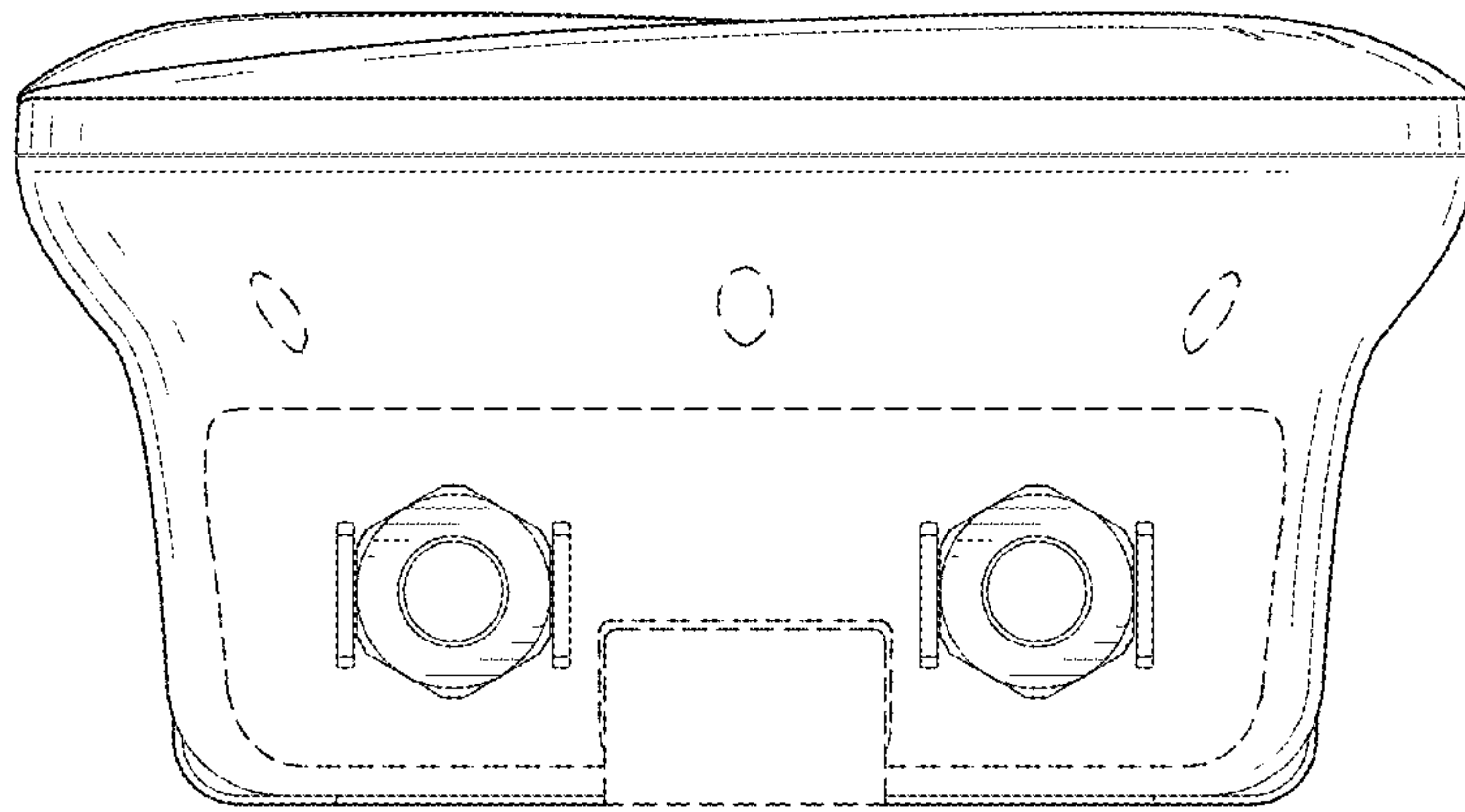

FIG. 7